



**THANK YOU FOR BUYING A WHIRLPOOL PRODUCT**  
In order to receive a more complete assistance, please register your product on [www.whirlpool.eu/register](http://www.whirlpool.eu/register)



**Before using the appliance carefully read the Safety Instruction.**

## PRODUCT DESCRIPTION

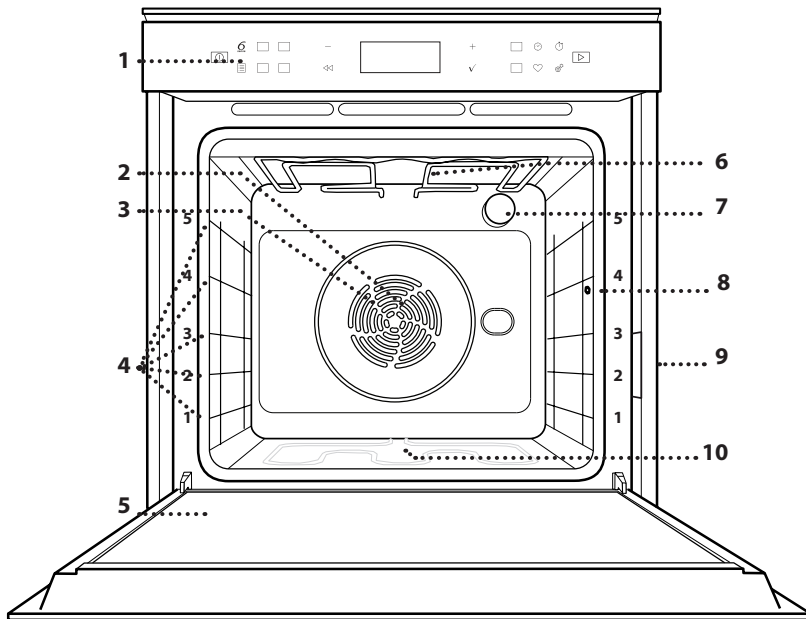

1. Control panel
2. Fan
3. Circular heating element (not visible)
4. Shelf guides (the level is indicated on the front of the oven)
5. Door
6. Upper heating element/grill
7. Lamp
8. Meat probe insert point
9. Identification plate (do not remove)
10. Lower heating element (not visible)

## CONTROL PANEL DESCRIPTION

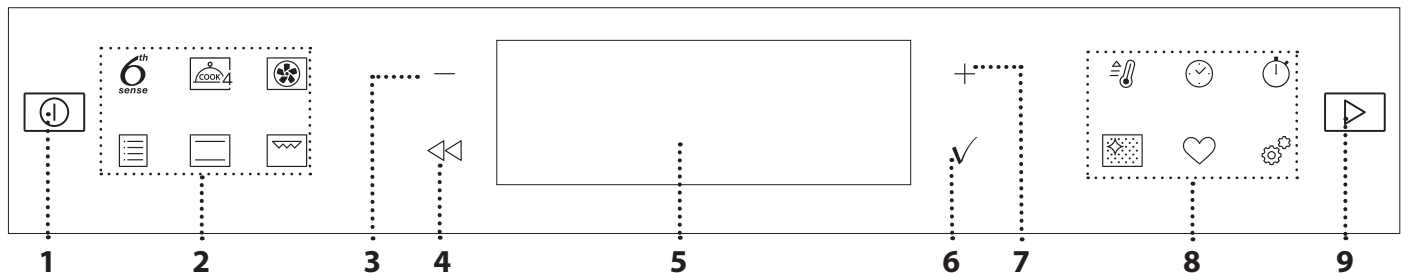

### 1. ON / OFF

For switching the oven on and off and for stopping an active function.

### 2. FUNCTIONS DIRECT ACCESS

For quick access to the functions and menu.

### 3. NAVIGATION BUTTON MINUS

For scrolling through a menu and decreasing the settings or values of a function.

### 4. BACK

For returning to the previous screen.

During cooking, allows settings to be changed.

### 5. DISPLAY

For confirming a selected function or a set value.

### 7. NAVIGATION BUTTON PLUS

For scrolling through a menu and increasing the settings or values of a function.

### 8. OPTIONS / FUNCTIONS DIRECT ACCESS

For quick access to the functions, duration, settings and favorites.

### 9. START

For starting a function using the specified or basic settings.

# ACCESSORIES

## WIRE SHELF



Use to cook food or as a support for pans, cake tins and other ovenproof items of cookware.

## DRIP TRAY

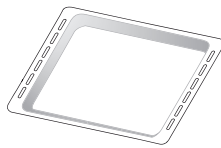

Use as an oven tray for cooking meat, fish, vegetables, focaccia, etc. or position underneath the wire shelf to collect cooking juices.

## BAKING TRAY

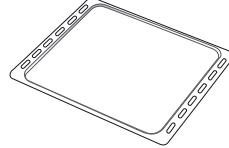

Use for cooking all bread and pastry products, but also for roasts, fish en papillote, etc.

## SLIDING RUNNERS\*

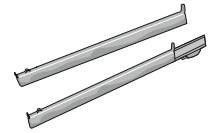

To facilitate inserting or removing accessories.

## MEAT PROBE\*

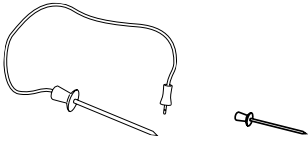

To measure the core temperature of food during cooking.

\* Available only on certain models

The number and the type of accessories may vary depending on which model is purchased.

Other accessories can be purchased separately from the After-sales Service.

## INSERTING THE WIRE SHELF AND OTHER ACCESSORIES

Insert the wire shelf horizontally by sliding it across the shelf guides, making sure that the side with the raised edge is facing upwards.

Other accessories, such as the drip tray and the baking tray, are inserted horizontally in the same way as the wire shelf.

## REMOVING AND REFITTING THE SHELF GUIDES

- To remove the shelf guides, lift the guides up and then gently pull the lower part out of its seating: The shelf guides can now be removed.
- To refit the shelf guides, first fit them back into their upper seating. Keeping them held up, slide them into the cooking compartment, then lower them into position in the lower seating.

## FITTING THE SLIDING RUNNERS (IF PRESENT)

Remove the shelf guides from the oven and remove the protective plastic from the sliding runners.

Fasten the upper clip of the runner to the shelf guide and slide it along as far as it will go. Lower the other clip into position.

To secure the guide, press the lower portion of the clip firmly against the shelf guide. Make sure that the runners can move freely. Repeat these steps on the other shelf guide on the same level.

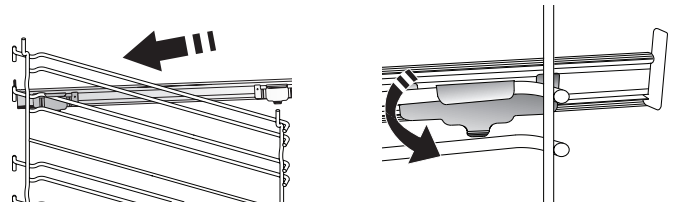

Please note: The sliding runners can be fitted on any level.

## USING THE MEATPROBE (IF PRESENT)



Insert the food probe deep into the meat, avoiding bones or fatty areas. For poultry, insert the probe lengthways into the centre of the breast, avoiding hollow areas.

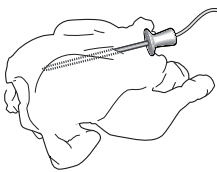

Place the food in the oven and connect the plug by inserting it into the connection provided on the righthand side of the oven's cooking compartment.



## FUNCTIONS



### 6<sup>th</sup> SENSE

These allow a fully automatic cooking for all types of food (Lasagna, Meat, Fish, Vegetables, Cakes & Pastries, Salt cakes, Bread, Pizza).

To get the best from this function, follow the indications on the relative cooking table.



### COOK 4

For cooking different foods that require the same cooking temperature on four levels at the same time. This function can be used to cook cookies, cakes, round pizzas (also frozen) and to prepare a complete meal. Follow the cooking table to obtain the best results.



### FORCED AIR

For cooking different foods that require the same cooking temperature on several shelves (maximum three) at the same time. This function can be used to cook different foods without odours being transferred from one food to another.



### TRADITIONALS

#### • CONVECT BAKE

For cooking meat, baking cakes with fillings on one shelf only.

#### • TURBO GRILL

For roasting large joints of meat (legs, roast beef, chicken). We recommend using a drip tray to collect the cooking juices: Position the pan on any of the levels below the wire shelf and add 500 ml of drinking water.

#### • FROZEN BAKE

The function automatically selects the ideal cooking temperature and mode for 5 different types of ready frozen food. The oven does not have to be preheated.

#### • SPECIAL FUNCTIONS

##### » MAXI COOKING

The function automatically selects the best cooking mode and temperature to cook large joints of meat (above 2.5 kg). It is advisable to turn the meat over during cooking, to obtain even browning on both sides. It is best to baste the meat every now and again to prevent it from drying out.

##### » RISING

For optimal proving of sweet or savoury dough. To maintain the quality of proving, do not activate the function if the oven is still hot following a cooking cycle.

##### » DEFROSTING

To speed up defrosting of food. Place food on the middle shelf. Leave food in its packaging to prevent it from drying out on the outside.

##### » KEEP WARM

For keeping just-cooked food hot and crisp.

##### » ECO FORCED AIR

For cooking stuffed roasting joints and fillets of meat on a single shelf. Food is prevented from drying out excessively by gentle, intermittent air circulation. When this ECO function is in use, the light will remain switched off during cooking. To use the ECO cycle and therefore optimise power consumption, the oven door should not be opened until the food is completely cooked.



### CONVENTIONAL

For cooking any kind of dish on one shelf only.



### GRILL

For grilling steaks, kebabs and sausages, cooking vegetables au gratin or toasting bread. When grilling meat, we recommend using a drip tray to collect the cooking juices: Position the tray on any of the levels below the wire shelf and add 500 ml of drinking water.



### FAST PREHEAT

For preheating the oven quickly.



### TIMERS

For editing function time values.



### MINUTEMINDER

For keeping time without activating a function.



### AUTOMATIC OVEN CLEANING - PYRO

For eliminating cooking spatters using a cycle at very high temperature. Two selfcleaning cycles are available: A complete cycle (Pyro) and a shorter cycle (Pyro Eco). We recommend using the quicker cycle at regular intervals and the complete cycle only when the oven is heavily soiled.



### FAVORITE

For retrieving the list of 10 favorite functions.



### SETTINGS

For adjusting the oven settings.

When "ECO" mode is active the brightness of the display will be reduced to save energy and lamp switches off after 1 minute. It will be reactivated automatically whenever any of the buttons are pressed.

When "DEMO" is "On" all commands are active and menus available but the oven doesn't heat up. To deactivate this mode, access "DEMO" from "SETTINGS" menu and select "Off".

By selecting "FACTORY RESET", the product switches off and then it returns to first switch on. All settings will be deleted.

# FIRST TIME USE

## 1. SELECT THE LANGUAGE

You will need to set the language and the time when you switch on the appliance for the first time: "English" will show on the display.



Press + or – to scroll through the list of available languages and select the one you require. Press ✓ to confirm your selection.

Please note: The language can subsequently be changed by selecting "LANGUAGE" in "SETTINGS" menu, available by pressing ⚙️.

## 2. SET THE POWER CONSUMPTION

The oven is programmed to consume a level of electrical power that is compatible with a domestic network that has a rating of more than 3 kW (16): If your household uses a lower power, you will need to decrease this value (13).

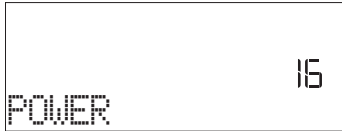

Press + or – to select 16 "High" or 13 "Low" and press ✓ to confirm.

## 3. SET THE TIME

After selecting the power, you will need to set the current time: The two digits for the hour will flash on the display.



Press + or – to set the current hour and press ✓: The two digits for the minutes will flash on the display. Press + or – to set the minutes and press ✓ to confirm.

Please note: You may need to set the time again following lengthy power outages. Select "CLOCK" in "SETTINGS" menu, available by pressing ⚙️.

## 4. HEAT THE OVEN

A new oven may release odours that have been left behind during manufacturing: this is completely normal. Before starting to cook food, we therefore recommend heating the oven with it empty in order to remove any possible odours. Remove any protective cardboard or transparent film from the oven and remove any accessories from inside it. Heat the oven to 200 °C for around one hour, ideally using a function with air circulation (e.g. "Forced Air" or "Convection Bake").

Please note: It is advisable to air the room after using the appliance for the first time.

# DAILY USE

## 1. SELECT A FUNCTION

Press ⏻ to switch on the oven: the display will show the last running main function or the main menu.

The functions can be selected by pressing the icon for one of the main functions or by scrolling through a menu: To select an item from a menu (the display will show the first available item), press + or – to select the desired one, then press ✓ to confirm.

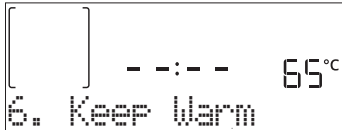

## 2. SET THE FUNCTION

After having selected the function you require, you can change its settings. The display will show the settings that can be changed in sequence. Pressing ⏪ allows you to change the previous setting again.

### TEMPERATURE / GRILL LEVEL

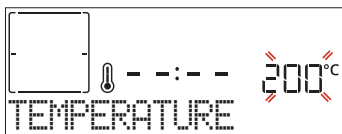

When the value flashes on the display, press + or – to

change it, then press ✓ to confirm and continue with the settings that follow (if possible).

In the same way, it is possible to set the grill level: There are three defined power levels for grilling: 3 (high), 2 (mid), 1 (low).

Please note: Once the function has been activated, the temperature/grill level can be changed using + or –.

### DURATION

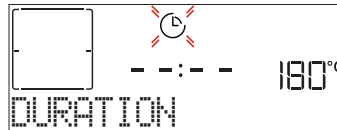

When the ⌚ icon flashes on the display, press + or – to set the cooking time you require and then press ✓ to confirm. You do not have to set the cooking time if you want to manage cooking manually (untimed): Press ✓ or ⏻ to confirm and start the function. By selecting this mode, you cannot program a delayed start.

Please note: You can adjust the cooking time that has been set during cooking by pressing ⌚: press + or – to amend it and then press ✓ to confirm.

## END TIME (START DELAY)

In many functions, once you have set a cooking time you can delay starting the function by programming its end time. The display shows the end time while the  icon flashes.



Press **+** or **-** to set the time you want cooking to end, then press **✓** to confirm and activate the function. Place the food in the oven and close the door: The function will start automatically after the period of time that has been calculated in order for cooking to finish at the time you have set.

Please note: Programming a delayed cooking start time will disable the oven preheating phase: The oven will reach the temperature you require gradually, meaning that cooking times will be slightly longer than those listed in the cooking table. During the waiting time, you can press **+** or **-** to amend the programmed end time or press **◀** to change other settings. By pressing , in order to visualize information, it is possible to switch between end time and duration.

## 6<sup>th</sup> SENSE

These functions automatically select the best cooking mode, temperature and duration to cook, roast or bake all the dishes available.

When required, simply indicate the characteristic of food to obtain an optimal result.

### WEIGHT / HEIGHT (ROUND-TRAY-LAYERS)



To set the function correctly, follow the indications on the display, when prompted, and press **+** or **-** to set the required value then press **✓** to confirm.

### DONENESS / BROWNING

In some 6<sup>th</sup> Sense functions it is possible to adjust the doneness level.



When prompted, press **+** or **-** to select the desired level between rare (-1) and well done (+1). Press **✓** or  to confirm and start the function.

In the same way, where allowed, in some 6<sup>th</sup> Sense functions, it's possible to adjust the browning level between low (-1) and high (+1).

## 3. START THE FUNCTION

At any time, if the default values are those desired or once you have applied the settings you require, press  to activate the function.

During the delay phase, press  to skip this phase

and start the function immediately.

Please note: Once a function has been selected, the display will recommend the most suitable level for each function. At any time you can stop the function that has been activated by pressing .

If the oven is hot and the function requires a specific maximum temperature, a message will shown on the display. Press **◀** to return to previous screen and select a different function or wait for a complete cooling.

## 4. PREHEATING

Some functions have an oven preheating phase: Once the function has started, the display indicates that the preheating phase has been activated.



Once this phase has finished, an audible signal will sound and the display will indicate that the oven has reached the set temperature, requiring to "ADD FOOD". At this point, open the door, place the food in the oven, close the door and start cooking by pressing **✓** or .

Please note: Placing the food in the oven before preheating has finished may have an adverse effect on the final cooking result. Opening the door during the preheating phase will stop pause it.

The cooking time does not include a preheating phase. You can always change the temperature you want the oven to reach using **+** or **-**.

## 5. PAUSE COOKING / TURN OR CHECK FOOD

By opening the door, the cooking will be temporarily paused through deactivating heating elements.

To resume the cooking, close the door.

Some 6<sup>th</sup> Sense functions will require the food to be turned during cooking.



An audible signal will sound and the display shows the action to be done. Open the door, do the action prompted by the display and close the door, then press  to continue cooking.

In the same way, at 10% of time before the end of cooking, the oven prompts you to check the food.



An audible signal will sound and the display shows the action to be done. Check the food, close the door and press  or **✓** to continue cooking.

Please note: Press  to skip these actions. Otherwise, if no action is done after a certain time the oven will continue the cooking.

## 6. END OF COOKING

An audible signal will sound and the display will indicate that cooking is complete.

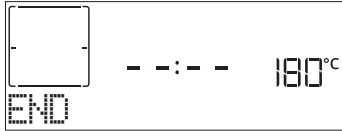

Press to continue cooking in manual mode (untimed) or press to extend the cooking time by setting a new duration. In both cases, the cooking parameters will be retained.

## BROWNING

Some functions of the oven enable you to brown the surface of the food by activating the grill once cooking is complete.

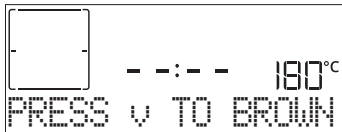

When the display shows the relevant message, if required press to start a five-minute browning cycle. You can stop the function at any time by pressing to switch the oven off.

## FAVORITES

Once cooking is complete the display will prompt you to save the function in a number between 1 and 10 on your list of favorites.

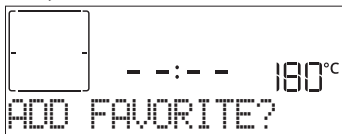

If you would like to save a function as a favorite and store the current settings for future use, press otherwise, to ignore the request press .

Once has been pressed, press the or to select the number position, then press to confirm.

Please note: If the memory is full or the number chosen has already been taken, the oven will ask you to confirm overwriting the previous function.

To call up the functions you have saved at a later time, press : The display will show your list of favorite functions.



Press or to select the function, confirm by pressing , and then press to activate.

## AUTOMATIC CLEANING – PYRO

**Do not touch the oven during the Pyro cycle. Keep children and animals away from the oven during and after (until the room has finished airing) running the Pyro cycle.**

Remove all accessories - including shelf guides - from the oven before activating the function. If the oven is installed below a hob, make sure that all the

burners or electric hotplates are switched off while running the selfcleaning cycle. For optimum cleaning results, remove excessive residuals inside the cavity and clean the inner door glass before using the Pyro function. We recommend only running the Pyro function if the appliance contains heavy soiling or gives off bad odours during cooking.

Press to show "Pyro" on the display.

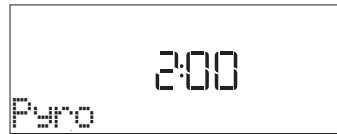

Press or to select the desired cycle, then press to confirm. Once a cycle has been selected, if desired, press or to set end time (start delay), then press to confirm.

Clean the door and remove all accessories as prompted, then close the door and press when done: the oven will begin the self-cleaning cycle, while the door locks automatically: a warning message appears on the display, along with a countdown indicating the status of the cycle in progress.

Once the cycle has been completed, the door remains locked until the temperature inside the oven has returned to a safe level.

## MINUTEMINDER

When the oven is switched off, the display can be used as a timer. To activate this function, make sure that the oven is switched off and press or : The icon will flash on the display.

Press or to set the length of time you require and then press to activate the timer.

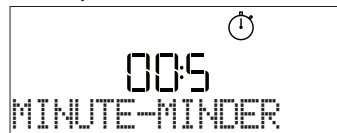

An audible signal will sound and the display will indicate once the minuteminder has finished counting down the selected time.

Please note: The minuteminder does not activate any of the cooking cycles. Press or to change the time set on the timer.

Once the minuteminder has been activated, you can also select and activate a function.

Press to switch on the oven and then select the function you require.

Once the function has started, the timer will continue to count down independently without interfering with the function itself.

Please note: During this phase, it isn't possible to see the minuteminder (only the icon will be displayed), that will continue counting down in background. To retrieve the minuteminder screen press to stop the function that is currently active.

## KEYLOCK

To lock the keypad, press and hold ⏏ for at least five seconds. Do this again to unlock the keypad.



Please note: This function can also be activated during cooking. For safety reasons, the oven can be switched off at any time by pressing [0].

## USING THE MEAT PROBE (IF PRESENT)

Using the probe enables you to measure the core temperature of the meat during cooking to ensure that it reaches the optimum temperature. The temperature of the oven varies according to the function that you have selected, but cooking is always programmed to finish once the specified temperature has been reached. Once you have inserted the probe, an audible signal is activated and "Probe Plugged" appears on the display.



Select the function you require from those that are

compatible (Conventional, Forced Air, Convection Bake, Turbogrill, Eco Forced Air, Maxi Cooking, 6<sup>th</sup> Sense functions): The display prompts to set the target temperature of the probe: Press + or - to set it and press ✓ to set the following cooking parameters.

As cooking is programmed to finish once the required temperature has been reached, it is not possible to set the cooking time or set a specific time for cooking to end. The light will remain switched on until the probe is removed.

If the probe is removed during cooking, it will continue by the traditional mode (untimed).

An audible signal will sound and the display will indicate when the probe has reached the required temperature.

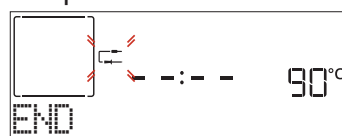





































Please note: To change the settings subsequently, press + or - for the probe temperature or press ⏏ for other settings.

An audible signal and a message will tell you if use of the probe is not compatible with the action done. If this is the case, remove the probe.

## 6<sup>th</sup> sense COOKING TABLE

FOOD CATEGORIES		QUANTITY	TURN (OF COOK TIME)	LEVEL AND ACCESSORIES
LASAGNA	-	0.5 - 3 kg	-	2
MEAT	Beef-roasted	Roast (doneness 0)	0.6 - 2 kg **	3
		Hamburgers (doneness 0)	1.5 - 3 cm	5  4
		Roast-Slow cooking (doneness 0) *	0.6 - 2 kg **	3
	Pork-roasted	Roast	0.6 - 2.5 kg **	3
		Shank *	0.5 - 2.0 kg **	3
		Sausages & wurstel	1.5 - 4 cm	5  4
	Veal-roasted *		0.6 - 2.5 kg **	3
	Lamb-roasted	Roast (doneness 0) *	0.6 - 2.5 kg **	2
		Leg (doneness 0) *	0.5 - 2.0 kg **	2
	Chicken-roasted	Whole	0.6 - 3 kg **	2
		Whole stuffed *	0.6 - 3 kg **	2
		Fillet & breast	1 - 5 cm	5  4
	Whole turkey-roasted	Whole *	0.6 - 3 kg **	2
		Whole stuffed *	0.6 - 3 kg **	2
Kebabs		1 grid	5  4	



FOOD CATEGORIES		QUANTITY	TURN (OF COOK TIME)	LEVEL AND ACCESSORIES	
FISH	Fillets	0.5 - 3 cm	-	3  2 	
	Fillets-frozen	0.5 - 3 cm	-	3  2 	
VEGETABLES	Vegetables-roasted	Potatoes	0.5 - 1.5 kg	-	3 
		Vegetables-stuffed	0.1 - 0.5 kg each	-	3 
		Vegetables-roasted	0.5 - 1.5 kg	-	3 
	Vegetables-gratin	Potatoes	1 tray	-	3 
		Tomatoes	1 tray	-	3 
		Peppers	1 tray	-	3 
		Broccoli	1 tray	-	3 
		Cauliflowers	1 tray	-	3 
Others	1 tray	-	3 		
CAKES & PASTRIES	Rising cakes in tin	Sponge Cake	0.5 - 1.2 kg	-	3 
	Pastries & filled pies	Cookies	0.2 - 0.6 kg	-	3 
		Choux pastry	1 tray	-	3 
		Tart	0.4 - 1.6kg	-	3 
		Strudel	0.4 - 1.6kg	-	3 
		Fruit filled pie	0.5 - 2 kg	-	3 
QUICHES	-	0.8 - 1.2 kg	-	2 	
BREAD	Rolls	60 - 150 g each	-	3 	
	Sandwich Loaf in tin	400 - 600g each	-	2 	
	Big bread	0.5 - 2.0 kg	-	2 	
	Baguettes	200 - 300g each	-	3 	
PIZZA	Thin	round - tray	-	2 	
	Thick	round - tray	-	2 	
	Frozen	1 - 4 layers	-	2 	
				4  2 	
					5  3  1 
					5  3  2  1 

\* Only in some models. Function available only in combination with the Meat probe.

\*\* Suggested quantity.

ACCESSORIES

 Wire shelf

 Oven tray or cake tin on wire shelf





























































































 Drip tray / Baking tray or oven tray on wire shelf

 Drip tray / Baking tray

 Drip tray with 500 ml of water

 Meat probe (if supplied)

# COOKING TABLE

RECIPE	FUNCTION	PREHEAT	TEMPERATURE (°C)	DURATION (MIN.)	SHELF AND ACCESSORIES
Leavened cakes / Sponge cakes		Yes	170	30 - 50	2 
		Yes	160	30 - 50	2 
		Yes	160	30 - 50	4  1 
Filled cakes (cheesecake, strudel, apple pie)		Yes	160 - 200	30 - 85	3 
		Yes	160 - 200	35 - 90	4  1 
Cookies / Shortbread		Yes	150	20 - 40	3 
		Yes	140	30 - 50	4 
		Yes	140	30 - 50	4  1 
		Yes	135	40 - 60	5  3  1 
Small cakes / Muffin		Yes	170	20 - 40	3 
		Yes	150	30 - 50	4 
		Yes	150	30 - 50	4  1 
		Yes	150	40 - 60	5  3  1 
Choux buns		Yes	180 - 200	30 - 40	3 
		Yes	180 - 190	35 - 45	4  1 
		Yes	180 - 190	35 - 45 *	5  3  1 
Meringues		Yes	90	110 - 150	3 
		Yes	90	130 - 150	4  1 
		Yes	90	140 - 160 *	5  3  1 
Pizza / Bread / Focaccia		Yes	190 - 250	15 - 50	2 
		Yes	190 - 230	20 - 50	4  1 
Pizza (Thin, thick, focaccia)		Yes	220 - 240	25 - 50 *	5  3  1 
Frozen pizza		Yes	250	10 - 15	3 
		Yes	250	10 - 20	4  1 
		Yes	220 - 240	15 - 30	5  3  1 
Savoury pies (vegetable pie, quiche)		Yes	180 - 190	45 - 55	3 
		Yes	180 - 190	45 - 60	4  1 
		Yes	180 - 190	45 - 70 *	5  3  1 
Vols-au-vent / Puff pastry crackers		Yes	190 - 200	20 - 30	3 
		Yes	180 - 190	20 - 40	4  1 
		Yes	180 - 190	20 - 40 *	5  3  1 
Lasagna / Flans / Baked pasta / Cannelloni		Yes	190 - 200	45 - 65	3 
Lamb / Veal / Beef / Pork 1 kg		Yes	190 - 200	80 - 110	3 

## FUNCTIONS



Conventional



Forced air

Convection  
bake

Grill



TurboGrill



MaxiCooking



Cook 4



Eco Forced air



RECIPE	FUNCTION	PREHEAT	TEMPERATURE (°C)	DURATION (MIN.)	SHELF AND ACCESSORIES
Roast pork with crackling 2 kg		—	170	110 - 150	2
Chicken / Rabbit / Duck 1 kg		Yes	200 - 230	50 - 100	3
Turkey / Goose 3 kg		Yes	190 - 200	80 - 130	2
Baked fish / en papillote (fillets, whole)		Yes	180 - 200	40 - 60	3
Stuffed vegetables (tomatoes, courgettes, aubergines)		Yes	180 - 200	50 - 60	2
Toast		—	3 (High)	3 - 6	5
Fish fillets / Steaks		—	2 (Mid)	20 - 30 **	4 3
Sausages / Kebabs / Spare ribs / Hamburgers		—	2 - 3 (Mid - High)	15 - 30 **	5 4
Roast chicken 1-1.3 kg		—	2 (Mid)	55 - 70 ***	2 1
Leg of lamb / Shanks		—	2 (Mid)	60 - 90 ***	3
Roast potatoes		—	2 (Mid)	35 - 55 ***	3
Vegetable gratin		—	3 (High)	10 - 25	3
Cookies	 Cookies	Yes	135	50 - 70	5 4 3 1
Tarts	 Tarts	Yes	170	50 - 70	5 3 2 1
Round pizzas	 Pizza	Yes	210	40 - 60	5 3 2 1
Complete meal: Fruit tart (level 5) / lasagna (level 3) / meat (level 1)		Yes	190	40 - 120 *	5 3 1
Complete meal: Fruit tart (level 5) / roasted vegetables (level 4) / lasagna (level 2) / cuts of meat (level 1)	 Menu	Yes	190	40 - 120 *	5 4 2 1
Lasagna & Meat		Yes	200	50 - 100 *	4 1
Meat & Potatoes		Yes	200	45 - 100 *	4 1
Fish & Vegetables		Yes	180	30 - 50 *	4 1
Stuffed roasting joints		—	200	80 - 120 *	3
Cuts of meat (rabbit, chicken, lamb)		—	200	50 - 100 *	3

\* Estimated length of time: dishes can be removed from the oven at different times depending on personal preference.

\*\* Turn food halfway through cooking.

\*\*\* Turn food two thirds of the way through cooking (if necessary).

#### HOW TO READ THE COOKING TABLE

The table lists the best function, accessories and level to use to cook different types of food. Cooking times start from the moment food is placed in the oven, excluding preheating (where required). Cooking temperatures and times are approximate and depend on the amount of food and the type of accessory used. Use the lowest recommended settings to begin with and, if the food is not cooked enough, then switch to higher settings. Use the accessories supplied and preferably darkcoloured metal cake tins and baking trays. You can also use Pyrex or stoneware pans and accessories, but bear in mind that cooking times will be slightly longer.

#### ACCESSORIES

Wire shelf

Oven tray or cake tin on wire shelf

Drip tray / Baking tray or oven tray on wire shelf

Drip tray / Baking tray

Drip tray with 500 ml of water

Meat probe (if supplied)

## CLEANING AND MAINTENANCE

Make sure that the oven has cooled down before carrying out any maintenance or cleaning. Do not use steam cleaners.

Do not use wire wool, abrasive scourers or abrasive/corrosive cleaning agents, as these could damage the surfaces of the appliance.

Wear protective gloves. The oven must be disconnected from the mains before carrying out any kind of maintenance work.

### EXTERIOR SURFACES

- Clean the surfaces with a damp microfibre cloth. If they are very dirty, add a few drops of pH-neutral detergent. Finish off with a dry cloth.
- Do not use corrosive or abrasive detergents. If any of these products inadvertently comes into contact with the surfaces of the appliance, clean immediately with a damp microfibre cloth.

### INTERIOR SURFACES

- After every use, leave the oven to cool and then clean it, preferably while it is still warm, to remove any deposits or stains caused by food residues. To dry any condensation that has formed as a result of cooking foods with a high water content, let the oven to cool completely and then wipe it with a cloth or sponge.

- Clean the glass in the door with a suitable liquid detergent.
- The oven door can be removed to facilitate cleaning.

### ACCESSORIES

Soak the accessories in a washing-up liquid solution after use, handling them with oven gloves if they are still hot. Food residues can be removed using a washing-up brush or a sponge.

### REMOVING AND REFITTING THE DOOR

1. To remove the door, open it fully and lower the catches until they are in the unlock position.

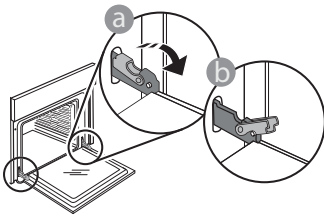

2. Close the door as much as you can. Take a firm hold of the door with both hands – do not hold it by the handle. Simply remove the door by continuing to close it while pulling it upwards at the same time until it is released from its seating. Put the door to one side, resting it on a soft surface.

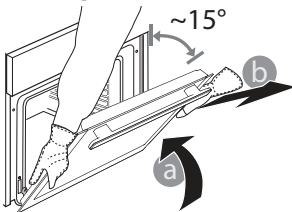

3. Refit the door by moving it towards the oven, aligning the hooks of the hinges with their seating and securing the upper part onto its seating.
4. Lower the door and then open it fully. Lower the catches into their original position: Make sure that you lower them down completely.

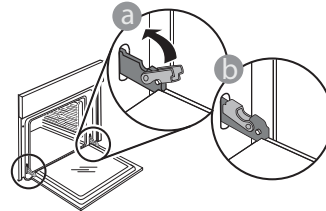

Apply gentle pressure to check that the catches are in the correct position.

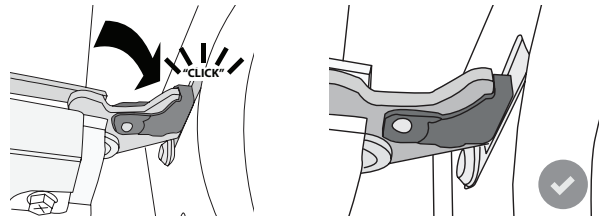

5. Try closing the door and check to make sure that it lines up with the control panel. If it does not, repeat the steps above: The door could become damaged if it does not work properly.

## REPLACING THE LAMP

1. Disconnect the oven from the power supply.
2. Unscrew the cover from the light, replace the bulb and screw the cover back on the light.
3. Reconnect the oven to the power supply.

Please note: Only use 20-40 W/230 ~ V type G9, T300°C halogen bulbs. The bulb used in the product is specifically designed for domestic appliances and is not suitable for general room lighting within the home (EC Regulation 244/2009). Light bulbs are available from our After-sales Service.

- If using halogen bulbs, do not handle them with your bare hands as your fingerprints could cause damage. Do not use the oven until the light cover has been refitted.

## TROUBLESHOOTING

PROBLEM	POSSIBLE CAUSE	SOLUTION
The oven is not working.	Power cut. Disconnection from the mains.	Check for the presence of mains electrical power and whether the oven is connected to the electricity supply. Turn off the oven and restart it to see if the fault persists.
The display shows the letter "F" followed by a number or letter.	Oven failure.	Turn off the oven and restart it to see if the problem persists. Try to perform the "FACTORY RESET" from, selectable from "SETTINGS". Contact you nearest Client After-sales Service Centre and state the number following the letter "F".
The oven does not heat up.	When "DEMO" is "On" all commands are active and menus available but the oven doesn't heat up. DEMO appears on display every 60 seconds.	Access "DEMO" from "SETTINGS" and select "Off".
The light switches off.	"ECO" mode is "On".	Access "ECO" from "SETTINGS" and select "Off".
The door will not open.	Cleaning cycle in progress.	Wait for the function to finish and for the oven to cool down.
The home power goes off.	Power setting wrong.	Verify if your domestic network has at least a rating of more than 3 kW. If no, decrease the power to 13 Ampere. Access "POWER" from "SETTINGS" and select "LOW".



You can download the Safety Instructions, User Manual, Product Fiche and Energy data by:

- Visiting our website [docs.whirlpool.eu](http://docs.whirlpool.eu)
- Using QR Code
- Alternatively, **contact our After-sales Service** (See phone number in the warranty booklet).  
When contacting our After-sales Service, please state the codes provided on your product's identification plate.

### For markets outside Europe:

To register your product and to receive more comprehensive local help and support, please call the number shown on the warranty booklet specific to your country or follow the website's instructions on:

Australia: [www.whirlpool.com.au](http://www.whirlpool.com.au)  
 Hong Kong: [www.whirlpool.com.hk](http://www.whirlpool.com.hk)  
 New Zealand: [www.whirlpool.co.nz](http://www.whirlpool.co.nz)  
 Singapore: [www.whirlpool.com.sg](http://www.whirlpool.com.sg)  
 South Korea: [www.whirlpool.co.kr](http://www.whirlpool.co.kr)  
 Taiwan: [www.whirlpool.com.tw](http://www.whirlpool.com.tw)  
 Vietnam: [www.whirlpool.com.vn](http://www.whirlpool.com.vn)

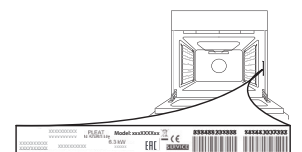



**MERCI D'AVOIR CHOISI UN PRODUIT WHIRLPOOL**

Afin de profiter d'une assistance complète, veuillez enregistrer votre appareil sur [www.whirlpool.eu/register](http://www.whirlpool.eu/register)

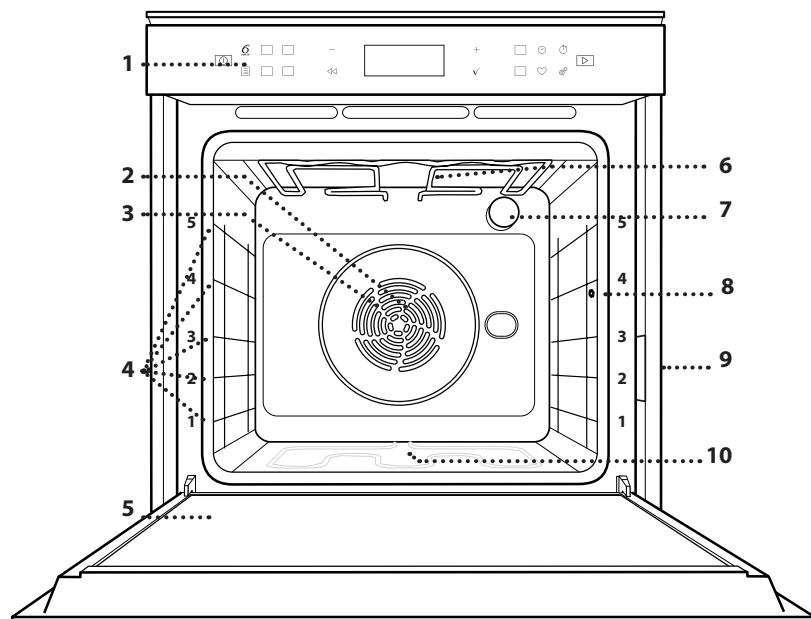

Lisez attentivement les consignes de sécurité avant d'utiliser l'appareil.

**DESCRIPTION DU PRODUIT**

1. Panneau de commande
2. Ventilateur
3. Élément chauffant rond (invisible)
4. Supports de grille (le niveau est indiqué à l'avant du four)
5. Porte
6. Élément chauffant supérieur/gril
7. Ampoule
8. Point d'insertion de la sonde à viande
9. Plaque signalétique (ne pas enlever)
10. Élément chauffant inférieur (invisible)

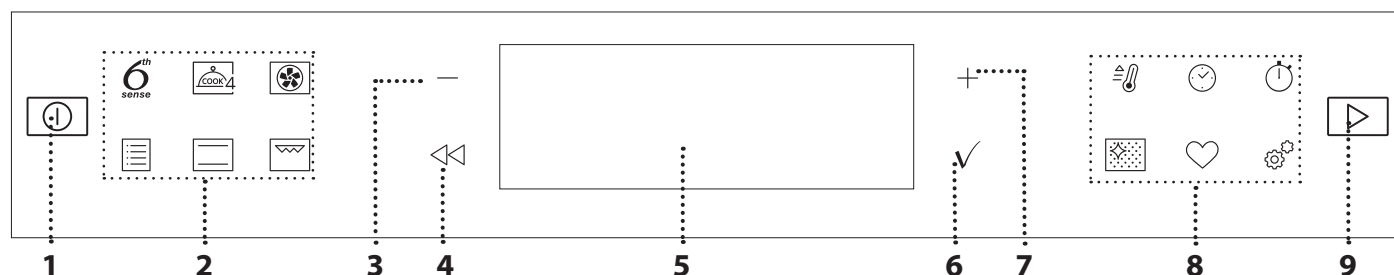
**DESCRIPTION DU BANDEAU DE COMMANDE**

**1. ON / OFF**

Pour allumer ou éteindre le four, et pour interrompre une fonction.

**2. ACCÈS DIRECT AUX FONCTIONS**

Pour accéder rapidement aux fonctions et au menu.

**3. BOUTON DE NAVIGATION MOINS**

Pour naviguer à travers un menu et diminuer les réglages ou valeurs d'une fonction.

**4. RETOUR**

Pour retourner au menu précédent.

Pendant la cuisson, permet de modifier les réglages.

**5. ÉCRAN**
**6. CONFIRMER**

Pour confirmer la sélection d'une fonction ou le choix d'une valeur.

**7. BOUTON DE NAVIGATION PLUS**

Pour naviguer à travers un menu et augmenter les réglages ou valeurs d'une fonction.

**8. ACCÈS DIRECT AUX OPTIONS / FONCTIONS**

Pour un accès rapide aux fonctions, à la durée, aux réglages et aux favoris.

**9. DÉPART**

Pour lancer une fonction en utilisant des réglages de base ou spécifique.

# ACCESSOIRES

## GRILLE MÉTALLIQUE

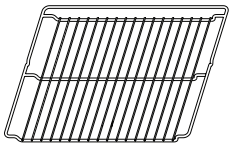

Utilisées pour la cuisson des aliments ou comme support pour les lèchefrites, moules à gâteau, et autres plats de cuisson résistants à la chaleur.

## LÈCHEFRITE

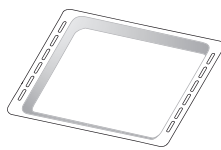

Utiliser comme plat de cuisson pour la viande, le poisson, les légumes, la focaccia, etc., ou pour recueillir les jus de cuisson en la plaçant sous la grille métallique.

## PLAQUE DE CUISSON

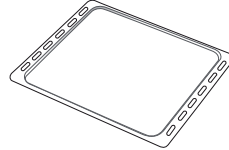

Pour la cuisson du pain et des pâtisseries, mais aussi pour cuire des rôtis, du poisson en papillotes, etc.

## GRILLES COULISSANTES\*

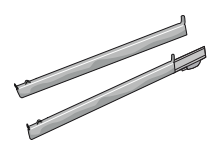

Pour insérer ou enlever les accessoires plus facilement.

## SONDE À VIANDE\*

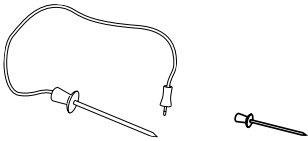

pour mesurer la température interne des aliments pendant la cuisson.

\* Disponible sur certains modèles seulement

Le nombre et type d'accessoires peuvent varier selon le modèle acheté.

Il est possible d'acheter séparément d'autres accessoires auprès du Service Après-Vente.

## INSÉRER LA GRILLE MÉTALLIQUE ET LES AUTRES ACCESSOIRES

Insérez la grille métallique horizontalement en la glissant sur les supports de grille, assurez-vous que le côté avec le bord relevé est placé vers le haut.

Les autres accessoires, comme la lèchefrite et la plaque de cuisson, sont insérés à l'horizontal, de la même manière que la grille métallique.

## ENLEVER ET REPLACER LES SUPPORTS DE GRILLE

- Pour enlever les supports de grille, soulevez les supports et sortez délicatement la partie inférieure de leur appui : Les supports de grille peuvent maintenant être enlevés.
- Pour replacer les supports de grille, vous devez en premier les replacer dans leur appui supérieur. En les maintenant soulevés, glissez-les dans le compartiment de cuisson, abaissez-les ensuite dans leur appui inférieur.

## INSTALLER LES GRILLES COULISSANTES

(SELON LE MODÈLE)

Enlevez les supports de grille du four et enlevez la protection de plastique des grilles coulissantes.

Attachez l'agrafe supérieure de la grille coulissante au support de grille et glissez-la aussi loin que possible. Abaissez l'autre agrafe en place.

Pour fixer le guide, pressez la partie inférieure de l'agrafe fermement sur le support de grille. Assurez-vous que les grilles peuvent se déplacer librement. Répétez ces étapes pour l'autre support de grille du même niveau.

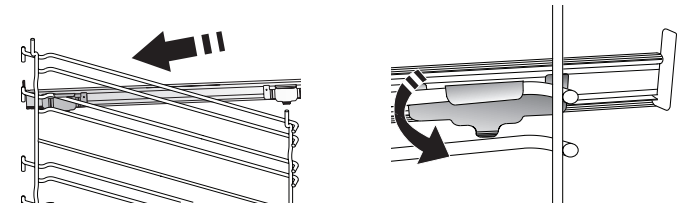

Veillez noter: Les grilles coulissantes peuvent être installées au niveau de votre choix.

## UTILISATION DE LA SONDE VIANDE (LE CAS ÉCHÉANT)



Insérez la sonde profondément dans la viande en évitant les os et les parties grasses. Pour la volaille, insérez la longueur de la sonde dans le centre de la poitrine en évitant les zones creuses.

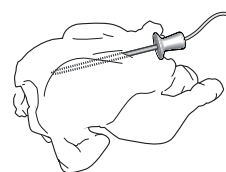

Placez les aliments dans le four et branchez la fiche dans la prise prévue à cet effet sur le côté droit du compartiment de cuisson du four.

## FONCTIONS



### 6<sup>th</sup> SENSE

Elles permettent une cuisson totalement automatique de tous les types d'aliments (Lasagnes, Viande, Poisson, Légumes, Gâteaux & Pâtisseries, Quiche/ Cake salé, Pain, Pizza). Pour obtenir le meilleur de cette fonction, suivez les indications sur la table de cuisson correspondante.



### COOK 4

Pour cuire différents aliments qui nécessitent la même température de cuisson sur quatre niveaux en même temps. Cette fonction peut être utilisée pour cuire des cookies, des gâteaux, des pizzas rondes (même congelées) et pour préparer un repas complet. Suivez le tableau de cuisson pour obtenir les meilleurs résultats.



### CHALEUR PULSÉE

Pour cuire différents aliments demandant la même température de cuisson sur plusieurs grilles (maximum de trois) en même temps. Cette fonction permet de cuire différents aliments sans transmettre les odeurs d'un aliment à l'autre.



### TRADITIONNELS

- **AIR BRASSÉ**  
Pour cuire de la viande, des gâteaux avec garnitures sur une grille uniquement.
- **TURBO GRILL**  
Pour griller de gros morceaux de viande (gigots, rôti de bœuf, poulet). Nous vous conseillons d'utiliser une lèchefrite pour recueillir les jus de cuisson : Placez la lèchefrite, contenant 500 ml d'eau, sur n'importe quel niveau sous la grille.
- **SURGELÉS**  
La fonction sélectionne automatiquement la température et le mode de cuisson appropriés pour 5 types de plats préparés surgelés différents. Il n'est pas nécessaire de préchauffer le four.
- **FONCTIONS SPÉCIALES**
  - » **GROSSES PIÈCES**  
La fonction sélectionne automatiquement le meilleur mode de cuisson et la température pour cuire de grosses pièces de viande (de plus de 2,5 kg). Il est conseillé de retourner la viande pendant la cuisson pour obtenir un dorage homogène des deux côtés. Arrosez de temps à autre la viande avec son jus de cuisson pour éviter son dessèchement.
  - » **LEVAGE DE PÂTE**  
Pour un levage parfait des pâtes sucrées ou salées. Pour assurer la qualité de levage, n'activez pas la fonction si le four est encore chaud après un cycle de cuisson.
  - » **DÉCONGÉLATION**  
Pour accélérer la décongélation des aliments. Placez les aliments sur la grille du milieu. Laissez la nourriture dans son emballage pour empêcher qu'elle se dessèche.

### » GARDER AU CHAUD

Pour conserver les aliments cuits chauds et croustillants.

### » ÉCO CHALEUR PULSÉE

Pour cuire les rôtis farcis et les filets de viande sur une seule grille. Les aliments ne s'assèchent pas trop grâce à une légère circulation d'air intermittente. Lorsque cette fonction ÉCO est utilisée, le voyant reste éteint pendant la cuisson. Pour utiliser le cycle ÉCO et ainsi optimiser la consommation d'énergie, la porte du four ne devrait pas être ouverte avant la fin de la cuisson.



### CONVECTION

Pour cuire tout type de plat sur une seule grille.



### GRILL

Pour cuire des biftecks, des brochettes, et des saucisses, faire gratiner des légumes et griller du pain. Pour la cuisson de la viande, nous vous conseillons d'utiliser une lèchefrite pour recueillir les jus de cuisson : Placez la lèchefrite, contenant 500 ml d'eau, sur n'importe quel niveau sous la grille.



### PRÉCHAUFFAGE RAPIDE

Pour préchauffer le four rapidement.



### MINUTERIES

Pour éditer les valeurs de temps de la fonction.



### MINUTEUR

Pour garder du temps sans activer de fonction.



### NETTOYAGE AUTOMATIQUE DU FOUR - PYRO

Pour éliminer les éclaboussures de la cuisson en utilisant un cycle à très haute température. Deux cycles de nettoyage automatique sont disponibles : Un cycle complet (Pyro) et un cycle plus court (Pyro Eco). Nous vous recommandons d'utiliser le cycle plus court à intervalles réguliers et le cycle complet seulement lorsque le four est très sale.



### FAVORI

Pour récupérer la liste de 10 fonctions favorites.



### RÉGLAGES

Pour ajuster les réglages du four.

Lorsque le mode "ÉCO" est actif, la luminosité de l'écran sera réduite pour économiser de l'énergie et la lampe s'éteint après 1 minute. Il sera réactivé automatiquement lorsque l'un quelconque des boutons est enfoncé.

Lorsque le mode "DÉMO" est activé, toutes les commandes sont actives et les menus disponibles mais le four ne chauffe pas. Pour désactiver ce mode, accédez à "DÉMO" à partir du menu « RÉGLAGES » et sélectionnez "Off".

En sélectionnant "REINITIALISER", le produit s'éteint et revient ensuite aux paramètres de son premier allumage. Tous les réglages seront effacés.



# PREMIÈRE UTILISATION

## 1. SÉLECTIONNER LA LANGUE

Vous devez régler la langue et l'heure lorsque vous allumez l'appareil pour la première fois : L'afficheur indiquera "English".

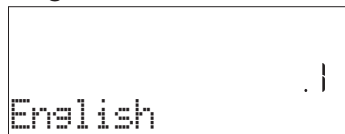

Appuyez sur + ou — pour faire défiler la liste de langues disponibles et sélectionnez celle que vous souhaitez. Appuyez sur ✓ pour confirmer votre sélection.

Veillez noter : La langue peut ensuite être changée en sélectionnant "LANGUE" dans le menu "RÉGLAGES", disponible en appuyant sur .

## 2. RÉGLER LA CONSOMMATION ÉNERGÉTIQUE

Le four est programmé pour consommer un niveau d'énergie électrique compatible avec un réseau domestique supérieur à 3 kW (16) : Si votre résidence utilise un niveau d'énergie plus bas, vous devez diminuer la valeur (13).

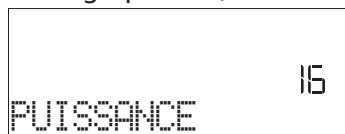

Appuyez sur + ou — sélectionnez 16 « Haut » ou 13 « Bas » et appuyez sur ✓ pour confirmer.

## 3. RÉGLER L'HEURE

Après avoir sélectionné l'alimentation, vous devez régler l'heure : Les deux chiffres indiquant l'heure clignotent à l'écran.



Appuyez sur + ou — pour régler l'heure et appuyez sur ✓ : Les deux chiffres indiquant les minutes clignotent à l'écran. Appuyez sur + ou — pour régler les minutes et appuyez sur ✓ pour confirmer.

Veillez noter : Vous pourriez avoir à régler l'heure à la suite d'une panne de courant prolongée. Sélectionnez "HORLOGE" dans le menu "RÉGLAGES", disponible en appuyant sur .

## 4. CHAUFFER LE FOUR

Un nouveau four peut dégager des odeurs provenant de la fabrication : ceci est parfaitement normal. Avant de cuire des aliments, nous vous conseillons de chauffer le four à vide pour éliminer les odeurs. Enlever les cartons de protection ou les pellicules transparentes du four, et enlever les accessoires qui se trouvent à l'intérieur. Chauffer le four à 200 °C pour environ une heure, de préférence utilisant une fonction avec circulation d'air (p. ex. « Chaleur pulsée » ou « Air Brassé »).

Veillez noter : Nous vous conseillons d'aérer la pièce après avoir utilisé l'appareil pour la première fois.

# UTILISATION QUOTIDIENNE

## 1. SÉLECTIONNER UNE FONCTION

Appuyez sur  pour allumer le four : l'écran affichera la dernière fonction principale utilisée ou le menu principal.

Les fonctions peuvent être sélectionnées en appuyant sur l'icône pour une des principales fonctions ou en faisant défiler un menu : Pour sélectionner un élément dans un menu (l'écran affichera le premier élément disponible), appuyez sur + ou — pour sélectionner l'élément souhaité, puis appuyez sur ✓ pour confirmer.

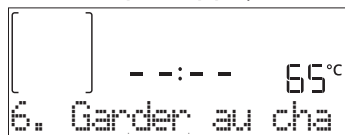

## 2. RÉGLER UNE FONCTION

Après avoir sélectionné la fonction désirée, vous pouvez changer les réglages. L'écran affiche en séquence les réglages qui peuvent être changés. En appuyant sur «», vous pouvez changer à nouveau les réglages précédents.

### TEMPÉRATURE / NIVEAU DU GRILL

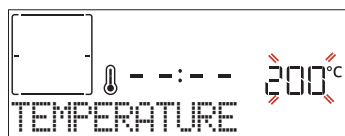



Lorsque la valeur clignote sur l'écran, appuyez sur + ou — pour la changer, puis appuyez sur ✓ pour confirmer et continuez avec les réglages qui suivent (si possible).

De la même façon, il est possible de régler le niveau de grill : Il existe trois niveaux de puissance prédéfinis pour le grill : 3 (élevé), 2 (moyen), 1 (bas).

Veillez noter : Une fois que la fonction a été activée, le niveau de la température/du grill peut être modifié en utilisant + ou —.

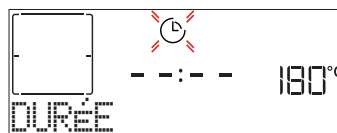
### DURÉE



Lorsque l'icône  clignote sur l'écran, appuyez sur + ou — pour régler le temps de cuisson que vous souhaitez puis appuyez sur ✓ pour confirmer. Vous ne devez pas régler le temps de cuisson si vous voulez gérer la cuisson manuellement (sans minuterie) : Appuyez sur ✓ ou  pour confirmer et démarrer la fonction. En sélectionnant ce mode, vous ne pouvez pas programmer un départ différé.

Veillez noter : Vous pouvez ajuster le temps de cuisson en cours de cuisson en appuyant sur  : appuyez sur + ou — pour le modifier, puis appuyez sur ✓ pour confirmer.



### HEURE DE FIN (DÉPART DIFFÉRÉ)

Pour plusieurs fonctions, une fois que vous avez réglé le temps de cuisson, vous pouvez retarder le démarrage de la fonction en programmant l'heure de fin de cuisson. L'écran affiche l'heure de fin tandis que l'icône  clignote.



Appuyez sur + ou - pour régler l'heure à laquelle vous souhaitez que la cuisson se termine, puis appuyez sur ✓ pour confirmer et activer la fonction. Placer les aliments dans le four et fermer la porte : La fonction démarre automatique après une période de temps déterminée pour que la cuisson se termine au moment désiré.

Veillez noter : La programmation d'un délai pour le début de la cuisson désactive la phase de préchauffage : Le four va atteindre la température désirée graduellement, ce qui signifie que les temps de cuisson vont être légèrement plus longs que ceux indiqués dans le tableau de cuisson. Pendant le temps d'attente, vous pouvez appuyer sur + ou - pour modifier l'heure de fin programmée ou appuyer sur << pour changer d'autres réglages. En appuyant sur ☺, afin de visualiser l'information, il est possible de passer de l'heure de fin à la durée et inversement.

### 6<sup>th</sup> SENSE

Ces fonctions sélectionnent automatiquement le meilleur mode de cuisson, la température et la durée de cuisson de tous les plats disponibles.

Lorsque cela est requis, indiquez simplement la caractéristique de l'aliment pour obtenir un résultat optimal.

#### POIDS / HAUTEUR (COUCHES À PLATEAU ROND)



Pour régler la fonction correctement, suivez les indications à l'écran, lorsque cela vous est demandé, et appuyez sur + ou - pour régler la valeur requise puis appuyez sur ✓ pour confirmer.

#### CUISSON DÉSIRÉE / BRUNISSAGE

Dans certaines fonctions 6<sup>th</sup> Sense, il est possible d'ajuster le niveau de cuisson.



Lorsque cela est demandé, appuyez sur + ou - pour sélectionner le niveau souhaité entre saignant (-1) et bien cuit (+1). Appuyez sur ✓ ou  pour confirmer et démarrer la fonction.

De la même façon, lorsque cela est autorisé, dans certaines fonctions 6<sup>th</sup> Sense, il est possible d'ajuster le niveau de brunissage entre bas (-1) et élevé (+1).

### 3. DÉMARRER LA FONCTION

À tout moment, si les valeurs par défaut sont celles souhaitées ou une fois que vous avez appliqué les réglages que vous demandez, appuyez sur  pour activer la

fonction.

Pendant la phase de retard, appuyez sur  pour ignorer cette phase et démarrer la fonction immédiatement.

Veillez noter : Une fois qu'une fonction a été sélectionnée, l'écran recommandera le niveau le plus adapté pour chacune d'elles. À tout moment, vous pouvez arrêter la fonction qui a été activée en appuyant sur .

Si le four est chaud et que la fonction nécessite une température maximale spécifique, un message apparaîtra sur l'écran. Appuyez sur << pour revenir à l'écran précédent et sélectionner une fonction différente ou attendez un refroidissement complet..

### 4. PRÉCHAUFFAGE

Certaines fonctions ont une phase de préchauffage : Une fois la fonction lancée, l'écran confirme que la phase de préchauffage est aussi activée.

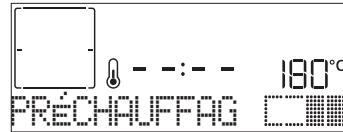

Une fois que cette phase est terminée, un signal sonore retentira et l'écran indiquera que le four a atteint la température réglée, nécessitant d'« AJOUTER ALIMENTS ». À ce moment, ouvrez la porte, placez les aliments dans le four, refermez la porte et commencez la cuisson en appuyant sur ✓ ou .

Veillez noter : Placer les aliments dans le four avant que le préchauffage soit terminé peut affecter la cuisson. La phase de préchauffage sera interrompue si vous ouvrez la porte durant le processus.

Le temps de cuisson ne comprend pas la phase de préchauffage. Vous pouvez toujours changer la température désirée en utilisant le bouton + ou - .

### 5. PAUSE DE CUISSON / RETOURNEMENT OU VÉRIFICATION DES ALIMENTS

En ouvrant la porte, la cuisson sera temporairement interrompue en désactivant les éléments chauffants.

Pour reprendre la cuisson, fermez la porte.

Dans certaines fonctions 6<sup>th</sup> Sense, il est nécessaire de retourner les aliments pendant la cuisson.

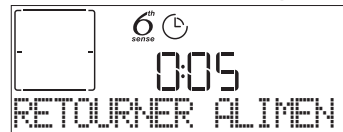

Un signal sonore retentira et l'écran affichera l'action à effectuer. Ouvrez la porte, effectuez l'action demandée par l'écran et fermez la porte, puis appuyez sur  pour poursuivre la cuisson.

De la même façon, à 10% du temps avant la fin de la cuisson, le four vous demande de vérifier les aliments.

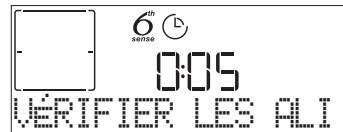



Un signal sonore retentira et l'écran affichera l'action à effectuer. Vérifiez les aliments, fermez la porte et appuyez sur  ou ✓ pour poursuivre la cuisson.

Veillez noter : Appuyez sur  pour sauter ces actions. Autrement, si aucune action n'est entreprise après un certain temps, le four poursuivra la cuisson.

## 6. FIN DE CUISSON

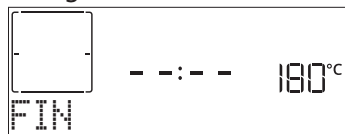
Un signal sonore et l'écran indiquent la fin de la cuisson.



Appuyez sur  pour poursuivre la cuisson en mode manuel (sans minuterie) ou appuyez sur  pour prolonger le temps de cuisson en réglant une nouvelle durée. Dans les deux cas, les paramètres de cuisson seront conservés.

## BRUNISSAGE

Certaines fonctions du four vous permettent de dorer la surface des aliments en allumant le gril une fois la cuisson terminée.

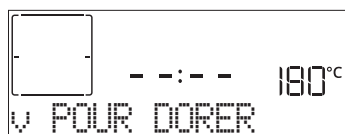





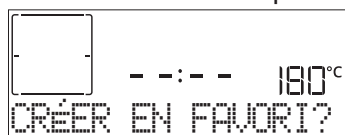

Lorsque l'écran montre le message pertinent, si nécessaire, appuyez sur  pour démarrer un cycle de brunissage de cinq minutes. Vous pouvez arrêter la fonction à tout moment en appuyant sur  pour éteindre le four.

## FAVORI

Une fois la cuisson terminée, l'écran vous demandera d'enregistrer la fonction avec un numéro entre 1 et 10 dans votre liste de fonctions préférées.







Si vous souhaitez enregistrer une fonction et mémoriser les paramètres actuels pour une utilisation ultérieure, appuyez sur  autrement, pour ignorer la demande, appuyez sur .

Une fois que vous avez appuyé sur , appuyez sur le  ou  pour sélectionner la position du numéro, puis appuyez sur  pour confirmer.

Veillez noter : Si la mémoire est pleine ou si le numéro choisi a déjà été pris, le four vous demandera de confirmer l'écrasement de la fonction précédente.

Pour accéder aux fonctions que vous avez sauvegardées, appuyez sur  : L'écran indiquera votre liste de fonctions préférées.



Appuyez sur  ou  pour sélectionner la fonction, confirmez en appuyant sur , puis appuyez sur  pour activer.





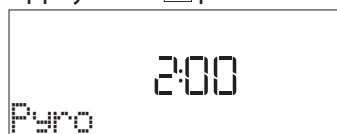

## NETTOYAGE AUTOMATIQUE - PYRO

**Ne touchez pas le four pendant le cycle de nettoyage Pyro. Éloignez les enfants et les animaux du four pendant et après (le temps que la pièce soit bien aérée) le cycle de nettoyage Pyro.**

Retirez tous les accessoires du four - incluant les supports de grille - avant d'activer la fonction. Si le four est installé sous une table de cuisson, assurez-vous que les brûleurs ou les plaques électriques sont éteints pendant le cycle d'auto-nettoyage. Pour des résultats de nettoyage optimaux, enlevez les résidus en excès à l'intérieur de la cavité et nettoyez la vitre de la porte intérieure avant d'utiliser la fonction Pyrolyse. Nous vous conseillons d'utiliser la fonction Nettoyage Pyro seulement si le four est très sale ou s'il dégage de mauvaises odeurs lors de la cuisson.



Appuyez sur  pour afficher « Pyro » sur l'écran.





Appuyez sur  ou  pour sélectionner le cycle souhaité, puis appuyez sur  pour confirmer. Une fois qu'un cycle a été sélectionné, si vous le souhaitez, appuyez sur  ou  pour régler l'heure de fin (départ différé), puis appuyez sur  pour confirmer.

Nettoyez la porte et enlevez tous les accessoires comme demandé, puis fermez la porte et appuyez sur  : le four commence un cycle d'auto-nettoyage et la porte se verrouille automatiquement : un message d'avertissement et le compte à rebours apparaissent à l'écran, indiquant le progrès du cycle. Une fois le cycle terminé, la porte reste verrouillée jusqu'à ce que la température à l'intérieur du four atteigne un niveau sécuritaire.



## MINUTEUR

Lorsque le four est éteint, l'écran peut être utilisé comme minuterie. Pour activer cette fonction, assurez-vous que le four est éteint et appuyez sur  ou  : L'icône  clignotera sur l'écran.

Appuyez sur  ou  pour régler la durée que vous souhaitez puis appuyez sur  pour activer la minuterie.





Un signal sonore retentit et l'écran s'allumera une fois que la minuterie a terminé le compte à rebours.

Veillez noter : Le minuteur n'active aucun de cycles de cuisson. Appuyez sur  ou  pour changer l'heure réglée sur la minuterie.

Une fois que la minuterie a été activée, vous pouvez également sélectionner et activer une fonction.

Appuyez sur  pour allumer le four, puis sélectionner la fonction que vous souhaitez.

Une fois que la fonction est activée, la minuterie continue son compte à rebours sans interférence avec la fonction.

Veillez noter : Pendant cette phase, il n'est pas possible de voir la minuterie (seule l'icône  sera affichée), qui continuera de décompter en arrière-plan. Pour récupérer l'écran de la minuterie, appuyez sur  pour arrêter la fonction actuellement active.

## VERROUILLAGE

Pour verrouiller le clavier, appuyez sur << et maintenez-le enfoncé pendant au moins cinq secondes. Répétez pour déverrouiller le clavier.



Veillez noter: Il est également possible d'activer cette fonction pendant la cuisson. Pour des raisons de sécurité, la fonction peut être éteinte en tout temps en appuyant sur [⏏].

## UTILISATION DE LA SONDE À VIANDE (LE CAS ÉCHÉANT)

L'utilisation de la sonde à viande vous permet de mesurer la température interne des aliments lors de la cuisson afin de vous assurer qu'ils atteignent la température optimale. La température du four varie selon la fonction que vous avez sélectionnée, mais la cuisson est toujours programmée pour se terminer une fois que la température spécifiée a été atteinte. Une fois que vous avez inséré la sonde, un signal sonore est activé et le message « Sonde branchée » apparaît à l'écran.



Sélectionnez la fonction dont vous avez besoin parmi celles qui sont compatibles (fonctions Convection naturelle, Chaleur pulsée, Air brassé, Turbo Grill, Éco chaleur pulsée, Grosses pièces, 6<sup>th</sup> Sense) : L'écran demande à régler la température cible de la sonde : Appuyez sur + ou - pour la régler et appuyez sur ✓ pour régler les paramètres de cuisson suivants.

Alors que la cuisson est programmée pour se terminer une fois que la température requise a été atteinte, il n'est pas possible de régler le temps de cuisson ou de régler une heure de fin de cuisson spécifique. La lumière restera allumée jusqu'à ce que la sonde soit enlevée.

Si la sonde est enlevée pendant la cuisson, elle continuera en mode traditionnel (sans temps).

Un signal sonore retentira et l'écran indiquera quand la sonde a atteint la température requise.

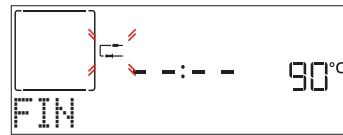















































Veillez noter: Pour modifier les réglages par la suite, appuyez sur + ou - pour la température de la sonde ou appuyez sur << pour d'autres réglages. Un signal sonore et un message vous diront si l'utilisation de la sonde n'est pas compatible avec l'action effectuée. Si tel est le cas, enlevez la sonde.

6<sup>th</sup>  
sense







## TABLEAU DE CUISSON

CATÉGORIES D'ALIMENTS		QUANTITÉ	RETOURNEMENT (DU TEMPS DE CUISSON)	NIVEAU ET ACCESSOIRES
LASAGNES	-	0,5 - 3 kg	-	2
VIANDES	Rôti de boeuf	Rôti (cuisson 0)	0,6 - 2 kg **	3
		Hamburgers (cuisson 0)	1,5 - 3 cm	3/5
		Rôtir-Cuisson basse température (cuisson désirée 0) *	0,6 - 2 kg **	3
	Rôti de porc	Rôti	0,6 - 2,5 kg **	3
		Jarret *	0,5 - 2,0 kg **	3
		Saucisses	1,5 - 4 cm	2/3
	Rôti de veau *	0,6 - 2,5 kg **	3	
	Rôti d'agneau	Rôti (cuisson désirée 0) *	0,6 - 2,5 kg **	2
		Gigot d'agneau (cuisson désirée 0) *	0,5 - 2,0 kg **	2
	Poulet rôti	Entier	0,6 - 3 kg **	2
		Entier à l'étouffée *	0,6 - 3 kg **	2
		Filet & poitrine	1 - 5 cm	2/3
Dinde entière rôtie	Entière *	0,6 - 3 kg **	2	
	Entier à l'étouffée *	0,6 - 3 kg **	2	
Brochettes	1 grille	1/2	5	





























































































CATÉGORIES D'ALIMENTS		QUANTITÉ	RETOURNEMENT (DU TEMPS DE CUISSON)	NIVEAU ET ACCESSOIRES	
POISSON	Filets	0,5 - 3 cm	-	 	
	Filets surgelés	0,5 - 3 cm	-	 	
LÉGUMES	Légumes rôtis	Pommes de terre	0,5 - 1,5 kg	-	
		Légumes étouffés	0,1 - 0,5 kg chacun	-	
		Légumes rôtis	0,5 - 1,5 kg	-	
	Légumes en gratin	Pommes de terre	1 plateau	-	 
		Tomates	1 plateau	-	 
		Poivrons	1 plateau	-	 
		Brocolis	1 plateau	-	 
		Chou-fleur	1 plateau	-	 
Autres	1 plateau	-	 		
GÂTEAUX & PÂTISSERIES	Gâteaux au levain en moule	Génoise	0,5 - 1,2 kg	-	 
	Gâteaux & tartes garnies	Biscuits	0,2 - 0,6 kg	-	
		Pâte à choux	1 plateau	-	
		Tarte	0,4 - 1,6 kg	-	 
		Strudel	0,4 - 1,6 kg	-	
		Tarte aux fruits	0,5 - 2 kg	-	 
QUICHE & TARTE	-	0,8 - 1,2 kg	-	 	
PAIN	Petit pain	60 - 150 g chacun	-		
	Pain carré	400 - 600 g chacun	-	 	
	Gros pain	0,5 - 2,0 kg	-		
	Baguettes	200 - 300 g chacune	-		
PIZZA	Fine	ronde - plateau	-		
	Épaisse	ronde - plateau	-		
	Surgelés				
			1 - 4 couches	-	        

\* Uniquement sur certains modèles. Fonction disponible uniquement en combinaison avec la sonde à viande.

\*\* Quantité suggérée.

ACCESSOIRES						
	Grille métallique	Plaque de cuisson ou moule à gâteau sur la grille métallique	Lèche-frite / plaque de cuisson ou plat de cuisson sur la grille métallique	Lèche-frite / Plaque de cuisson	Lèche-frite contenant 500 ml d'eau	Sonde à viande (si elle est fournie)

# TABLEAU DE CUISSON

RECETTE	FONCTION	PRÉCHAUFFAGE	TEMPÉRATURE (°C)	DURÉE (MIN)	GRILLE ET ACCESSOIRES
Gâteaux à pâte levée / Génoise		Oui	170	30 - 50	2 
		Oui	160	30 - 50	2 
		Oui	160	30 - 50	4  1 
Gâteaux fourrés (gâteau au fromage, strudel, tarte aux pommes)		Oui	160 - 200	30 - 85	3 
		Oui	160 - 200	35 - 90	4  1 
Biscuits / Petit pain		Oui	150	20 - 40	3 
		Oui	140	30 - 50	4 
		Oui	140	30 - 50	4  1 
		Oui	135	40 - 60	5  3  1 
Petits gâteaux / Muffins		Oui	170	20 - 40	3 
		Oui	150	30 - 50	4 
		Oui	150	30 - 50	4  1 
		Oui	150	40 - 60	5  3  1 
Chouquettes		Oui	180 - 200	30 - 40	3 
		Oui	180 - 190	35 - 45	4  1 
		Oui	180 - 190	35 - 45 *	5  3  1 
Meringues		Oui	90	110 - 150	3 
		Oui	90	130 - 150	4  1 
		Oui	90	140 - 160 *	5  3  1 
Pizza / Pain / Fougasse		Oui	190 - 250	15 - 50	2 
		Oui	190 - 230	20 - 50	4  1 
Pizza (Mince, épaisse, focaccia)		Oui	220 - 240	25 - 50 *	5  3  1 
Pizza surgelée		Oui	250	10 - 15	3 
		Oui	250	10 - 20	4  1 
		Oui	220 - 240	15 - 30	5  3  1 
Tourtes (Tourtes aux légumes, quiches)		Oui	180 - 190	45 - 55	3 
		Oui	180 - 190	45 - 60	4  1 
		Oui	180 - 190	45 - 70 *	5  3  1 
Vol-au-vent / Feuilletés		Oui	190 - 200	20 - 30	3 
		Oui	180 - 190	20 - 40	4  1 
		Oui	180 - 190	20 - 40 *	5  3  1 
Lasagnes / Gratins / Pâtes au four / Cannelloni		Oui	190 - 200	45 - 65	3 
Agneau / Veau / Bœuf / Porc 1 kg		Oui	190 - 200	80 - 110	3 

FONCTIONS



Convection



Chaleur pulsée



Air Brassé



Grill



Turbo Grill



































































Grosses Pièces



Cook 4

Éco Chaleur  
Pulsée



RECETTE	FONCTION	PRÉCHAUFFAGE	TEMPÉRATURE (°C)	DURÉE (MIN)	GRILLE ET ACCESSOIRES
Rôti de porc avec grattons 2 kg		-	170	110 - 150	
Poulet/lapin/canard 1 kg		Oui	200 - 230	50 - 100	
Dinde / Oie 3 kg		Oui	190 - 200	80 - 130	
Poisson au four / en papillote (filet, entier)		Oui	180 - 200	40 - 60	
Légumes farcis (tomates, courgettes, aubergines)		Oui	180 - 200	50 - 60	
Rôtie		-	3 (Élevée)	3 - 6	
Filet de poisson / Entrecôtes		-	2 (Moy)	20 - 30 **	 
Saucisses / brochettes / côtes levées / hamburgers		-	2 - 3 (Moy - Haute)	15 - 30 **	 
Poulet rôti 1-1,3 kg		-	2 (Moy)	55 - 70 ***	 
Cuisse d'agneau / Jarrets		-	2 (Moy)	60 - 90 ***	
Pommes de terre rôties		-	2 (Moy)	35 - 55 ***	
Légumes gratinés		-	3 (Élevée)	10 - 25	
Biscuits	 Biscuits	Oui	135	50 - 70	   
Tartes	 Tartes	Oui	170	50 - 70	   
Pizzas ronde	 Pizza	Oui	210	40 - 60	   
Repas complet : Tarte aux fruits (niveau 5) / lasagnes (niveau 3) / viande (niveau 1)		Oui	190	40 - 120 *	  
Repas complet : Tarte aux fruits (niveau 5) / légumes grillés (niveau 4) / lasagnes (niveau 2) / découpes de viande (niveau 1)	 Menu	Oui	190	40 - 120 *	   
Lasagnes & Viandes		Oui	200	50 - 100 *	 
Viandes & pommes de terre		Oui	200	45 - 100 *	 
Poisson & légumes		Oui	180	30 - 50 *	 
Rôtis farcis		-	200	80 - 120 *	
Coupes de viande (lapin, poulet, agneau)		-	200	50 - 100 *	

\* Durée approximative : les plats peuvent être retirés du four en tout temps, selon vos préférences personnelles.

\*\* Tourner les aliments à mi-cuisson.

\*\*\* Au besoin, retournez les aliments aux deux tiers de la cuisson.

#### COMMENT LIRE LE TABLEAU DE CUISSON

Le tableau indique la meilleure fonction, les accessoires, et le niveau à utiliser pour la cuisson des différents types d'aliments. Les temps de cuisson commencent au moment de l'introduction du plat dans le four et ne tiennent pas compte du préchauffage (s'il est nécessaire). Les températures et temps de cuisson sont approximatifs et dépendent de la quantité d'aliments et du type d'accessoire. Pour commencer, utilisez les valeurs conseillées les plus basses, et si les aliments ne sont pas assez cuits, augmentez-les. Utilisez les accessoires fournis, et de préférence des moules à gâteau et des plats de cuisson en métal foncé. Vous pouvez aussi utiliser des plaques et accessoires en pyrex ou en céramique ; cependant, les temps de cuisson seront sensiblement plus longs.

ACCESSOIRES

  
Grille métallique

  
Plaque de cuisson ou moule à gâteau sur la grille métallique

  
Lèche-frite / plaque de cuisson sur la grille métallique

  
Lèche-frite / Plaque de cuisson

  
Lèche-frite contenant 500 ml d'eau

  
Sonde à viande (si elle est fournie)

## NETTOYAGE ET ENTRETIEN

Assurez-vous que le four ait refroidi avant tout entretien ou nettoyage.

N'utilisez pas de nettoyeur à vapeur.

N'utilisez pas de laine d'acier, de tampons à récurer abrasifs, ou des détergents abrasifs ou corrosifs, ils pourraient endommager les surfaces de l'appareil.

Utilisez des gants de protection. L'appareil doit être débranché de l'alimentation principale avant d'effectuer des travaux d'entretien.

### SURFACES EXTÉRIEURES

- Nettoyez les surfaces à l'aide d'un chiffon en microfibre humide. Si elles sont très sales, ajoutez quelques gouttes de détergent à pH neutre. Essuyez avec un chiffon sec.
- N'utilisez pas de détergents corrosifs ou abrasifs. Si l'un de ces produits entre en contact avec des surfaces de l'appareil, nettoyez immédiatement à l'aide d'un chiffon en microfibre humide.

### SURFACES INTÉRIEURES

- Après chaque utilisation, laissez le four refroidir et nettoyez-le, de préférence lorsqu'il est encore tiède, pour enlever les dépôts ou taches laissés par les résidus de nourriture. Pour enlever la condensation qui se serait formée lors de la cuisson d'aliments avec une forte teneur en eau, laissez le four refroidir complètement et essuyez-le avec un chiffon ou une éponge.

- Nettoyez le verre dans la porte avec un détergent liquide approprié.
- La porte du four peut être enlevée pour faciliter le nettoyage.

### ACCESSOIRES

Faire tremper les accessoires dans de l'eau contenant un détergent à vaisselle après les avoir utilisés ; utilisez des gants de cuisine s'ils sont encore chauds. Utilisez une brosse à vaisselle ou une éponge pour enlever les résidus d'aliments.

### ENLEVER ET RÉINSTALLER LA PORTE

1. **Pour enlever la porte**, ouvrez-la complètement et abaissez les loquets jusqu'à qu'ils soient déverrouillés.

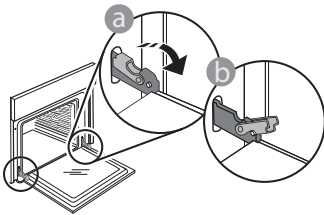

2. Fermez le plus possible la porte. Tenez la porte fermement avec les deux mains – ne la tenez pas par la poignée. Enlevez simplement la porte en continuant à la fermer tout en la tirant vers le haut jusqu'à ce qu'elle soit dégagée de ses appuis. Placez la porte de côté, l'appuyant sur une surface souple.

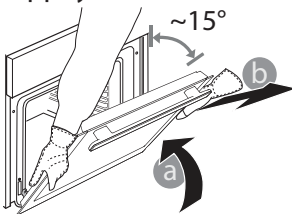

3. **Réinstallez la porte** en la plaçant devant le four pour aligner les crochets des charnières avec leurs appuis et attacher la partie supérieure sur son appui.
4. Abaissez la porte pour ensuite l'ouvrir complètement. Abaissez les loquets dans leur position originale : Assurez-vous de les abaisser complètement.

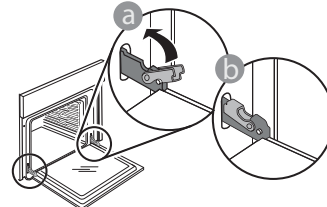

Appliquez une légère pression pour vous assurer que les loquets sont bien placés.

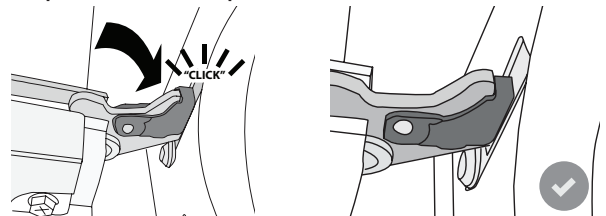

5. Essayez de fermer la porte et assurez-vous qu'elle est alignée avec le panneau de commande. Sinon, répétez les étapes précédentes : La porte pourrait s'endommager si elle ne fonctionne pas correctement.



## REPLACEMENT DE L'AMPOULE

1. Débranchez le four.
2. Dévissez le couvercle de l'ampoule, remplacez l'ampoule, et revissez le couvercle.
3. Rebranchez le four à l'alimentation électrique.

Veillez noter : Utilisez uniquement des ampoules à halogène de 20-40 W/230 ~ type V G9, T300°C. L'ampoule utilisée dans l'appareil est spécialement conçue pour les appareils électroménagers et ne convient pas pour l'éclairage d'une pièce de la maison (Règlement CE 244/2009). Ces ampoules sont disponibles auprès de notre Service Après-vente.

- Ne manipulez pas les ampoules à halogène à mains nues, les traces laissées par vos empreintes pourraient les endommager. Avant d'utiliser le four, assurez-vous que le couvercle de l'ampoule a bien été remis en place.

## GUIDE DE DÉPANNAGE

PROBLÈME	CAUSES POSSIBLES	SOLUTION
Le four ne fonctionne pas.	Coupure de courant. Débranchez de l'alimentation principale.	Assurez-vous qu'il n'y a pas de panne de courant et que le four est bien branché. Éteignez puis rallumez le four pour voir si le problème persiste.
L'écran affiche la lettre « F » suivi d'un numéro ou d'une lettre.	Défaillance du four.	Éteignez puis rallumez le four pour voir si le problème persiste. Essayez d'effectuer la « REINITIALISER » à partir de « RÉGLAGES ». Prenez en note le numéro qui suit la lettre « F » et contactez le Service Après-vente le plus près.
Le four ne chauffe pas.	Lorsque le mode "DÉMO" est activé, toutes les commandes sont actives et les menus disponibles mais le four ne chauffe pas. DÉMO apparaît sur l'écran toutes les 60 secondes.	Accédez au mode « DÉMO » à partir des « RÉGLAGES » et sélectionnez « Off ».
L'ampoule s'éteint.	Le mode « ÉCO » s'active.	Accédez au mode « ÉCO » à partir des « RÉGLAGES » et sélectionnez « Off ».
La porte ne s'ouvre pas.	Cycle de nettoyage en cours.	Attendez la fin de la fonction et laissez le four refroidir.
L'alimentation est coupée.	Niveau de puissance erroné.	Vérifiez sur votre réseau domestique a au moins une valeur de plus de 3 kW. Dans le cas contraire, diminuez la puissance à 13 Ampères. Accédez à « PUISSANCE » à partir de « RÉGLAGES » et sélectionnez « BAS ».



**Vous pouvez télécharger les consignes de sécurité, le manuel de l'utilisateur, la fiche produit et les données énergétiques :**

- En visitant notre site Internet [docs.whirlpool.eu](http://docs.whirlpool.eu)
- En utilisant le code QR
- Vous pouvez également **contacter notre service après-vente** (voir numéro de téléphone dans le livret de garantie). Lorsque vous contactez notre Service après-vente, veuillez indiquer les codes figurant sur la plaque signalétique de l'appareil.

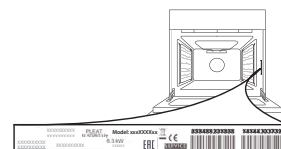



**GRAZIE PER AVERE ACQUISTATO UN PRODOTTO WHIRLPOOL**

Per ricevere un'assistenza più completa, registrare il prodotto su [www.whirlpool.eu/register](http://www.whirlpool.eu/register)

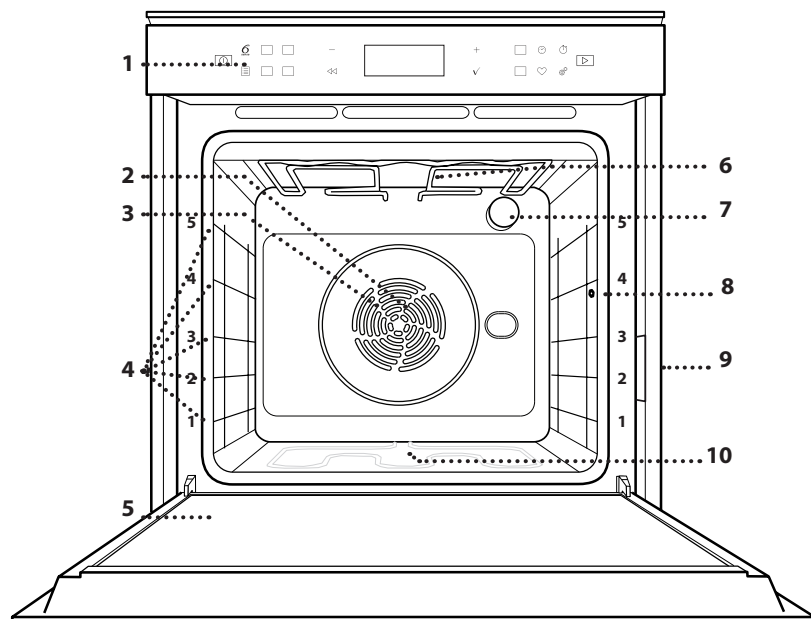

**Prima di utilizzare l'apparecchio, leggere attentamente le istruzioni relative alla sicurezza.**

## DESCRIZIONE PRODOTTO



1. Pannello comandi
2. Ventola
3. Resistenza circolare (non visibile)
4. Griglie laterali (il livello è indicato sulla parte frontale del forno)
5. Porta
6. Resistenza superiore / grill
7. Luce
8. Punto di inserimento della sonda carne
9. Targhetta matricola (da non rimuovere)
10. Resistenza inferiore (non visibile)

## DESCRIZIONE DEL PANNELLO COMANDI

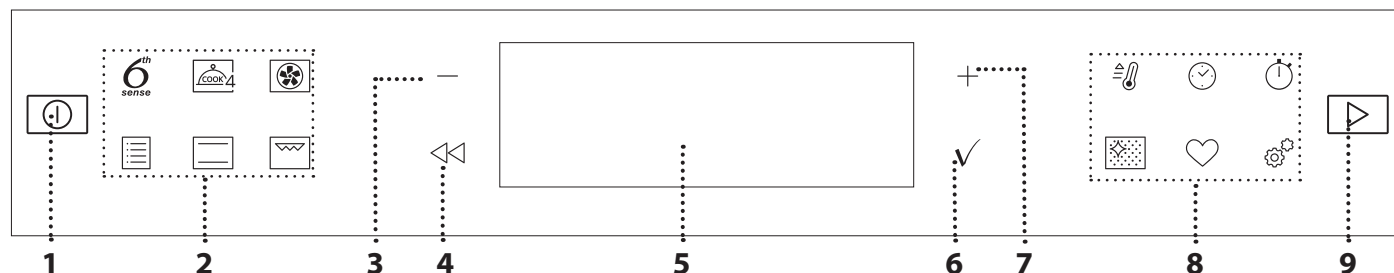
**1. ON / OFF**

Per accendere e spegnere il forno o arrestare un funzione attiva.

**2. TASTI DI ACCESSO DIRETTO ALLE FUNZIONI**

Per accedere rapidamente alle funzioni e al menu.

**3. TASTO DI NAVIGAZIONE MENO**

Per scorrere i menu e ridurre le impostazioni o i valori delle funzioni.

**4. INDIETRO**

Per tornare alla schermata precedente.

Durante la cottura, permette di modificare le impostazioni.

**5. DISPLAY**
**6. CONFERMA**

Per confermare la selezione di una funzione o un valore impostato.

**7. TASTO DI NAVIGAZIONE PIÙ**

Per scorrere i menu e aumentare le impostazioni o i valori delle funzioni.

**8. TASTI DI ACCESSO DIRETTO A OPZIONI E FUNZIONI**

Per impostare rapidamente le funzioni, la durata, le impostazioni e i preferiti.

**9. AVVIO**

Per avviare una funzione utilizzando i valori impostati o di base.

# ACCESSORI

## GRIGLIA

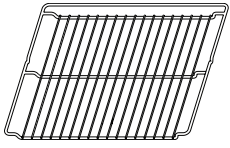

Da usare per la cottura degli alimenti o come supporto per pentole, tortiere e altri utensili da cucina.

## LECCARDA

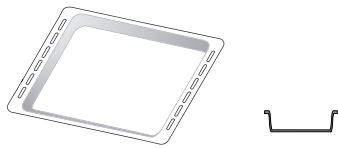

Da posizionare sotto la griglia per raccogliere i succhi di cottura o come piastra per cuocere carni, pesci, verdure, focacce, ecc.

## TEGLIA

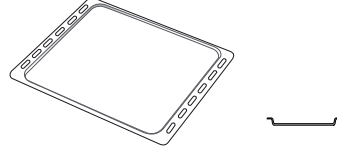

Da usare per cuocere prodotti di panetteria e pasticceria, ma anche carne arrosto, pesce al cartoccio, ecc.

## GUIDE SCORREVOLI\*

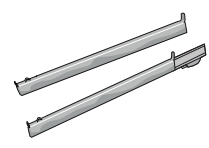

Per facilitare l'inserimento o la rimozione degli accessori.

## SONDA CARNE\*

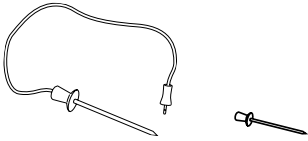

Per misurare la temperatura interna degli alimenti durante la cottura.

\* Disponibile solo su alcuni modelli

Il numero e il tipo di accessori possono variare a seconda del modello acquistato.

È possibile acquistare separatamente altri accessori presso il Servizio Assistenza.

## INSERIRE LA GRIGLIA E ALTRI ACCESSORI

Inserire la griglia orizzontalmente facendola scivolare sulle griglie laterali inserendo dapprima il lato rialzato orientato verso l'alto.

Gli altri accessori, come la leccarda o la teglia, si inseriscono orizzontalmente come la griglia.

## TOGLIERE E RIMONTARE LE GRIGLIE LATERALI

- Per togliere le griglie, sollevarle e sganciare la parte inferiore dalla sede tirandola leggermente: a questo punto è possibile rimuovere le griglie.
- Per rimontare le griglie, inserirle dapprima nelle sedi superiori. Avvicinarle alla cavità tenendo sollevato, quindi abbassarle in posizione nelle sedi inferiori.

## MONTARE LE GUIDE SCORREVOLI (SE PRESENTI)

Togliere dal forno le griglie laterali e rimuovere la protezione in plastica dalle guide scorrevoli.

Ancorare alla griglia laterale la clip superiore della guida e farla scivolare fino a fine corsa; abbassare in posizione l'altra clip.

Per fissare la guida, premere la parte inferiore della clip contro la griglia laterale. Assicurarsi che le guide possano scorrere liberamente. Ripetere questa operazione sull'altra griglia laterale, allo stesso livello.

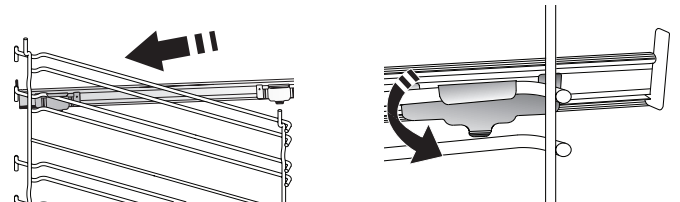

Nota: le guide scorrevoli possono essere montate a qualsiasi livello.

## USO DELLA SONDA CARNE (SE PRESENTE)

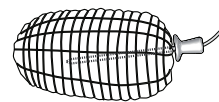

Introdurre la sonda nella carne evitando le ossa e le parti grasse. Per il pollame, la sonda deve essere inserita lateralmente, in mezzo al petto, avendo cura di evitare le parti cave.

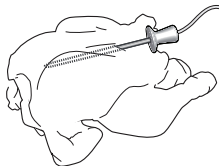

Introdurre gli alimenti nel forno e collegare lo spinotto inserendolo nell'apposita presa posizionata sul lato destro della cavità del forno.

## FUNZIONI



### 6<sup>th</sup> SENSE

Questa funzione permette la cottura completamente automatica di tutte le pietanze (lasagna, carne, pesce, verdure, torte & dolci, torte salate, pane, pizza).

Per utilizzare al meglio questa funzione si raccomanda di seguire le indicazioni della tabella di cottura.



### COOK 4

Per cuocere contemporaneamente su quattro ripiani alimenti diversi che richiedono la medesima temperatura di cottura. Questa funzione può essere utilizzata per cuocere biscotti, torte, pizze (anche surgelate) e per preparare un pasto completo. Per ottenere risultati ottimali si raccomanda di seguire la tabella di cottura.



### TERMOVENTILATO

Per cuocere contemporaneamente su più ripiani (massimo tre) alimenti diversi che richiedono la medesima temperatura di cottura. Questa funzione permette di eseguire la cottura senza trasmissione di odori da un alimento all'altro.



### TRADIZIONALI

#### • VENTILATO

Per cuocere carni o torte ripiene su un solo ripiano.

#### • TURBO GRILL

Per arrostitire grossi tagli di carne (cosciotti, roast beef, polli). Si consiglia di utilizzare una leccarda per raccogliere i liquidi di cottura: posizionarla un livello sotto la griglia e aggiungere 500 ml di acqua potabile.

#### • CIBI SURGELATI

Questa funzione seleziona automaticamente la temperatura e la modalità di cottura ottimali per 5 diverse categorie di alimenti pronti surgelati. Non è necessario preriscaldare il forno.

#### • FUNZIONI SPECIALI

##### » MAXI COOKING

Questa funzione seleziona automaticamente la migliore temperatura e modalità di cottura per tagli di carne di grandi dimensioni (oltre 2,5 kg). Si suggerisce di girare la carne durante la cottura per ottenere una doratura omogenea su entrambi i lati. È preferibile irrorarla di tanto in tanto con il fondo di cottura per evitare che si asciughi eccessivamente.

##### » LIEVITAZIONE

Per ottenere una lievitazione ottimale di impasti dolci o salati. Per preservare la qualità della lievitazione, non attivare la funzione se il forno è ancora caldo dopo un ciclo di cottura.

##### » SCONGELAMENTO

Per velocizzare lo scongelamento degli alimenti. Disporre gli alimenti sul ripiano intermedio.

Si suggerisce di lasciare l'alimento nella sua confezione per impedire che si asciughi eccessivamente all'esterno.

##### » TIENI IN CALDO

Per mantenere caldi e croccanti cibi appena cotti.

##### » ECO TERMOVENTILATO

Per cuocere arrostiti ripieni e filetti di carne su uno stesso ripiano. La circolazione intermittente dell'aria impedisce un'eccessiva asciugatura degli alimenti. In questa funzione ECO la luce rimane spenta durante la cottura. Per utilizzare il ciclo ECO e ottimizzare quindi i consumi energetici, la porta forno non deve essere aperta fino a completamento della cottura del cibo.



### STATICO

Per cuocere qualsiasi tipo di pietanza su un solo ripiano.



### GRILL

Per grigliare costate, spiedini e salsicce, gratinare verdure o dorare il pane. Per la grigliatura delle carni, si consiglia di utilizzare una leccarda per raccogliere il liquido di cottura: posizionarla un livello sotto la griglia e aggiungere 500 ml di acqua potabile.



### PRERISCALDAMENTO RAPIDO

Per riscaldare rapidamente il forno.



### TIMER

Per modificare i tempi di cottura delle funzioni.



### CONTA MINUTI

Per impostare il timer senza attivare una funzione.



### PULIZIA AUTOMATICA PER PIROLISI

Permette di eliminare i residui di cottura tramite un ciclo ad altissima temperatura. È possibile selezionare due cicli di autopulizia: un ciclo completo (Pirolisi) e un ciclo più breve (Pirolisi Eco). Si suggerisce di utilizzare il ciclo rapido a intervalli regolari e quello completo solo in caso di forno molto sporco.



### PREFERITI

Per richiamare la lista delle 10 funzioni preferite.



### IMPOSTAZIONI

Per regolare le impostazioni del forno.

Attivando la modalità "ECO", la luminosità del display si riduce e la luce si spegne dopo 1 minuto per risparmiare energia. Il display si riattiva automaticamente premendo un tasto qualsiasi.

Se la modalità "DEMO" è impostata su "On", tutti i comandi sono operativi e i menu sono disponibili ma il forno non viene riscaldato. Per disattivare questa modalità, accedere a "DEMO" dal menu "IMPOSTAZIONI" e scegliere "Off".

Selezionando "RESET", l'apparecchio si spegne e vengono ripristinate le impostazioni della prima accensione. Tutte le impostazioni successive vengono cancellate.

# PRIMO UTILIZZO

## 1. SELEZIONARE LA LINGUA

Alla prima accensione, è necessario impostare lingua e ora:  
Sul display compare "English".



Premere + o — per scorrere tra le lingue disponibili e selezionare quella desiderata.

Premere ✓ per confermare la selezione.

Nota: la lingua potrà essere cambiata successivamente selezionando "LINGUA" nel menu "IMPOSTAZIONI", accessibile premendo .

## 2. IMPOSTARE L'ASSORBIMENTO DI POTENZA

Il forno è programmato per assorbire una potenza elettrica compatibile con una rete domestica di capacità superiore a 3 kW (16): nel caso si disponga di una potenza inferiore, è necessario diminuire questo valore (13).

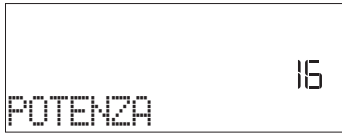

Premere + o — per selezionare 16 "Alto" o 13 "Basso" e premere ✓ per confermare.

## 3. IMPOSTARE L'ORA

Dopo avere selezionato la potenza, è necessario impostare l'ora: sul display lampeggiano le due cifre relative all'ora.

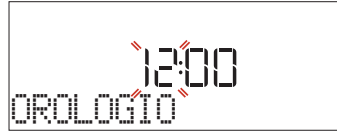

Premere + o — per impostare l'ora corrente e premere ✓ : sul display lampeggiano le due cifre relative ai minuti.

Premere + o — per impostare i minuti e premere ✓ per confermare.

Nota: Dopo una prolungata interruzione di corrente potrebbe essere necessario impostare nuovamente l'ora. Selezionare "OROLOGIO" nel menu "IMPOSTAZIONI", accessibile premendo .

## 4. RISCALDARE IL FORNO

Un nuovo forno può rilasciare degli odori dovuti alla lavorazione di fabbrica: questo è normale. Prima di cucinare gli alimenti è dunque raccomandato di riscaldare a vuoto il forno per rimuovere ogni odore. Rimuovere protezioni di cartone o pellicole trasparenti e togliere gli accessori dal forno. Riscaldare il forno a 200°C per circa 1 ora utilizzando preferibilmente una funzione ventilata ("Termoventilato" o "Ventilato").

Nota: è opportuno ventilare la stanza durante e dopo il primo utilizzo.

# USO QUOTIDIANO

## 1. SELEZIONARE UNA FUNZIONE

Premere  per accendere il forno: il display mostrerà l'ultima funzione utilizzata o il menu principale.

Per selezionare una funzione è possibile premere l'icona corrispondente (per le funzioni principali) oppure scegliere la voce desiderata da un menu: Per selezionare una funzione da un menu (il display mostrerà la prima voce disponibile), premere + o — per selezionare la voce desiderata, quindi premere ✓ per confermare.

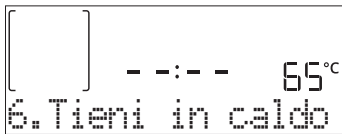

## 2. IMPOSTARE LA FUNZIONE

Dopo avere selezionato la funzione desiderata è possibile modificare i valori. Il display mostra in sequenza i valori che è possibile modificare. Premendo << è possibile modificare nuovamente l'impostazione precedente.

### TEMPERATURA / LIVELLO GRILL



Quando il valore lampeggia sul display, premere + o — per regolarlo, quindi premere ✓ per confermare e



procedere con le impostazioni seguenti (per i valori che è possibile modificare).

Usare la stessa procedura per impostare la potenza del grill: Sono disponibili tre livelli di potenza per il grill: 3 (alto), 2 (medio), 1 (basso).

Nota: una volta attivata la funzione, sarà possibile modificare la temperatura o la potenza del grill usando + o —.

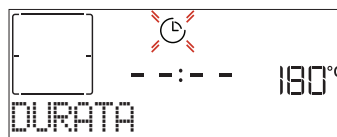
### DURATA



Quando l'icona  lampeggia sul display, premere + o — per impostare il tempo di cottura desiderato, quindi premere ✓ per confermare. È possibile non impostare la durata se si preferisce gestire manualmente il tempo di cottura: Premere ✓ o  per confermare e avviare la funzione. Selezionando questa modalità non è possibile programmare un avvio ritardato.

Nota: durante la cottura, premendo  è possibile regolare il tempo impostato: premere + o — per modificare il valore, quindi premere ✓ per confermare.



### FINE COTTURA (AVVIO RITARDATO)

In molte funzioni, una volta impostato un tempo di cottura è possibile posticipare l'avvio della funzione programmando l'ora di fine. Il display mostra l'ora di fine mentre l'icona  lampeggia.



Premere  $+ o -$  per impostare l'ora di fine cottura desiderata, quindi premere  $\checkmark$  per confermare e attivare la funzione. Inserire il cibo nel forno e chiudere la porta: la funzione si avvierà automaticamente dopo un periodo di tempo calcolato per terminare la cottura all'orario impostato.

Nota: programmare l'avvio ritardato di una cottura, disattiva in ogni caso la fase di preriscaldamento del forno: la temperatura desiderata viene raggiunta gradualmente, quindi i tempi di cottura si allungheranno leggermente rispetto a quanto indicato nella tabella di cottura. Durante il tempo di attesa, è possibile premere  $+ o -$  per regolare l'ora di fine programmata oppure premere  $\ll$  per modificare altre impostazioni. Premendo , è possibile alternare la visualizzazione tra l'ora di fine cottura e la durata.

### 6<sup>th</sup> SENSE

Queste funzioni selezionano automaticamente la modalità, la temperatura e la durata di cottura più adatte per ottenere risultati ottimali.

Alla richiesta, sarà sufficiente indicare le caratteristiche degli alimenti per ottenere un risultato ottimale.

#### PESO / ALTEZZA (LIVELLI TEGLIA ROTONDA)



Per impostare questa funzione correttamente, seguire le indicazioni che compaiono sul display, impostare i valori desiderati premendo  $+ o -$ , quindi premere  $\checkmark$  per confermare.

#### GRADO DI COTTURA / DORATURA

In alcune funzioni 6<sup>th</sup> Sense è possibile regolare il grado di cottura.

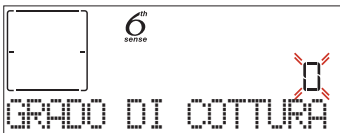

Alla richiesta, premere  $+ o -$  per selezionare il livello desiderato tra la cottura al sangue (-1) e un risultato ben cotto (+1). Premere  $\checkmark$  o  per confermare e avviare la funzione.

Allo stesso modo, in alcune funzioni 6<sup>th</sup> Sense è possibile regolare il grado di doratura tra un valore minimo (-1) e un valore massimo (+1).

### 3. AVVIARE LA FUNZIONE

Dopo avere confermato i valori predefiniti o avere applicato le impostazioni preferite, premere  per attivare la funzione prescelta.

Se è stato impostato un avvio ritardato, premendo  sarà possibile annullare il ritardo e avviare subito la funzione programmata.

Nota: dopo avere selezionato una funzione, il display consiglia il livello più adatto per quella funzione.

La funzione avviata può essere interrotta in qualsiasi momento premendo .

Se il forno è caldo e la funzione prevede una determinata temperatura massima, sul display compare un messaggio corrispondente. Premere  $\ll$  per tornare alla schermata precedente e scegliere un'altra funzione, oppure attendere il completo raffreddamento del forno.

### 4. PRERISCALDAMENTO

In alcune funzioni, è prevista una fase di preriscaldamento del forno: una volta avviata la funzione, il display segnala che si è attivata la fase di preriscaldamento.

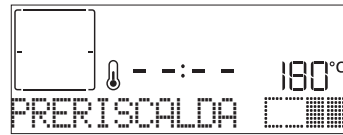

Al termine di questa fase, un segnale acustico e il display indicheranno che il forno ha raggiunto la temperatura impostata e comparirà la richiesta "AGG. ALIMENTO". A questo punto aprire la porta, infornare gli alimenti, chiudere la porta e avviare la cottura premendo  $\checkmark$  o .

Nota: inserire gli alimenti nel forno prima della fine del preriscaldamento può compromettere i risultati di cottura. Aprendo la porta durante la fase di preriscaldamento, questa si interrompe temporaneamente.

Il tempo di cottura impostato non prevede la fase di preriscaldamento. La temperatura finale del forno può essere modificata usando  $+ o -$ .

### 5. METTERE IN PAUSA LA COTTURA / GIRARE O CONTROLLARE GLI ALIMENTI

Aprendo la porta, le resistenze vengono disattivate e la cottura viene temporaneamente interrotta.

Per riprendere la cottura, chiudere la porta.

Alcune funzioni 6<sup>th</sup> Sense prevedono che gli alimenti vengano girati durante la cottura.



Questa richiesta sarà segnalata da un segnale acustico e da un messaggio corrispondente sul display. Aprire la porta, eseguire l'operazione indicata sul display, chiudere la porta e premere  per continuare la cottura.

Allo stesso modo, quando manca il 10% del tempo di cottura impostato, il forno richiede di controllare gli alimenti.

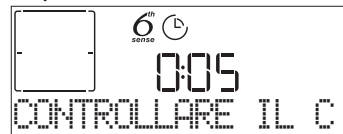



Questa richiesta sarà segnalata da un segnale acustico e da un messaggio corrispondente sul display. Controllare gli alimenti, chiudere la porta e premere  o  $\checkmark$  per continuare la cottura.

Nota: premendo  è possibile ignorare le operazioni richieste. In ogni caso, una volta trascorso un certo tempo senza che l'operazione venga eseguita, il forno riprende automaticamente la cottura.

## 6. FINE COTTURA

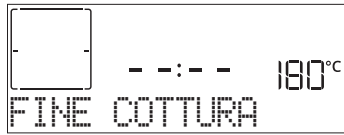
Un segnale acustico e il display avviseranno che la cottura è terminata.





Premere  per continuare la cottura in modalità manuale (senza timer) o premere  per prolungare il tempo di cottura impostando una nuova durata. In entrambi i casi, i parametri di cottura saranno mantenuti.

## DORATURA

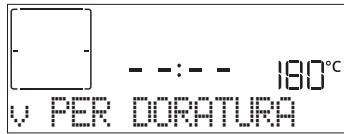
Con alcune funzioni, alla fine della cottura il forno consente di dorare la superficie del cibo grazie all'utilizzo del grill.







Quando il display mostra il messaggio corrispondente, premendo  viene avviato un ciclo di doratura di cinque minuti. Questa funzione può essere interrotta in qualsiasi momento premendo  per spegnere il forno.

## . PREFERITI

Al termine della cottura, sul display compare un messaggio che propone di salvare la funzione nella lista dei preferiti con un numero da 1 a 10.





Se si desidera salvare la funzione tra i preferiti e memorizzare le impostazioni correnti per usi successivi premere , oppure premere  per ignorare la richiesta. Dopo avere premuto , premere  per selezionare il numero di posizione, quindi premere  per confermare.

Nota: se la memoria è piena o la posizione è già occupata, viene chiesto di confermare la sovrascrittura della funzione precedente.

Per richiamare successivamente le funzioni salvate premere : il display mostrerà la lista delle funzioni preferite.



Premere  per selezionare la funzione, confermarla premendo  e attivarla premendo .

## . PULIZIA AUTOMATICA - PIROLISI







**Non toccare il forno durante il ciclo di pirolisi. Tenere i bambini e gli animali lontani dal forno durante e dopo (fino a una completa areazione della stanza) il ciclo di pirolisi.**

Prima di attivare la funzione rimuovere tutti gli accessori

dal forno, comprese le guide laterali. Se il forno è installato sotto un piano di cottura, accertarsi che durante il ciclo di pulizia automatica i bruciatori o le piastre elettriche siano spente. Per un risultato ottimale, rimuovere i residui in eccesso dalla cavità e pulire il vetro interno dello sportello prima di usare la funzione di pirolisi. Si consiglia di attivare la funzione di pirolisi soltanto se l'apparecchio è molto sporco o emana cattivi odori durante la cottura.



Premere  per visualizzare "Pirolisi" sul display.





Premere  o  per selezionare il ciclo desiderato, quindi premere  per confermare. Dopo avere selezionato un ciclo, è possibile premere  o  per impostare l'ora di fine cottura (o di avvio ritardato) e premere  per confermare. Alla richiesta, pulire la porta e rimuovere tutti gli accessori, quindi chiudere la porta e premere : il forno avvia il ciclo di autopulizia e la porta si blocca automaticamente: sul display compare un messaggio di avviso mentre un conto alla rovescia indica lo stato di avanzamento del ciclo in corso.

A ciclo ultimato, la porta rimane bloccata fino a quando non viene raggiunta una temperatura sicura.



## . CONTA MINUTI

Solo quando il forno è spento, è possibile utilizzare il display come contaminuti. Per attivare questa funzione, assicurarsi che il forno sia spento e premere  o : sul display lampeggerà l'icona .

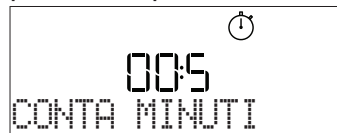
Premere  o  per impostare il tempo desiderato, quindi premere  per attivare il timer.





Un segnale acustico e il display avviseranno che il conto alla rovescia è terminato.

Nota: il conta minuti non attiva nessun ciclo di cottura. Premere  o  per modificare il tempo impostato sul timer.

Dopo avere attivato il conta minuti, è anche possibile selezionare e attivare una funzione.

Premere  per accendere il forno, quindi selezionare la funzione desiderata.

Una volta avviata la funzione, il timer continuerà autonomamente il conto alla rovescia senza interferire sulla funzione stessa.

Nota: Durante questa fase non sarà possibile vedere il conta minuti (sarà visualizzata solo l'icona ) , ma il conto alla rovescia continuerà. Per tornare a visualizzare il conta minuti, premere  per interrompere la funzione attualmente in corso.

## . BLOCCO TASTI

Per bloccare i tasti, tenere premuto  per almeno cinque secondi. Per disattivare, ripetere la stessa procedura.





Nota: questa funzione può essere attivata anche durante la cottura. Per ragioni di sicurezza, è possibile spegnere il forno in ogni momento premendo .

### USO DELLA SONDA CARNE (SE PRESENTE)

La sonda permette di misurare la temperatura interna della carne durante la cottura per garantire che raggiunga il valore ottimale. La temperatura del forno può variare in base alla funzione selezionata, ma la cottura è sempre programmata per terminare al raggiungimento della temperatura specificata. Dopo avere inserito la sonda, viene emesso un segnale acustico e sul display compare il messaggio "Sonda connessa".



Selezionare la funzione desiderata tra quelle compatibili (Statico, Termoventilato, Ventilato, Turbo Grill, ECO Termoventilato, Maxi Cooking, funzioni 6<sup>th</sup> Sense).

Sul display compare la richiesta di impostare la temperatura finale della sonda: premere + o - per programmarla e premere ✓ per impostare i parametri di cottura successivi.

Poiché la cottura è programmata per terminare al raggiungimento della temperatura impostata, non è possibile programmare un tempo di cottura o un orario di fine cottura. La luce resterà accesa finché la sonda non sarà rimossa.





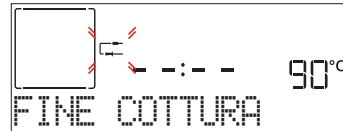











Se la sonda viene rimossa durante la cottura, il processo continuerà nella modalità tradizionale (senza timer).

Un segnale acustico e un messaggio sul display avviseranno quando la sonda avrà raggiunto la temperatura desiderata.



Nota: per cambiare le impostazioni in un momento successivo, premere + o - per modificare la temperatura della sonda o premere << per cambiare altre impostazioni. Un segnale acustico e un messaggio sul display indicheranno se l'uso della sonda non è compatibile con l'operazione selezionata. In questo caso, rimuovere la sonda.

## 6<sup>th</sup> sense TABELLA DI COTTURA

CATEGORIE DI ALIMENTI		QUANTITÀ	GIRARE (DEL TEMPO DI COTTURA)	LIVELLO E ACCESSORI
LASAGNA	-	0,5 - 3 kg	-	2 
CARNE	Manzo arrosto	Arrosto (imp. cottura 0)	-	3 
		Hamburger (imp. cottura 0)	1,5 - 3 cm	3/5 
		Arrosto - cottura lenta (grado di cottura 0) *	0,6 - 2 kg **	3 
	Maiale-arrosto	Arrosto	0,6 - 2,5 kg **	3 
		Stinco *	0,5 - 2,0 kg **	3 
		Salsicce & wurstel	1,5 - 4 cm	2/3 
	Vitello-arrosto *	0,6 - 2,5 kg **	3 	
	Agnello-arrosto	Arrosto (grado di cottura 0) *	0,6 - 2,5 kg **	2 
		Coscia (grado di cottura 0) *	0,5 - 2,0 kg **	2 
	Pollo-arrosto	Intero	0,6 - 3 kg **	2 
		Intero ripieno *	0,6 - 3 kg **	2 
		Filetto & petto	1 - 5 cm	2/3 
	Tacchino intero-arrosto	Intero *	0,6 - 3 kg **	2 
		Intero ripieno *	0,6 - 3 kg **	2 
Spiedini	1 griglia	1/2	5 	

	CATEGORIE DI ALIMENTI	QUANTITÀ	GIRARE (DEL TEMPO DI COTTURA)	LIVELLO E ACCESSORI
PESCE	Filetti	0,5 - 3 cm	-	
	Filetti-surgelati	0,5 - 3 cm	-	
VERDURE	Verdure-arrostite	Patate	0,5 - 1,5 kg	
		Verdure-ripiene	0,1 - 0,5 kg l'una	
		Verdure-arrostite	0,5 - 1,5 kg	
	Verdure-gratinate	Patate	1 teglia	
		Pomodori	1 teglia	
		Peperoni	1 teglia	
		Broccoli	1 teglia	
		Cavolfiori	1 teglia	
		Altro	1 teglia	
		TORTE & DOLCI	Torte lievitate	Pan di spagna
PasticcERIA & torte ripiene	Biscotti	0,2 - 0,6 kg		
	Bignè	1 teglia		
	Crostata	0,4 - 1,6 kg		
	Strudel	0,4 - 1,6 kg		
	Torta ripiena alla frutta	0,5 - 2 kg		
TORTE SALATE	-	0,8 - 1,2 kg	-	
PANE	Panini	60 - 150 g l'uno	-	
	Pane in cassetta	400 - 600 g l'una	-	
	Pane grande	0,5 - 2,0 kg	-	
	Baguette	200 - 300 g l'una	-	
PIZZA	Sottile	Teglia rotonda	-	
	Alta	Teglia rotonda	-	
	Surgelata	Livelli 1 - 4	-	

\* Solo in alcuni modelli. Funzione disponibile solo in combinazione con la sonda carne.

\*\* Quantità consigliata.

ACCESSORI



Griglia



Pirofila o tortiera  
su griglia



Leccarda /  
piastra dolci o teglia  
su griglia



Leccarda / teglia































































































Leccarda con  
500 ml di acqua



Sonda carne  
(se in dotazione)

# TABELLA DI COTTURA

RICETTA	FUNZIONE	PRERISCALDAMENTO	TEMPERATURA (°C)	DURATA (MIN)	RIPIANO E ACCESSORI
Torte lievitate / Pan di Spagna		Sì	170	30 - 50	
		Sì	160	30 - 50	
		Sì	160	30 - 50	 
Torte ripiene (cheesecake, strudel, torta di mele)		Sì	160 - 200	30 - 85	
		Sì	160 - 200	35 - 90	 
Biscotti / Pasta frolla		Sì	150	20 - 40	
		Sì	140	30 - 50	
		Sì	140	30 - 50	 
		Sì	135	40 - 60	  
Tortine / Muffin		Sì	170	20 - 40	
		Sì	150	30 - 50	
		Sì	150	30 - 50	 
		Sì	150	40 - 60	  
Bigné		Sì	180 - 200	30 - 40	
		Sì	180 - 190	35 - 45	 
		Sì	180 - 190	35 - 45 *	  
Meringhe		Sì	90	110 - 150	
		Sì	90	130 - 150	 
		Sì	90	140 - 160 *	  
Pane / Pizza / Focaccia		Sì	190 - 250	15 - 50	
		Sì	190 - 230	20 - 50	 
Pizza (sottile, alta, focaccia)		Sì	220 - 240	25 - 50 *	  
Pizza surgelata		Sì	250	10 - 15	
		Sì	250	10 - 20	 
		Sì	220 - 240	15 - 30	  
Torte salate (torta di verdure, quiche)		Sì	180 - 190	45 - 55	
		Sì	180 - 190	45 - 60	 
		Sì	180 - 190	45 - 70 *	  
Vols-au-vent / Salatini di pasta sfoglia		Sì	190 - 200	20 - 30	
		Sì	180 - 190	20 - 40	 
		Sì	180 - 190	20 - 40 *	  
Lasagna / Sformati / Pasta al forno / Cannelloni		Sì	190 - 200	45 - 65	
Agnello / Vitello / Manzo / Maiale (1 kg)		Sì	190 - 200	80 - 110	

FUNZIONI



Statico



Termoventilato



Ventilato



Grill



Turbo Grill



Maxi Cooking



Cook 4

Eco  
Termoventilato

RICETTA	FUNZIONE	PRERISCALDAMENTO	TEMPERATURA (°C)	DURATA (MIN)	RIPIANO E ACCESSORI
Arrosto di maiale con cotenna 2 kg		-	170	110 - 150	
Pollo / Coniglio / Anatra (1 kg)		Sì	200 - 230	50 - 100	
Tacchino / Oca (3 kg)		Sì	190 - 200	80 - 130	
Pesce al forno / al cartoccio (filetti, intero)		Sì	180 - 200	40 - 60	
Verdure ripiene (pomodori, zucchine, melanzane)		Sì	180 - 200	50 - 60	
Pane tostato		-	3 (Alta)	3 - 6	
Filetti / Tranci di pesce		-	2 (media)	20 - 30 **	
Salsicce / Spiedini / Costine / Hamburger		-	2 - 3 (media - alto)	15 - 30 **	
Pollo arrosto (1-1,3 kg)		-	2 (media)	55 - 70 ***	
Cosciotto d'agnello / Stinco		-	2 (media)	60 - 90 ***	
Patate arrosto		-	2 (media)	35 - 55 ***	
Verdure gratinate		-	3 (Alta)	10 - 25	
Biscotti	Biscotti	Sì	135	50 - 70	
Crostate	Crostate	Sì	170	50 - 70	
Pizza tonda	Pizza	Sì	210	40 - 60	
Pasto completo: Crostata di frutta (livello 5) / Lasagne (livello 3) / Carne (livello 1)		Sì	190	40 - 120 *	
Pasto completo: Crostata di frutta (livello 5) / Verdure arrosto (livello 4) / Lasagne (livello 2) / Tagli di carne (livello 1)	Menu	Sì	190	40 - 120 *	
Lasagne e carne		Sì	200	50 - 100 *	
Carne e patate		Sì	200	45 - 100 *	
Pesce e verdure		Sì	180	30 - 50 *	
Arrosti ripieni		-	200	80 - 120 *	
Carne in pezzi (coniglio, pollo, agnello)		-	200	50 - 100 *	

\* Il tempo di cottura è indicativo: le pietanze possono essere tolte dal forno in tempi differenti secondo preferenza.

\*\* Girare gli alimenti a metà cottura.

\*\*\* Ruotare il cibo a due terzi di cottura se necessario.

#### COME LEGGERE LA TABELLA DI COTTURA

La tabella indica la funzione, gli accessori e il livello migliore da utilizzare per cuocere svariati tipi di cibo. I tempi di cottura si intendono dall'introduzione degli alimenti nel forno, escluso il preriscaldamento (dove richiesto). Le temperature e i tempi di cottura sono indicativi e dipendono dalla quantità di cibo e dal tipo di accessori. Utilizzare inizialmente i valori più bassi consigliati e, se il risultato della cottura non è quello desiderato, passare a quelli più alti. Si consiglia di utilizzare gli accessori in dotazione e tortiere o teglie possibilmente in metallo scuro. È possibile utilizzare anche tegami e accessori in pyrex o in ceramica, ma occorre considerare che i tempi di cottura si allungheranno leggermente.

ACCESSORI



Griglia



Pirofila o tortiera su griglia



Leccarda / piastra dolci o teglia su griglia



Leccarda / teglia



Leccarda con 500 ml di acqua



Sonda carne (se in dotazione)

## PULIZIA E MANUTENZIONE

Assicurarsi che il forno si sia raffreddato prima di eseguire ogni operazione.

Non utilizzare apparecchi a vapore.

Non usare pagliette metalliche, panni abrasivi e detersivi abrasivi o corrosivi che possano danneggiare le superfici.

Utilizzare guanti protettivi.

Il forno deve essere disconnesso dalla rete elettrica prima di effettuare operazioni di manutenzione.

### SUPERFICI ESTERNE

- Pulire le superfici con un panno in microfibra umido. Se molto sporche, aggiungere qualche goccia di detersivo neutro. Asciugare con un panno asciutto.
- Non usare detersivi corrosivi o abrasivi. Se inavvertitamente uno di questi prodotti dovesse venire a contatto con le superfici, pulire subito con un panno in microfibra umido.

### SUPERFICI INTERNE

- Dopo ogni uso, lasciare raffreddare il forno e pulirlo preferibilmente quando è ancora tiepido per rimuovere incrostazioni e macchie dovute a residui di cibo. Per asciugare la condensa dovuta alla cottura di alimenti ad alto contenuto di acqua, usare a forno freddo un panno o una spugna.

- Pulire i vetri della porta con detersivi liquidi specifici.
- Per facilitare la pulizia della porta è possibile rimuoverla.

### ACCESSORI

Mettere a bagno gli accessori con detersivo per piatti dopo l'uso, maneggiandoli con guanti da forno, se ancora caldi. I residui di cibo possono essere rimossi con una spazzola per piatti o con una spugna.

## RIMOZIONE E MONTAGGIO DELLA PORTA

1. Per rimuovere la porta, aprirla completamente e abbassare i fermi fino alla posizione di sblocco.

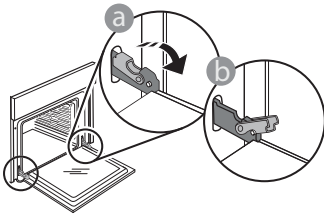

2. Chiudere la porta fino a quando è possibile. Prendere saldamente la porta con entrambe le mani, evitando di tenerla per la maniglia. Per estrarla facilmente, continuare a chiuderla e contemporaneamente tirarla verso l'alto finché non esce dalle sedi. Togliere la porta e appoggiarla su un piano morbido.

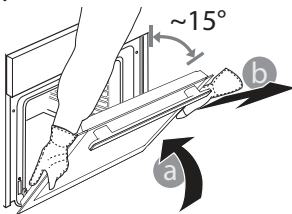

3. Per rimontare la porta, avvicinarla al forno allineando i ganci delle cerniere alle proprie sedi e ancorare la parte superiore agli alloggiamenti.
4. Abbassare la porta e poi aprirla completamente. Abbassare i fermi nella posizione originale: fare attenzione che siano completamente abbassati.

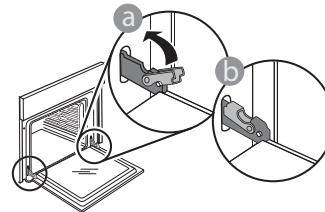

Sarà necessario applicare una leggera pressione per assicurare il corretto posizionamento dei fermi.

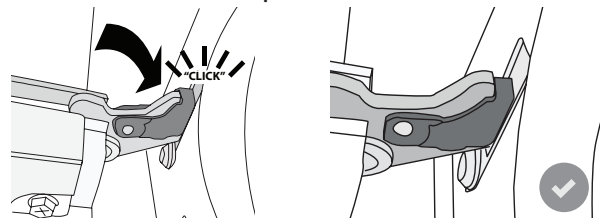

5. Provare a chiudere la porta, verificando che sia allineata al pannello di controllo. Se non lo fosse, ripetere tutte le operazioni: funzionando male, la porta potrebbe danneggiarsi.



## SOSTITUZIONE DELLA LAMPADINA

1. Scollegare il forno dalla rete elettrica.
2. Svitare la copertura della lampada, sostituire la lampada e avvitarla di nuovo il coperchio della lampada.
3. Ricollegare il forno alla rete elettrica.

Nota: usare solo lampade alogene da 20-40 W/230 ~ V tipo G9, T 300 °C. La lampada utilizzata nel prodotto è specifica per elettrodomestici e non è adatta per l'illuminazione di ambienti domestici (Regolamento (CE) 244/2009). Le lampadine sono disponibili presso il Servizio Assistenza.

- In caso di impiego di lampade alogene, non maneggiarle a mani nude, per evitare che vengano danneggiate dalle impronte digitali. Non far funzionare il forno senza prima aver riposizionato il coperchio.

## RISOLUZIONE DEI PROBLEMI

PROBLEMA	POSSIBILI CAUSE	SOLUZIONE
Il forno non funziona.	Interruzione di corrente elettrica. Disconnessione dalla rete principale.	Verificare che ci sia tensione in rete e che il forno sia collegato all'alimentazione elettrica. Spegnerlo e riaccenderlo e verificare se l'inconveniente persiste.
Il display mostra la lettera "F" seguita da un numero o una lettera.	Il forno è guasto.	Spegnerlo e riaccenderlo e verificare se l'inconveniente persiste. Provare a ripristinare l'apparecchio selezionando "RESET" dal menu "IMPOSTAZIONI". Contattare il più vicino Servizio Assistenza Clienti e specificare il numero che segue la lettera "F".
Il forno non si riscalda.	Se la modalità "DEMO" è impostata su "On", tutti i comandi sono operativi e i menu sono disponibili ma il forno non viene riscaldato. Sul display appare la scritta "DEMO" ogni 60 secondi.	Accedere a "DEMO" dal menu "IMPOSTAZIONI" e scegliere "Off".
La luce si spegne.	La modalità "ECO" è impostata su "On".	Accedere a "ECO" dal menu "IMPOSTAZIONI" e scegliere "Off".
La porta non si apre.	Ciclo di pulizia in corso.	Attendere il termine della funzione e lasciare raffreddare il forno.
L'interruttore generale dell'impianto domestico si spegne.	La potenza dell'apparecchio non è regolata correttamente.	Verificare che la rete domestica abbia una portata nominale di almeno 3 kW. In caso contrario, ridurre la potenza a 13 Ampere. Selezionare "POTENZA" dal menu "IMPOSTAZIONI" e scegliere "BASSO".



Per scaricare le istruzioni di sicurezza, il manuale d'uso, la scheda tecnica e i dati energetici:

- Visitare il sito web [docs.whirlpool.eu](http://docs.whirlpool.eu)
- Usare il codice QR
- Oppure, **contattare il Servizio Assistenza Tecnica** (al numero di telefono riportato sul libretto di garanzia). Prima di contattare il Servizio Assistenza Tecnica, prepararsi a fornire i codici riportati sulla targhetta matricola del prodotto.

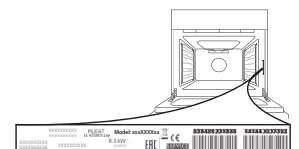



**OBRIGADO POR COMPRAR UM PRODUTO WHIRLPOOL**  
 Para beneficiar de uma assistência mais completa, registe o seu produto em [www.whirlpool.eu/register](http://www.whirlpool.eu/register)



**Leia as instruções de segurança com atenção antes de usar o aparelho.**

## DESCRIÇÃO DO PRODUTO

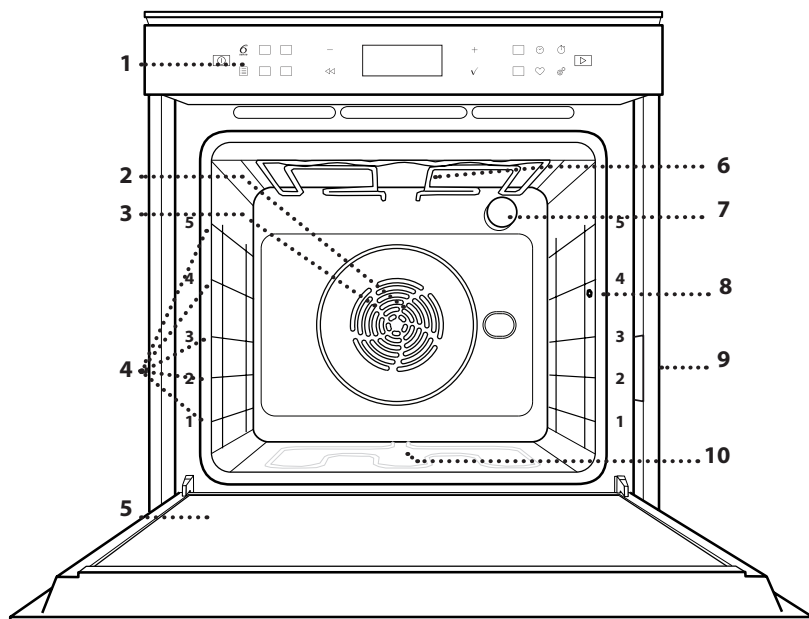

1. Painel de controlo
2. Ventoinha
3. Resistência circular (não visível)
4. Guias de nível (o nível está indicado na parte frontal do forno)
5. Porta
6. Resistência superior/grelhador
7. Lâmpada
8. Ponto de inserção do termómetro de carne
9. Placa de identificação (não remover)
10. Resistência inferior (não visível)

## DESCRIÇÃO DO PAINEL DE CONTROLO

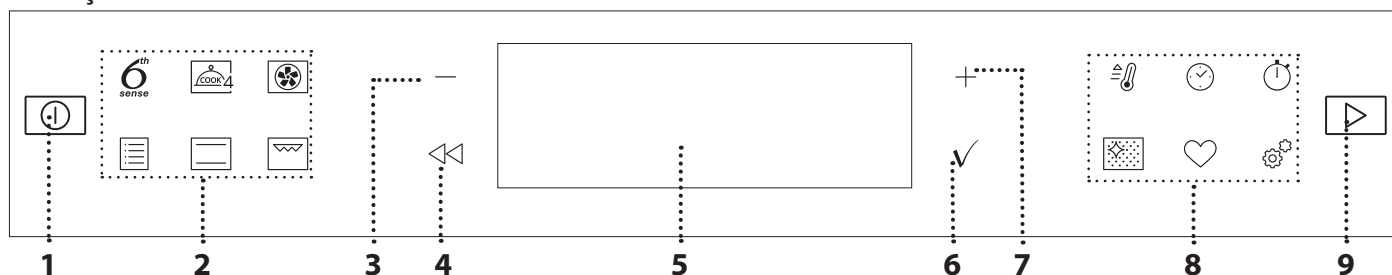

### 1. ON / OFF

Para ligar e desligar o forno e parar uma função ativa.

### 2. ACESSO DIRETO ÀS FUNÇÕES

Para aceder rapidamente às funções e ao menu principal.

### 3. BOTÃO DE NAVEGAÇÃO MENOS

Para percorrer um menu e diminuir as configurações, valores ou uma função.

### 4. RETROCEDER

Para regressar ao ecrã anterior. Permite mudar as configurações durante a cozedura.

### 5. VISOR

Para confirmar a seleção de uma função ou de um valor definido.

### 7. BOTÃO DE NAVEGAÇÃO MAIS

Para percorrer um menu e aumentar as configurações, valores ou uma função.

### 8. OPÇÕES / ACESSO DIRETO ÀS FUNÇÕES

Para aceder rapidamente às funções, duração, definições e preferidos.

### 9. INICIAR

Para iniciar uma função usando as definições especificadas ou básicas.

# ACESSÓRIOS

## GRELHA METÁLICA

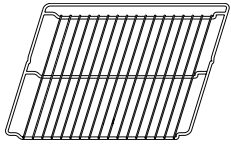

Adequadas para a cozedura de alimentos ou como suporte de recipientes de cozedura, formas para assar e quaisquer outros adequados para fornos.

## TABULEIRO COLETOR

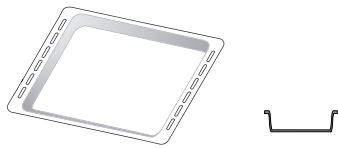

Para utilização como tabuleiro para cozinhar carne, peixe, legumes, focaccia, etc., ou para recolher sucos quando posicionado por baixo da grelha metálica.

## TABULEIRO PARA ASSAR

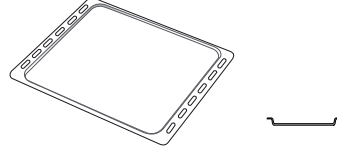

Para a cozedura de todos os produtos de padaria e pastelaria, mas também para assados, peixe em papelote, etc.

## CALHAS DESLIZANTES\*

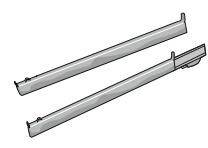

Para facilitar a inserção ou a remoção de acessórios.

## TERMÓMETRO DE CARNE\*

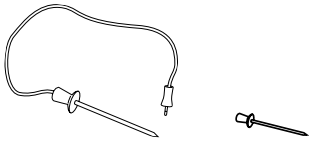

Serve para medir a temperatura interior do alimento durante a cozedura.

\* Disponível apenas em determinados modelos

O número e o tipo de acessórios pode variar de acordo com o modelo adquirido.

Pode adquirir separadamente outros acessórios no Serviço Pós-venda.

## COMO INTRODUIZIR A GRELHA E OUTROS ACESSÓRIOS

Introduza a grelha na horizontal, fazendo-a deslizar pelas guias, e assegure-se de que a extremidade elevada está virada para cima.

Outros acessórios, como o tabuleiro coletor e o tabuleiro para assar são introduzidos horizontalmente, da mesma forma que a grelha.

## RETIRAR E REPOR AS GUIAS DE NÍVEL

- Para retirar as guias de nível, levante as guias e, suavemente, puxe a parte inferior e extraia-a do respetivo suporte: Agora, as guias de nível podem ser retiradas.
- Para repor as guias de nível, comece por inseri-las no suporte superior. Mantendo-as subidas, faça-as deslizar para o interior do compartimento de cozedura e, em seguida, posicione-as no suporte inferior.

## COMO INSTALAR AS CALHAS DESLIZANTES (CASO EXISTAM)

Retire as guias de nível do forno e remova o plástico de proteção das corredeiras.

Fixe o encaixe superior da corredeira à guia de nível e faça-a deslizar até parar. Baixe o outro encaixe para o posicionar.

Para fixar a guia, pressione a parte inferior do dispositivo de fixação firmemente contra a guia de nível. Assegure-se de que as corredeiras se movem livremente. Repita estes procedimentos para a outra guia de nível, no mesmo nível.

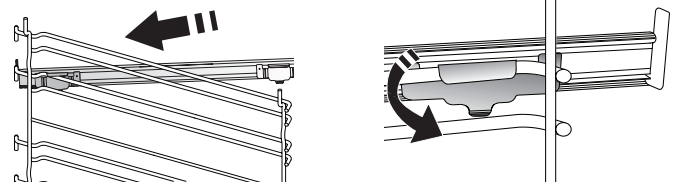

Nota: As corredeiras podem ser instaladas em qualquer nível.

## UTILIZAR O TERMÓMETRO DE CARNE (SE EXISTENTE)

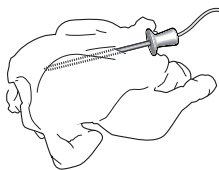

forno.

Introduza a sonda de temperatura no interior da carne, evitando ossos e zonas de gordura. Tratando-se de aves, insira o termómetro no sentido do comprimento, no centro do peito, evitando as cavidades.

Coloque os alimentos no forno e ligue a ficha, introduzindo-a na ligação existente no lado direito do compartimento de cozedura do

## FUNÇÕES



### 6<sup>th</sup> SENSE

Estas funções permitem uma cozedura totalmente automática para todos os tipos de alimentos (lasanha, carne, peixe, legumes, bolos e pastéis, bolos salgados, pão, pizza). Para tirar o melhor partido desta função, siga as indicações na respetiva tabela de cozedura.



### COOK 4

Para cozinhar diferentes alimentos que necessitem da mesma temperatura de cozedura em quatro níveis ao mesmo tempo. Esta função pode ser utilizada para cozinhar biscoitos, bolos, pizzas redondas (também congeladas) e para preparar uma refeição completa. Siga a tabela de cozedura para obter os melhores resultados.



### AR FORÇADO

Para cozinhar diferentes alimentos, que exijam a mesma temperatura de cozedura, em diferentes níveis (três, no máximo) e em simultâneo. Esta função permite cozinhar alimentos diferentes sem transmitir odores de uns alimentos para os outros.



### TRADICIONAIS

#### • COZ. CONVECÇÃO

Para cozinhar carne, bolos com recheio apenas num tabuleiro.

#### • TURBO GRILL

Para assar peças de carne grandes (pernil, rosbife, frango). Recomendamos a utilização de um tabuleiro coletor, para recolher os sucos da cozedura: Posicione o tabuleiro em qualquer um dos níveis que se encontram por baixo da grelha e adicione 500 ml de água potável.

#### • COZEDURA CONG.

Esta função seleciona automaticamente a temperatura e o modo ideal para cozinhar 5 tipos diferentes de alimentos congelados já preparados. Não é necessário preaquecer o forno.

#### • FUNÇÕES ESPECIAIS DE COZEDURA

##### » MAXI COOKING

A função seleciona automaticamente a melhor temperatura e o melhor modo de cozedura para confeccionar peças de carne grandes (acima de 2,5 kg). Recomendamos que vire a carne durante a cozedura para que fique dourada de forma homogénea de ambos os lados. Recomenda-se ir regando a carne com molho para que não seque demasiado.

##### » FERMENTAR

Para obter a fermentação ideal de massas doces ou salgadas. Para manter a qualidade da levedação, não ativar a função se o forno ainda estiver quente após um ciclo de cozedura.

##### » DESCONGELAR

Para descongelar mais rapidamente os alimentos. É aconselhável posicionar os alimentos no nível intermédio. Sugerimos que deixe o alimento na embalagem para não secar.

##### » MANTER QUENTE

Para manter os alimentos acabados de cozinhar quentes e estaladiços.

##### » AR FORÇADO ECO

Para cozinhar peças de carne recheadas e bifes num único nível. Evita-se que os alimentos sequem excessivamente, através de uma circulação de ar suave e intermitente. Quando esta função ECO está a ser utilizada, a luz mantém-se apagada ao longo da cozedura. Para usar o ciclo ECO e, assim, otimizar o consumo de energia, a porta do forno não deve ser aberta até que os alimentos estejam completamente cozinhados.



### CONVENCIONAL

Para confeccionar qualquer tipo de prato utilizando apenas um nível.



### GRILL

Para grelhar bifes, espetadas, salsichas, gratinar legumes ou tostar pão. Ao grelhar carne, recomendamos a utilização de um tabuleiro coletor, para recolher os sucos da cozedura: posicione o tabuleiro em qualquer um dos níveis que se encontram por baixo da grelha e adicione 500 ml de água potável.



### PRÉ-AQ. RÁPIDO

Para efetuar o preaquecimento rápido do forno.



### TEMPORIZADORES

Para editar os valores da função de tempo.



### TEMPORIZADOR

Para manter o tempo sem ativar qualquer função.



### LIMPEZA AUTOMÁTICA DO FORNO - LIMPEZA PIROLÍTICA

Para eliminar os salpicos de cozedura, utilizando um ciclo a muito alta temperatura. Estão disponíveis dois ciclos de limpeza automática: um ciclo de limpeza completo (Pirolítica) e um ciclo de limpeza reduzido (Pirolítica Eco). Recomendamos a utilização do ciclo mais rápido a intervalos regulares e do ciclo completo apenas quando o forno estiver muito sujo.



### FAVORITO

Para aceder à lista das 10 funções favoritas.



### DEFINIÇÃO

Para ajustar as definições do forno.

Quando o modo Eco está ativo, a luminosidade do visor é reduzida e as luzes desligam-se para poupar energia e a lâmpada desliga após 1 minuto. Será reativado automaticamente quando algum dos botões é premido.

Quando o modo Demo está ligado, todos os comandos estão ativos e os menus disponíveis mas o forno não aquece. Para desativar este modo, procure "DEMO" no menu "DEFINIÇÃO" e seleccione "Off".

Ao selecionar "REP. DE FÁBRICA", o produto desliga e volta a ligar como na primeira vez. Todas as configurações serão apagadas.

# UTILIZAR PELA PRIMEIRA VEZ

## 1. SELECIONAR O IDIOMA

Ao ligar o aparelho pela primeira vez, terá de definir o idioma e a hora: "English" surgirá no visor.



Prima + ou - para percorrer a lista dos idiomas disponíveis e selecionar aquele que pretende.

Prima ✓ para confirmar a sua seleção.

Nota: O idioma pode ser subsequentemente mudado selecionando "IDIOMA" no menu "DEFINIÇÃO", disponível ao premir ⌂.

## 2. DEFINIR O CONSUMO DE ENERGIA

O forno está programado para consumir um nível de energia elétrica compatível com uma rede doméstica de potência superior a 3 kW (16): Se a potência que utiliza em sua casa for inferior, terá de reduzir este valor (13).



Prima + ou - para selecionar 16 "Alto" ou 13 "Baixo" e prima ✓ para confirmar.

## 3. ACERTAR A HORA

Após selecionar o consumo de energia, terá de definir a hora atual: No visor piscam os dois dígitos relativos à hora.



Prima + ou - para definir a hora atual e prima ✓ : No visor piscam os dois dígitos relativos aos minutos.

Prima + ou - para definir os minutos e prima ✓ para confirmar.

Nota: Poderá ter de acertar novamente a hora após um longo corte de energia. Selecione a opção "RELÓGIO" no menu "DEFINIÇÃO", disponível ao premir ⌂.

## 4. AQUECER O FORNO

Um forno novo pode libertar odores residuais, resultantes do processo de fabrico: isto é perfeitamente normal. Assim, antes de começar a cozinhar alimentos, recomendamos que aqueça o forno, vazio, para eliminar eventuais odores. Remova do forno qualquer elemento de proteção em cartão ou película transparente e retire quaisquer acessórios do respetivo interior. Aqueça o forno a 200 °C durante uma hora, aproximadamente, de preferência utilizando uma função com circulação de ar (por exemplo "Ar forçado" ou "Cozedura convecção").

Nota: É aconselhável arejar a cozinha após a primeira utilização do aparelho.

# UTILIZAÇÃO DIÁRIA

## 1. SELECIONAR UMA FUNÇÃO

Prima ⏏ para ligar o forno: o visor mostrará a última função principal utilizada ou o menu principal.

As funções podem ser selecionadas utilizando o ícone para as funções principais ou percorrendo o menu: Para selecionar um item de um menu (o visor mostrará o primeiro item disponível), prima + ou - para selecionar o item desejado, depois prima ✓ para confirmar.

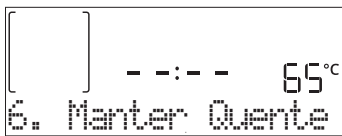

## 2. DEFINIR UMA FUNÇÃO

Após selecionar uma função, é possível alterar as suas definições. O visor irá apresentar as definições que podem ser alteradas em sequência. Ao premir ⏪ poderá repor a definição anterior novamente.

### TEMPERATURA / NÍVEL DO GRILL

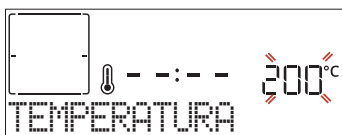

Quando o valor pisca no visor, prima + ou - para alterá-lo e prima ✓ para confirmar a sua seleção e continuar a alterar as definições seguintes (se possível).

Da mesma forma, é possível configurar o nível do grill: Existem três níveis de potência definidos para grelhar: 3 (alto), 2 (médio), 1 (baixo).

Nota: Uma vez que ativada a função, a temperatura/nível do grill podem ser mudados utilizando + ou -.

### DURAÇÃO

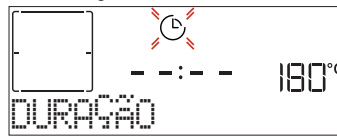

Quando o ícone ⏰ pisca no visor, prima + ou - para definir o tempo de cozedura pretendido e, em seguida, prima ✓ para confirmar. Não é necessário definir o tempo de cozedura, caso pretenda fazer a gestão da cozedura manualmente (sem duração definida): Prima ✓ ou ⏏ para confirmar e iniciar a função. Ao selecionar este modo, não pode programar um início atrasado.

Nota: Pode ajustar o tempo de cozedura definido durante a cozedura, premindo ⏰ : prima + ou - para corrigi-lo e, em seguida, prima ✓ para confirmar.



### HORA DE FIM (INÍCIO DIFERIDO)

Em muitas funções, uma vez definido um tempo de cozedura, pode atrasar o início da função, programando o seu tempo de fim. O visor apresenta o tempo de fim enquanto o ícone  pisca.



Prima + ou - para definir o final pretendido da cozedura e, em seguida, prima ✓ para confirmar e ativar a função. Coloque os alimentos no forno e feche a porta: A função inicia-se automaticamente após o período de tempo calculado para concluir a cozedura à hora programada.

Nota: Programar um início diferido da cozedura irá desativar a fase de preaquecimento do forno: O forno atinge a temperatura pretendida gradualmente, o que significa que os tempos de cozedura poderão ser ligeiramente mais longos do que os tempos indicados na tabela. Durante o tempo de espera, pode premir + ou - para corrigir o tempo final programado ou << para alterar outras definições. Ao premir , para visualizar informação, é possível alternar entre o tempo final e a duração.

### 6<sup>th</sup> SENSE

Estas funções selecionam automaticamente o melhor modo, temperatura e duração da cozedura para cozinhar, assar ou cozer todos os pratos disponíveis.

Quanto for necessário, indique apenas as características dos alimentos para obter o resultado ideal.

#### PESO / ALTURA (REDONDO-TABULEIRO-FATIAS)

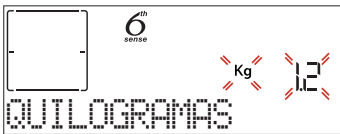

Para configurar corretamente a função, siga as indicações no visor, quando tal lhe for solicitado, e prima + ou - para configurar o valor necessário e prima ✓ para confirmar.

#### NÍVEL COZEDURA / DOURAR

Nas funções 6<sup>th</sup> Sense é possível regular o nível de preparação.

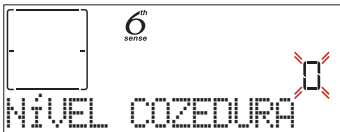

Quando tal lhe for solicitado, prima + ou - para seleccionar o nível desejado entre mal passado (-1) e bem passado (+1). Prima ✓ ou  para confirmar e iniciar a função.

Da mesma forma, em algumas funções 6<sup>th</sup> Sense, quando for permitido, é possível ajustar o nível para alourar entre baixo (-1) e alto (+1).

### 3. INICIAR A FUNÇÃO

A qualquer momento, se os valores de predefinição forem os desejados ou quando tiver aplicado as configurações requeridas, prima  para ativar a função.

Durante a fase de início diferido, prima  para ignorar esta fase e iniciar a função de imediato.

Nota: Depois de selecionada a função, o visor irá recomendar o nível mais apropriado para cada função.

Pode interromper a função a qualquer altura, premindo .

Se o forno estiver quente e a função necessitar de uma temperatura máxima específica, surgirá uma mensagem no visor. Prima << para voltar ao ecrã anterior e seleccionar uma função diferente ou aguarde até que o forno arrefeça totalmente.

### 4. PRÉ-AQUECIMENTO

Algumas funções dispõem de uma fase de pré-aquecimento do forno: Uma vez iniciada a função, o visor indica que a fase de preaquecimento foi ativada.

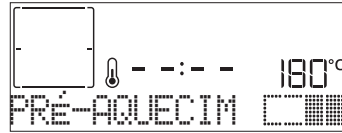

Quando esta fase terminar, será emitido um sinal sonoro e o visor indicará que o forno atingiu a temperatura definida, solicitando-lhe "ADIC. ALIMENTO". Neste momento, abra a porta, coloque os alimentos no forno, feche a porta e inicie a cozedura premindo ✓ ou .

Nota: Colocar os alimentos no forno antes de o preaquecimento estar concluído pode ter um efeito adverso no resultado final da cozedura. Abrir a porta durante a fase de preaquecimento fará com que esta seja interrompida.

O tempo de cozedura não inclui uma fase de preaquecimento. Pode sempre alterar a temperatura que pretende que o forno atinja utilizando + ou -.

### 5. PAUSA NA COZEDURA / VIRAR OU VERIFICAR ALIMENTOS

Ao abrir a porta, a cozedura pausará temporariamente, desativando os elementos de aquecimento.

Para continuar a cozedura, feche a porta.

Algumas funções 6<sup>th</sup> Sense necessitam que os alimentos sejam virados durante a cozedura.



Será emitido um sinal sonoro e o visor indicará que ação deverá realizar. Abra a porta, realize a ação indicada no visor e feche a porta; em seguida, prima  para continuar a cozinhar.

Da mesma forma, a 10% do final da cozedura, o forno indica-lhe para verificar os alimentos.

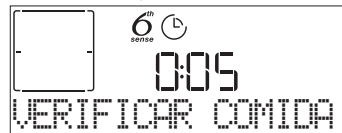

Será emitido um sinal sonoro e o visor indicará que ação deverá realizar. Verifique os alimentos, feche a porta e prima  ou ✓ para continuar a cozinhar.

Nota: Prima  para saltar estas ações. Caso contrário, se não for realizada qualquer ação após um determinado período de tempo, o forno continuará a cozinhar.

## 6. FIM DA COZEDURA

Será emitido um sinal sonoro e o visor indicará que a cozedura está concluída.

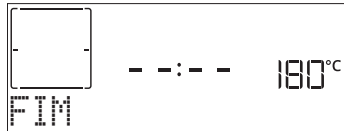

Prima para continuar a cozinhar no modo manual (sem duração definida) ou prima para prolongar o tempo de cozedura, configurando uma nova duração. Em ambos os casos, os parâmetros de cozedura serão retomados.

### DOURAR

Algumas funções do forno permitem-lhe alourar a superfície dos alimentos, ativando o grelhador quando a cozedura está concluída.

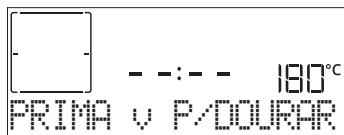

Quando o visor apresentar a mensagem relevante, prima , se necessário, para iniciar um ciclo para alourar de cinco minutos. Pode interromper a função a qualquer altura, premindo para desligar o forno.

### FAVORITO

Quando a cozedura estiver completa, o visor apresentará uma mensagem solicitando-lhe que guarde a função na sua lista de favoritos com um número entre 1 e 10.



Se quiser guardar a função como favorita e guardar as configurações atuais para uso futuro, prima , caso contrário, prima para ignorar.

Assim que premir , prima ou para selecionar a posição do número, depois prima para confirmar.

Nota: Se a memória estiver cheia ou o número que pretende já tiver sido atribuído, o forno irá perguntar se quer substituir a antiga função.

Para posterior acesso às funções que gravou, prima : O visor apresenta a sua lista de funções favoritas.



Prima ou para selecionar a função, confirme premindo e, em seguida, prima para ativar.

### LIMPEZA AUTOMÁTICA – PIROLÍTICA

**Não toque no forno durante o ciclo de limpeza pirolítica.**

**Mantenha crianças e os animais afastados do forno durante e após a execução do ciclo de limpeza pirolítica (até a divisão ter arejado totalmente).**

Retire os acessórios do forno, incluindo as guias de nível, antes de ativar esta função. Se o forno estiver

instalado por baixo de uma placa, assegure-se de que, durante a execução do ciclo de limpeza automática, os queimadores ou as placas elétricas estão desligados. Para obter os melhores resultados de limpeza, remova os resíduos em excesso do interior da cavidade do aparelho e limpe a porta de vidro interior utilizando a função de limpeza pirolítica. Recomendamos a utilização da função de Limpeza pirolítica apenas se o aparelho estiver muito sujo ou libertar maus odores durante a cozedura.

Prima para apresentar a mensagem "Pirolítica" no visor.



Prima ou para selecionar o ciclo desejado e, em seguida, prima para confirmar. Uma vez selecionado o ciclo, prima ou para definir a hora de fim (atraso) e, em seguida, prima para confirmar.

Limpe a porta e remova todos os acessórios conforme solicitado e, em seguida, feche a porta e prima no final: o forno inicia o ciclo de limpeza automática e a porta do mesmo fecha-se automaticamente: é apresentada uma mensagem de aviso no visor, juntamente com uma contagem decrescente que indica o estado do ciclo em curso.

Uma vez concluído o ciclo, a porta permanece trancada até que a temperatura no interior do forno tenha baixado para um nível seguro.

### TEMPORIZADOR

Quando o forno é desligado, o visor pode ser utilizado como um temporizador. Para ativar a função, assegure-se de que o forno está desligado e prima ou : O ícone começará a piscar no visor.

Prima ou para definir o tempo pretendido e, de seguida, prima para ativar o temporizador.



Quando o temporizador terminar a contagem decrescente do tempo programado, ouvir-se-á um sinal sonoro e esta informação será apresentada no visor.

Nota: O temporizador não ativa nenhum dos ciclos de cozedura. Prima ou para alterar o tempo definido no temporizador.

Uma vez ativado o temporizador, poderá também selecionar e ativar uma função.

Prima para ligar o forno e, em seguida, selecione a função pretendida.

Depois de iniciada a função, o temporizador continuará a sua contagem decrescente de forma independente, sem interferir com a função em si.

Nota: Durante esta fase, não é possível ver o temporizador (apenas o ícone será apresentado), que continuará a contagem decrescente em segundo plano. Para voltar ao ecrã do temporizador, prima para parar a função que está atualmente ativa.

**BLOQ. TECLADO**

Para bloquear o teclado, prima e mantenha premido << durante, pelo menos, 5 segundos. Para desbloquear, repita o procedimento.

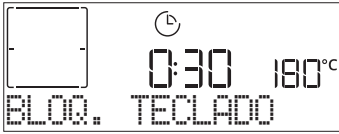

Nota: Esta função pode ser ativada também durante a cozedura. Por motivos de segurança, o forno pode ser desligado a qualquer altura premindo .

**UTILIZAR O TERMÓMETRO DE CARNE (SE EXISTENTE)**

A utilização do termómetro permite-lhe medir a temperatura interior da carne durante a cozedura para garantir que atinge a temperatura ideal. A temperatura do forno varia consoante a função selecionada, contudo, a cozedura está sempre programada para terminar assim que a temperatura especificada tenha sido alcançada. Após introduzir o termómetro no interior da carne é ativado um sinal sonoro e a mensagem "Sonda ligada" surge no visor.



Selecione a função pretendida a partir das funções

compatíveis (Convencional, Ar Forçado, Coz. Convecção, Turbo grill, Ar Forçado Eco, Maxi Cooking, 6<sup>th</sup> Sense): No visor surge uma mensagem solicitando-lhe que defina a temperatura do termómetro pretendida: Prima + ou - para definir a temperatura e ✓ para definir os parâmetros de cozedura seguintes.

Uma vez que a cozedura está programada para terminar assim que a temperatura requerida seja alcançada, não é possível definir a duração da cozedura, nem uma hora específica de fim da cozedura. A luz permanece acesa até que o termómetro seja removido.





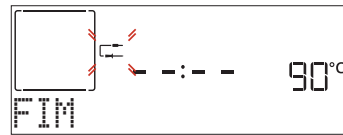















Se o termómetro for removido durante a cozedura, esta prosseguirá tradicionalmente (com uma duração indeterminada).





































Será emitido um sinal sonoro e o visor indicará que o termómetro atingiu a temperatura pretendida.



Nota: Para alterar as definições posteriormente, prima + ou - para o termómetro de carne ou prima << para outras definições. É emitido um sinal sonoro e apresentada uma mensagem indicando se a utilização do termómetro é incompatível com a ação realizada. Se for o caso, remova o termómetro.

6<sup>th</sup>  
sense**TABELA DE COZEDURA**

CATEGORIAS DE ALIMENTOS		QUANTIDADE	VIRAR (DO TEMPO DE COZEDURA)	NÍVEL E ACESSÓRIOS
LASANHA	-	0,5 - 3 kg	-	2 
CARNE	Carne assada	Assado (grau de preparação 0)	-	3 
		Hambúrgueres (grau de preparação 0)	1,5 - 3 cm	5  4 
		Assado-Cozinhar lentamente (nível cozedura 0) *	0,6 - 2 kg **	3 
	Porco assado	Assado	0,6 - 2,5 kg **	3 
		Perna de frango*	0,5 - 2,0 kg **	3 
		Salsichas	1,5 - 4 cm	5  4 
	Vitela assada *		0,6 - 2,5 kg **	3 
	Borrego assado	Assado (nível cozedura 0) *	0,6 - 2,5 kg **	2 
		Perna (nível de cozedura 0) *	0,5 - 2,0 kg **	2 
	Frango assado	Inteiro	0,6 - 3 kg **	2 
Peças inteiras recheadas *		0,6 - 3 kg **	2 	
Filetes & Peito		1 - 5 cm	5  4 	
Peru inteiro assado	Inteiro *	0,6 - 3 kg **	2 	
	Peças inteiras recheadas *	0,6 - 3 kg **	2 	
Kebab		1 grelha	5  4 	

CATEGORIAS DE ALIMENTOS		QUANTIDADE	VIRAR (DO TEMPO DE COZEDURA)	NÍVEL E ACESSÓRIOS	
PEIXE	Filetes	0,5 - 3 cm	-	3  2 	
	Filetes cong.	0,5 - 3 cm	-	3  2 	
LEGUMES	Legumes assados	Batatas	0,5 - 1,5 kg	-	3 
		Legumes recheados	0,1 - 0,5 kg cada	-	3 
		Legumes assados	0,5 - 1,5 kg	-	3 
	Legumes gratinados	Batatas	1 tabuleiro	-	3 
		Tomates	1 tabuleiro	-	3 
		Pimentos	1 tabuleiro	-	3 
		Brócolos	1 tabuleiro	-	3 
		Couve-flor	1 tabuleiro	-	3 
Outros	1 tabuleiro	-	3 		
BOLOS E PASTÉIS	Bolos de fermentação	Pão-de-ló	0,5 - 1,2 kg	-	3 
		Cookies	0,2 - 0,6 kg	-	3 
	Pastéis e tartes recheadas	Massa "choux"	1 tabuleiro	-	3 
		Torta	0,4 - 1,6 kg	-	3 
		Strudel	0,4 - 1,6 kg	-	3 
		Tarte rec. fruta	0,5 - 2 kg	-	3 
BOLOS SALGADOS	-	0,8 - 1,2 kg	-	2 	
PÃO	Rolls	60 - 150 g cada	-	3 	
	Pão de forma	400 - 600g cada	-	2 	
	Pão grande	0,5 - 2,0 kg	-	2 	
	Baguetes	200 - 300g cada	-	3 	
PIZZA	Fina	redondo - tabuleiro	-	2 	
	Grossa	redondo - tabuleiro	-	2 	
	Congelada				2 
			1 - 4 fatias	-	4  2  5  3  1  5  3  2  1 

\* Disponível apenas em alguns modelos. Função disponível apenas em combinação com o termómetro de carne.

\*\* Quantidade sugerida.

ACESSÓRIOS



Grelha



Tabuleiro de assar ou  
forma de bolos  
na grelha



Tabuleiro coletor/  
Tabuleiro de pastelaria ou  
tabuleiro para assar na grelha



Tabuleiro coletor  
/ tabuleiro para  
bolos



































Tabuleiro coletor com  
500 ml de água



Termómetro de carne  
(se fornecido)

# TABELA DE COZEDURA

RECEITA	FUNÇÃO	PRÉ-AQUECIMENTO	TEMPERATURA (°C)	DURAÇÃO (MIN.)	TABULEIRO E ACESSÓRIOS
Bolos levedados / Pães-de-ló		Sim	170	30 - 50	2
		Sim	160	30 - 50	2
		Sim	160	30 - 50	4 1
Bolos recheados (cheesecake, strudel, tarte de maçã)		Sim	160 - 200	30 - 85	3
		Sim	160 - 200	35 - 90	4 1
Cookies / Biscoitos		Sim	150	20 - 40	3
		Sim	140	30 - 50	4
		Sim	140	30 - 50	4 1
		Sim	135	40 - 60	5 3 1
Bolos pequenos / queques		Sim	170	20 - 40	3
		Sim	150	30 - 50	4
		Sim	150	30 - 50	4 1
		Sim	150	40 - 60	5 3 1
Massa choux		Sim	180 - 200	30 - 40	3
		Sim	180 - 190	35 - 45	4 1
		Sim	180 - 190	35 - 45 *	5 3 1
Merengues		Sim	90	110 - 150	3
		Sim	90	130 - 150	4 1
		Sim	90	140 - 160 *	5 3 1
Pizza / Pão / Focaccia		Sim	190 - 250	15 - 50	2
		Sim	190 - 230	20 - 50	4 1
Pizza (massa fina, massa grossa, focaccia)		Sim	220 - 240	25 - 50 *	5 3 1
Pizza congelada		Sim	250	10 - 15	3
		Sim	250	10 - 20	4 1
		Sim	220 - 240	15 - 30	5 3 1
Tartas salgadas (tarte de legumes, quiche)		Sim	180 - 190	45 - 55	3
		Sim	180 - 190	45 - 60	4 1
		Sim	180 - 190	45 - 70 *	5 3 1
Vols-au-vent / Salgadinhos de massa folhada		Sim	190 - 200	20 - 30	3
		Sim	180 - 190	20 - 40	4 1
		Sim	180 - 190	20 - 40 *	5 3 1
Lasanha / Flans / Massa cozida / Cannelloni		Sim	190 - 200	45 - 65	3
Borrego / Vitela / Vaca / Lombo 1 kg		Sim	190 - 200	80 - 110	3

FUNÇÕES



Convencional



Ar forçado



Coz. convecção



Grill



Turbo Grill



MaxiCooking



































































Cook 4



Ar Forçado Eco



RECEITA	FUNÇÃO	PRÉ-AQUECIMENTO	TEMPERATURA (°C)	DURAÇÃO (MIN.)	TABULEIRO E ACESSÓRIOS
Porco assado estaladiço 2 kg		-	170	110 - 150	
Frango / Coelho / Pato 1 kg		Sim	200 - 230	50 - 100	
Peru / ganso 3 kg		Sim	190 - 200	80 - 130	
Peixe no forno / em papelote (filetes, inteiro)		Sim	180 - 200	40 - 60	
Legumes recheados (tomates, curgetes, beringelas)		Sim	180 - 200	50 - 60	
Pão tostado		-	3 (alto)	3 - 6	
Filetes / postas de peixe		-	2 (médio)	20 - 30 **	 
Salsichas / Espetadas / Costeletas / Hambúrgueres		-	2 - 3 (médio-alto)	15 - 30 **	 
Frango assado 1-1,3 kg		-	2 (médio)	55 - 70 ***	 
Perna de borrego / pernis		-	2 (médio)	60 - 90 ***	
Batatas assadas		-	2 (médio)	35 - 55 ***	
Gratinado de legumes		-	3 (alto)	10 - 25	
Cookies	 Cookies	Sim	135	50 - 70	   
Tarte	 Tarte	Sim	170	50 - 70	   
Pizza redonda	 Pizza	Sim	210	40 - 60	   
Refeição completa: Tarte de frutos (nível 5) / lasanha (nível 3) / carne (nível 1)	 Menu	Sim	190	40 - 120 *	  
Refeição completa: Tarte de frutas (nível 5) / legumes assados (nível 4) / lasanha (nível 2) / fatias de carne (nível 1)	 Menu	Sim	190	40 - 120 *	   
Lasanha e Carne		Sim	200	50 - 100 *	 
Carne e Batatas		Sim	200	45 - 100 *	 
Peixe e legumes		Sim	180	30 - 50 *	 
Peças de carne recheadas		-	200	80 - 120 *	
Cortes de carne (coelho, frango, borrego)		-	200	50 - 100 *	

\* Período de tempo estimado: Os alimentos podem ser retirados do forno quando o desejar, dependendo da preferência de cada um.

\*\* Vire o alimento a meio da cozedura.

\*\*\* Vire o alimento quando atingir dois terços do tempo de cozedura (se necessário).

#### COMO EFETUAR A LEITURA DA TABELA DE COZEDURA

A tabela indica a função, os acessórios e o nível mais adequados para utilizar na confeção dos diferentes tipos de alimentos. Os tempos de cozedura começam a partir do momento em que o alimento é colocado no forno, excluindo o pré-aquecimento (sempre que necessário). As temperaturas e os tempos de cozedura são aproximados e dependem da quantidade de alimento e do tipo de acessório utilizado. Comece por utilizar as definições mais baixas recomendadas e, se o alimento não ficar bem cozinhado, mude para definições mais elevadas. Utilize os acessórios fornecidos e, de preferência, formas para bolos e tabuleiros para assar metálicos e de cor escura. Também poderá utilizar recipientes e acessórios em cerâmica ou pirex, mas tenha em conta que os tempos de cozedura serão ligeiramente superiores.

#### ACESSÓRIOS



Grelha



Tabuleiro de assar ou forma de bolos na grelha



Tabuleiro coletor / Tabuleiro de pastelaria ou tabuleiro para assar na grelha



Tabuleiro coletor / tabuleiro para bolos



Tabuleiro coletor com 500 ml de água



Termómetro de carne (se fornecido)

## LIMPEZA E MANUTENÇÃO

Assegure-se de que o forno arrefece antes de executar qualquer operação de manutenção ou limpeza.

Não utilize aparelhos de limpeza a vapor.

Não utilize palha de aço, esfregões abrasivos ou produtos de limpeza abrasivos/corrosivos, uma vez que estes podem danificar as superfícies do aparelho.

Use luvas de proteção.

O forno tem de ser desligado da rede elétrica antes da realização de qualquer tipo de trabalho de manutenção.

### SUPERFÍCIES EXTERIORES

- Limpe as superfícies com um pano de microfibra húmido.  
Se estiverem muito sujas, acrescente alguns pingos de detergente com PH neutro. Termine a limpeza com um pano seco.
- Não utilize detergentes corrosivos ou abrasivos. Se algum destes produtos entrar inadvertidamente em contacto com as superfícies do aparelho, limpe imediatamente com um pano de microfibra húmido.

### SUPERFÍCIES INTERIORES

- Após cada utilização, deixe que o forno arrefeça e limpe-o, de preferência enquanto estiver morno, para remover eventuais depósitos ou manchas causados por resíduos de alimentos. Para secar qualquer condensação que se tenha formado devido à cozedura de alimentos com elevado teor de água, deixe o forno arrefecer completamente e limpe-o com um pano ou uma esponja.

- Limpe o vidro da porta com um detergente líquido adequado.
- A porta do forno pode ser removida para facilitar a limpeza.

### ACESSÓRIOS

Após a utilização, coloque os acessórios numa solução líquida de limpeza, pegando nos mesmos com luvas de forno, caso ainda estejam quentes. Os resíduos de alimentos podem ser retirados com uma esponja ou escova de limpeza.

### REMOVER E REPOR A PORTA

1. **Para remover a porta**, abra-a totalmente e baixe as linguetas até ficarem na posição de desbloqueio.

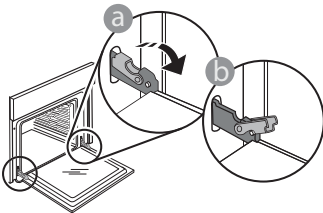

2. Feche a porta tanto quanto possível. Segure firmemente a porta com ambas as mãos – não a segure pela pega.  
Remova, simplesmente, a porta, continuando a fechá-la enquanto a puxa, simultaneamente, para cima, até se libertar do respetivo suporte. Coloque a porta de parte, apoiando-a sobre uma superfície suave.

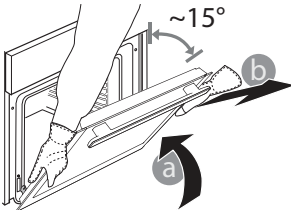

3. **Reponha a porta**, deslocando-a na direção do forno e alinhando os ganchos das dobradiças com os respetivos suportes, fixando a parte superior aos suportes.
4. Baixe a porta e, em seguida, abra-a totalmente. Baixe as linguetas para a respetiva posição original: Assegure-se de que as baixe totalmente.

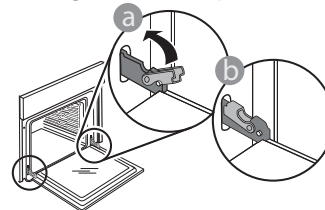

Aplique uma pressão suave, para se assegurar de que as linguetas estão na posição correta.

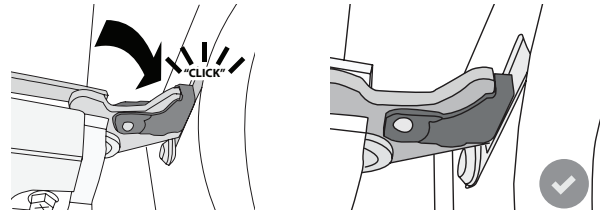

5. Tente fechar a porta e assegure-se de que está alinhada com o painel de controlo. Se não estiver, repita os procedimentos acima: A porta poderá ficar danificada se não funcionar corretamente.

## SUBSTITUIR A LÂMPADA

1. Desligue o forno da corrente elétrica.
2. Desaperte a cobertura da lâmpada, substitua a lâmpada e aperte novamente a cobertura da mesma.
3. Ligue o forno novamente à corrente elétrica.

Nota: Use apenas lâmpadas de halogéneo de 20-40 W/230 ~ V do tipo G9, T300 °C. A lâmpada utilizada no produto foi especificamente concebida para eletrodomésticos e não é adequada para a iluminação geral de divisões da casa (Regulamento CE 244/2009). As lâmpadas estão disponíveis no nosso Serviço Pós-Venda.

- Se utilizar lâmpadas de halogéneo, não as manuseie diretamente com as mãos, uma vez que as suas impressões digitais podem provocar danos. Não utilize o forno até que a cobertura da lâmpada tenha sido repostada.

## RESOLUÇÃO DE PROBLEMAS

PROBLEMA	CAUSA POSSÍVEL	SOLUÇÃO
O forno não está a funcionar.	Corte de energia. Desativação da rede elétrica.	Verifique se existe energia elétrica proveniente da rede e se o forno está ligado à tomada elétrica. Desligue e volte a ligar o forno, para verificar se o problema ficou resolvido.
O visor apresenta a letra "F", seguida de um número ou uma letra.	Falha do forno.	Desligue e volte a ligar o forno, para verificar se o problema ficou resolvido. Tente selecionar a opção "REP. DE FÁBRICA", selecionável a partir das "DEFINIÇÕES". Contacte o seu Serviço Técnico de Pós-Venda mais próximo e indique o número que acompanha a letra "F".
O forno não aquece.	Quando o modo Demo está ligado, todos os comandos estão ativos e os menus disponíveis mas o forno não aquece. A palavra "DEMO" surge no visor a cada 60 segundos.	Aceda a "DEMO" a partir de "DEFINIÇÃO" e selecione "Off" (Desligado).
A luz desliga-se.	O modo "ECO" está "On" (Ligado).	Aceda a "ECO" a partir de "DEFINIÇÃO" e selecione "Off" (Desligado).
A porta não abre.	Ciclo de limpeza em curso.	Aguarde que a função termine e que o forno arrefeça.
Houve uma falha de eletricidade.	Regulação da potência incorreta.	Certifique-se de que a sua rede doméstica possui uma potência de, pelo menos, 3 kW. Se não for o caso, reduza a potência para 13 amperes. Aceda à função "POTÊNCIA" a partir das "DEFINIÇÕES" e selecione a opção "BAIXO".



Pode transferir as instruções de segurança, o manual do utilizador, a ficha do produto e os dados energéticos:

- Visitando o nosso website [docs.whirlpool.eu](http://docs.whirlpool.eu)
- Utilizando o código QR
- Em alternativa, **contacte o nosso Serviço Pós-venda** (através do número de telefone contido no livrete da garantia). Ao contactar o nosso Serviço Pós-Venda, indique os códigos fornecidos na placa de identificação do seu produto.

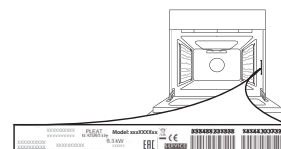



**GRACIAS POR ADQUIRIR UN PRODUCTO WHIRLPOOL**

Para recibir una asistencia más completa, registre su producto en [www.whirlpool.eu/register](http://www.whirlpool.eu/register)



**Antes de usar el aparato, lea atentamente las Instrucciones de seguridad.**

## DESCRIPCIÓN DEL PRODUCTO

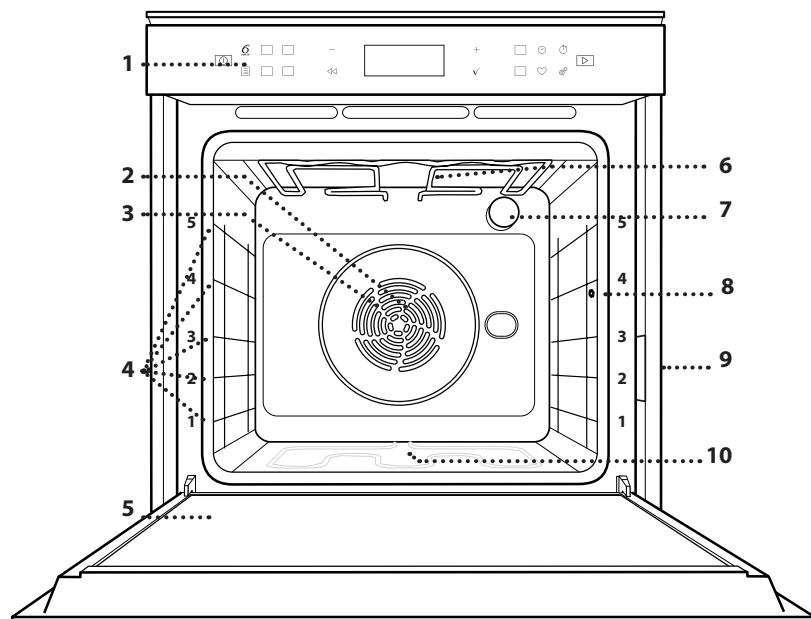

1. Panel de control
2. Ventilador
3. Resistencia circular (no visible)
4. Guías para estantes (el nivel está indicado en la parte frontal del horno)
5. Puerta
6. Resistencia superior/grill
7. Lámpara
8. Punto de inserción de la sonda para carne
9. Placa de características (no debe retirarse)
10. Resistencia inferior (no visible)

## DESCRIPCIÓN DEL PANEL DE CONTROL

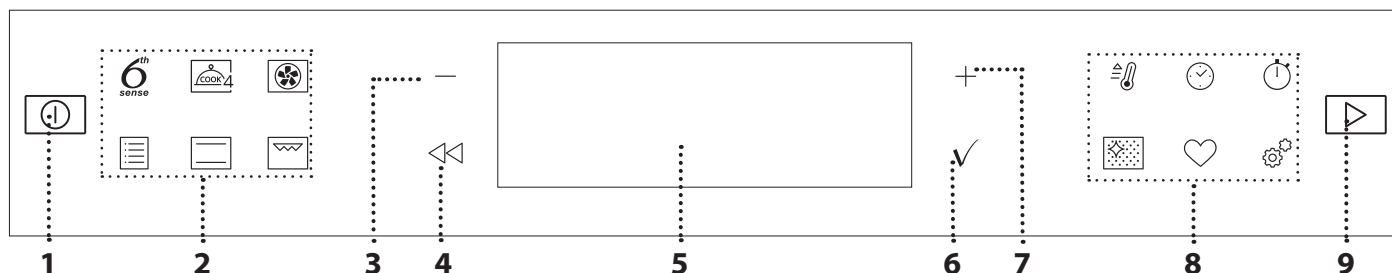

### 1. ON / OFF

Sirve para encender o apagar el horno, y para detener una función activa.

### 2. ACCESO DIRECTO A LAS FUNCIONES

Sirve para obtener acceso rápido a las funciones y al menú.

### 3. BOTÓN DE NAVEGACIÓN MENOS

Sirve para desplazarse por un menú y reducir los ajustes o valores de una función.

### 4. ATRÁS

Sirve para volver a la pantalla anterior. Durante la cocción, permite cambiar los ajustes.

### 5. PANTALLA

### 6. CONFIRMAR

Sirve para confirmar una función o un valor seleccionados.

### 7. BOTÓN DE NAVEGACIÓN MÁS

Sirve para desplazarse por un menú e incrementar los ajustes o valores de una función.

### 8. ACCESO DIRECTO A LAS OPCIONES/FUNCIONES

Sirve para obtener acceso rápido a las funciones, a la duración, a los ajustes y a los favoritos.

### 9. INICIO

Para iniciar una función utilizando la configuración específica o básica.

# ACCESORIOS

## REJILLA

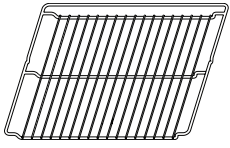

Para cocinar alimentos o como soporte de cazuelas, moldes de tartas y otros recipientes de cocción aptos para horno.

## GRASERA

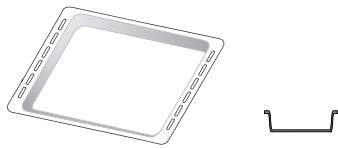

Para utilizar como bandeja de horno para cocinar carne, pescado, verduras, focaccia, etc. o para recoger los jugos de la cocción debajo de la rejilla.

## BANDEJA PASTELERA

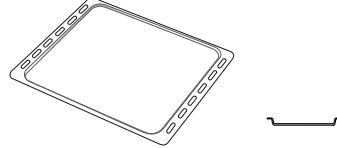

Se utiliza para pan y pasteles, pero también para asados, pescado en papillote, etc.

## GUÍAS DESLIZANTES\*

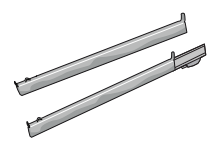

Para facilitar la inserción y extracción de accesorios.

## SONDA PARA CARNE\*

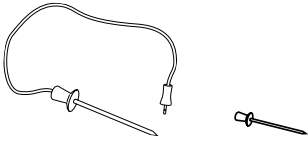

Para medir la temperatura del centro de los alimentos durante la cocción.

\* Disponible en determinados modelos solamente

El número y el tipo de accesorio puede variar dependiendo del modelo comprado.

Se pueden adquirir otros accesorios por separado en el Servicio Postventa.

## INTRODUCCIÓN DE LA REJILLA Y OTROS ACCESORIOS

Introduzca la rejilla horizontalmente deslizándola a través de las guías y asegúrese de que el lado con el borde en relieve queda mirando hacia arriba.

Otros accesorios, como la grasera y la bandeja pastelera, se introducen horizontalmente igual que la rejilla.

## CÓMO EXTRAER Y VOLVER A COLOCAR LAS GUÍAS PARA ESTANTES

- Para extraer las guías para estantes, levántelas y saque la parte inferior con cuidado de su alojamiento: Ahora puede extraer las guías.
- Para volver a colocar las guías para estantes, primero colóquelas en su alojamiento superior. Manteniéndolas en alto, deslícelas en el compartimento de cocción, y luego bájelas hasta colocarlas en el alojamiento inferior.

## MONTAJE DE LAS GUÍAS DESLIZANTES (SI PROCEDE)

(SI PROCEDE)

Extraiga las guías para los estantes del horno y quite el plástico de protección de las guías deslizantes.

Fije el cierre superior de la corredera a la guía para los estantes y deslícela hasta el tope. Baje el otro clip a su posición.

Para fijar la guía, empuje la parte inferior del cierre contra la guía para estantes. Asegúrese de que las guías se pueden mover libremente. Repita estos pasos en la otra guía para estantes del mismo nivel.

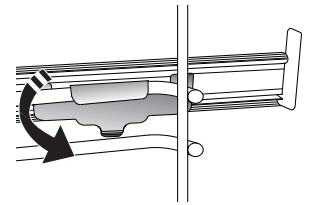
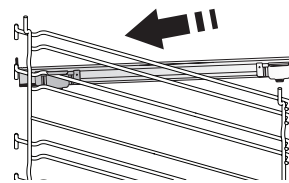

Nota: Las guías deslizantes se pueden montar en cualquier nivel.

## USO DE LA SONDA PARA CARNE (SI LA HAY)

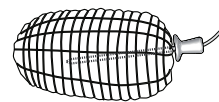

Introduzca la sonda de alimentos dentro de la carne, evitando huesos y zonas de grasa. En las aves, introduzca la sonda longitudinalmente en el centro de la pechuga, evitando zonas huecas.

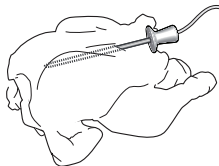

Coloque el alimento en el horno y conecte el enchufe introduciéndolo en la conexión prevista en la parte derecha del compartimento del horno.



## FUNCIONES



### 6<sup>th</sup> SENSE

Permiten una cocción completamente automática para todo tipo de platos (Lasaña, Carne, Pescado, Verduras, Tartas y pasteles dulces, Tartas saladas, Pan o Pizza).

Para sacar el máximo rendimiento a esta función, siga las indicaciones de la tabla de cocción correspondiente.



### COOK 4

Para cocinar diferentes tipos de alimentos que requieran la misma temperatura de cocción en cuatro estantes distintos al mismo tiempo. Esta función puede utilizarse para hornear galletas, tartas, pizzas redondas (también congeladas) y para preparar un menú completo. Siga la tabla de cocción para obtener los mejores resultados.



### AIRE FORZADO

Para cocinar diferentes tipos de alimentos que requieran la misma temperatura de cocción en diferentes estantes (máximo tres) al mismo tiempo. Esta función puede utilizarse para cocinar diferentes alimentos sin que se mezclen los olores.



### TRADICIONALES

#### • HORNO CONVECC.

Para cocinar carne y hornear tartas con relleno en un único estante.

#### • TURBO GRILL

Para asar grandes piezas de carne (pierna de cordero, roast beef, pollo). Le recomendamos utilizar la grasera para recoger los jugos de la cocción: Coloque el recipiente en cualquiera de los niveles debajo de la rejilla y añada 500 ml de agua potable.

#### • HORNEAR CONG.

Esta función selecciona automáticamente la temperatura y el modo de cocción ideal para 5 tipos diferentes de alimentos congelados preparados. No es necesario precalentar el horno.

#### • FUNCIONES ESPECIALES

##### » MAXI COOKING

Esta función selecciona automáticamente la mejor forma de cocción y temperatura para cocinar una gran cantidad de carne (más de 2,5 kg). Se recomienda dar la vuelta a la carne durante la cocción para obtener un gratinado homogéneo por ambos lados. Se recomienda untar la carne periódicamente con su propio jugo para que no se seque en exceso.

##### » FERMENTAR MASA

Para optimizar la fermentación de masas dulces o saladas. Para garantizar la calidad del leudado, no active la función si el horno está caliente después de un ciclo de cocción.

##### » DESCONGELANDO

Para acelerar la descongelación de los alimentos. Se recomienda colocar los alimentos en el estante

central. Además, se recomienda dejar los alimentos en su envase para evitar que se sequen por fuera.

##### » MANTENER CALIENTE

Para mantener calientes y crujientes los alimentos recién cocinados.

##### » ECO AIRE FORZADO

Para cocinar piezas de carne asadas con relleno y filetes de carne en un solo estante. Para evitar que los alimentos se resequen, el aire circula de manera suave e intermitente. Cuando se utiliza esta función ECO, la luz permanece apagada durante la cocción. Para utilizar el ciclo ECO y optimizar el consumo de energía, la puerta del horno no se debe abrir hasta que termine la cocción.



### CONVENCIONAL

Para cocinar cualquier tipo de alimento en un estante.



### GRILL

Para asar filetes, pinchos morunos y salchichas, cocinar verduras gratinadas o tostar pan. Cuando ase carne, le recomendamos colocar la grasera debajo para recoger los jugos de la cocción: Coloque la bandeja en cualquiera de los niveles debajo de la rejilla y añada 500 ml de agua potable.



### PRECALENTAR RÁPIDO

Para precalentar el horno rápidamente.



### TEMPORIZADORES

Para editar los valores de tiempo de la función.



### TEMPORIZADOR

Para controlar el tiempo sin activar una función.



### LIMPIEZA AUTOMÁTICA DEL HORNO - LIMP. PIRO

Para eliminar las salpicaduras de cocción, utilice un ciclo a muy alta temperatura. Es posible elegir entre dos ciclos de limpieza automática: Un ciclo completo (Limp. Piro) y un ciclo reducido (Limp. Piro Eco). Le recomendamos utilizar el ciclo más rápido de forma periódica y utilizar el ciclo completo solamente cuando el horno esté muy sucio.



### FAVORITOS

Para recuperar la lista de las 10 funciones favoritas.



### AJUSTES

Para ajustar los ajustes del horno.

Cuando el modo «ECO» está activado, se reduce el brillo de la pantalla para ahorrar energía y la luz se apaga al cabo de 1 minuto. Se volverá a activar automáticamente al pulsar cualquier botón.

Cuando «DEMO» está establecido en «On», todos los mandos están activos y los menús disponibles, pero el horno no se calienta. Para desactivar este modo, acceda a «DEMO» desde el menú de «AJUSTES» y seleccione «Off».

Si selecciona «RES. AJUSTE FAB.», el producto se apagará y después volverá a su puesta en marcha por primera vez. Se borrarán todos los ajustes.

# PRIMER USO

## 1. SELECCIONE EL IDIOMA

La primera vez que encienda el aparato, tendrá que seleccionar el idioma y ajustar la hora: La pantalla mostrará «English».



Pulse + o – para desplazarse por la lista de idiomas disponibles y seleccione el idioma que desee. Pulse ✓ para confirmar su selección.

Nota: El idioma puede cambiarse posteriormente seleccionando «IDIOMA» en el menú de «AJUSTES», que está disponible al pulsar .

## 2. CONFIGURACIÓN DEL CONSUMO DE POTENCIA

El horno está programado para consumir un nivel de potencia eléctrica compatible con el de una red doméstica que tenga una potencia superior a 3 kW (16): Si su hogar tiene menos potencia, deberá reducir este valor (13).



Pulse + o – para seleccionar 16 «Alto» o 13 «Bajo» y pulse ✓ para confirmar.

# USO DIARIO

## 1. SELECCIONAR UNA FUNCIÓN

Pulse  para encender el horno: la pantalla mostrará la última función principal en curso o el menú principal.

Puede seleccionar las funciones pulsando el icono de una de las funciones principales o desplazándose por el menú: Para seleccionar un elemento del menú (la pantalla mostrará el primer elemento disponible), pulse + o – para seleccionar el elemento deseado y después pulse ✓ para confirmar.

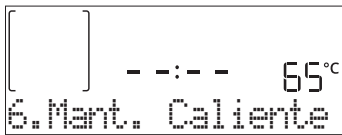

## 2. AJUSTAR LA FUNCIÓN

Cuando haya seleccionado la función que desee, puede cambiar la configuración correspondiente. En la pantalla aparecerá la configuración que se puede cambiar por orden. Pulsando  puede volver a cambiar el ajuste anterior.

### TEMPERATURA / NIVEL DEL GRILL



## 3. CÓMO CONFIGURAR LA HORA

Después de seleccionar la potencia, tendrá que configurar la hora actual: En la pantalla parpadean las dos cifras de la hora.



Pulse + o – para establecer la hora actual y pulse ✓ : En la pantalla parpadean las dos cifras de los minutos. Pulse + o – para ajustar los minutos y pulse ✓ para confirmar.

Nota: Después de un corte de suministro prolongado, es posible que tenga que volver a configurar la hora. Seleccione «RELOJ» en el menú de «AJUSTES», que está disponible al pulsar .

## 4. CALENTAR EL HORNO

Un horno nuevo puede liberar olores que se han quedado impregnados durante la fabricación: es completamente normal. Antes de empezar a cocinar, le recomendamos calentar el horno en vacío para eliminar cualquier olor. Quite todos los cartones de protección o el film transparente del horno y saque todos los accesorios de su interior. Caliente el horno a 200 °C aproximadamente durante una hora, preferiblemente utilizando la función con circulación del aire (p. ej. «Aire forzado» u «Horno de Convección»).

Nota: Es aconsejable ventilar la habitación después de usar el aparato por primera vez.



Cuando el valor parpadee en la pantalla, pulse + o – para cambiarlo, después pulse ✓ para confirmar y siga con los ajustes siguientes (si es posible).

Del mismo modo puede ajustar el nivel del grill: Existen tres niveles de potencia para el grill: 3 (alta), 2 (media), 1 (baja).

Nota: Una vez activada la función, se puede cambiar la temperatura o el nivel del grill con + o – .

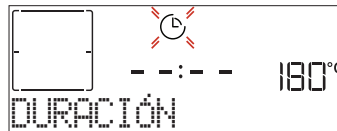
### DURACIÓN



Cuando el icono  parpadee en la pantalla, pulse + o – para ajustar el tiempo de cocción necesario y luego pulse ✓ para confirmar. Si quiere cocinar de forma manual no es necesario configurar el tiempo de cocción (sin tiempo programado): Pulse ✓ o  para confirmar e iniciar la función. Si selecciona este modo no puede programar un inicio diferido.

Nota: Pulse  para ajustar el tiempo de cocción establecido: pulse + o – para cambiarlo y pulse ✓ para confirmar.

### TIEMPO FINAL (INICIO DIFERIDO)

En muchas funciones, una vez configurado el tiempo de cocción, podrá retrasar el inicio de la función programando el tiempo final. La pantalla muestra el tiempo final mientras el icono  parpadea.



Pulse  $+$  o  $-$  para configurar la hora a la que quiere que termine la cocción y pulse  $\checkmark$  para confirmar y activar la función. Coloque los alimentos en el horno y cierre la puerta: Esta función se iniciará automáticamente cuando haya transcurrido el periodo de tiempo calculado para que la cocción termine a la hora programada.

Nota: Programar una cocción con inicio diferido deshabilitará la fase de precalentamiento del horno: el horno alcanzará la temperatura deseada de forma gradual, con lo que los tiempos de cocción serán ligeramente mayores que los de la tabla de cocción. Durante el tiempo de espera, puede pulsar  $+$  o  $-$  para cambiar el tiempo final programado o pulsar  $\ll$  para cambiar otros ajustes. Si pulsa  para ver la información, puede cambiar entre el tiempo final y la duración.

### 6<sup>th</sup> SENSE

Estas funciones seleccionan de forma automática el mejor modo de cocción y la mejor la temperatura y duración para cocinar, asar u hornear todos los platos disponibles. Cuando sea necesario, indique simplemente la característica del alimento para obtener un resultado óptimo.

#### PESO / ALTURA (NIVEL DE BANDEJAS REDONDAS)



Para configurar la función correctamente, siga las indicaciones en la pantalla cuando se muestren y pulse  $+$  o  $-$  para establecer el valor deseado, después pulse  $\checkmark$  para confirmar.

#### NIVEL COCCIÓN / GRATINAR

En algunas funciones 6<sup>th</sup> Sense se puede ajustar el grado de cocción.

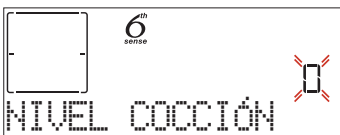

Cuando se indique, pulse  $+$  o  $-$  para seleccionar el nivel deseado entre poco hecho (-1) y muy hecho (+1). Pulse  $\checkmark$  o  $\triangleright$  para confirmar e iniciar la función.

Del mismo modo, cuando sea posible, en algunas funciones 6<sup>th</sup> Sense puede ajustarse el nivel de gratinado entre bajo (-1) y alto (+1).

### 3. INICIO DE LA FUNCIÓN

En cualquier momento, si los valores predeterminados son los deseados o una vez aplicados los ajustes que desea, pulse  $\triangleright$  para activar la función.

Durante la fase de inicio diferido, pulse  $\triangleright$  para omitir esta fase e iniciar la función inmediatamente.

Nota: Una vez seleccionada una función, la pantalla recomendará el nivel más adecuado para cada función.

En cualquier momento puede detener una función activa pulsando .

Si el horno está caliente y la función requiere una temperatura máxima específica, se mostrará un mensaje en la pantalla. Pulse  $\ll$  para volver a la pantalla anterior y seleccionar una función distinta o espere a que se enfríe por completo.

### 4. PRECALENTANDO

Algunas funciones incluyen una fase de precalentamiento de horno: Una vez iniciada la función, la pantalla indica que se ha activado la fase de precalentado.

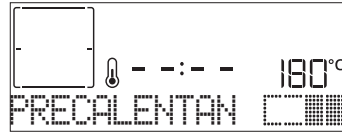

Cuando el precalentamiento haya terminado, sonará una señal acústica y la pantalla indicará que el horno ha alcanzado la temperatura establecida y le pedirá «AÑADIR ALIMENTO». En ese momento, abra la puerta, introduzca los alimentos en el horno y cierre para iniciar la cocción pulsando  $\checkmark$  o  $\triangleright$ .

Nota: Colocar los alimentos en el horno antes de que haya finalizado el precalentamiento puede tener efectos adversos en el resultado final de la cocción. Abrir la puerta durante la fase de precalentamiento pausará el proceso.

El tiempo de cocción no incluye la fase de precalentamiento. La temperatura deseada se puede cambiar en cualquier momento utilizando  $+$  o  $-$ .

### 5. INTERRUPCIÓN DE LA COCCIÓN / DAR LA VUELTA O COMPROBAR EL ESTADO DE LA COMIDA

Al abrir la puerta, la cocción se interrumpirá temporalmente y las resistencias se desactivarán.

Para reanudar la cocción, cierre la puerta.

Algunas funciones 6<sup>th</sup> Sense requerirán que dé la vuelta a la comida durante la cocción.



Se emitirá una señal acústica y la pantalla indicará las acciones que deberá realizar. Abra la puerta, realice la acción indicada por la pantalla y cierre la puerta, después pulse  $\triangleright$  para seguir cocinando.

Del mismo modo, cuando haya pasado el 10 % del tiempo de la cocción el horno le solicitará que compruebe el estado de la comida.

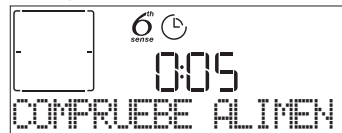

Se emitirá una señal acústica y la pantalla indicará las acciones que deberá realizar. Compruebe la comida, cierre la puerta y pulse  $\triangleright$  o  $\checkmark$  para seguir cocinando.

Nota: Pulse  $\triangleright$  para omitir estas acciones. Por otro lado, si no se realiza ninguna acción pasado un tiempo, el horno continuará con la cocción.

## 6. FINAL DE COCCIÓN

Sonará una señal acústica y la pantalla indicará que la cocción ha terminado.

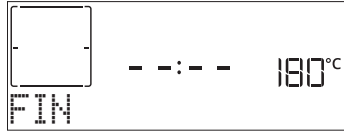

Pulse para seguir cocinando en modo manual (sin tiempo programado) o pulse para alargar el tiempo de cocción configurando una nueva duración. En ambos casos, los parámetros de cocción se mantendrán.

### GRATINAR

Algunas funciones del horno le permiten gratinar la superficie de los alimentos activando el grill una vez finalizada la cocción.

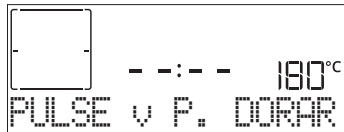

Cuando la pantalla lo indique, si lo desea pulse para iniciar un ciclo de gratinado de cinco minutos. Puede detener la función en cualquier momento pulsando para apagar el horno.

### FAVORITOS

Una vez completada la cocción, la pantalla le indicará que guarde la función asignándole un número del 1 al 10 en su lista de favoritos.

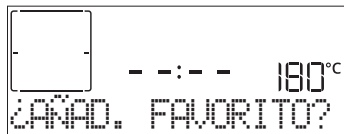

Si desea guardar una función como favorita y memorizar los ajustes actuales para el futuro, mantenga pulsado , si desea ignorar la solicitud, pulse .

Una vez pulsado , pulse o para seleccionar el número, después pulse para confirmar.

Nota: Si la memoria está llena o si el número seleccionado ya está ocupado, el horno le solicitará la confirmación para sobrescribir la función anterior.

Para activar las últimas funciones guardadas, pulse : La pantalla mostrará una lista de sus funciones favoritas.



Pulse o para seleccionar la función, confirme pulsando , y después pulse para activarla.

### LIMPIEZA AUTOMÁTICA – LIMP. PIRO

**No toque el horno durante el ciclo de limpieza pirolítica. Mantenga a los niños y a los animales alejados del horno durante y después (hasta que la habitación haya terminado de ventilarse) del ciclo de limpieza pirolítica.**

Retire todos los accesorios del horno antes de activar esta función (incluidas las guías de los estantes). Si va a instalar el horno debajo de una encimera, asegúrese de que todos los quemadores o placas eléctricas estén

apagados durante el ciclo de autolimpieza. Para obtener unos resultados de limpieza óptimos, elimine el exceso de residuos del interior del aparato y limpie el cristal interior de la puerta antes de usar la función Limp. Piro. Le recomendamos activar la función Limp. Piro solamente si el aparato está muy sucio o desprende mal olor durante la cocción.

Pulse para mostrar «Limp. Piro» en la pantalla.



Pulse o para seleccionar el ciclo deseado y después pulse para confirmar. Una vez seleccionado un ciclo, si lo desea pulse o para ajustar el tiempo final (inicio diferido) y después pulse para confirmar.

Limpie la puerta y retire todos los accesorios según se indique, después cierre la puerta y pulse cuando termine: el horno iniciará el ciclo de autolimpieza y la puerta se bloquea automáticamente: en la pantalla aparece un mensaje de advertencia junto con una cuenta atrás que indica el estado del ciclo en curso.

Una vez terminado el ciclo, la puerta permanece bloqueada hasta que la temperatura en el interior del horno haya vuelto a un nivel seguro.

### TEMPORIZADOR

Cuando el horno está apagado, la pantalla puede utilizarse como temporizador. Para activar esta función, asegúrese de que el horno esté apagado y pulse o : El icono parpadeará en la pantalla.

Pulse o para seleccionar el tiempo que necesita y pulse para activar el temporizador.



Una vez que haya finalizado la cuenta atrás del tiempo seleccionado sonará una señal acústica y la pantalla lo indicará.

Nota: El temporizador no activa ninguno de los ciclos de cocción. Pulse o para cambiar el tiempo ajustado en el temporizador.

Cuando se haya activado el temporizador, también podrá seleccionar y activar una función.

Pulse para encender el horno y después seleccione la función que desee.

Una vez iniciada la función, el temporizador seguirá la cuenta atrás de forma independiente sin interferir en la función.

Nota: Durante esta fase no podrá ver el temporizador (solamente se mostrará el icono ), que continuará con la cuenta atrás en segundo plano. Si desea recuperar la pantalla del temporizador, pulse para detener la función activa.



**. BLOQUEO DE TECLAS**

Para bloquear las teclas, mantenga pulsado << durante al menos cinco segundos. Para desbloquearlo, siga el mismo proceso.



Nota: Esta función también puede activarse durante la cocción. Por motivos de seguridad, puede apagar el horno en cualquier momento pulsando el botón [OFF].

**. USO DE LA SONDA DE CARNE (SI LA HAY)**

La sonda para carne permite medir la temperatura interior de la carne durante la cocción para asegurarse de que esta alcanza la temperatura óptima. La temperatura del horno varía según la función que haya seleccionado, pero la cocción siempre se programa para terminar una vez alcanzada la temperatura especificada. Una vez introducida la sonda, se activará una señal acústica y en la pantalla se mostrará «Sonda conectada».



Seleccione la función que desea entre las funciones

compatibles (Convencional, Aire forzado, Horno convecc., Turbo grill, Eco aire forzado, Maxi Cooking y 6<sup>th</sup> Sense): La pantalla indica que debe seleccionar la temperatura deseada de la sonda: Pulse + o - para configurarla y pulse ✓ para ajustar los siguientes parámetros de cocción.

Como la cocción está programada para terminar una vez alcanzada la temperatura deseada, no es posible configurar el tiempo de cocción o establecer una hora específica para que acabe la cocción. La luz permanecerá encendida hasta que se extraiga la sonda. Si la sonda se extrae durante la cocción, esta continuará según el modo tradicional (sin tiempo programado). Sonará una señal acústica y la pantalla indicará que la sonda ha alcanzado la temperatura necesaria.

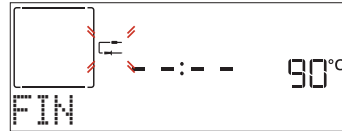



































Nota: Para cambiar los ajustes posteriormente, pulse + o - para acceder a la temperatura de la sonda o pulse << para acceder a otros ajustes. Una señal acústica y un mensaje le indicarán si el uso de la sonda no es compatible con la acción realizada. Si esto sucede, extraiga la sonda.



**TABLA DE COCCIÓN**

CATEGORÍAS DE ALIMENTOS		CANTIDAD	DAR LA VUELTA (DEL TIEMPO DE COCCIÓN)	NIVEL Y ACCESORIOS	
LASAÑA	-	0,5-3 kg	-	2	
CARNE	Buey asado	Asado (grado de cocción 0)	-	3	
		Hamburguesas (grado de cocción 0)	3/5	5 4	
		Asado-Cocción lenta (grado de cocción 0) *	0,6-2 kg **	-	3
	Cerdo asado	Asado	0,6-2,5 kg **	-	3
		Jarretes *	0,5-2,0 kg **	-	3
		Salchichas y Frankfurt	1,5-4 cm	2/3	5 4
	Ternera asada *	0,6-2,5 kg **	-	3	
	Cordero asado	Asado (grado de cocción 0) *	0,6-2,5 kg **	-	2
		Pierna (grado de cocción 0) *	0,5-2,0 kg **	-	2
	Pollo asado	Entero	0,6-3 kg **	-	2
		Entero relleno *	0,6-3 kg **	-	2
		Filete y pechuga	1-5 cm	2/3	5 4
	Pavo entero asado	Entero *	0,6-3 kg **	-	2
Entero relleno *		0,6-3 kg **	-	2	
Pinchos morunos	1 parrilla	1/2	5 4		



CATEGORÍAS DE ALIMENTOS		CANTIDAD	DAR LA VUELTA (DEL TIEMPO DE COCCIÓN)	NIVEL Y ACCESORIOS	
PESCADO	Filetes	0,5-3 cm	-	3  2 	
	Filetes congelados	0,5-3 cm	-	3  2 	
VERDURAS	Verduras asadas	Patatas	0,5-1,5 kg	-	3 
		Verduras rellenas	0,1-0,5 kg cada una	-	3 
		Verduras asadas	0,5-1,5 kg	-	3 
	Verduras gratinadas	Patatas	1 bandeja	-	3 
		Tomates	1 bandeja	-	3 
		Pimientos	1 bandeja	-	3 
		Brócoli	1 bandeja	-	3 
		Coliflor	1 bandeja	-	3 
		Otros	1 bandeja	-	3 
		TARTAS Y PASTELES DULCES	Pasteles en molde	Bizcocho	0,5-1,2 kg
Tartas dulces y tartas rellenas	Galletas	0,2-0,6 kg	-	3 	
	Pasta choux	1 bandeja	-	3 	
	Tarta	0,4-1,6 kg	-	3 	
	Strudel	0,4-1,6 kg	-	3 	
	Tarta rellena de frutas	0,5-2 kg	-	3 	
TARTAS SALADAS	-	0,8-1,2 kg	-	2 	
PAN	Bollos	60-150 g cada uno	-	3 	
	Barra de pan de molde	400-600 g cada una	-	2 	
	Pan grande	0,5-2,0 kg	-	2 	
	Baguettes	200-300 g cada una	-	3 	
PIZZA	Fina	bandeja redonda	-	2 	
	Gruesa	bandeja redonda	-	2 	
	Congelados	1 - 4 capas	-	2 	
				4  2 	
				5  3  1 	
				5  3  2  1 	

\* Solo en algunos modelos. Función disponible solo con la sonda para carne.

\*\* Cantidad recomendada.

ACCESORIOS



Rejilla



Bandeja de horno o molde sobre rejilla



Grasera / bandeja pastelera o bandeja de horno sobre rejilla



Grasera / Bandeja pastelera



































Grasera con 500 ml de agua



Sonda para carne (si la hay)

# TABLA DE COCCIÓN

RECETA	FUNCIÓN	PRECALENTAR	TEMPERATURA (°C)	DURACIÓN (MIN.)	REJILLAS Y ACCESORIOS
Bizcochos esponjosos		Sí	170	30 - 50	2
		Sí	160	30 - 50	2
		Sí	160	30 - 50	4 1
Tartas rellenas (tarta de queso, strudel, tarta de manzana)		Sí	160 - 200	30 - 85	3
		Sí	160 - 200	35 - 90	4 1
Galletas / Galletas de pastaflora		Sí	150	20 - 40	3
		Sí	140	30 - 50	4
		Sí	140	30 - 50	4 1
		Sí	135	40 - 60	5 3 1
Pastelitos / Magdalenas		Sí	170	20 - 40	3
		Sí	150	30 - 50	4
		Sí	150	30 - 50	4 1
		Sí	150	40 - 60	5 3 1
Lionesas		Sí	180 - 200	30 - 40	3
		Sí	180 - 190	35 - 45	4 1
		Sí	180 - 190	35 - 45 *	5 3 1
Merengues		Sí	90	110 - 150	3
		Sí	90	130 - 150	4 1
		Sí	90	140 - 160 *	5 3 1
Pizza / Pan / Focaccia		Sí	190 - 250	15 - 50	2
		Sí	190 - 230	20 - 50	4 1
Pizza (Fina, gruesa, focaccia)		Sí	220 - 240	25 - 50 *	5 3 1
Pizza congelada		Sí	250	10 - 15	3
		Sí	250	10 - 20	4 1
		Sí	220 - 240	15 - 30	5 3 1
Tartas saladas (tarta de verdura, quiche)		Sí	180 - 190	45 - 55	3
		Sí	180 - 190	45 - 60	4 1
		Sí	180 - 190	45 - 70 *	5 3 1
Volovanes / Canapés de hojaldre		Sí	190 - 200	20 - 30	3
		Sí	180 - 190	20 - 40	4 1
		Sí	180 - 190	20 - 40 *	5 3 1
Lasaña / flanes / pasta al horno / canelones		Sí	190 - 200	45 - 65	3
Cordero / ternera / buey / cerdo (1 kg)		Sí	190 - 200	80 - 110	3

## FUNCIÓNES



Convencional



Aire Forzado



Horno de convección



Grill



Turbo Grill



































































Maxi cocción



Cook 4



ECO Aire Forzado

RECETA	FUNCIÓN	PRECALENTAR	TEMPERATURA (°C)	DURACIÓN (MIN.)	REJILLAS Y ACCESORIOS
Cerdo asado con piel 2 kg		-	170	110 - 150	
Pollo / Conejo / Pato 1 kg		Sí	200 - 230	50 - 100	
Pavo / Oca (3 kg)		Sí	190 - 200	80 - 130	
Pescado al horno / en papillote (filetes, entero)		Sí	180 - 200	40 - 60	
Verduras rellenas (tomates, calabacines, berenjenas)		Sí	180 - 200	50 - 60	
Tostada		-	3 (Alta)	3 - 6	
Filetes pescado / Filete		-	2 (Media)	20 - 30 **	 
Salchichas / Pinchos morunos / Costillas / Hamburguesas		-	2 - 3 (Medio - Alto)	15 - 30 **	 
Pollo asado 1-1,3 kg		-	2 (Media)	55 - 70 ***	 
Pierna de cordero, jarretes		-	2 (Media)	60 - 90 ***	
Patatas asadas		-	2 (Media)	35 - 55 ***	
Verduras gratinadas		-	3 (Alta)	10 - 25	
Galletas	 Galletas	Sí	135	50 - 70	   
Tartas	 Tartas	Sí	170	50 - 70	   
Pizza redonda	 Pizza	Sí	210	40 - 60	   
Menú completo: Tarta de frutas (nivel 5), lasaña (nivel 3), carne (nivel 1)	 Menu	Sí	190	40 - 120 *	  
Menú completo: Tarta de frutas (nivel 5) / verduras asadas (nivel 4) / lasaña (nivel 2) / trozos de carne (nivel 1)	 Menu	Sí	190	40 - 120 *	   
Lasañas y carnes		Sí	200	50 - 100 *	 
Carnes y patatas		Sí	200	45 - 100 *	 
Pescado y verduras		Sí	180	30 - 50 *	 
Piezas de carne rellenas asadas		-	200	80 - 120 *	
Trozos de carne (conejo, pollo, cordero)		-	200	50 - 100 *	

\* Tiempo de cocción estimado: Los platos se pueden extraer del horno antes o después según los gustos personales.

\*\* Dar la vuelta al alimento a mitad de la cocción.

\*\*\* Dar la vuelta al alimento en el segundo tercio de la cocción (si fuera necesario).

#### CÓMO UTILIZAR LA TABLA DE COCCIÓN

La tabla indica la mejor función, accesorios y nivel para cocinar los diferentes tipos de alimentos. Los tiempos de cocción inician en el momento en que se coloca el alimento en el horno, excluyendo el precalentamiento (cuando sea necesario). Las temperaturas y los tiempos de cocción son orientativos y dependen de la cantidad de alimentos y del tipo de accesorio utilizado. En principio, aplique los valores de ajuste recomendados más bajos y, si la cocción no es suficiente, aumentelos. Utilice los accesorios suministrados y, si es posible, moldes y bandejas pasteleras metálicas de color oscuro. También puede utilizar recipientes y accesorios tipo pírax o de cerámica, aunque deberá tener en cuenta que los tiempos de cocción serán ligeramente mayores.

ACCESORIOS

 Rejilla

 Bandeja de horno o molde sobre rejilla

 Grasera / bandeja pastelera o bandeja de horno sobre rejilla

 Grasera / Bandeja pastelera

 Grasera con 500 ml de agua

 Sonda para carne (si la hay)

## LIMPIEZA Y MANTENIMIENTO

Asegúrese de que el horno se haya enfriado antes de llevar a cabo las tareas de mantenimiento o limpieza. No utilice aparatos de limpieza con vapor.

No utilice estropajos de acero, estropajos abrasivos ni productos de limpieza abrasivos/corrosivos, ya que podrían dañar las superficies del aparato.

Utilice guantes de protección. El horno debe desconectarse de la red eléctrica antes de llevar a cabo cualquier trabajo de mantenimiento.

### SUPERFICIES EXTERIORES

- Limpie las superficies con un paño húmedo de microfibra. Si están muy sucias, añada unas gotas de detergente neutro al agua. Seque con un paño seco.
- No utilice detergentes corrosivos ni abrasivos. Si uno de esos productos entra accidentalmente en contacto con la superficie del aparato, límpielo de inmediato con un paño húmedo de microfibra.

### SUPERFICIES INTERIORES

- Después de cada uso deje que el horno se enfríe y, a continuación, límpielo, preferiblemente cuando aún esté tibio, para quitar los restos o las manchas causadas por los residuos de los alimentos. Para secar la condensación que se haya podido formar debido a la cocción de alimentos con un alto contenido en agua, deje que el horno se enfríe por completo y límpielo con un paño o esponja.

- Limpie el cristal de la puerta con un detergente líquido adecuado.
- Para limpiar el horno con facilidad, quite la puerta.

### ACCESORIOS

Después del uso, sumerja los accesorios en una solución líquida con detergente, utilizando guantes si aún están calientes. Los residuos de alimentos pueden quitarse con un cepillo o esponja.

## EXTRACCIÓN E INSTALACIÓN DE LA PUERTA

1. Para quitar la puerta, ábrala por completo y baje los pestillos hasta que estén en posición desbloqueada.

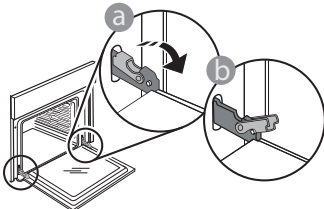

2. Cierre la puerta tanto como pueda. Sujete bien la puerta con las dos manos –no la sujete por el asa. Simplemente extraiga la puerta continuando cerrándola y a la vez levantándola hasta que se salga de su alojamiento. Ponga la puerta en un lado, apoyada sobre una superficie blanda.

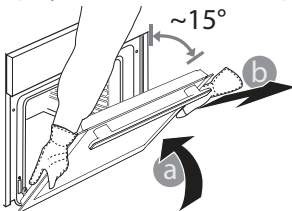

3. Vuelva a instalar la puerta llevándola hacia el horno, alineando los ganchos de las bisagras con sus alojamientos y fijando la parte superior en su alojamiento.
4. Baje la puerta y ábrala por completo. Baje los pestillos a su posición original: Asegúrese de haberlos bajado por completo.

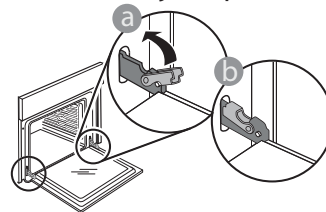

Presione suavemente para comprobar que los pestillos están en la posición correcta.

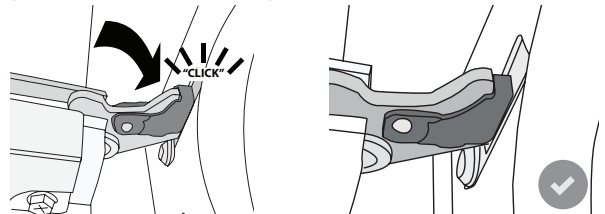

5. Intente cerrar la puerta y compruebe que esté alineada con el panel de control. Si no lo está, repita los pasos de arriba: La puerta podría dañarse si no funciona correctamente.

## SUSTITUCIÓN DE LA LÁMPARA

1. Desconecte el horno de la red eléctrica.
2. Desenrosque la tapa de la lámpara, sustituya la bombilla y vuelva a enroscar la tapa de la lámpara.
3. Vuelva a conectar el horno a la red eléctrica.

Nota: Utilice sólo bombillas halógenas de 20-40W/230 ~ V tipo G9, T300 °C. La bombilla que se usa en el aparato está diseñada específicamente para electrodomésticos y no es adecuada para la iluminación general de estancias de una vivienda (Normativa CE 244/2009). Las bombillas están disponibles en nuestro Servicio Postventa.

- Si utiliza lámparas halógenas, no las toque con las manos desnudas ya que las huellas dactilares podrían dañarlas. No utilice el horno hasta que no haya vuelto a colocar la tapa de la bombilla.

## RESOLUCIÓN DE PROBLEMAS

PROBLEMA	CAUSA POSIBLE	SOLUCIÓN
El horno no funciona.	Corte de suministro. Desconexión de la red eléctrica.	Compruebe que haya corriente eléctrica en la red y que el horno esté enchufado a la toma de electricidad. Apague el horno y vuelva a encenderlo para comprobar si se ha solucionado el problema.
En la pantalla aparecerá la letra «F» seguida de un número o letra.	Fallo del horno.	Apague el horno y vuelva a encenderlo para comprobar si se ha solucionado el problema. Intente ejecutar la función «RES. AJUSTE FAB.», que puede seleccionar en «AJUSTES». Póngase en contacto con el Servicio Postventa más cercano e indique el número que aparece detrás de la letra «F».
El horno no se calienta.	Cuando «DEMO» está establecido en «On», todos los mandos están activos y los menús disponibles, pero el horno no se calienta. DEMO aparecerá en la pantalla cada 60 segundos.	Acceda a «DEMO» desde «AJUSTES» y seleccione «Off».
La luz se apaga.	El modo «ECO» está activado.	Acceda a «ECO» desde «AJUSTES» y seleccione «Off».
La puerta no se abre.	Ciclo de limpieza en curso.	Espere a que termine la función y a que se enfríe el horno.
El suministro eléctrico de la casa se desconecta.	Configuración de potencia incorrecta.	Compruebe que la red doméstica tenga una potencia superior a 3 kW. Si o es así, reduzca la potencia a 13 amperios. Acceda a «POTENCIA» en «AJUSTES» y seleccione «BAJA».



Puede descargarse las Instrucciones de seguridad, el Manual del usuario, la Ficha del producto y los Datos de energía:

- Visitando nuestra página web [docs.whirlpool.eu](http://docs.whirlpool.eu)
- Usando el código QR
- También puede, **ponerse en contacto con nuestro Servicio postventa** (Consulte el número de teléfono en el folleto de la garantía). Cuando se ponga en contacto con nuestro Servicio Postventa, deberá indicar los códigos que figuran en la placa de características de su producto.

