

Energizer

UE10055PQ



Download Manual

EN

Specification :
 Model Name : UE10055PQ
 Cell Type : Lithium Polymer
 Battery Capacity : 10000mAh / 37Wh(Max)
 Rated Input : USB-C PD 5V/3A, 9V/2A
 Rated Output 1 : USB-C PD 5V/3A, 9V/2.22A, 12V/1.5A
 Rated Output 2 : USB-C PD 5V/3A, 9V/2.22A, 12V/1.5A
 Rated Output 3 : USB-A 5V/3A, 5V/4.5A, 4.5V/5A, 9V/2A, 12V/1.5A
 Total Output : 22.5W (Max)
 Dimensions : 145.5(L) x 69.2(W) x 16.1(H) mm
 Weight : 215g ± 10g

Package Contents

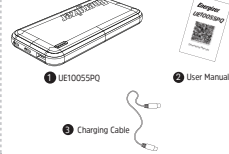

- 1 UE10055PQ
- 2 User Manual
- 3 Charging Cable

How to USE

Press the power button to activate charging on your device

LED Indicator	0%~24%
LED Indicator	25%~49%
LED Indicator	50%~74%
LED Indicator	75%~100%

Recharge Mode
 Blinking light indicates recharging.
 Solid light indicates fully charged.

How to Recharge

LED Indicator

22.5W USB-A FAST CHARGE

USB-C PD IN/OUT

USB-C PD OUT

Power Check Button

Connect the USB-C end to the input port to recharge

Connect the charging cable to a universal USB AC adapter.

Adapter NOT included

PowerSafe Management

Guarantees against short circuit and over-charging for your power bank and devices.

Customer Service

For any question about the product, please contact us at en@energizerpowerpacks.com

FC CE RECYCLE

WARRANTY

All products from the date of purchase are qualified for limited time warranty. For more warranty information, please visit: <http://www.energizerpowerpacks.com>

Dispose the battery properly, seek for local disposal facility for advice. Do not disassemble, dismantle, damage, or incinerate the battery at all times.

©2024 Energizer, Energizer, Energizer Character and certain graphic designs are trademarks of Energizer Brands, LLC and related subsidiaries and are used under license by Firetech International Corp.

UM_2_UE10055PQ_EN_21

Energizer

UE10055PQ



Télécharger le manuel

FR

Specifications :
 Nom du modèle : UE10055PQ
 Type de cellule : Lithium Polymère
 Capacité de la batterie : 10000mAh / 37Wh (Max)
 Entrée nominale : USB-C PD 5V/3A, 9V/2A
 Sortie nominale 1 : USB-C PD 5V/3A, 9V/2.22A, 12V/1.5A
 Sortie nominale 2 : USB-C PD 5V/3A, 9V/2.22A, 12V/1.5A
 Sortie nominale 3 : USB-A 5V/3A, 5V/4.5A, 4.5V/5A, 9V/2A, 12V/1.5A
 Sortie totale : 22.5W (Max)
 Dimensions : 145.5(L) x 69.2(W) x 16.1(H) mm
 Poids : 215g ± 10g

Contenu du paquet



- 1 UE10055PQ
- 2 Manuel de l'utilisateur
- 3 Câble de charge

Comment UTILISER

Appuyez sur le bouton d'alimentation pour activer la charge sur votre appareil

LED Indicateur	0%~24%
LED Indicateur	25%~49%
LED Indicateur	50%~74%
LED Indicateur	75%~100%

Mode de recharge
 La lumière clignotante indique la recharge.
 La lumière fixe indique que la charge est complète.

Comment Recharger

Indicateur LED

Charge rapide USB-A 22.5W

Entrée/sortie USB-C PD

Sortie USB-C PD

Bouton de vérification de puissance

Connectez l'extrémité USB-C au port d'entrée pour recharger

Connectez le câble de chargement à un adaptateur secteur USB universel.

Adaptateur NON inclus

PowerSafe-beheer

Garanteert bescherming tegen kortsluiting en overladen voor uw powerbank en apparaten.

klantenservice

Voor vragen over het product, neem contact met ons op via en@energizerpowerpacks.com

FC CE RECYCLE

GARANTIE:

Alle producten vanaf de datum van aankoop zijn geschikt voor een beperkte garantie. Voor meer garantie-informatie, bezoekt <http://www.energizerpowerpacks.com>

Doel de batterij op de juiste manier weg te gooien en zoek afvalverwerkingsbedrijf voor advies. Doel de batterij nooit weg te gooien, beschadigen, bevestigen of verbranden deze.

©2024 Energizer, Energizer, Energizer-merknaam en bepaalde grafische ontwerpen zijn handelsmerken van Energizer Brands, LLC en gerelateerde dochterondernemingen en worden onder licentie gebruikt door Firetech International Corp.

UM_2_UE10055PQ_FR_21

Energizer

UE10055PQ



Descargar manual

SP

Especificación :
 Nombre del modelo : UE10055PQ
 Tipo de celda : Polímero de litio
 Capacidad de la batería : 10000mAh / 37Wh (max)
 Entrada nominal : USB-C PD 5V/3A, 9V/2A
 Salida nominal 1 : USB-C PD 5V/3A, 9V/2.22A, 12V/1.5A
 Salida nominal 2 : USB-C PD 5V/3A, 9V/2.22A, 12V/1.5A
 Salida nominal 3 : USB-A 5V/3A, 5V/4.5A, 4.5V/5A, 9V/2A, 12V/1.5A
 Salida total : 22.5W (máx)
 Dimensiones : 145.5(L) x 69.2(W) x 16.1(H) mm
 Peso : 215g ± 10g

Contenido del paquete

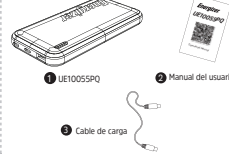

- 1 UE10055PQ
- 2 Manual del usuario
- 3 Cable de carga

Cómo USAR

Presione el botón de encendido para activar la carga en su dispositivo.

LED Indicador	0%~24%
LED Indicador	25%~49%
LED Indicador	50%~74%
LED Indicador	75%~100%

Modo de recarga
 La luz intermitente indica que se está recargando.
 La luz sólida indica que está completamente cargado.

Cómo Recargar

Indicador LED

Carga rápida USB-A de 22.5W

USB-C PD ENTRADA/SALIDA

USB-C PD SALIDA

Botón de comprobación de energía

Conecte el extremo USB-C al puerto de entrada para recargar.

Conecte el cable de carga a un adaptador de corriente USB universal.

Adaptador NO incluido

Gestión PowerSafe

Garantiza contra cortocircuitos y sobre carga para su banco de energía y dispositivos.

servicio al Cliente

Para cualquier pregunta sobre el producto, por favor contactarnos a en@energizerpowerpacks.com

FC CE RECYCLE

GARANTÍA

Todos los productos a partir de la fecha de compra califican para una garantía limitada. Para obtener más información sobre la garantía, visite <http://www.energizerpowerpacks.com>

Desmonte la batería correctamente. Nunca un centro de eliminación local para obtener consejos. No desmonte, desarme o incinere la batería en ningún momento.

©2024 Energizer, Energizer, Energizer Character y ciertos diseños gráficos son marcas comerciales de Energizer Brands, LLC y subsidiarias relacionadas y se utilizan bajo licencia de Firetech International Corp.

UM_2_UE10055PQ_SP_21

Energizer

UE10055PQ



Scarica il manuale

IT

Specifiche :
 Nome del modello : UE10055PQ
 Tipo di cella : Polimeri di litio
 Capacità della batteria : 10000mAh / 37Wh (max)
 Ingresso nominale : USB-C PD 5V/3A, 9V/2A
 Uscita nominale 1 : USB-C PD 5V/3A, 9V/2.22A, 12V/1.5A
 Uscita nominale 2 : USB-C PD 5V/3A, 9V/2.22A, 12V/1.5A
 Uscita nominale 3 : USB-A 5V/3A, 5V/4.5A, 4.5V/5A, 9V/2A, 12V/1.5A
 Uscita totale : 22.5W (max)
 Dimensione : 145.5(L) x 69.2(W) x 16.1(H) mm
 Peso : 215g ± 10g

Contenido del paquete



- 1 UE10055PQ
- 2 Manuale utente
- 3 Cavo di ricarica

Cómo USAR

Premere il pulsante di accensione per attivare la carica sul dispositivo.

LED Indicatore	0%~24%
LED Indicatore	25%~49%
LED Indicatore	50%~74%
LED Indicatore	75%~100%

Modalità di ricarica
 La luce lampeggiante indica la ricarica.
 La luce fissa indica che è completamente carica.

Cómo Recargar

Indicatore LED

Ricarica rapida USB-A 22.5W

USB-C PD IN/OUT

USB-C PD OUT

Pulsante di controllo di alimentazione

Collegare l'estremità USB-C alla porta di ingresso per ricaricare.

Collegare il cavo di ricarica a un adattatore AC USB universale.

Adattatore NON incluso

Gestione PowerSafe

Garantisce contro cortocircuiti e sovraccarichi per la tua power bank e dispositivi.

servizio Clienti

Per qualsiasi domanda sul prodotto, contattateci a en@energizerpowerpacks.com

FC CE RECYCLE

GARANZIA

Tutti i prodotti a data di acquisto sono coperti da garanzia limitata. Per ulteriori informazioni sulla garanzia, visitate <http://www.energizerpowerpacks.com>

Smontare correttamente la batteria, cercate un centro di smaltimento locale per consigli, consigli. Non smontare, smontare, danneggiare o incenerire la batteria in nessun momento.

©2024 Energizer, Energizer, Energizer Character e determinati design grafici sono marchi registrati di Energizer Brands, LLC e delle relative sussidiarie e sono utilizzati con licenza da Firetech International Corp.

UM_2_UE10055PQ_IT_21

Energizer

UE10055PQ



Handbuch herunterladen

DE

Spezifikation:
 Modellname: UE10055PQ
 Zellentyp: Lithium-Polymer
 Batteriekapazität: 10000mAh / 37Wh (Max.)
 Nenn-Eingang: USB-C PD 5V/3A, 9W/2A
 Nennausgang 1: USB-C PD 5V/3A, 9W/2.22A, 12V/1.5A
 Nennausgang 2: USB-C PD 5V/3A, 9W/2.22A, 12V/1.5A
 Nennausgang 3: USB-A 5V/3A, 5W/4.5A, 4.5V/5A, 9W/2A, 12V/1.5A
 Gesamtausgang: 22.5W (Max.)
 Abmessungen: 145.5(L) x 69.2(B) x 16.1(H) mm
 Gewicht: 215g ± 10g

Packungsinhalt

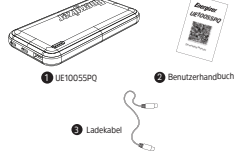

1 UE10055PQ 2 Benutzerhandbuch

3 Ladekabel

Wie BENUTZEN

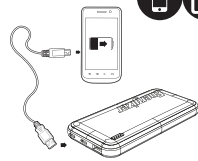

Drücken Sie die Ein-/Aus-Taste, um das Laden auf Ihrem Gerät zu aktivieren

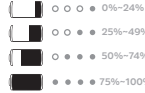

Lademodus:
 Blinkendes Licht zeigt das Aufladen an.
 Dauerhaftes Licht zeigt vollständig geladen an.

Wie aufladen

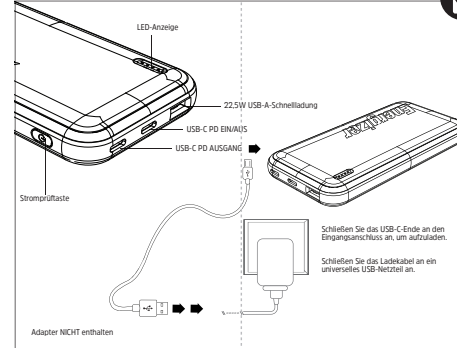

Adapter NICHT enthalten



PowerSafe-Management
 Garantiert gegen Kurzschlüsse und Überladungen für Ihre Powerbank und Geräte.



Kundendienst
 Für Fragen zum Produkt kontaktieren Sie uns bitte unter energizer@energizerpowerbanks.com



GARANTIE

Alle Produkte ab dem Kaufdatum sind für eine zeitlich begrenzte Garantie qualifiziert. Für weitere Garantiedetails besuchen Sie bitte <http://www.energizerpowerbanks.com>
 Entwerfen Sie die Batterie ordnungsgemäß, suchen Sie nach einer direkten Entladungsmöglichkeit für Batterien.
 Entwerfen, zerlegen, beschädigen oder verbrennen Sie die Batterie nicht zu jedem Zeit.
 ©2024 Energizer. Energizer, Energizer-Charakter und bestimmte grafische Designs sind Marken von Energizer Brands, LLC und sind urheberrechtlich geschützt und werden von Ternitech International Corp. oder einer Lizenz verwendet.

UM_2_UE10055PQ_DE_21

Energizer

UE10055PQ



Handleiding downloaden

NL

Specificatie:
 Modelnaam: UE10055PQ
 Celtype: Lithium-polymer
 Batteriekapaciteit: 10000mAh / 37Wh (Max.)
 Nominale ingang: USB-C PD 5V/3A, 9W/2A
 Nominale uitgang 1: USB-C PD 5V/3A, 9W/2.22A, 12V/1.5A
 Nominale uitgang 2: USB-C PD 5V/3A, 9W/2.22A, 12V/1.5A
 Nominale uitgang 3: USB-A 5V/3A, 5W/4.5A, 4.5V/5A, 9W/2A, 12V/1.5A
 Totale uitgang: 22.5W (Max.)
 Afmetingen: 145.5(L) x 69.2(B) x 16.1(H) mm
 Gewicht: 215g ± 10g

Inhoud van de verpakking

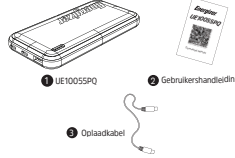

1 UE10055PQ 2 Gebruikershandleiding

3 Opladkabel

Hoe te GEBRUIKEN



Druk op de aan/uit knop om het opladen van uw apparaat te activeren

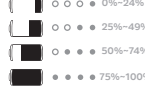

Oplaadmodus:
 Het knipperende licht geeft aan dat het opladen plaatsvindt.
 Het vaste licht geeft aan dat het volledig is opgeladen.

Wie aufladen

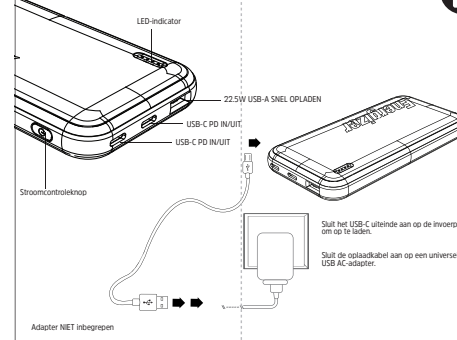

Adapter NIET inbegrepen



PowerSafe-beheer
 Garantiert bescherming tegen kortsluiting en overladen voor uw powerbank en apparaten.



Klantenservice
 Voor vragen over het product, neem contact met ons op via energizer@energizerpowerbanks.com



GARANTIE:

Alle producten ab dem Kaufdatum sind für eine zeitlich begrenzte Garantie qualifiziert. Für weitere Garantiedetails besuchen Sie bitte <http://www.energizerpowerbanks.com>
 Entwerfen Sie die Batterie ordnungsgemäß, suchen Sie nach einer direkten Entladungsmöglichkeit für Batterien.
 Entwerfen, zerlegen, beschädigen oder verbrennen Sie die Batterie nicht zu jedem Zeit.
 ©2024 Energizer. Energizer, Energizer-Charakter und bestimmte grafische Designs sind Marken von Energizer Brands, LLC und sind urheberrechtlich geschützt und werden von Ternitech International Corp. oder einer Lizenz verwendet.

UM_2_UE10055PQ_NL_21

Energizer

UE10055PQ



Baixar manual

PT

Especificações:
 Nome do modelo: UE10055PQ
 Tipo de célula: Polímero de lítio
 Capacidade da bateria: 10000mAh / 37Wh (máximo)
 Entrada nominal: USB-C PD 5V/3A, 9W/2A
 Saída nominal 1: USB-C PD 5V/3A, 9W/2.22A, 12V/1.5A
 Saída nominal 2: USB-C PD 5V/3A, 9W/2.22A, 12V/1.5A
 Saída nominal 3: USB-A 5V/3A, 5W/4.5A, 4.5V/5A, 9W/2A, 12V/1.5A
 Saída total: 22.5W (máximo)
 Dimensões: 145.5(L) x 69.2(W) x 16.1(H) mm
 Peso: 215g ± 10g

Conteúdo da embalagem



1 UE10055PQ 2 Manual do Usuário

3 Cabo de Carregamento

Como USAR



Pressione o botão de energia para ativar o carregamento em seu dispositivo.

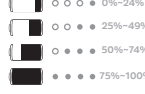

Modo de recarga:
 A luz intermitente indica que está a carregar.
 A luz sólida indica que está totalmente carregado.

Como Recarregar

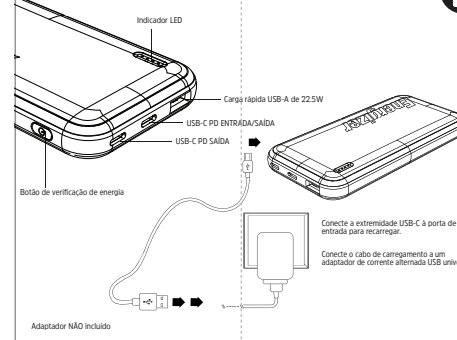

Adaptador NÃO incluído



Gerenciamento PowerSafe
 Garante proteção contra curto-circuitos e sobrecarga a seu banco de energia e dispositivos.



Serviço ao Cliente
 Para qualquer dúvida sobre o produto, entre em contato conosco em energizer@energizerpowerbanks.com



GARANTIA

Todos os produtos ab dem Kaufdatum sind für eine zeitlich begrenzte Garantie qualifiziert. Für weitere Garantiedetails besuchen Sie bitte <http://www.energizerpowerbanks.com>
 Entwerfen Sie die Batterie ordnungsgemäß, suchen Sie nach einer direkten Entladungsmöglichkeit für Batterien.
 Entwerfen, zerlegen, beschädigen oder verbrennen Sie die Batterie nicht zu jedem Zeit.
 ©2024 Energizer. Energizer, Energizer-Charakter und bestimmte grafische Designs sind Marken von Energizer Brands, LLC und sind urheberrechtlich geschützt und werden von Ternitech International Corp. oder einer Lizenz verwendet.

UM_2_UE10055PQ_PT_21

Energizer

UE10055PQ



Pobierz instrukcję obsługi

PL

Specyfikacja:
 Nazwa modelu: UE10055PQ
 Typ ogniw: Polimer litowy
 Pojemność baterii: 10000mAh / 37Wh (maks.)
 Napięcie wejściowe: USB-C PD 5V/3A, 9W/2A
 Napięcie wyjściowe 1: USB-C PD 5V/3A, 9W/2.22A, 12V/1.5A
 Napięcie wyjściowe 2: USB-C PD 5V/3A, 9W/2.22A, 12V/1.5A
 Napięcie wyjściowe 3: USB-A 5V/3A, 5W/4.5A, 4.5V/5A, 9W/2A, 12V/1.5A
 Całkowita moc wyjściowa: 22.5W (maks.)
 Wymiary: 145.5(L) x 69.2(W) x 16.1(H) mm
 Waga: 215g ± 10g

Zawartość paczki

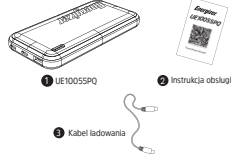

1 UE10055PQ 2 Instrukcja obsługi

3 Kabel ładowania

Jak UŻYĆ



Naciśnij przycisk zasilania, aby uruchomić ładowanie urządzenia.

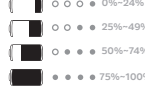

Tryb ładowania:
 Mijające światło oznacza ładowanie.
 Świecące światło oznacza pełne naładowanie.

Jak Naładować

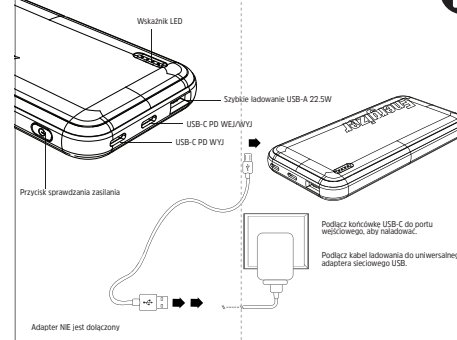

Adapter NIE jest dołączony



Zarządzanie PowerSafe
 Gwarantuje ochronę przed zwarciami i przedobciążeniami dla Twojego banku energii i urządzeń.



Obsługa klienta
 W przypadku jakiegokolwiek pytania dotyczących produktu, skontaktuj się z nami pod adresem energizer@energizerpowerbanks.com



GWARANCJA

Wszystkie produkty ab dem Kaufdatum sind für eine zeitlich begrenzte Garantie qualifiziert. Für weitere Garantiedetails besuchen Sie bitte <http://www.energizerpowerbanks.com>
 Entwerfen Sie die Batterie ordnungsgemäß, suchen Sie nach einer direkten Entladungsmöglichkeit für Batterien.
 Entwerfen, zerlegen, beschädigen oder verbrennen Sie die Batterie nicht zu jedem Zeit.
 ©2024 Energizer. Energizer, Energizer-Charakter und bestimmte grafische Designs sind Marken von Energizer Brands, LLC und sind urheberrechtlich geschützt und werden von Ternitech International Corp. oder einer Lizenz verwendet.

UM_2_UE10055PQ_PL_21

Energizer UE10055PQ



Изтегляне на ръководство

BG

Спецификация:
Модел: UE10055PQ
Тип на клетката: Литиев полимер
Капацитет на батерията: 10000mAh / 37Wh (макс.)
Оценен вход: USB-C PD 5V/3A, 9V/2A
Оценен изход 1: USB-C PD 5V/3A, 9V/2.22A, 12V/1.5A
Оценен изход 2: USB-C PD 5V/3A, 9V/2.22A, 12V/1.5A
Оценен изход 3: USB-A 5V/3A, 5V/4.5A, 4.5V/5A, 9V/2A, 12V/1.5A
Общ изход: 22.5W (макс.)
Размери: 145.5(L) x 69.2(W) x 16.1(H) mm
Тегло: 215g ± 10g

Съдържание на опаковката

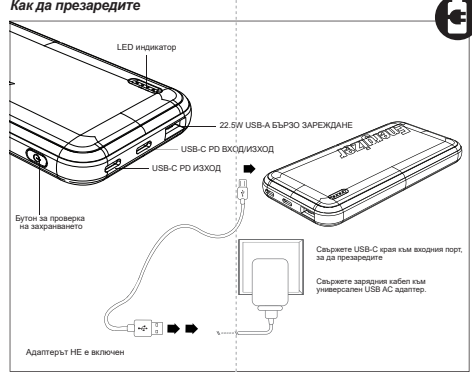
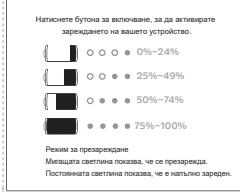

Управление на PowerSafe
Гарантира срещу всяко съвпадение и презареждане за вашата мобилна батерия и устройства.

Обслужване на клиенти
За всяко въпросно производство, моля свържете се с нас на service@energizerpowerpacks.com

CE, RoHS, REACH, GB, UKCA

ГАРАНЦИЯ
Вие сте предприели всички необходими действия за опазване на околната среда. За повече информация относно гаранцията, моля, посетете <http://www.energizerpowerpacks.com>
Използвайте батерията правилно, потърсете местно звено за обслужване за съвети.
Винаги на изключване, разглобяване, повреда или други изградни дефекти.

©2024 Energizer. Energizer, Energizer-Brand и Universal Charger са търговски марки на Energizer Brands, LLC и използването на тези имена е изключително право на Energizer Brands, LLC или техните лицензирани търговци.

UM_2 UE10055PQ_BG_21

Energizer UE10055PQ



Stáhnout manuál

CS

Specifikace:
Model: UE10055PQ
Typ článku: Lithium Polymer
Kapacita baterie: 10000mAh / 37Wh (max.)
Nodročený vstup: USB-C PD 5V/3A, 9V/2A
Nodročený výstup 1: USB-C PD 5V/3A, 9V/2.22A, 12V/1.5A
Nodročený výstup 2: USB-C PD 5V/3A, 9V/2.22A, 12V/1.5A
Nodročený výstup 3: USB-A 5V/3A, 5V/4.5A, 4.5V/5A, 9V/2A, 12V/1.5A
Celkový výstup: 22.5W (max.)
Rozměry: 145.5(L) x 69.2(W) x 16.1(H) mm
Hmotnost: 215g ± 10g

Obsah balení

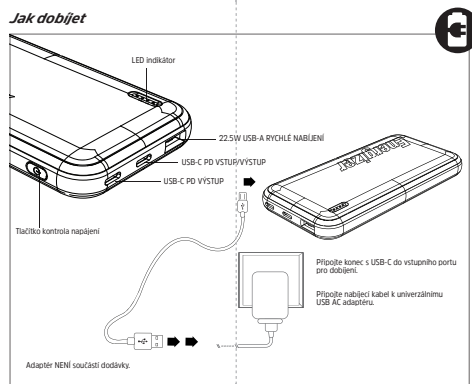
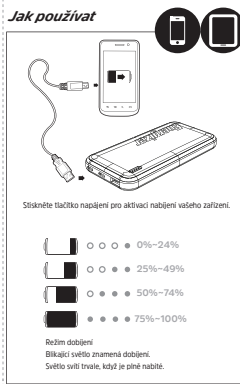
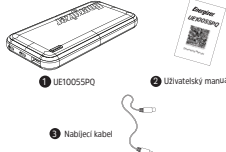

Správa PowerSafe
Záruka proti zkratu a zkrabění pro váš power bank a zařízení.

Zákaznická podpora
Pro jakýkoli dotaz ohledně produktu, kontaktujte nás na service@energizerpowerpacks.com

CE, RoHS, REACH, GB, UKCA

ZÁRUKA
Všechny výrobky jsou od data publikace ošetřeny i vzhledem k znečištění. Pro více informací o zásadách používání produktů, navštivte stránku <http://www.energizerpowerpacks.com>.
V každém případě i nevhodné nebo nevhodné použití, nebude ani nerozpouštějte baterie.

©2024 Energizer. Energizer, Energizer-Brand a Universal Charger jsou ochranné známky společnosti Energizer Brands, LLC a příslušného důstojného poskytovatele a jsou používány na základě licenčního smlouvy s Techni-Touch International Corp.

UM_2 UE10055PQ_CS_21

Energizer UE10055PQ



Download Manual

DA

Specifikationer:
Modelnavn: UE10055PQ
Celle type: Lithium Polymer
Batterikapacitet: 10000mAh / 37Wh (maks.)
Bædeind input: USB-C PD 5V/3A, 9V/2A
Bædeud output 1: USB-C PD 5V/3A, 9V/2.22A, 12V/1.5A
Bædeud output 2: USB-C PD 5V/3A, 9V/2.22A, 12V/1.5A
Bædeud output 3: USB-A 5V/3A, 5V/4.5A, 4.5V/5A, 9V/2A, 12V/1.5A
Samlet output: 22.5W (maks.)
Dimensioner: 145.5(L) x 69.2(W) x 16.1(H) mm
Vægt: 215g ± 10g

Pakningsindhold

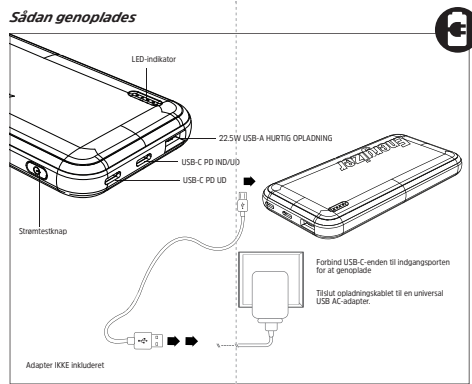
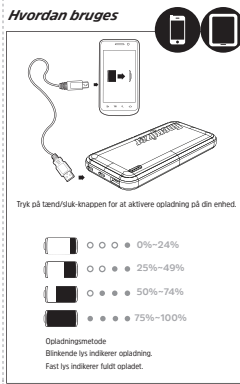
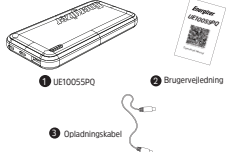

PowerSafe Management
Garanti mod kortslutning og overopladning af din powerbank og enheder.

kundeservice
For spørgsmål om produktet, kontakt os venligst på service@energizerpowerpacks.com

CE, RoHS, REACH, GB, UKCA

GARANTI
Alle produkter fra vores virksomhed kvalificerer sig til begrænset tids garanti. For mere garantiforetegnelser, bedes venligst gå til <http://www.energizerpowerpacks.com>

Bortkast batterier korrekt, selv tilslut jordstiftelsesstærke for jord.
Bortkast, adskilt, bænkaldt eller forbrændt aldrig batterier.

©2024 Energizer. Energizer, Energizer-Brand og Universal Charger design er varemærker tilhørende Energizer Brands, LLC og tilhørende datterselskaber og anvendes under licens af Techni-Touch International Corp.

UM_2 UE10055PQ_DA_21

Energizer UE10055PQ



Λήψη εγχειριδίου

EL

Προδιαγραφές:
Όνομα Μοντέλου: UE10055PQ
Τύπος Κελίου: Λίθιο Πολυμερές
Χαρητισμός Μπαταρίας: 10000mAh / 37Wh (Μέγιστη)
Αξιολογημένη Έξοδος: USB-C PD 5V/3A, 9V/2A
Αξιολογημένη Έξοδος 1: USB-C PD 5V/3A, 9V/2.22A, 12V/1.5A
Αξιολογημένη Έξοδος 2: USB-C PD 5V/3A, 9V/2.22A, 12V/1.5A
Αξιολογημένη Έξοδος 3: USB-A 5V/3A, 5V/4.5A, 4.5V/5A, 9V/2A, 12V/1.5A
Συνολική Έξοδος: 22.5W (Μέγιστη)
Διαστάσεις: 145.5(M) x 69.2(Π) x 16.1(Υ) χιλ.
Βάρος: 215gr ± 10gr

Περιεχόμενο συσκευασίας

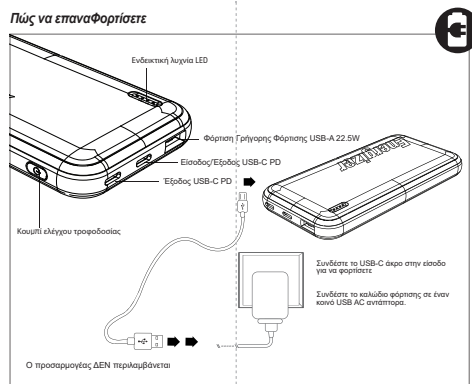
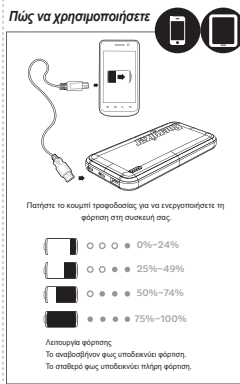

Διοίκηση PowerSafe
Εγγύηση εναντίον βραχυκυκλώματος και υπερφόρτισης για την προστασία της συσκευής σας.

Εξυπηρέτηση πελατών
Για οποιαδήποτε ερώτηση σχετικά με το προϊόν, παρακαλούμε επικοινωνήστε μαζί μας στην ιστοσελίδα service@energizerpowerpacks.com

CE, RoHS, REACH, GB, UKCA

ΕΓΓΥΗΣΗ
Όλα τα προϊόντα από την παραγωγή μας πληρούν τις προϋποθέσεις για παρακολούθηση εγγύησης. Για περισσότερες πληροφορίες σχετικά με την εγγύηση, παρακαλούμε επισκεφθείτε <http://www.energizerpowerpacks.com>
Απορρίψτε σωστά τη μπαταρία. Οδηγία ανακύκλωσης για τα περσικά κράνη φόρτισης.
Ποτέ μην απορρίπτετε, αποσυναρμολογείτε, διακίπτε ή εκρήκντε σε φωτιά τις μπαταρίες.

©2024 Energizer. Τα εμπορικά σήματα Energizer, Energizer-Brand και Universal Charger και σχετικές ετικέτες, λογότυπα και χρησιμοποιούνται υπό άδεια από τη Techni-Touch International Corp.

UM_2 UE10055PQ_EL_21

Energizer UE10055PQ



Halaðu niður leiðbeiningar

IS

IS
Tæknilegar upplýsingar :
Merkinúmer : UE10055PQ
Fræminging : Lithium Polymer
Rafhæðugleika : 10000mAh / 37Wh (Hámark)
Einkunn fyrir inntreymi : USB-C PD 5V/3A, 9W/2A
Einkunn fyrir ústreymi 1 : USB-C PD 5V/3A, 9W/2.22A, 12V/1.5A
Einkunn fyrir ústreymi 2 : USB-C PD 5V/3A, 9W/2.22A, 12V/1.5A
Einkunn fyrir ústreymi 3 : USB-A 5V/3A, 5V/4.5A, 4.5V/5A, 9W/2A, 12V/1.5A
Heldúlstreymi : 22.5W (Hámark)
Stærðir : 145.5(L) x 69.2(B) x 16.1(H) mm
Þyngd : 215g ± 10g

Innihald pakkingar

- 1 UE10055PQ
- 2 Notunarléiðbeiningar
- 3 Hleðslukerfi

Hvernig á að nota

Þú ert á aðfa hrappinn til að virka hleðuna á tækiinu þínu.

0%	0%	0%	0%	0%–24%
10%	10%	10%	10%	25%–49%
20%	20%	20%	20%	50%–74%
30%	30%	30%	30%	75%–100%

Endurláðunahvarf
Blinkandi ljós bendir á endurlögun.
Fast ljós bendir á fulla hleðu.

Hvernig á að endurlaða

LED viðbending
22.5W USB-A HRÖÐ HLEÐSLA
USB-C PD INN/ÚT
USB-C PD ÚT
Rafmagnsgartakli
Tengdu USB-C endanum í innlokisöpm til endurlöðu.
Tengdu hleðsluáhrif vör algeimlegan USB AC viðham.

Sneiðin ER EKKI með

PowerSafe stjórnun
Toppögnir sérgjaf skammtiálds og ofurlöðun fyrir farfölu þína og tæki.

Þjónusta við viðskiptavini
Þú ert einhverjar ógættir og um vísu, vinnsmægast hálfi samband við okkur á www.energizerpowerpacks.com

FCC CE RECYCLE

ÁBYRGD
Aðrir áhrif frá þessum gættinu eru kveðin frá salsmarkaðum ísmalþýgum. Þú ert frestar löggæfingur um ábyrgð, vinnsmægast hálfi samband <http://www.energizerpowerpacks.com>

Hættu við reifhæðuna á reitan hatt, leitaðu ráðgjafar í reifbúðunum yfirbúðunum, láttu hærrið, skilgreind, útskiðað eða breytt reifhæðuna.

©2024 Energizer. Energizer, Energizer karakter og ákveðin grafísk höfundur eru vörumerki Energizer Brands, LLC og tengda undirmerka og eru notuð með leyfi frá Tenergy International Corp. Bandaríkum.

UM_2_UE10055PQ_IS_2.1

Energizer UE10055PQ



Atsisiyskrite vadovą

LT

LT
Specifikacija :
Modelo pavadinimas : UE10055PQ
Lapitelis tipas : Lithium polimeras.
Baterijos talpa : 10000mAh / 37Wh (Maks.)
Įvertintas įvestis : USB-C PD 5V/3A, 9W/2A
Įvertintas išvestis 1 : USB-C PD 5V/3A, 9W/2.22A, 12V/1.5A
Įvertintas išvestis 2 : USB-C PD 5V/3A, 9W/2.22A, 12V/1.5A
Įvertintas išvestis 3 : USB-A 5V/3A, 5V/4.5A, 4.5V/5A, 9W/2A, 12V/1.5A
Visa išvestis : 22.5W (Maks.)
Matmenys : 145.5(į) x 69.2(į) x 16.1(Aukšt.) mm
Svoris : 215g ± 10g

Pakuotės turinys

- 1 UE10055PQ
- 2 Vartotojo vadovas
- 3 Įkrovimo kabelis

Kaip naudoti

Paspasakite malšinimo mygtuką, kad jungtumėt įkrovimą į savo reikini.

0%	0%	0%	0%	0%–24%
10%	10%	10%	10%	25%–49%
20%	20%	20%	20%	50%–74%
30%	30%	30%	30%	75%–100%

Įkrovimo režimas
Migloti šviesa rodo įkrovimą.
Pastovi šviesa rodo, kad įkrautas visiškai.

Kaip įkrauti

LED indikatorius
22.5W USB-A GREITAS ĮKROVIMAS
USB-C PD ĮEJIMAS/IŠEJIMAS
USB-C PD ĮEJIMAS
Malšinimo patikros mygtukas
Prijunkite USB-C galytį prie įvesties prievado, kad įkrautumėt.
Prijunkite įkrovimo kabelį prie universalio USB AC adapterio.

Adapteris NERA šikškitas

PowerSafe valdymas
Garantija prieš šilumą ir peršilimą, išvengiantis atšaldymo ir perkaitimo.

Klientų aptarnavimas
Jei turi kokią nors klausimą apie produktą, pratime susisiekti su mumis adresu www.energizerpowerpacks.com

FCC CE RECYCLE

GARANTUJA
Visi produktai turi garantiją, tačiau šie produktai išimtinai be garantijos. Norėdami gauti išsamesnę informaciją, pratime susisiekti su mumis adresu <http://www.energizerpowerpacks.com>

Atsisiyskrite vadovą, kad išsamesnę informaciją gautumėte. Šie produktai išimtinai be garantijos.

©2024 Energizer. Energizer, Energizer karakteris ir tam tikri grafikai išimtinai yra Energizer Brands, LLC ir susijusių kompanijų prekių ženklai ir naudojamos pagal Tenergy International Corp. licenciją.

UM_2_UE10055PQ_LT_2.1

Energizer UE10055PQ



Lejupielādējiet rokasgrāmatu

LV

LV
Specifikācijas :
Modela nosaukums : UE10055PQ
Aku tips : Litijū polimērs
Aku kapacitāte : 10000mAh / 37Wh (Maks.)
Novērtēta ieeja : USB-C PD 5V/3A, 9W/2A
Novērtēta izeja 1 : USB-C PD 5V/3A, 9W/2.22A, 12V/1.5A
Novērtēta izeja 2 : USB-C PD 5V/3A, 9W/2.22A, 12V/1.5A
Novērtēta izeja 3 : USB-A 5V/3A, 5V/4.5A, 4.5V/5A, 9W/2A, 12V/1.5A
Kopējā izeja : 22.5W (Maks.)
Izmēri : 145.5(Ļ) x 69.2(Ļ) x 16.1(A) mm
Svars : 215g ± 10g

Iepakojuma saturs

- 1 UE10055PQ
- 2 Lietotāja rokasgrāmata
- 3 Lādēšanas kabelis

Kā izmantot

Nospiediet iedēģšanas pogu, lai aktivizētu uzlādi savā ierīcē.

0%	0%	0%	0%	0%–24%
10%	10%	10%	10%	25%–49%
20%	20%	20%	20%	50%–74%
30%	30%	30%	30%	75%–100%

Uzlādes režīms
Mirgojošā gaismas signāls norāda uz uzlādi.
Pastāvīgā gaismas signāls norāda uz pilnīgu uzlādi.

Kā uzlādēt

LED indikatoris
22.5W USB-A ĀTRĀS UZLĀDES
USB-C PD IIEŠANA/IZIEŠANA
USB-C PD IZIEŠANA
Barošanas pārbaudes poga
Pievienojiet USB-C galytį prie portam, lai uzlādētu.
Pievienojiet uzlādes kabeli universālam USB AC adapterim.

Adapteris NAV iekļauts

PowerSafe vadība
Garantija pret šilumu un pāršilumu, izvengiantis atšaldymo ir perkaitimo.

Klientu aptarnavimas
Jei ir kāds jautājums par produktu, lūdzim susisiekt ar mums uz www.energizerpowerpacks.com

FCC CE RECYCLE

GARANTUJA
Visi produkti ir garantēti, taču šie produkti ir izņēmums. Ja vēlaties gūt papildu informāciju par garantiju, lūdzim kontaktēties ar mums uz <http://www.energizerpowerpacks.com>

Hættu við reifhæðuna á reitan hatt, leitaðu ráðgjafar í reifbúðunum yfirbúðunum, láttu hærrið, skilgreind, útskiðað eða breytt reifhæðuna.

©2024 Energizer. Energizer, Energizer karakteris un ákveðin grafísk höfundur eru vörumerki Energizer Brands, LLC og tengda undirmerka og eru notuð með leyfi frá Tenergy International Corp. Bandaríkum.

UM_2_UE10055PQ_LV_2.1

Energizer UE10055PQ



Pakningsinhald

NO

NO
Specifikasjon :
Modell navn : UE10055PQ
Celle typen : Litium-polimer
Akkumulatør kapasitet : 10000mAh / 37Wh (maks.)
Erteket input : USB-C PD 5V/3A, 9W/2A
Erteket Output 1 : USB-C PD 5V/3A, 9W/2.22A, 12V/1.5A
Erteket Output 2 : USB-C PD 5V/3A, 9W/2.22A, 12V/1.5A
Erteket Output 3 : USB-A 5V/3A, 5V/4.5A, 4.5V/5A, 9W/2A, 12V/1.5A
Totalt kimenet : 22.5W (maks.)
Måter : 145.5(ł) x 69.2(ł) x 16.1(H) mm
Søyl : 215g ± 10g

Cosmag tartalma

- 1 UE10055PQ
- 2 Felhasználói kézikönyv
- 3 Töltőkabel

Hogyan használik

Nyomja meg az bekapcsoló gombot, hogy aktiválja a töltést az eszközön.

0%	0%	0%	0%	0%–24%
10%	10%	10%	10%	25%–49%
20%	20%	20%	20%	50%–74%
30%	30%	30%	30%	75%–100%

Töltési mód
Világító fény jelzi a töltést.
Folyamatos fény jelzi a teljes feltöltöttséget.

Hogyan tölthető újra

LED jelzőfény
Sztybje ładowania USB-A 22.5W
USB-C PD WEJŚ/WYJŚ
USB-C PD WEJŚ
Azamielendző gomb
Człotkowanie do USB-C wtyku do ładowania lub do ładowania.
Człotkowanie do ładowania USB AC adapterem do ładowania.

Az adapter NEM tartozik hozzá

PowerSafe Kezelés
Garantia a hőszabályozás és a túlhűtés ellen, megelőzve az átvilágosítást és az átvilágosítást.

Ügyfélszolgálat
Ha van bármilyen kérdés a termékkel kapcsolatban, kérjük, forduljon hozzánk www.energizerpowerpacks.com

FCC CE RECYCLE

GARANTIA
Minden termékünk garantáltan tartós és megbízható. További információkért forduljon hozzánk <http://www.energizerpowerpacks.com>

Hættu við reifhæðuna á reitan hatt, leitaðu ráðgjafar í reifbúðunum yfirbúðunum, láttu hærrið, skilgreind, útskiðað eða breytt reifhæðuna.

©2024 Energizer. Energizer, Energizer karakteris og ákveðin grafísk höfundur eru vörumerki Energizer Brands, LLC og tengda undirmerka og eru notuð með leyfi frá Tenergy International Corp. Bandaríkum.

UM_2_UE10055PQ_NO_2.1

Energizer

UE10055PQ



Descărcați manualul

RO

Specificații:
Nume model : UE10055PQ
Tip celulă : Litiu Polimer
Capacitate baterie : 10000mAh / 37Wh (Maxim)
Intrare nominală : USB-C PD 5V/3A, 9V/2A
Ieșire nominală 1 : USB-C PD 5V/3A, 9V/2.22A, 12V/1.5A
Ieșire nominală 2 : USB-C PD 5V/3A, 9V/2.22A, 12V/1.5A
Ieșire nominală 3 : USB-A 5V/3A, 5V/4.5A, 4.5V/5A, 9V/2A, 12V/1.5A
Ieșire totală : 22.5W (Maxim)
Dimensiuni : 145.5(L) x 69.2(L) x 16.1(B) mm
Greutate : 215g ± 10g

Conținutul pachetului



- 1 UE10055PQ
- 2 Manual de utilizare
- 3 Cablu de încărcare

RU

Energizer

UE10055PQ



Презими упутство

RU

Характеристики:
Наименование модели : UE10055PQ
Тип аккумулятора : Литий-полимерный
Емкость батареи : 10000mAh / 37Wh (Макс.)
Номинальный вход : USB-C PD 5V/3A, 9V/2A, 12V/1.5A
Номинальный выход 1 : USB-C PD 5V/3A, 9V/2.22A, 12V/1.5A
Номинальный выход 2 : USB-C PD 5V/3A, 9V/2.22A, 12V/1.5A
Номинальный выход 3 : USB-A 5V/3A, 5V/4.5A, 4.5V/5A, 9V/2A, 12V/1.5A
Общая мощность : 22.5W (Макс.)
Габариты : 145.5(Д) x 69.2(Ш) x 16.1(В) мм
Вес : 215г ± 10г

Содержание упаковки



- 1 UE10055PQ
- 2 Содержание упаковки
- 3 Руководство пользователя

SK

Energizer

UE10055PQ



Stiahnuť príručku

SK

Specifikácia:
Modelové označenie : UE10055PQ
Typ článku : Lithium Polymer
Kapacita batérie : 10000mAh / 37Wh (Max.)
Hodnotný vstup : USB-C PD 5V/3A, 9V/2A
Hodnotný výstup 1 : USB-C PD 5V/3A, 9V/2.22A, 12V/1.5A
Hodnotný výstup 2 : USB-C PD 5V/3A, 9V/2.22A, 12V/1.5A
Hodnotný výstup 3 : USB-A 5V/3A, 5V/4.5A, 4.5V/5A, 9V/2A, 12V/1.5A
Celkový výstup : 22.5W (Max.)
Rozmery : 145.5(D) x 69.2(S) x 16.1(V) mm
Hmotnosť : 215g ± 10g

Obsah balenia

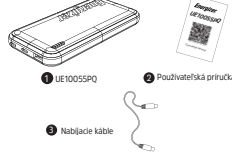

- 1 UE10055PQ
- 2 Používateľská príručka
- 3 Nabíjače káble

SL

Energizer

UE10055PQ



Prenesi navodila

SL

Specifikacije:
Model : UE10055PQ
Tip celice : Litij-polimer
Kapaciteta baterije : 10000mAh / 37Wh (najveća)
Ocenjeni vhod : USB-C PD 5V/3A, 9V/2A
Ocenjeni izhod 1 : USB-C PD 5V/3A, 9V/2.22A, 12V/1.5A
Ocenjeni izhod 2 : USB-C PD 5V/3A, 9V/2.22A, 12V/1.5A
Ocenjeni izhod 3 : USB-A 5V/3A, 5V/4.5A, 4.5V/5A, 9V/2A, 12V/1.5A
Skupni izhod : 22.5W (največ)
Dimenzije : 145.5(D) x 69.2(S) x 16.1(V) mm
Teža : 215g ± 10g

Vsebina paketa

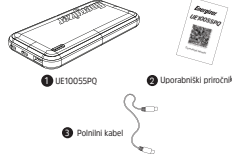

- 1 UE10055PQ
- 2 Uporabniški priročnik
- 3 Polnilni kabel

Cum să folosești

Apăsăți butonul de pornire pentru a activa încărcarea pe dispozitivul dvs.

0%–24%
25%–49%
50%–74%
75%–100%

Mod de încărcare
Lumina care clipește indică încărcarea.
Lumina constantă indică încărcarea completă.

Как использовать

Нажмите кнопку включения, чтобы активировать зарядку на вашем устройстве.

0%–24%
25%–49%
50%–74%
75%–100%

Режим зарядки
Мигающий свет указывает на зарядку.
Постоянный свет указывает на полную зарядку.

Ako používať

Stlačte tlačidlo zapnutia na aktiváciu nabíjania na vašom zariadení.

0%–24%
25%–49%
50%–74%
75%–100%

Rozličn nabíjanie
Blikajúce svetlo znáči nabíjanie.
Stále svetlo znáči úplne nabíj.

Kako uporabljati

Pritisnite gumb za vklop, da omogočite polnjenje vaše naprave.

0%–24%
25%–49%
50%–74%
75%–100%

Način polnjenja
Utripajoča lučka označuje, da se polni.
Stalna lučka označuje, da je baterija popolnoma napolnjena.

Cum să reîncarci

Indicator LED
Încărcare rapidă USB-A de 22.5W
USB-C PD Intrare/Ieșire
USB-C PD Ieșire
Buton de verificare a alimentării

Conectați cablul USB-C la portul de intrare pentru a reîncărca.
Conectați cablul de încărcare la un adaptor USB AC universal.

Adaptorul NU este inclus.

Как зарядить

Индикатор LED
Быстрая зарядка 22.5W USB-A
USB-C PD Вход/Выход
USB-C PD Выход
Кнопка проверки питания

Подключите конец USB-C к входному порту для зарядки.
Подключите кабель питания к универсальному USB AC адаптеру.

Адаптер НЕ включен.

Ako nabijati

LED indikator
22.5W USB-A RYCHLE NABÍJANIE
USB-C PD VSTUP/VÝSTUP
USB-C PD VÝSTUP
Tlačidlo kontroly napájania

Pripojte koniec USB-C k vstupnému portu na dobíjanie.
Pripojte nabíjač kábel k univerzálnemu adaptéru USB AC.

Adaptér NIE je súčasťou.

Kako napolniti

LED indikator
22.5W USB-A HITRO POLNILENJE
USB-C PD VNIZ
USB-C PD IZ
Gumb za preverjanje napajanja

Povežite konec USB-C v vhodni priključek za polnjenje.
Povežite polnilni kabel s univerzalnim USB AC adapterjem.

Adaptir ni priložen.

Managementul PowerSafe
Garantată protecția circuitului și suprîncărcări pentru bateria mobilă și dispozitivele dumneavoastră.

serviciu pentru clienți
Pentru orice întrebare despre produs, vă rugăm să ne contactați la service@energizerpowerpacks.com



GARANȚIE

Toate produsele Energizer și datele tehnice sunt garantate pentru o perioadă limitată în timp. Pentru mai multe informații despre garanție, vă rugăm să vizitați <http://www.energizerpowerpacks.com>

Energizer și toate bateriile incluse au un centru local de eliminare pentru defecte. Nu eliminați, demontați, dezinfectați sau încercați să reparați în niciun moment.

©2024 Energizer - Energizer, caracteristicile Energizer și amplasarea designului grafic sunt mărci comerciale ale Energizer Brands, LLC și a subsidiarilor sale și sunt utilizate sub brandul de TradeMark International Corp.

UM_2_UE10055PQ_RO_21

Управление PowerSafe
Гарантирует защиту от короткого замыкания и перегрева для вашего портативного аккумулятора и устройств.

Обслуживание клиентов
По любым вопросам о продукте, пожалуйста, свяжитесь с нами по адресу service@energizerpowerpacks.com



ГАРАНТИЯ

Все продукты Energizer имеют ограниченную временную гарантию. Для получения дополнительной информации о гарантии, посетите <http://www.energizerpowerpacks.com>

Наличием всех батарей, входящих в комплект, обеспечивается гарантия. Не пытайтесь починить, разобрать, не повреждать и не склеивать батареи. Всегда используйте только одобренные зарядные устройства.

©2024 Энерджиер - Энерджиер, характеристики Energizer и расположение дизайна графического являются товарными знаками Energizer Brands, LLC и ее связанных дочерних предприятий и используются под брендом TradeMark International Corp.

UM_2_UE10055PQ_RU_21

PowerSafe riadenie
Zaručuje ochrnu pred krátkym замыканием a preohrevom pre váš portálový akumulátor a zariadenia.

zákaznícká podpora
Pre akékoľvek otázky o produkte, prosím, kontaktujte nás na emailovú adresu service@energizerpowerpacks.com



ZÁRUKA

Všetchny výrobky od Energizer mají omezenou časovou záruku. Pro více informací o záruce, prosím, navštivte <http://www.energizerpowerpacks.com>

Nákladou všech baterií, které jsou součástí balení, je poskytnuta záruka. Nepokoušejte se baterie opravovat, rozmontovat, poškodit nebo lepit. Vždy používejte pouze schválené nabíječky.

©2024 Energizer - Energizer, charakteristika Energizer a umístění grafického designu jsou ochrannými známkami Energizer Brands, LLC a jejích dceřiných společností a jsou používány pod značkou TradeMark International Corp.

UM_2_UE10055PQ_SK_21

Upravljanje PowerSafe
Zagotavlja zaščito pred kratkimi stromi in preogrevanjem za vašo baterijsko banko in naprave.

Storitev za stranke
Za vse vprašanja o izdelku nas kontaktirajte na service@energizerpowerpacks.com



GARANCIJA

Vsi izdelki Energizer imajo omejeno časovno garancijo. Za več informacij o garanciji obiščite <http://www.energizerpowerpacks.com>

Priloge vse baterije, ki so vključene v komplet, zagotavljajo garancijo. Ne poskušajte baterije popraviti, razmontirati, poškodovati ali lepiti. Vedno uporabljajte samo odobrena polnilna naprava.

©2024 Energizer - Energizer, karakteristika Energizer in vse grafične elemente so zaščitene znamke družbe Energizer Brands, LLC in povezanih podjetij ter se uporabljajo pod blagovno znamko TradeMark International Corp.

UM_2_UE10055PQ_SL_21

Energizer UE10055PQ



Shkarkoni manualin

SO

Specifikimi :
Emri i modelit : UE10055PQ
Lloji i qelizës : Polimeri (li)
Kapaciteti i baterisë : 10000mAh / 37Wh (Maksimum)
Hyrja e vlerësuar : USB-C PD 5V/3A, 9V/2A
Dalja e vlerësuar 1 : USB-C PD 5V/3A, 9V/2.22A, 12V/1.5A
Dalja e vlerësuar 2 : USB-C PD 5V/3A, 9V/2.22A, 12V/1.5A
Dalja e vlerësuar 3 : USB-A 5V/3A, 5V/4.5A, 4.5V/5A, 9V/2A, 12V/1.5A
Dalja totale : 22.5W (Maksimum)
Dimenzionet : 145.5(G) x 69.2(L) x 16.1(H) mm
Peshë : 215g ± 10g

Përmbajtja e paketimit

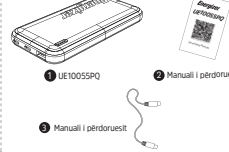

Si të përdoret

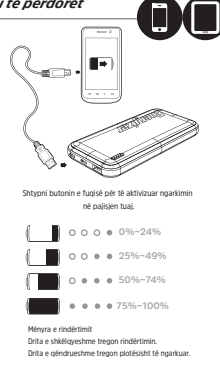

Si të ringjallni

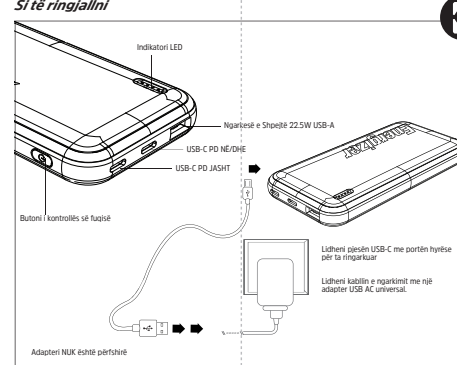

Menaxhimi PowerSafe
Garantim kundër rrezikut dhe ngarkimit së tepërta për baterinë tuaj portatib dhe pajisjet.



Shërbimi për Klientët
Për çdo pyetje në lidhje me produktin, ju lutemi na kontaktoni në energizer@energizerpowerpacks.com



GARANCIJA

Është garancie e produktit nga data e blerjes për një vit nga data e blerjes së kësaj baterie. Është me shumicë informacione në lidhje me garancinë, ju lutemi vizitoni <http://www.energizerpowerpacks.com>

Shërbimi i klientit në mënyrë të shpejtë dhe të sigurt për të gjitha pyetjet dhe kërkesat tuaja.

©2024 Energizer - Energizer, Energizer karakter dhe shënime tregtare janë marka të Energizer Brands, LLC dhe nënkombinime të këtyre dhe shërbimeve të tyre në të gjithë botën dhe në të gjithë botën.

UM_2_UE10055PQ_SO_21

Energizer UE10055PQ



Скачать руководство

SR

Specifikacione :
Model : UE10055PQ
Tipi i qelizës : Litiyumi polimer
Kapaciteti i baterisë : 10000mAh / 37Wh (Maksimum)
Oshënjimi hyrës : USB-C PD 5V/3A, 9V/2A, 12V/1.5A
Oshënjimi dalje 1 : USB-C PD 5V/3A, 9V/2.22A, 12V/1.5A
Oshënjimi dalje 2 : USB-C PD 5V/3A, 9V/2.22A, 12V/1.5A
Oshënjimi dalje 3 : USB-A 5V/3A, 5V/4.5A, 4.5V/5A, 9V/2A, 12V/1.5A
Udhëtimi i fuqisë : 22.5W (Maksimum)
Dimenzionet : 145.5(D) x 69.2(L) x 16.1(H) mm
Peshë : 215g ± 10g

Sadržaj pakovanja



Kako koristiti

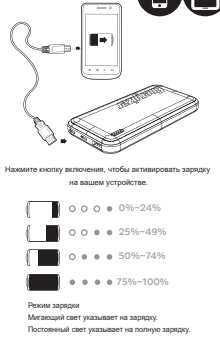

Kak зарядять

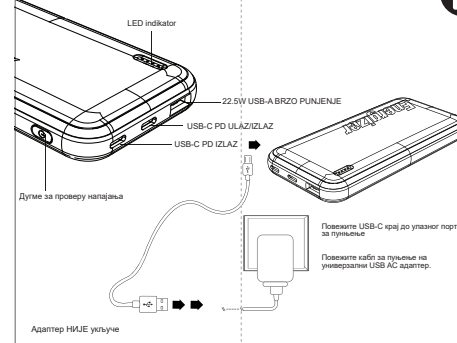

Управљање PowerSafe
Гаранција против прегревања и претераног пуњења за вашу преносну батерију и уређаје.



Korisnička podrška
За сва питања о производу, молимо контактирајте нас на energizer@energizerpowerpacks.com



GARANCIJA

Ова батерија је подложена гаранцији од једне године од датума набавке. За више информација о гаранцији, молимо посетите: <http://www.energizerpowerpacks.com>

Правилно одржавање батерије, покривање светла и одлагање светла су одлучујући фактори за дужи век трајања батерије.

©2024 Energizer - Energizer, Energizer karakteri i shënime tregtare janë marka të Energizer Brands, LLC dhe nënkombinime të këtyre dhe shërbimeve të tyre në të gjithë botën dhe në të gjithë botën.

UM_2_UE10055PQ_SR_21

Energizer UE10055PQ



Ladda ner manual

SV

Specifikationer :
Modellnamn : UE10055PQ
Celltyp : Lithium Polymer
Batterikapacitet : 10000mAh / 37Wh (Max.)
Betygsatt inmatning : USB-C PD 5V/3A, 9V/2A
Betygsatt utmatning 1 : USB-C PD 5V/3A, 9V/2.22A, 12V/1.5A
Betygsatt utmatning 2 : USB-C PD 5V/3A, 9V/2.22A, 12V/1.5A
Betygsatt utmatning 3 : USB-A 5V/3A, 5V/4.5A, 4.5V/5A, 9V/2A, 12V/1.5A
Total utmatning : 22.5W (Max.)
Måt : 145.5(L) x 69.2(B) x 16.1(H) mm
Vikt : 215g ± 10g

Innehåll i förpackningen

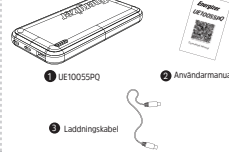

Hur man använder

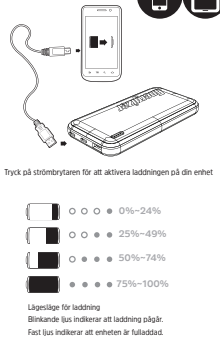

Hur man laddar

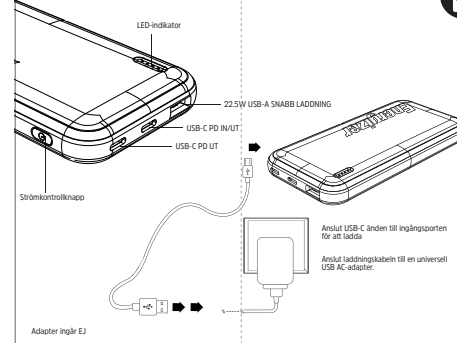

PowerSafe-bantering
Garanti mot överhettning och överladdning för din powerbank och enheter.



Kundtjänst
För eventuella frågor om produkten, vänligen kontakta oss på energizer@energizerpowerpacks.com



GARANTI

Den här batteriet är tillgängligt för begränsad tids garanti från inköpsdatumet. För mer garantiformation, besök: <http://www.energizerpowerpacks.com>

Använda batteriet på rätt sätt, kontakta tekniska stödteamet för rådgivning. Batteriet får inte kastas, demonteras, utsläppa eller föras över till andra enheter.

©2024 Energizer - Energizer, Energizer karakterer och shënime tregtare janë marka të Energizer Brands, LLC dhe nënkombinime të këtyre dhe shërbimeve të tyre në të gjithë botën dhe në të gjithë botën.

UM_2_UE10055PQ_SV_21

Energizer UE10055PQ



Завантажити посібник

UK

Specyfikacja :
Nazwa modelu : UE10055PQ
Typ akumulatora : Litium-polimerowy
Ciężkość akumulatora : 10000mAh / 37Wh (Max.)
Oceny wejścia : USB-C PD 5V/3A, 9V/2A
Oceny wyjścia 1 : USB-C PD 5V/3A, 9V/2.22A, 12V/1.5A
Oceny wyjścia 2 : USB-C PD 5V/3A, 9V/2.22A, 12V/1.5A
Oceny wyjścia 3 : USB-A 5V/3A, 5V/4.5A, 4.5V/5A, 9V/2A, 12V/1.5A
Zdolność wyjściowa : 22.5W (Max.)
Wymiary : 145.5(D) x 69.2(W) x 16.1(H) mm
Waga : 215g ± 10g

Вміст упаковки

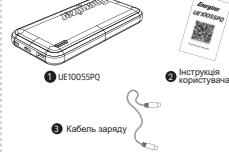

Як використовувати



Як перезаряджати

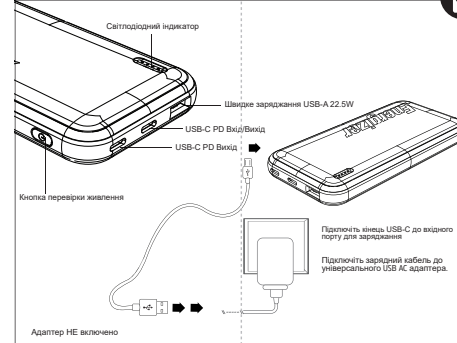

Управління PowerSafe
Гарантія захисту від короткого замикання та перезарядки для вашого портативного акумуляторного пристрою.



Обслуговування клієнтів
Для будь-яких питань про продукт, будь ласка, зв'яжіться з нами за адресою energizer@energizerpowerpacks.com



GARANTIA

Ця батарея є гарантованою однією річчю гарантією. Для отримання більш докладної інформації щодо гарантії, будь ласка, відвідайте <http://www.energizerpowerpacks.com>

Правильне використання батареї, накривання світла та відсутність світла є вирішальними факторами для довгого життя батареї.

©2024 Energizer - Energizer, Energizer karakteri i shënime tregtare janë marka të Energizer Brands, LLC dhe nënkombinime të këtyre dhe shërbimeve të tyre në të gjithë botën dhe në të gjithë botën.

UM_2_UE10055PQ_UK_21