

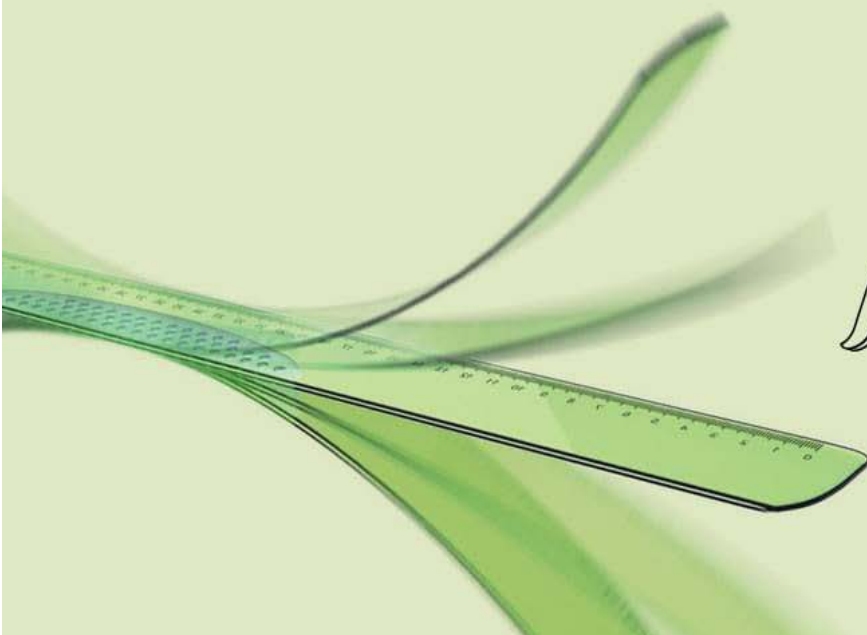

ARDA

La flessibilità che non ti aspetti

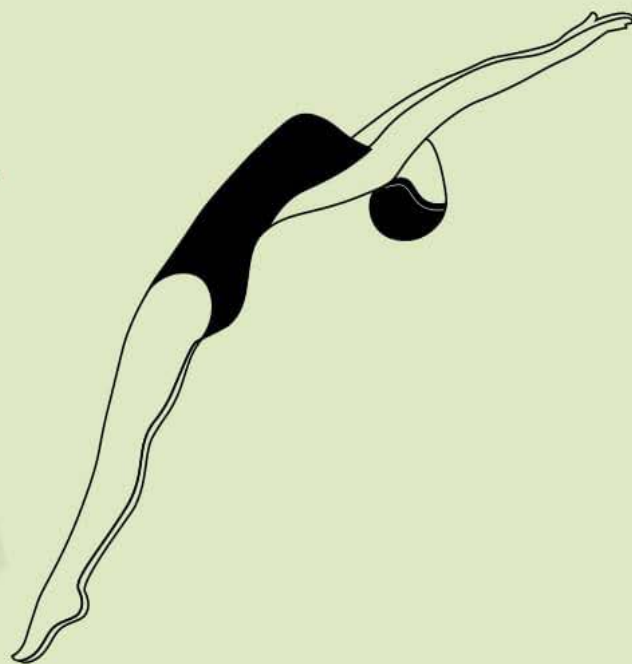

Arda's research has led to the development of Elastika®, an innovative range of technical drawing equipment made using a material offering a major advantage: the ability to bend and revert to its original shape without suffering any damage. It guarantees genuine technical drawing tools, combining flexibility with other essential features: transparency, undeformability and precision measurement.

The real difference that make Elastika® unique and inimitable.

Le département de recherche d'ARDA a donné naissance à Elastika®, une gamme innovante d'instruments de dessin technique réalisée dans une matière qui permet un résultat extraordinaire: la capacité de se plier et de revenir à sa forme originale sans se déformer est la certitude d'avoir en main un instrument qui allie la souplesse aux autres caractéristiques essentielles: transparence, stabilité de la forme et précision de la mesure.

La vraie différence qui fait de Elastika® une gamme unique et inimitable.

Dalla ricerca Arda è nata Elastika®, innovativa linea per il disegno. L'unica che puoi piegare ma torna sempre in forma, senza spezzarsi nè rovinarsi e con la garanzia di utilizzare un vero e proprio strumento da disegno tecnico, che abbina la flessibilità alle altre caratteristiche essenziali: trasparenza, stabilità di forma e precisione delle misure.

Queste le vere differenze che rendono Elastika® unica e inimitabile.

Made in Italy



Squadre 45° e 60°

Set square 45° and 60°
Equerre 45° et 60°

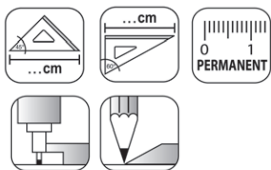

Smusso, tirachina e bordo interno
Bevelled edge, ink-edge and finger lift
Facette, bord anti-tache et bord intérieur

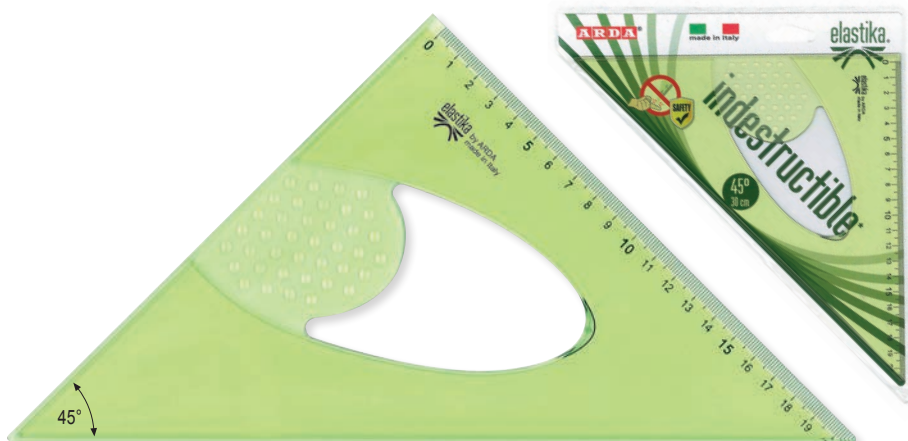
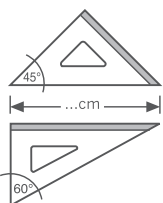

Ref. EL4520 - 30 - 35

Art.	EAN13 art.	Descrizione / Description	INNER pcs	EAN13 inner	MASTER pcs
EL4520	8003438012562	45° cm. 20	10	8003438012579	300
EL4530	8003438011091	45° cm. 30	10	8003438012036	220
EL4535	8003438011114	45° cm. 35	10	8003438012050	140



**PUNTE
ARROTONDATE
DI SICUREZZA**

**ROUND EDGES
FOR SECURITY**

**BOUTS RONDS POUR
PLUS DE SECURITÉ**

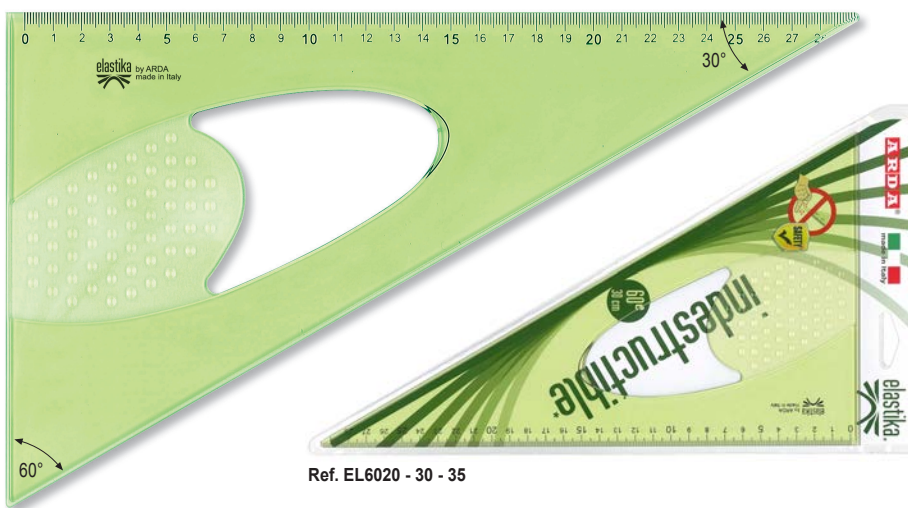

Ref. EL6020 - 30 - 35

Art.	EAN13 art.	Descrizione / Description	INNER pcs	EAN13 inner	MASTER pcs
EL6020	8003438012593	60° cm. 20	10	8003438012609	320
EL6030	8003438011107	60° cm. 30	10	8003438012043	200
EL6035	8003438011121	60° cm. 35	10	8003438012067	100

Righe

Rulers
Règles

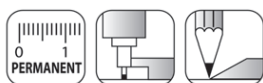

Smusso e tirachina
Bevelled edge and ink-edge
Facette et bord anti-tache



Ref. EL30-50-60



Art.	EAN13 art.	Descrizione / Description	INNER pcs	EAN13 inner	MASTER pcs
EL30	8003438011138	cm. 30	10	8003438012074	300
EL50	8003438011152	cm. 50	10	8003438012081	200
EL60	8003438013453	cm. 60	10	8003438013460	150

Righelli 15 cm

Rulers 15 cm
Règle 15 cm

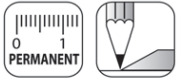

Smusso
Bevelled edge
Facette



20
pz/pcs

Ref. EL15ESP

Smusso "intelligente" per sollevare facilmente il righello dal foglio

"smart" bevel to easily lift the ruler from the sheet

Biseau "intelligent" pour prise en main facile de la règle



Ref. EL15

Art.	EAN13 art.	Descrizione / Description	INNER pcs	EAN13 inner	MASTER pcs
EL15ESP	8003438017963	Display 20 righelli cm.15 (art. sing. 8003438 018014)	1	8003438017963	1
EL15	8003438018014	Righello Elastika cm.15	10	8003438018021	10

Doppi e Tripli decimetri

Finger grip ruler 20-30cm
Double e triple décimètre



2 millimetrature. Impugnatura corta
2 graduations. Short grip
2 graduations. Poignée courte



Ref. EL20P

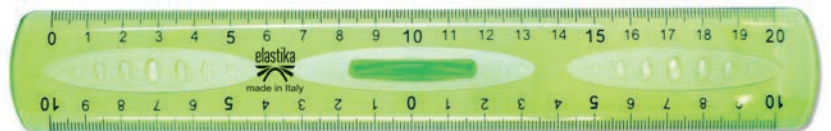

Ref. EL30P

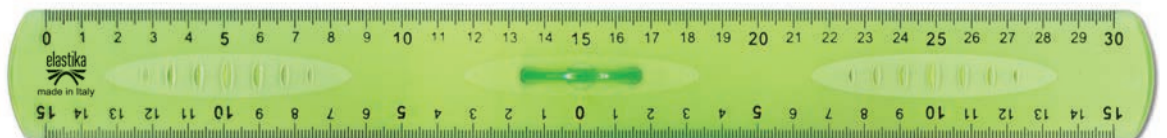

Art.	EAN13 art.	Descrizione / Description	INNER pcs	EAN13 inner	MASTER pcs
EL20P	8003438011176	cm. 20	10	8003438012098	200
EL30P	8003438011213	cm.30	10	8003438012104	240

Goniometro 180°

Protractor 180°
Rapporteur 180°

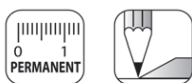

Smusso e bordo interno
Bevelled edge and finger lift
Facette et bord intérieur

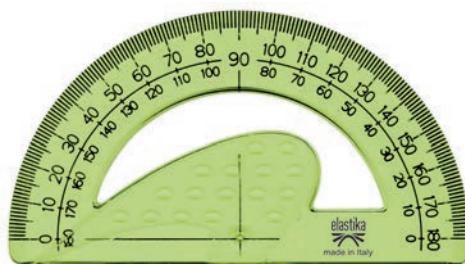

Ref. EL18012



Art.	EAN13 art.	Descrizione / Description	INNER pcs	EAN13 inner	MASTER pcs
EL18012	8003438011404	180° cm. 12	10	8003438012111	200

Goniometro 360°

Protractor 360°
Rapporteur 360°



Smusso e bordo interno
Bevelled edge and finger lift
Facette et bord intérieur

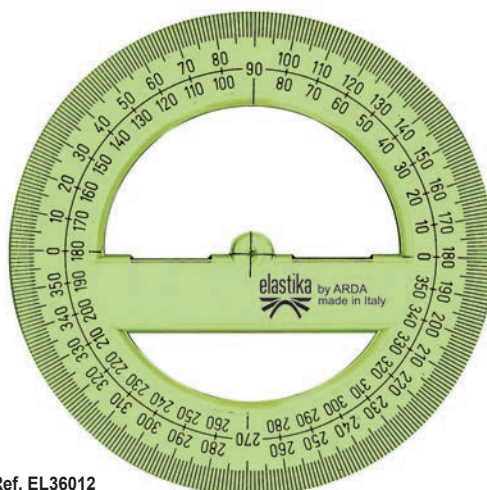

Ref. EL36012



Art.	EAN13 art.	Descrizione / Description	INNER pcs	EAN13 inner	MASTER pcs
EL36012	8003438011411	360° cm. 12	10	8003438012128	360

Squadra geometrica

Geometric square
Equerre géométrique

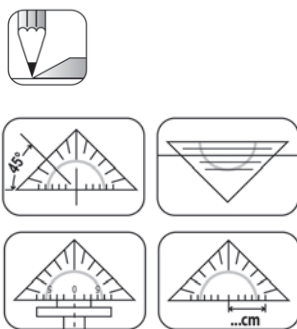

4 funzioni in 1
4 functions in 1 - 4 usages en 1

Ref. ELGEO300

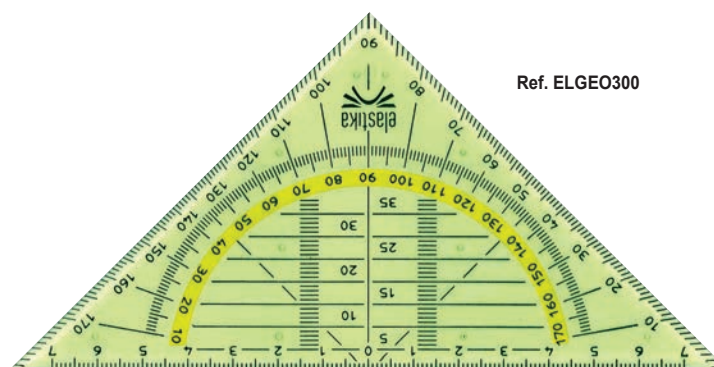

Art.	EAN13 art.	Descrizione / Description	INNER pcs	EAN13 inner	MASTER pcs
ELGEO300	8003438016140	Geo300 - 45° cm. 16	20	8003438016157	400

Espositori

Display - Presentoirs



Contenuto specifico per disegno tecnico su fogli A3

Specific content for technical drawing on A3 sheets

Contenu spécifique pour le dessin technique sur papier A3



Contenuto specifico per disegno tecnico su fogli A4

Specific content for technical drawing on A4 sheets

Contenu spécifique pour le dessin technique sur papier A4



Ref. EL4766
32,5 x 25 x 57 h. cm

61
pcs



Ref. EL4765F
32,5 x 25 x 51 h. cm

90
pcs

DISPLAY 61 pz / pcs

Art.	EAN13 art.	Descrizione / Description	INNER	MASTER
EL4766	8003438017987	10x Sq. 45°cm.30 - ref.EL4530 10x Sq. 60°cm.30 - ref. EL6030 1x display 20 righelli cm.15 - ref.EL15ESP 10x Righe cm. 50 - ref. EL50 10x Doppio dec. - ref. EL20P 10x Triplo dec. - ref. EL30P 10x Gon. 360°cm.12 - ref.EL36012	1	1

Disponibilità limitata alle campagne promozionali - Product availability limited to promotional campaigns - Disponibilité limitée aux campagnes promotionnelles

DISPLAY 90 pz / pcs

Art.	EAN13 art.	Descrizione / Description	INNER	MASTER
EL4765F	8003438013781	10x Sq. 45°cm.20 - ref. EL4520 20x Sq. 60°cm.20 - ref. EL6020 10x Righe cm.30 - ref. EL30 20x Doppio dec. - ref. EL20P 10x Triplo dec. - ref. EL30P 20x Gon. 180°cm.12 - ref.EL18012	1	1

Disponibilità limitata alle campagne promozionali - Product availability limited to promotional campaigns - Disponibilité limitée aux campagnes promotionnelles

Drawing items - Articles de tracage



Espositore da terra 200 pz.

Floor display stand 200 pcs - Presentoir au sol 200 pcs

Art.	EAN13 art.	Descrizione / Description	INNER	MASTER
500EL	8003438 032799	40x Sq. 45°cm.30 - ref.EL4530 40x Sq. 60°cm.30 - ref. EL6030 40x Righe cm. 30 - ref. EL30 40x Righe cm. 50 - ref. EL50 40x Gon. 360°cm.12 - ref.EL36012	1	1

Disponibilità limitata alle campagne promozionali - Product availability limited to promotional campaigns - Disponibilité limitée aux campagnes promotionnelles



Ref. 500EL

Tecniko

il corredo per disegno Elastika®

set for school elastika
kit de traçage elastika



ref. AST01

Tecniko
Corredo disegno
Elastika

Art.	EAN13 art.	INNER pcs	EAN13 inner	MASTER pcs
AST01	8003438030665	1	8003438030665	1

IN SCATOLA REGALO - GIFT BOX - EN COFFRET CADEAU

Per custodire tutto il necessario per il disegno tecnico !

To bring to school and protect everything you need for technical drawing !

Pour apporter à l'école et garder tout ce dont vous avez besoin pour le dessin technique !

Contenuto - Content - Contenu :

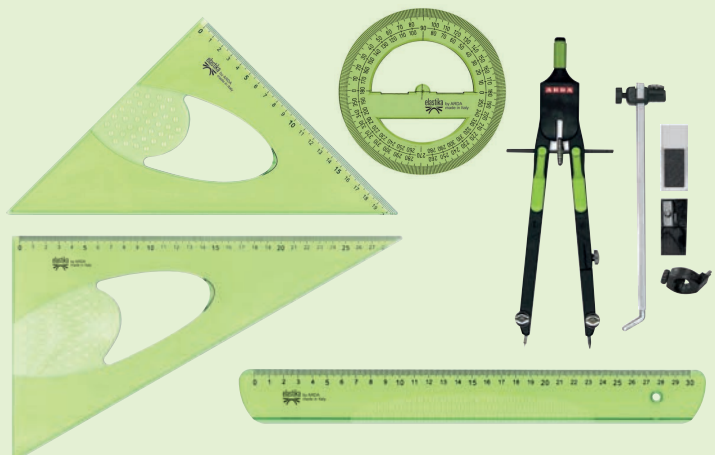

* Album disegno non incluso - Drawing album not included - Papier à dessin non inclus

Valigetta Elastika

Big briefcase with ruler pocket - Mallette avec pochette pour règle

ref.EL5237



EXTRA SIZE
cm.52 x 37



TESSUTO INNOVATIVO IN r-PET

molto robusto ma allo stesso tempo leggero e pratico da pulire. Cuciture e chiusure super resistenti

NEW MATERIAL r-PET

very robust fabric but at the same time light and practical to clean. Super resistant seams and closures.

TISSU INNOVANT r-PET

très robuste mais à la fois léger et pratique à nettoyer. Coutures et fermetures super résistantes



TASCA PORTARIGA 50 / 60 cm.

**INSIDE POCKET FOR RULER
POCHE POUR REGLE**

Art.	EAN13 art.	INNER pcs	EAN13 inner	MASTER pcs
EL5237	8003438032478	2	8003438032485	24

Balaustrone

CON FRIZIONE E PROLUNGA

QUICK-SET COMPASS WITH PUSH BUTTON AND ARM



ASTUCCIO
APRI, PIEGA E DISEGNA!
.....
STAND-UP
FABRIC CASE
OPEN IT, FOLD IT, USE IT !

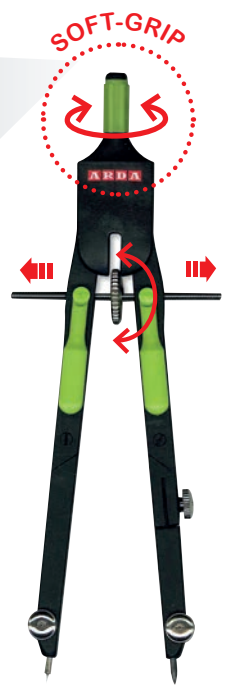

Astuccio stand-up : protegge il compasso e tutti gli accessori. lo apri, lo pieghi e hai tutto a portata di mano !

Stand-up fabric case : save your compass and accessories. open it, fold it and you have everything at your fingertips !

IN DISPLAY 3 pz/pcs

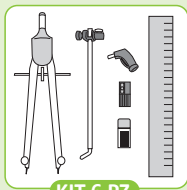

KIT 6 PZ.

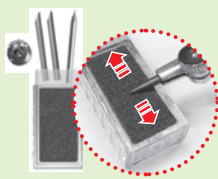

ASTE CON FINITURA SATINATA
RODS WITH SATIN FINISH

Art.	EAN13 art.	Descrizione / Description	INNER	EAN13 inner	MASTER
CO1EL	8003438030672	BALAUSTRONE con frizione e prolunga - kit 6 pz	3	8003438030689	3

Tubo portadisegni

IN NYLON

NYLON TUBES FOR DRAWINGS - TUBES POUR DESSINS EN NYLON

ref. 1572S

Ø 8 cm - lunghezza cm.75



In nylon impermeabile. Tracolla regolabile, maniglia e chiusura con zip.

In waterproof nylon. Adjustable shoulder strap, handle and zip closure.

En nylon imperméable. Bandoulière réglable, poignée et fermeture zippée.



Art.	EAN13 art.	Descrizione / Description	INNER	EAN13 inner	MASTER
1572S	8003438030856	TUBO PORTADISEGNI ELASTIKA col. ass. (4 neri / black / noir + 2 verdi / green / vert)	6	8003438030863	6

METARIGA°

ARDA



semplicemente
geniale!

The ingenious solution that solves the problem of lines sticking out of backpacks and briefcases !
It is precise and maintains all the technical characteristics of a traditional ruler. Protection case.

La solution ingénieuse qui résout le problème des lignes qui dépassent des sacs à dos et des porte-documents !
Précis, conserve les caractéristiques techniques d'une règle traditionnelle inchangées. Emballé dans un étui protective.

La soluzione geniale che risolve il problema delle righe che fuoriescono da zaini e cartelle !
E' precisa e mantiene inalterate tutte le caratteristiche tecniche di una riga tradizionale. Confezionata in custodia protettiva.

Made in Italy

Metariga cm.60
in espositore 12 pz
display 12 pcs - Presentoir 12 pcs

Si piega a metà!

60 cm in metà spazio

Drawing items - Articles de tracage



12 pcs

Ref. MET60ESP
30 x 11 x 48 h. cm

ASTUCCIO
SOFT
TOUCH



Disponibile in display 12 pz (ref.MET60ESP) o in scatola da 6 pz come ricarica (ref.MET60SS)
Available in display 12 pcs (ref.MET60ESP) or box 6 pcs as refill (ref.MET60SS)
Disponibile en display 12 pcs (ref.MET60ESP) ou en carton 6 pcs en recharge (ref.MET60SS)

Art.	EAN13 art.	Descrizione / Description	INNER pcs	EAN13 inner	MASTER pcs
MET60ESP	8003438030702	Espositore 12 pz METARIGA cm.60 (ean pz 8003438 028174)	1	8003438030702	1
MET60SS	8003438028174	METARIGA - Riga cm.60 pieghevole in scatola	6	8003438030696	6

RE-GENERATION

PER UNO SVILUPPO SOSTENIBILE
FOR A SUSTAINABLE DEVELOPMENT

ARDA

Drawing items - Articles de traçage

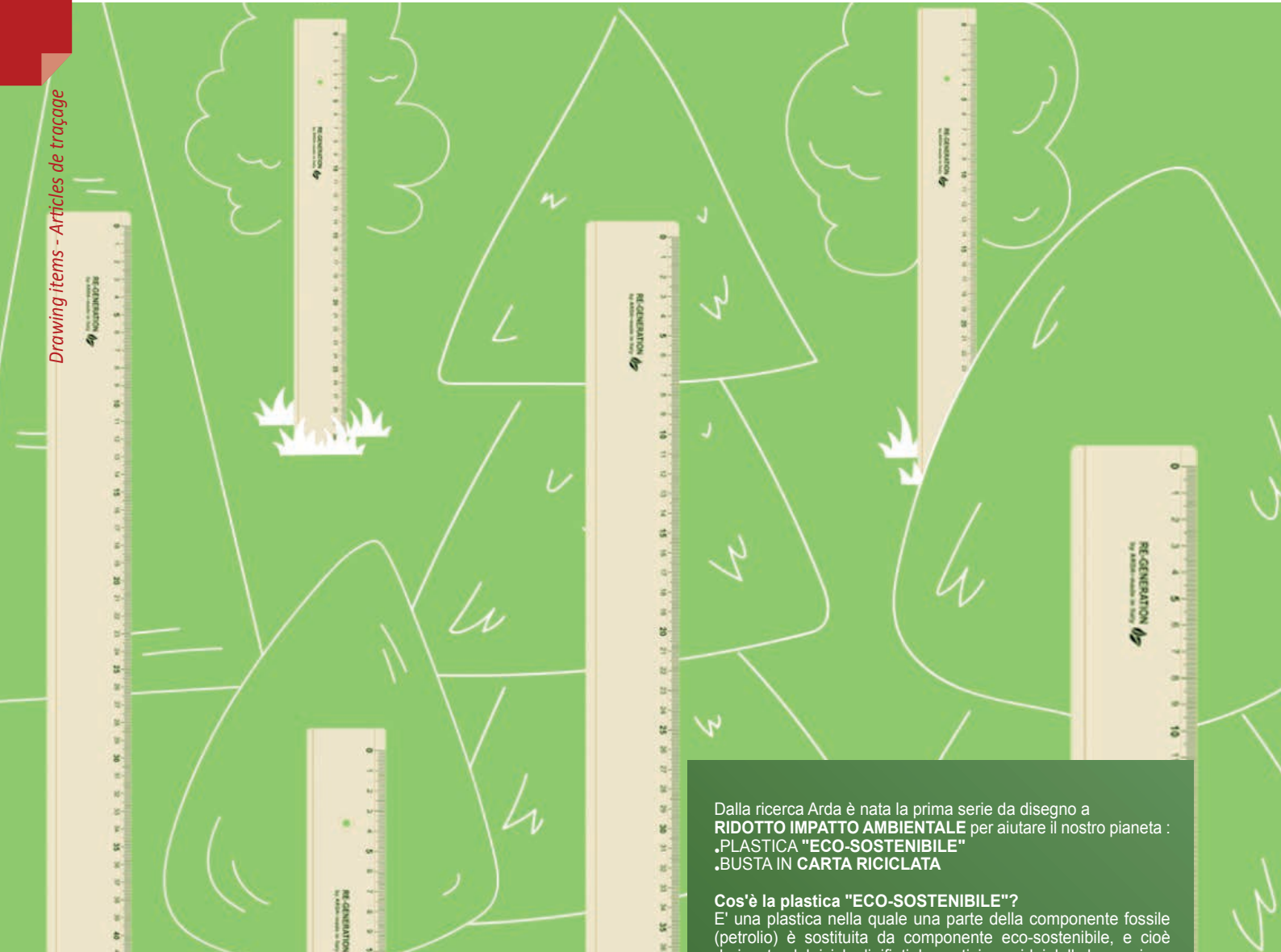

Thanks to ARDA's commitment to environmental issues and deep research, the first drawing line with **REDUCED ENVIRONMENTAL IMPACT** was created to reduce harm to the planet:

- **ECO-SUSTAINABLE** plastic
- **RECYCLED PAPER** bag

What is ECO-SUSTAINABLE PLASTIC?

That is a type of plastic in which a part of the fossil component (oil) is replaced by an eco-sustainable component deriving from the recycling of household waste and woodworking residues.

Benefits of eco SUSTAINABLE PLASTIC

- **100% RECYCLABLE**
- Allows reuse of household waste
- Reduces the use of the fossil component (oil)
- Reduces greenhouse gas emissions by up to 74%
- Preserves agricultural resources because it doesn't involve extensive land exploitation.

L'équipe de recherche d'ARDA a donné naissance à la première gamme de traçage à **IMPACT ENVIRONNEMENTAL RÉDUIT** pour sauvegarder le planète.

- Plastique **ÉCO-RESPONSABLE**
- Emballage en **PAPIER RECYCLÉ**

QU'EST-CE QUE DU PLASTIQUE ÉCO-RESPONSABLE ?

C'est une matière plastique dans laquelle une partie des composés fossiles (issus du pétrole) est substitué par des composés durables issus du recyclage des déchets ménagers et des résidus de la transformation du bois.

Dalla ricerca Arda è nata la prima serie da disegno a **RIDOTTO IMPATTO AMBIENTALE** per aiutare il nostro pianeta :
• **PLASTICA "ECO-SOSTENIBILE"**
• **BUSTA IN CARTA RICICLATA**

Cos'è la plastica "ECO-SOSTENIBILE"?

È una plastica nella quale una parte della componente fossile (petrolio) è sostituita da componente eco-sostenibile, e cioè derivante dal riciclo di rifiuti domestici e residui della lavorazione del legno.

Vantaggi della plastica "ECO-SOSTENIBILE"

- **RICICLABILE AL 100%**
- permette il riutilizzo di rifiuti domestici
- riduce l'utilizzo di materiale di origine fossile (petrolio).
- riduce l'emissione gas serra fino al 74%
- preserva le risorse dell'agricoltura poiché non implica lo sfruttamento intensivo dei terreni.

Made in Italy

LES AVANTAGES DU PLASTIQUE ÉCO-RESPONSABLE

- **RECYCLABLE À 100%**
- Permet la valorisation des déchets domestiques
- Réduit l'utilisation des matériaux fossiles
- Réduction émission de gaz à effet de serre jusqu'à 74%
- Préserve les ressources agricoles puisqu'il n'implique pas l'exploitation intensive des terres cultivables.

Squadre 45° e 60°
Set square 45° and 60°
Equerre 45° et 60°

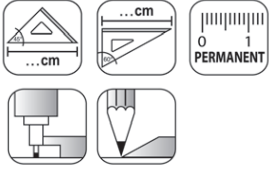

Smusso, tirachina e bordo interno
Bevelled edge, ink-edge and finger lift
Facette, bord anti-tache et bord intérieur

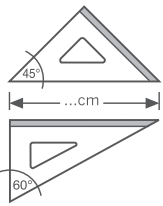

Ref. RE4530

Art.	EAN13 art.	Descrizione / Description	INNER pcs	EAN13 inner	MASTER pcs
RE4530	8003438028020	45° cm. 30	10	8003438028099	10

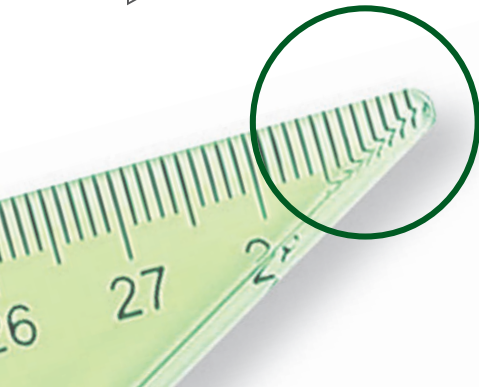

PUNTE ARROTONDATE DI SICUREZZA

ROUND EDGES FOR SECURITY

BOUTS ROUNDS POUR PLUS DE SECURITÉ

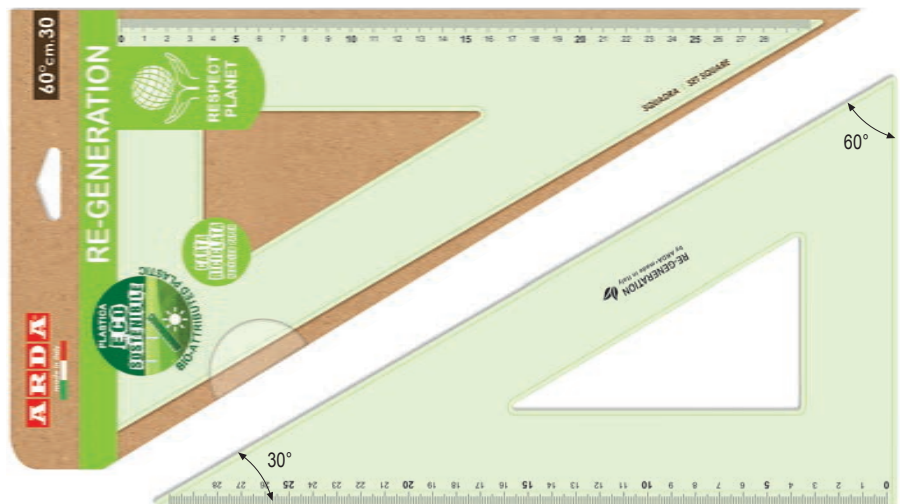

Ref. RE6030

Art.	EAN13 art.	Descrizione / Description	INNER pcs	EAN13 inner	MASTER pcs
RE6030	8003438028037	60° cm. 30	10	8003438028105	10

Goniometro 360°

Protractor 360°
Rapporteur 360°

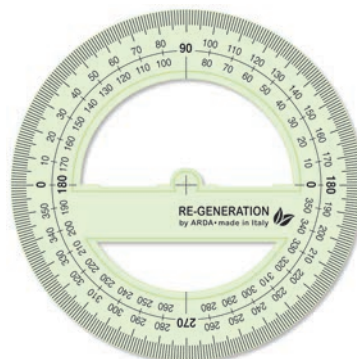

Art.	EAN13 art.	Descrizione	INNER pcs	EAN13 inner	MASTER pcs
RE36012	8003438028068	360°cm.12	10	8003438028136	10

Serie RE-GENERATION

Righe

Rulers - Règles

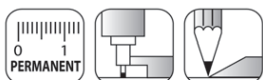

Smusso e tirachina
Bevelled edge and ink-edge
Facette et bord anti-tache



Ref. RE30

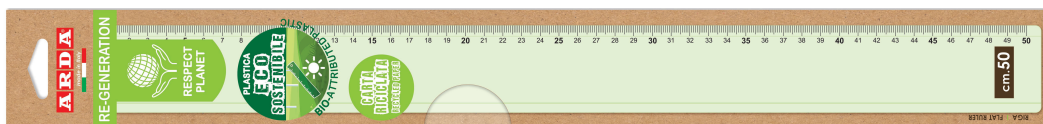

Ref. RE50

Art.	EAN13 art.	Descrizione / Description	INNER pcs	EAN13 inner	MASTER pcs
RE30	8003438028044	cm. 30	10	8003438028112	10
RE50	8003438028051	cm. 50	10	8003438028129	10

Squadra geometrica

Geometric square
Equerre géométrique

45° cm.16

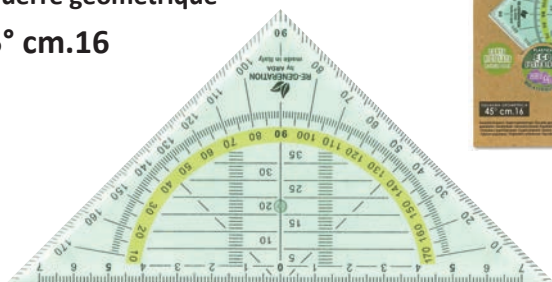

Art.	EAN13 art.	Descrizione	INNER pcs	EAN13 inner	MASTER pcs
REGEO300	8003438028075	45°cm.16	10	8003438028143	200

Barattolo 24 righelli

Pot 24 rulers - Pot de 24 règles

cm.16



Art.	EAN13 art.	Descrizione	INNER pcs	EAN13 inner	MASTER pcs
RE15BAR	8003438028327	cm.16	1	8003438028327	10

Articolo singolo / Each articles / Article à l'unité : 8003438028310



51 pcs

Ref. RE4768

32,5 x 25 x 60 h. cm

Espositore da banco

Counter display - Présentoir de comptoir

51 pz / pcs

Art.	EAN13 art.	Descrizione / Description	INNER	MASTER
RE4768	8003438028167	10x Sq. 45°cm.30 - ref.RE4530 10x Sq. 60°cm.30 - ref. RE6030 10x Righe cm. 30 - ref. RE30 10x Righe cm. 50 - ref. RE50 10x Gon. 360°cm.12 - ref.RE36012 1x bar.24 righelli cm.16 - ref.RE15BAR	1	1

Disponibilità limitata alle campagne promozionali - Product availability limited to promotional campaigns - Disponibilité limitée aux campagnes promotionnelles



NEW



Ref. 500RE

Espositore da terra 200 pz.

Floor display stand 200 pcs - Presentoir au sol 200 pcs

Art.	EAN13 art.	Descrizione / Description	INNER	MASTER
500RE	8003438 028471	40x Sq. 45°cm.30 - ref.RE4530 40x Sq. 60°cm.30 - ref. RE6030 40x Righe cm. 30 - ref. RE30 40x Righe cm. 50 - ref. RE50 40x Gon. 360°cm.12 - ref.RE36012	1	1

Disponibilità limitata alle campagne promozionali - Product availability limited to promotional campaigns - Disponibilité limitée aux campagnes promotionnelles

Ref. 500RE01

Espositore da terra 188 pz.

Floor display stand 188 pcs - Presentoir au sol 188 pcs

Art.	EAN13 art.	Descrizione / Description	INNER	MASTER
500RE01	8003438 030979	RE-GENERATION 20x Sq. 45°cm.30 - ref.RE4530 20x Sq. 60°cm.30 - ref. RE6030 20x Righe cm. 30 - ref. RE30 20x Righe cm. 50 - ref. RE50 20x Gon. 360°cm.12 - ref.RE36012 BLACK is the NEW GREEN 20x Forbice cm.15 - ref.FB15RE 20x Forbice cm.18 - ref.FB18RE 20x Forbice cm.21 - ref.FB21RE 6x Balastrone kit 6 pz - ref.CO2RE 10x Miniset 3 pz - ref. 7063RE 12 x astucci portapenne - ref. 0231REG	1	1

Disponibilità limitata alle campagne promozionali - Product availability limited to promotional campaigns - Disponibilité limitée aux campagnes promotionnelles

Espositore
Display - Presentoir

85 pcs Ref. 1630006
Ean singolo/per item/à l'unité
40 x 24 x 30 h. cm



48x
Righello - Rulers
cm 16



10x
Miniset 3 pz.



24x
Temperamatite
Sharpener
CLACK



3x
Set balastrone
Quick-set compass

Art.	EAN13 art.	Descrizione / Description	INNER pcs	EAN13 inner	MASTER pcs
1630006	8003438029447	Display 85 pz contenente: - n°48 righelli / rulers cm.16 BLACK is the new GREEN - n°10 Miniset BLACK is the new GREEN - n°3 Set balastrone / Quick-set compass BLACK is the new GREEN - n°24 temperamatite / sharpener Clack BLACK is the new GREEN	1	8003438029447	1

Miniset disegno in busta con zip

Drawing miniset in bag with zip
miniset en pochette avec trous

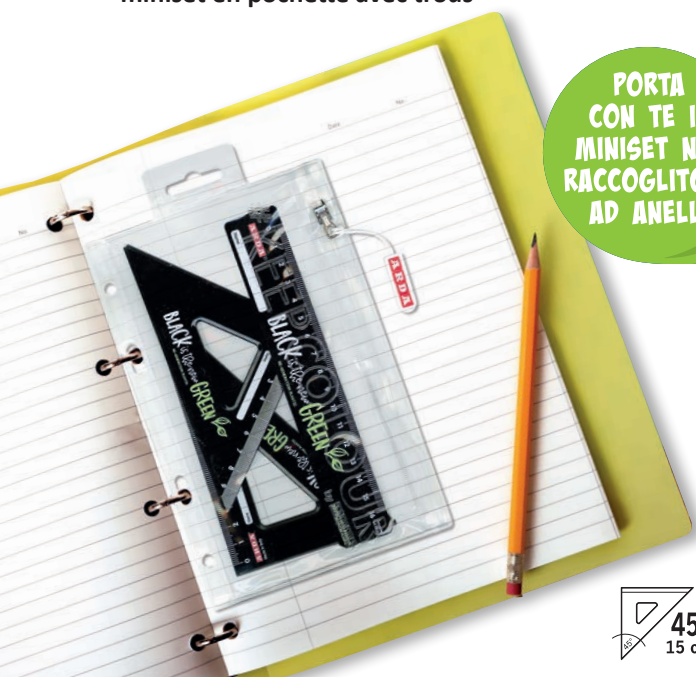

PORTA CON TE IL MINISSET NEL RACCOLTORE AD ANELLI

Foratura universale
Multi punches

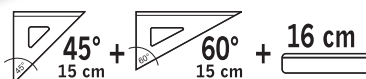

Ref. 7063RE



205 mm

135 mm

Art.	EAN13 art.	Descrizione / Description	INNER pcs	EAN13 inner	MASTER pcs
7063RE	8003438029522	Miniset 3 pz/pcs : 45°cm.15 + 60°cm.15 + R16	10	8003438029539	10

PER DISEGNO TECNICO E SCOLASTICO



In polistirolo di grande trasparenza e durezza superficiale, per garantire resistenza e durata nel tempo. Articoli in colore fumé ottico riposante per gli occhi. Graduazione incisa a caldo con caratteri facilmente leggibili e molto precisi. La maggior parte degli articoli è munita di bordo tira-china sui lati non graduati. Gli articoli sono confezionati in busta appendibile che può essere riutilizzata per proteggere il prodotto da graffi e rotture. Imballo in scatole da 20 pezzi.

FOR TECHNICAL AND SCHOOL USE

Produced using polystyrene with a high level of transparency and surface hardness to guarantee toughness and long-term durability. The articles are in smoky grey, suitable for all types of use. The graduation is heat etched, easy to read and very accurate. Most of the articles are equipped with an inking edge on the non-graduated sides. The articles are packaged in individual pouches with hang tabs which can be re-used to protect the item from scratching and breakage. Packaging in personalised boxes containing 20 pieces.

POUR EMPLOI TECHNIQUE ET SCOLAIRE.

Elle est réalisée en polystyrène d'une transparence très élevée et dureté superficielle qui garantissent résistance et dureté dans le temps. Les articles sont en couleur gris fumé indiqué pour tous les usages. La graduation est gravée à chaud avec des chiffres très clairement lisibles et précis. La plupart des articles est fournie avec un bord antitache sur les côtés non gradués. Les articles sont conditionnés sous pochette accrochable qu'on peut réutiliser pour protéger le produit de rayures et ruptures. Les boîtes sont de 20 pcs. à la marque propre.

Made in Italy

Serie UNI

Squadre 45°

Set square 45° - Equerre 45°

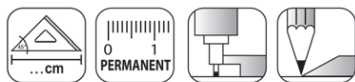

Smusso, tirachina e bordo interno
Bevelled edge, ink-edge and finger lift
Facette, bord anti-tache et bord intérieur

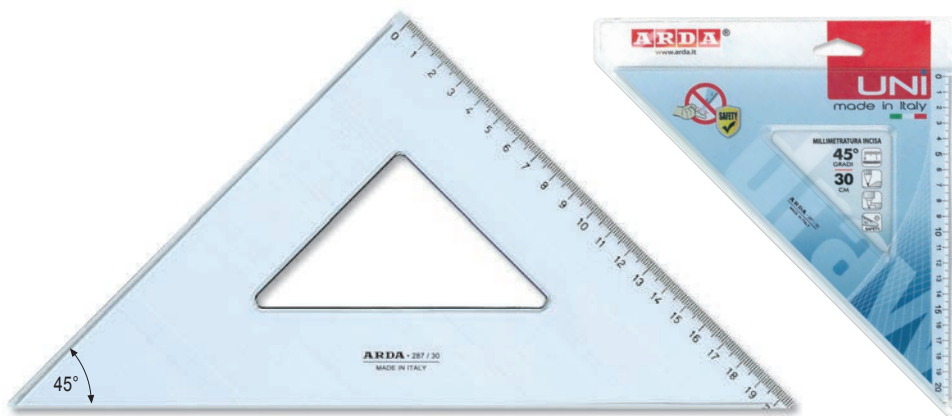

Ref. 28712- 15 - 20 - 25 - 30 - 35 SS

Art.	EAN13 art.	Descrizione / Description	INNER pcs	EAN13 inner	MASTER pcs
28712SS	8003438287120	45° cm. 12	20	8003438487124	500
28715SS	8003438287151	45° cm. 15	20	8003438487155	900
28720SS	8003438287205	45° cm. 20	20	8003438487209	400
28725SS	8003438287250	45° cm. 25	20	8003438487254	300
28730SS	8003438287304	45° cm. 30	20	8003438487308	200
28735SS	8003438287359	45° cm. 35	20	8003438487353	160

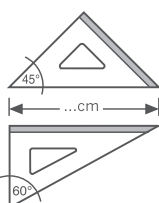

Squadre 60°

Set square 60° - Equerre 60°

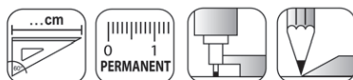

Smusso, tirachina e bordo interno
Bevelled edge, ink-edge and finger lift
Facette, bord anti-tache et bord intérieur

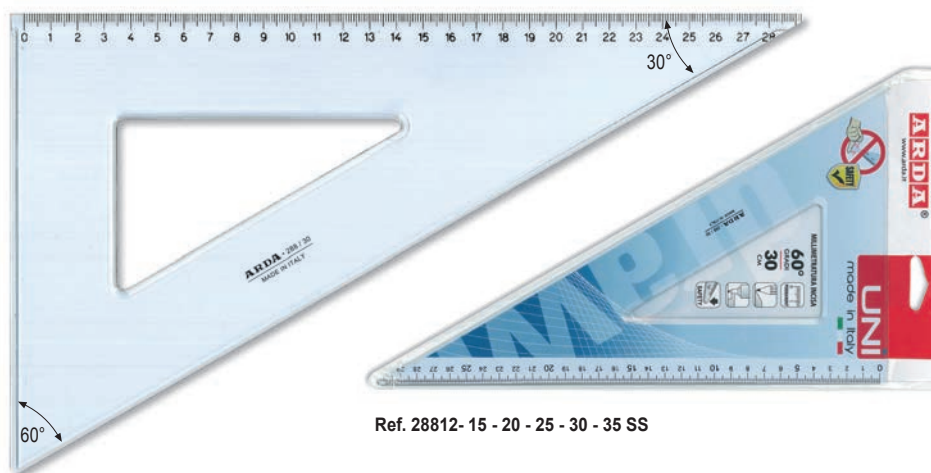

Ref. 28812- 15 - 20 - 25 - 30 - 35 SS

Art.	EAN13 art.	Descrizione / Description	INNER pcs	EAN13 inner	MASTER pcs
28812SS	8003438288127	60° cm. 12	20	8003438488121	500
28815SS	8003438288158	60° cm. 15	20	8003438488152	880
28820SS	8003438288202	60° cm. 20	20	8003438488206	400
28825SS	8003438288257	60° cm. 25	20	8003438488251	260
28830SS	8003438288301	60° cm. 30	20	8003438488305	200
28835SS	8003438288356	60° cm. 35	20	8003438488350	200

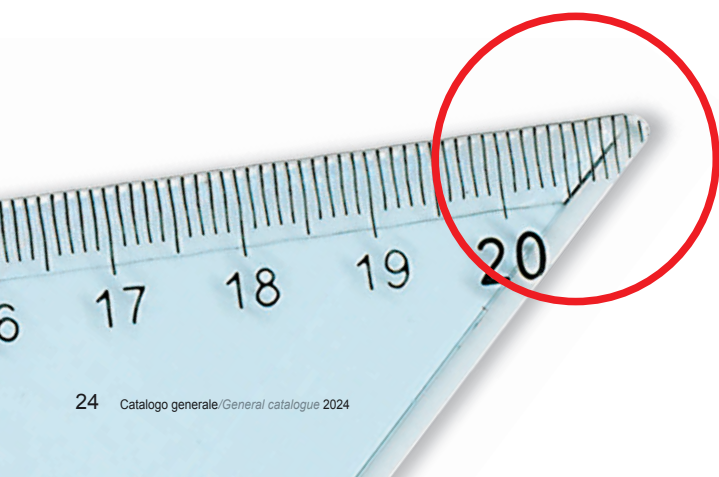

PUNTE ARROTONDATE DI SICUREZZA
ROUND EDGES FOR SECURITY
BOUTS ROUNDS POUR PLUS DE SÉCURITÉ

Righe

Rulers - Règles

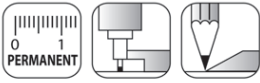

Smusso e tirachina
Bevelled edge and ink-edge
Facette et bord anti-tache



Ref. 28920 - 30 - 40 - 50 - 60 SS ▪ Ref. 28970C - 80C - 100C - 120C

Art.	EAN13 art.	Descrizione / Description	INNER pcs	EAN13 inner	MASTER pcs
28917SS	8003438012937	cm. 17	20	8003438012944	800
28917	8003438289179	cm. 17 sfuso / bulk / vrac	150	8003438228918	150
28920SS	8003438289209	cm. 20	20	8003438489203	700
28930SS	8003438289308	cm. 30	20	8003438489302	400
50030SS	8003438050038	cm. 30 bianco/white/blanc	20	8003438450036	360
28940SS	8003438289407	cm. 40	20	8003438489401	200
28950SS	8003438289506	cm. 50	20	8003438489500	200
28960SS	8003438289605	cm. 60	20	8003438489609	200
* 28970C	8003438289704	cm. 70	10	8003438489708	10
* 28980C	8003438289803	cm. 80	10	8003438489807	10

Cm. 100 e cm. 120 : colore cristallo e materiale flessibile super resistente
crystal color - strong and flexible material / couleur cristal - matière durable et flexible

* 289100C	8003438289100	cm. 100 (colore cristallo)	1	8003438289100	10
* 289120C	8003438026125	cm.120 (colore cristallo)	1	8003438026125	10

* Packaging : busta cellophane

Righe graduazione verticale

Rulers vertical graduation
Règles graduation verticale



Smusso e tirachina
Bevelled edge and ink-edge
Facette et bord anti-tache

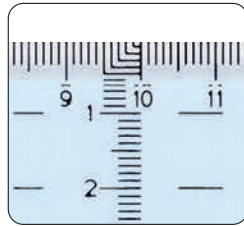

Ref. 28920 - 30 - 40 - 50 GVSS

Art.	EAN13 art.	Descrizione / Description	INNER pcs	EAN13 inner	MASTER pcs
28920GVSS	8003438289216	cm. 20	20	8003438489210	700
28930GVSS	8003438289315	cm. 30	20	8003438489319	400
28940GVSS	8003438289414	cm. 40	20	8003438489418	200
28950GVSS	8003438289513	cm. 50	20	8003438489517	200

Righelli quadri

Square rulers
Règles carrée



Ref. 77 15 cm ■ 7x7 mm



Ref. 50230C 30 cm ■ 8x12 mm

Art.	EAN13 art.	Descrizione / Description	INNER pcs	EAN13 inner	MASTER pcs
77	8003438770004	cm. 15 - mm. 7x7	250	8003438077004	250
50230C	8003438502308	cm. 30 - mm. 8x12	20	8003438450234	360

Decimetro Ruler 10cm - Décimètre

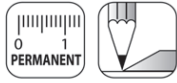

**Doppia graduazione
Double graduation
mm / inch**

Ref. 280C

Art.	EAN13 art.	Descrizione / Description	INNER pcs	EAN13 inner	MASTER pcs
280C	8003438002808	Decimetro - 10 cm	20	8003438202802	500

Drawing items - Articles de traçage

Doppio e triplo decimetro

Finger grip ruler 20 and 30 cm
Double et triple décimètre

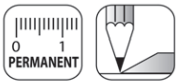

impugnatura corta • short grip • poignée courte Ref. 283SS

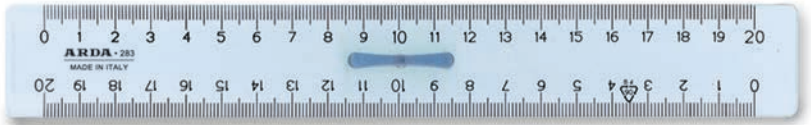

impugnatura lunga • long grip • poignée longue Ref. 286SS

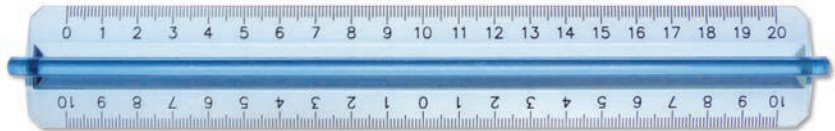

impugnatura lunga • long grip • poignée longue Ref. 50130SS

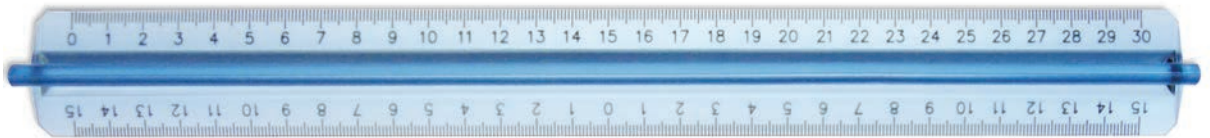

Art.	EAN13 art.	Descrizione / Description	INNER pz/pcs	EAN13 inner	MASTER pz/pcs
283SS	8003438002839	20 cm - impugnatura corta/short grip/poignée courte	20	8003438022837	300
286SS	8003438002860	20 cm - impugnatura lunga/long grip/poignée longue	20	8003438028600	240
50130SS	8003438005014	30 cm - impugnatura lunga/long grip/poignée longue	20	8003438025012	160

Goniometri 180°

Protractor 180°
Rapporteur 180°

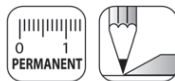

Smusso e bordo interno
Bevelled edge and finger lift
Facette et bord intérieur



Ref. 294SS
Con decimetro
With ruler 10 cm - Avec décimètre

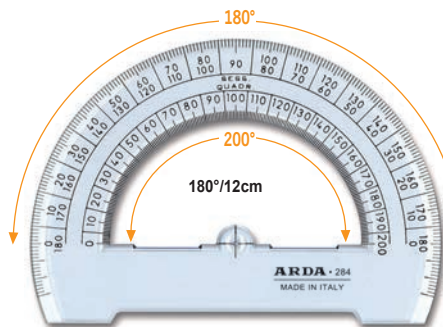

Ref. 284SS



Ref. 296SS



Art.	EAN13 art.	Descrizione / Description	INNER pcs	EAN13 inner	MASTER pcs
294SS	8003438002945	180° cm.10 con decim.	20	8003438212948	900
284SS	8003438002846	180° cm.12	20	8003438212849	660
296SS	8003438002969	180° cm.15	20	8003438202963	20

Goniometri 360°

Protractor 360° - Rapporteur 360°

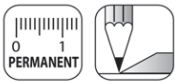

Smusso e bordo interno
Bevelled edge and finger lift
Facette et bord intérieur

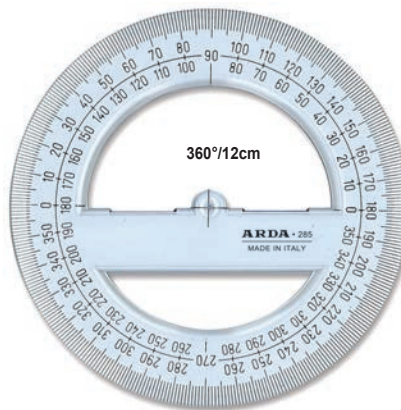

Ref. 285SS

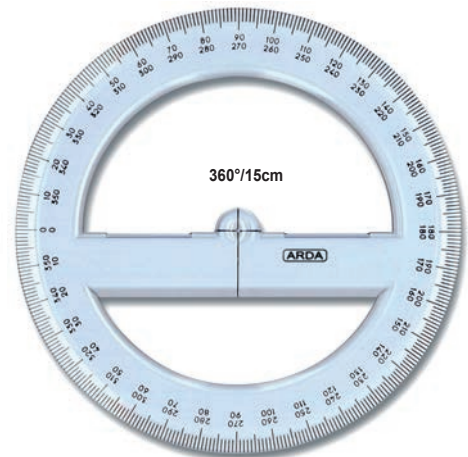

Ref. 297SS

Art.	EAN13 art.	Descrizione / Description	INNER pcs	EAN13 inner	MASTER pcs
285SS	8003438002853	360° cm.12	20	8003438212856	480
297SS	8003438002976	360° cm.15	20	8003438202970	360

Curvilinee

French curves
Set de 3 pistolets



Con doppio tirachina
With double ink-edge
Double bord anti-tache



Ref. 29012

Art.	EAN13 art.	Descrizione / Description	INNER pcs	EAN13 inner	MASTER pcs
29012	8003438290120	Set 3 pz curvilinee/french curves/pistolets	10	8003438229014	190

Espositore

Display - Présentoir

200
pcs

Ref. 4765

39,5 x 19 x 63 h. cm

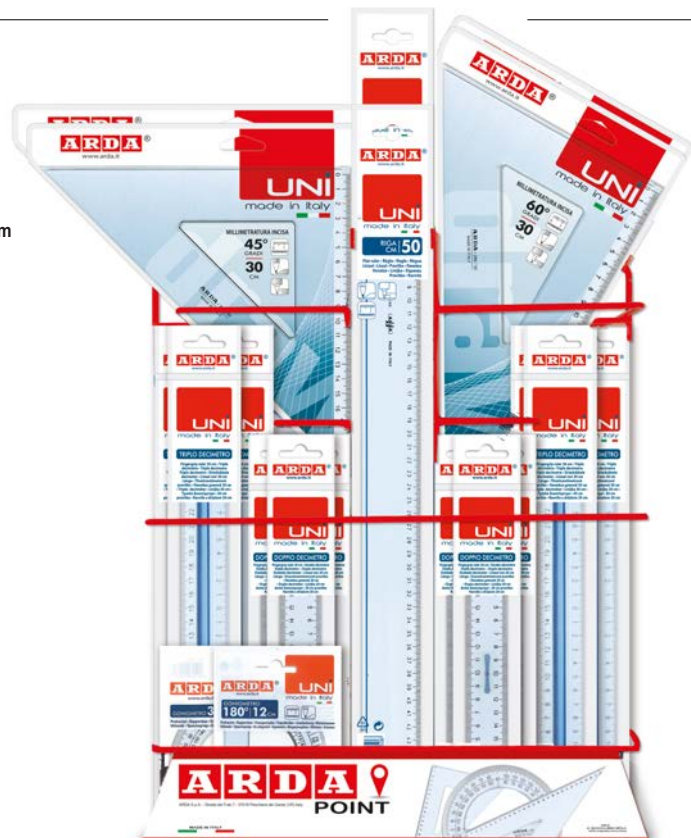

DISPLAY 200 pz / pcs

Art.	EAN13 art.	Descrizione / Description	INNER	MASTER
4765	8003438047656	20x Sq. 45° cm. 30 20x Sq. 60° cm. 30 20x Sq. 45° cm. 35 20x Sq. 60° cm. 35 20x Righe cm. 50 20x Righe cm. 60 20x Doppio dec. cm. 20 20x Triplo dec. cm. 30 20x Gon. 180° cm. 12 20x Gon. 360° cm. 12	1	1

Disponibilità limitata alle campagne promozionali - Product availability limited to promotional campaigns - Disponibilité limitée aux campagnes promotionnelles

Righe T

T-squares - Règle à "T"

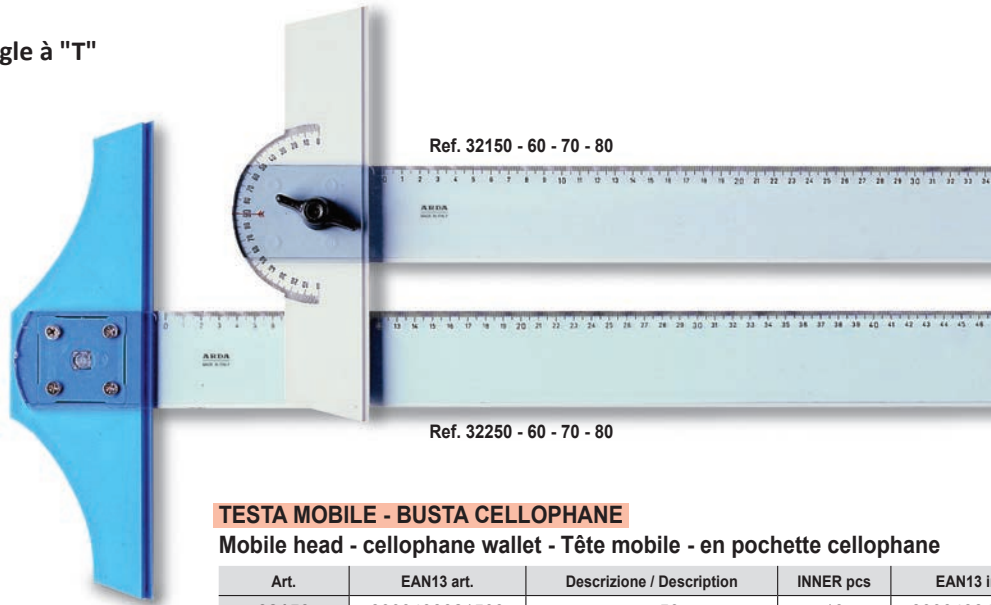

TESTA MOBILE - BUSTA CELLOPHANE

Mobile head - cellophane wallet - Tête mobile - en pochette cellophane

Art.	EAN13 art.	Descrizione / Description	INNER pcs	EAN13 inner	MASTER pcs
32150	8003438321503	cm. 50	10	8003438432155	10
32160	8003438321602	cm. 60	10	8003438432162	10
32170	8003438321701	cm. 70	10	8003438432179	10
32180	8003438321800	cm. 80	10	8003438432186	10

TESTA FISSA - BUSTA CELLOPHANE

Fixed head - cellophane wallet - Tête fixe en pochette cellophane

Art.	EAN13 art.	Descrizione / Description	INNER pcs	EAN13 inner	MASTER pcs
32250	8003438322500	cm. 50	10	8003438432254	10
32260	8003438322609	cm. 60	10	8003438432261	10
32270	8003438322708	cm. 70	10	8003438432278	10
32280	8003438322807	cm. 80	10	8003438432285	10

Righe parallele

Parallel rulers
Règles parallèles



Ref. 325SC

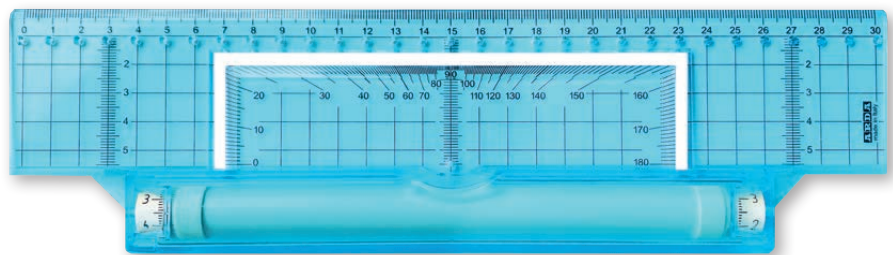

Art.	EAN13 art.	Descrizione / Description	INNER pcs	EAN13 inner	MASTER pcs
325SC	8003438325006	cm.30	1	8003438325006	5

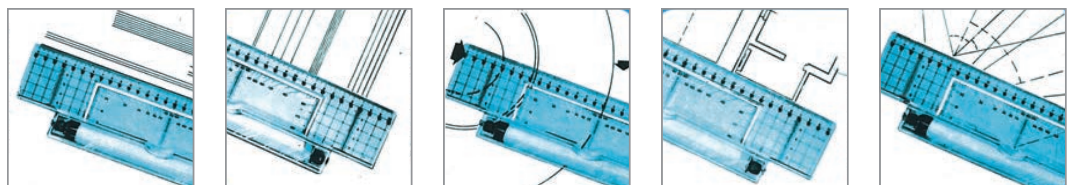

Coppia squadre

Set of 2 squares
Couple 2 équerres

ref. 70312SS
ref.70315SS

ref. 70330SS
ref.70335SS

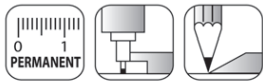

Smusso, tirachina e bordo interno
Bevelled edge, ink-edge and finger lift
Facette, bord anti-tache et bord intérieur



- Punta arrotondate di sicurezza
- Round edges for security
- Bouts ronds pour plus de sécurité

Art.	EAN13 art.	Descrizione / Description	INNER pcs	EAN13 inner	MASTER pcs
70312SS	8003438703125	45° + 60° cm. 12	20	8003438723123	20
70315SS	8003438703156	45° + 60° cm. 15	20	8003438723154	20
70330SS	8003438703309	45° + 60° cm. 30	20	8003438723307	20
70335SS	8003438703354	45° + 60° cm. 35	20	8003438723352	20

Set disegno 4 pz

Drawing set 4 pcs
Set de traçage 4 pcs

Ref. 705

Ref. 70420SS - ref. 70430SS

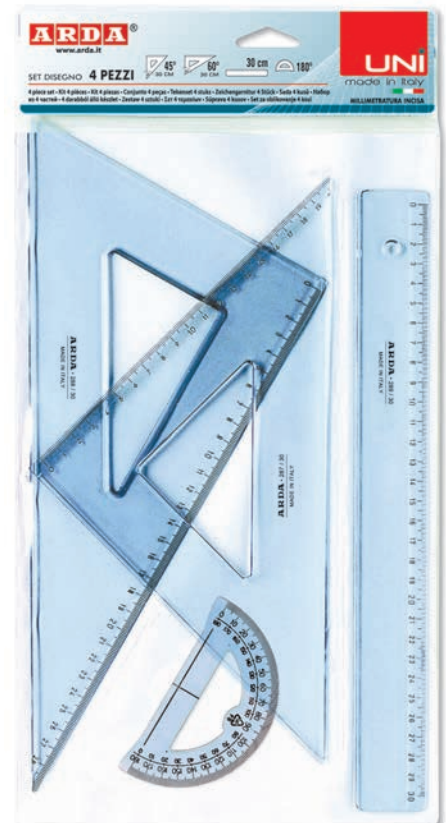
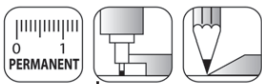

* eccetto goniometro
except protractor - sauf que rapporteur

Smusso, tirachina e bordo interno
Bevelled edge, ink-edge and finger lift
Facette, bord anti-tache et bord intérieur

Art.	EAN13 art.	Descrizione / Description	INNER pcs	EAN13 inner	MASTER pcs
705	8003438705006	Miniset: 45° - 60° cm.15 - R20 - 180°/10cm	20	8003438725004	20
70420SS	8003438704207	Set 4 pz/pcs: 45° - 60° cm.20 - R20 180°/10cm	10	8003438724205	10
70430SS	8003438704306	Set 4 pz/pcs: 45° - 60° cm.30 - R30 180°/10cm	20	8003438724304	20

SQUADRE GEOMETRICHE - GEOMETRIC SQUARE - EQUERRE GÉOMETRIQUE

4 FUNZIONI IN 1
4 fonctions in 1 - 4 usages en 1

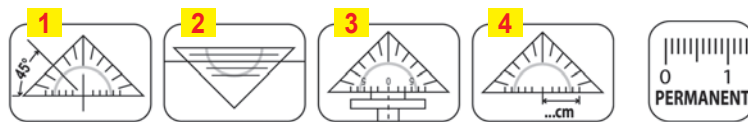

SENZA IMPUGNATURA - Without grip - Sans poignée
45°cm 16

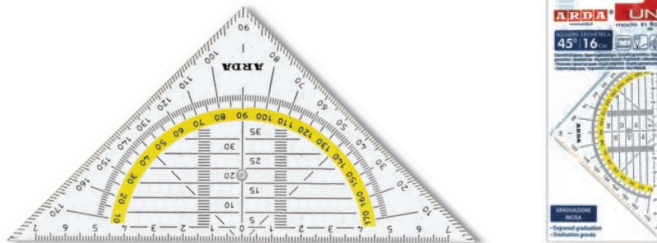

Ref. GEO300SS

Art.	EAN13 art.	Descrizione / Description	INNER pcs	EAN13 inner	MASTER pcs
GEO300SS	8003438003003	45° cm. 16 senza impugnatura	20	8003438413000	1000

CON IMPUGNATURA FISSA - Fixed grip - Poignée fixée
45°cm 25

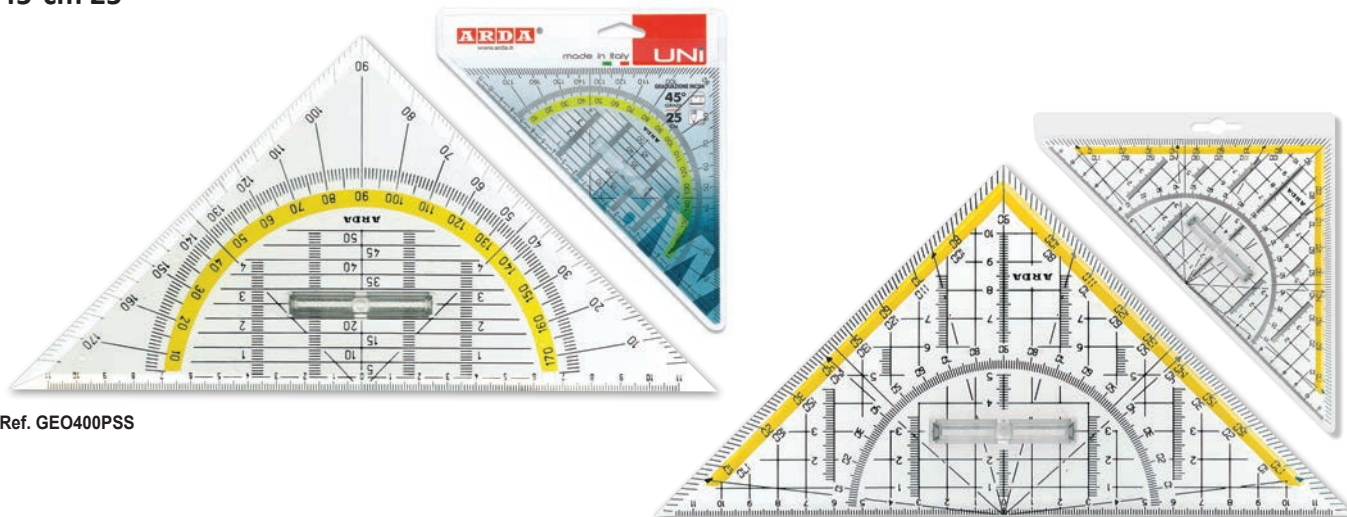

Ref. GEO400PSS

Ref. GEO400PQSS Quadrettata - With squared surface - Avec quadrillée

Art.	EAN13 art.	Descrizione / Description	INNER pcs	EAN13 inner	MASTER pcs
GEO400PSS	8003438014009	45° cm. 25 impugnatura fissa	10	8003438414007	10
GEO400PQSS	8003438008299	45° cm. 25 impugnatura fissa+quadrettatura	10	8003438008305	10

CON IMPUGNATURA REMOVIBILE - With removable grip - Avec poignée amovibile
45°cm 25

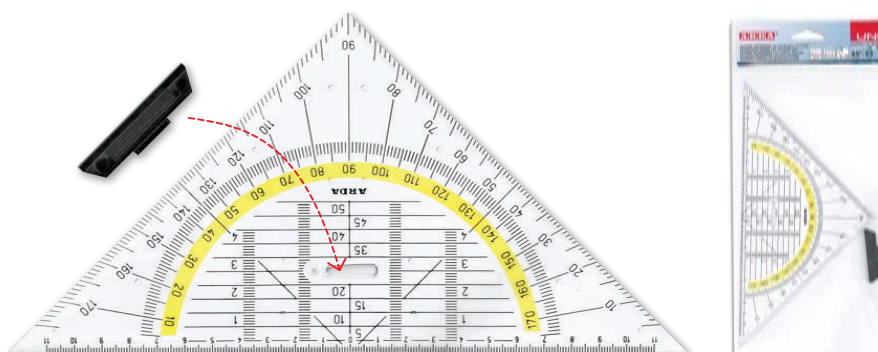

Ref. GEO401PSS

Art.	EAN13 art.	Descrizione / Description	INNER pcs	EAN13 inner	MASTER pcs
GEO401PSS	8003438024008	45° cm. 25 imp.removibile	10	8003438032140	100

Righelli in plastica per l'astuccio



Barattolo righelli 17 cm modello largo

Pot containing rulers - large
Pot de règles - larges

Ean singolo per item à l'unité



FLUO
colours

Ref. 28917BAR

30
pcs

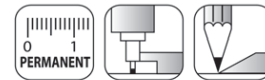

Art.	EAN13 art. 8003438...	INNER pz/pcs	EAN13 inner 8003438...	MASTER pz/pcs
28917BAR	...289186	1	...289186	20

colori assortiti - assorted colours - couleurs assorties
Articolo singolo / Each articles / Article à l'unité : 8003438 016539

Barattolo righelli 15 cm modello stretto

Pot containing rulers - narrow
Pot de règles - étroites

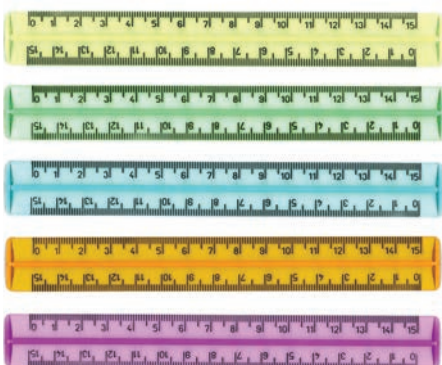

50
pcs

Ref. 282C

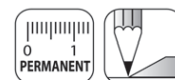

Art.	EAN13 art. 8003438...	INNER pz/pcs	EAN13 inner 8003438...	MASTER pz/pcs
282C	...002822	1	...002822	20

colori assortiti - assorted colours - couleurs assorties

**Barattolo righelli 15 cm
modello stretto**

Pot containing rulers - narrow
Pot de règles - étroites



FLUO
colours

50
pcs

Ref. 282FL

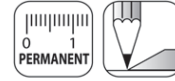

Art.	EAN13 art. 8003438...	INNER pz/pcs	EAN13 inner 8003438...	MASTER pz/pcs
282FL	...026101	1	...026101	20

colori assortiti - assorted colours - couleurs assorties

Barattolo doppi decimetri

Pot containing finger grip rulers 20 cm
Pot de double décimètre

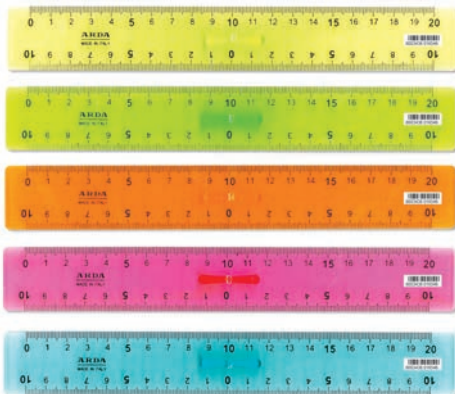
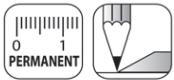

FLUO
colours

10
pcs

Ref. 283BAR



Art.	EAN13 art. 8003438...	INNER pz/pcs	EAN13 inner 8003438...	MASTER pz/pcs
283BAR	...012838	1	...012838	10

colori assortiti - assorted colours - couleurs assorties

Articolo singolo / Each articles / Article à l'unité : 8003438 016546

ECCELLENTE RAPPORTO QUALITÀ / PREZZO.

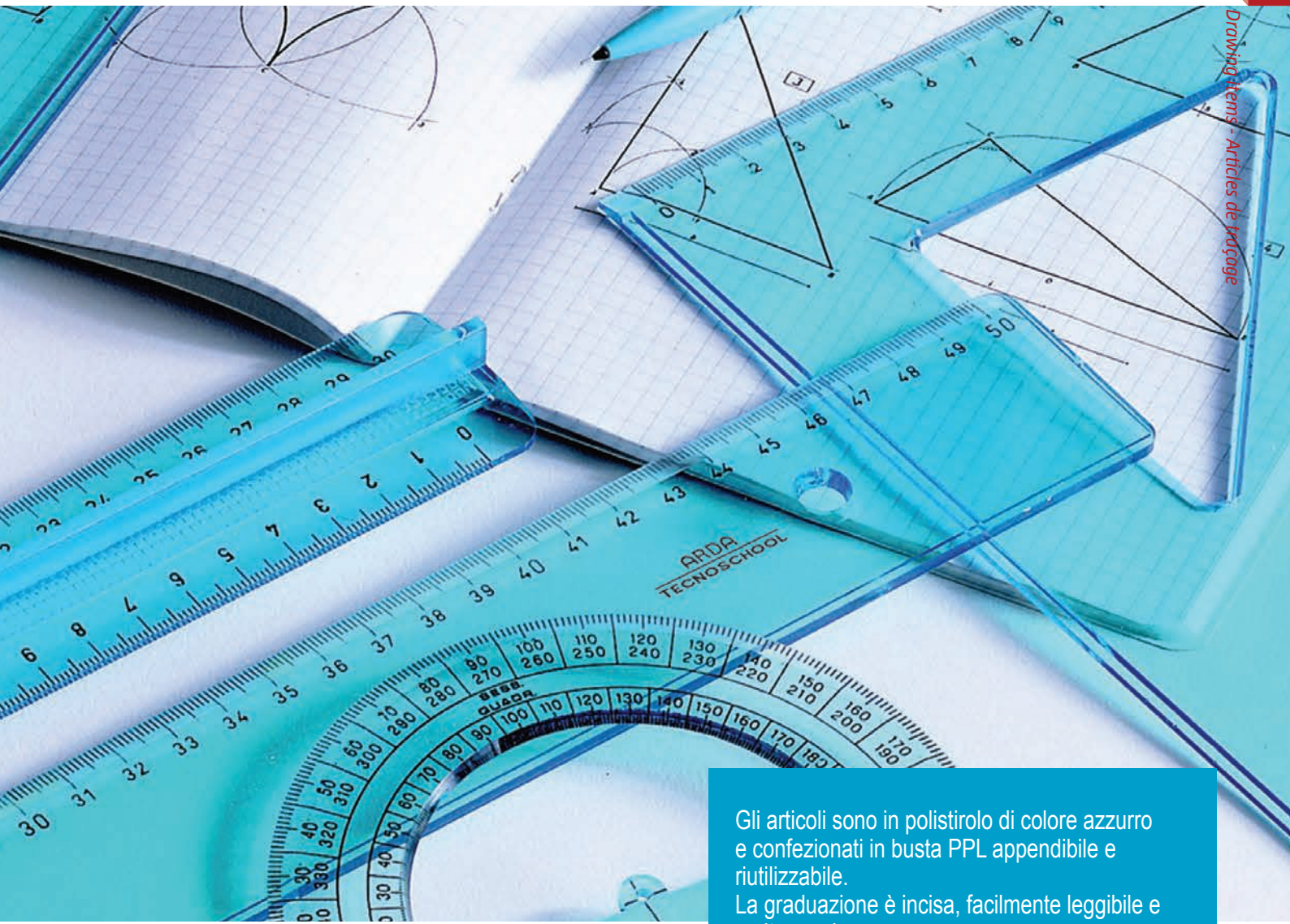

Drawing Items - Articles de Prologue

Gli articoli sono in polistirolo di colore azzurro e confezionati in busta PPL appendibile e riutilizzabile. La graduazione è incisa, facilmente leggibile e molto precisa.

EXCELLENT VALUE FOR MONEY.

The articles are made of polystyrene, blue colour and packaged individually in a reusable PPL wallet with hang tab. Etched easy-to-read graduation with a high level of accuracy.

UN RAPPORT EXCELLENT ENTRE PRIX ET QUALITÉ.

Les articles sont en polystyrène en couleur bleu et en pochette PPL accrochable et réutilisable. La graduation est gravée à chaud avec un standard de précision et lisibilité très élevé.

Made in Italy

Squadre

Set square - Equerre

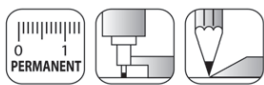

Smusso, tirachina e bordo interno
Bevelled edge, ink-edge and finger lift
Facette, bord anti-tache et bord intérieur

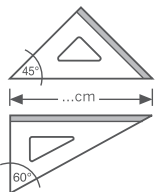

Ref. 40115 - 20 - 25 - 30 - 35 SS

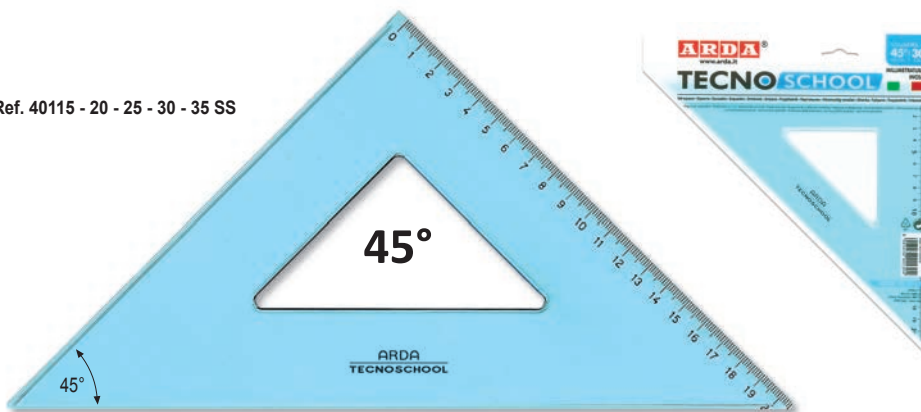

Art.	EAN13 art.	Descrizione / Description	INNER pcs	EAN13 inner	MASTER pcs
40115SS	8003438401151	45° cm. 15	20	8003438421159	900
40120SS	8003438401205	45° cm. 20	20	8003438421203	400
40125SS	8003438401250	45° cm. 25	20	8003438421258	300
40130SS	8003438401304	45° cm. 30	20	8003438421302	200
40135SS	8003438401359	45° cm. 35	20	8003438421357	160



**PUNTE ARROTONDATE
DI SICUREZZA**

**ROUND EDGES FOR
SECURITY**

**BOUITS ROND
PLUS DE SECURITÉ**

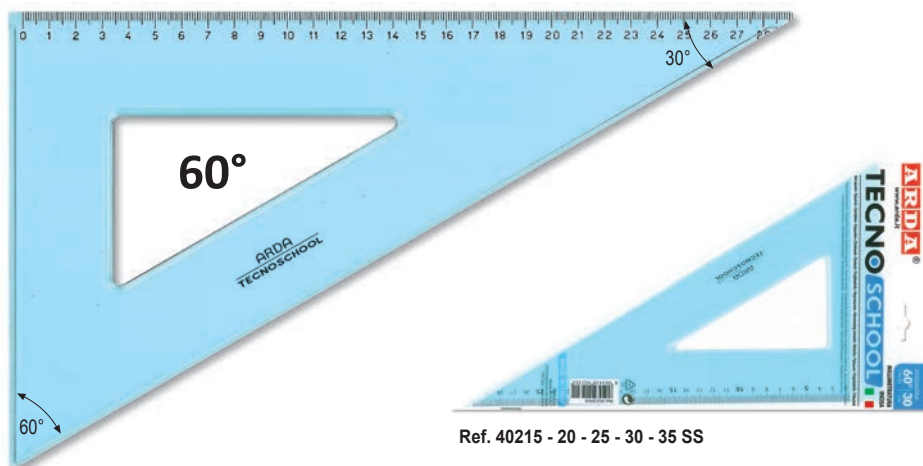

Ref. 40215 - 20 - 25 - 30 - 35 SS

Art.	EAN13 art.	Descrizione / Description	INNER pcs	EAN13 inner	MASTER pcs
40215SS	8003438402158	60° cm. 15	20	8003438422156	880
40220SS	8003438442208	60° cm. 20	20	8003438422200	400
40225SS	8003438402257	60° cm. 25	20	8003438422255	260
40230SS	8003438402301	60° cm. 30	20	8003438422309	200
40235SS	8003438402356	60° cm. 35	20	8003438422354	200

Righe

Rulers - Règles

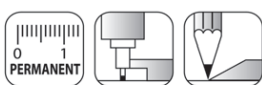

Smusso e tirachina
Bevelled edge and ink-edge
Facette et bord anti-tache

Ref. 40020 - 30 - 40 - 50 - 60 SS

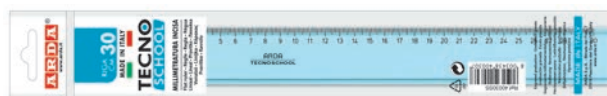

Art.	EAN13 art.	Descrizione / Description	INNER pcs	EAN13 inner	MASTER pcs
40020SS	8003438400208	cm. 20	20	8003438420206	700
40030SS	8003438400307	cm. 30	20	8003438420305	400
40040SS	8003438400406	cm. 40	20	8003438420404	200
40050SS	8003438400505	cm. 50	20	8003438420503	200
40060SS	8003438400604	cm. 60	20	8003438420602	200

Doppio e Triplo decimetro

Finger grip ruler 20-30cm
Double e triple décimètre

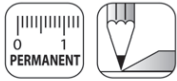

2 millimetrature. Impugnatura corta.
2 graduations. Short grip.
2 graduations. Poignée corte.

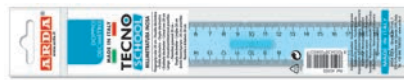

Ref. 403SS

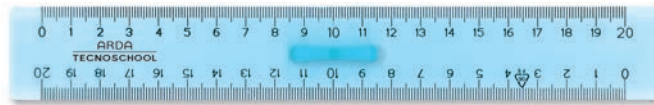

Ref. 406SS



Art.	EAN13 art.	Descrizione / Description	INNER pcs	EAN13 inner	MASTER pcs
403SS	8003438004031	cm. 20	20	8003438104038	300
406SS	8003438004062	cm. 30	20	8003438104069	160

Goniometri

Protractor - Rapporteur

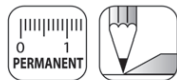

Smusso e bordo interno
Bevelled edge and finger lift
Facette et bord intérieur

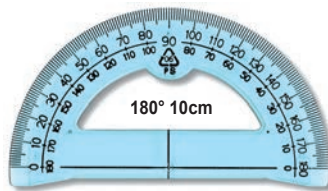

Ref. 404SS

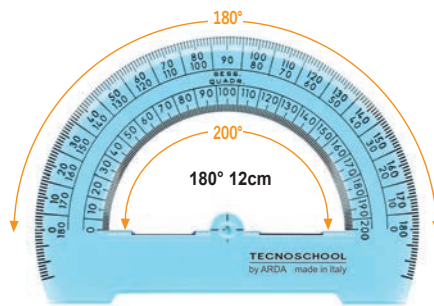

Ref. 407SS

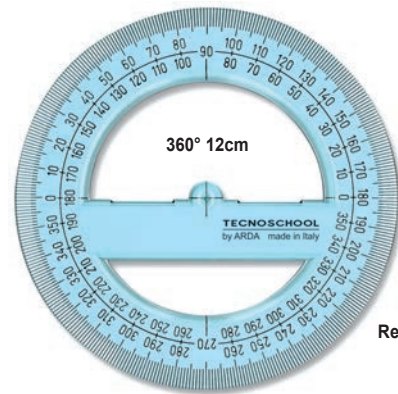

Ref. 405SS



Art.	EAN13 art.	Descrizione / Description	INNER pcs	EAN13 inner	MASTER pcs
404SS	8003438004048	180° cm.10	20	8003438104045	900
407SS	8003438004079	180° cm.12	20	8003438104076	660
405SS	8003438004055	360° cm.12	20	8003438104052	480

Curvilinee

French curves - Set de 3 pistolets



Con doppio tirachina
With double ink-edge
Double bord anti-tache

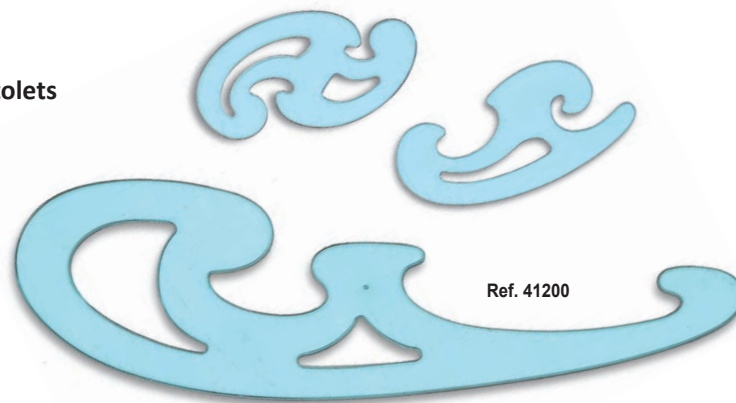

Ref. 41200



Art.	EAN13 art.	Descrizione / Description	INNER pcs	EAN13 inner	MASTER pcs
41200	8003438412003	Set 3 pz curvilinee/french curves/pistolets	10	8003438412027	190

Set disegno

Drawing set
Set de traçage

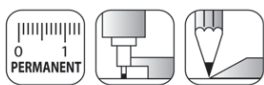

* eccetto goniometro
except protractor
sauf que rapporteur

Smusso, tirachina e bordo interno

Bevelled edge, ink-edge and finger lift

Facette, bord anti-tache et bord intérieur



Ref. 7063
MINISET 3 PZ



Ref. 706
MINISET 4 PZ



Ref. 60430SS
SET 4 PZ

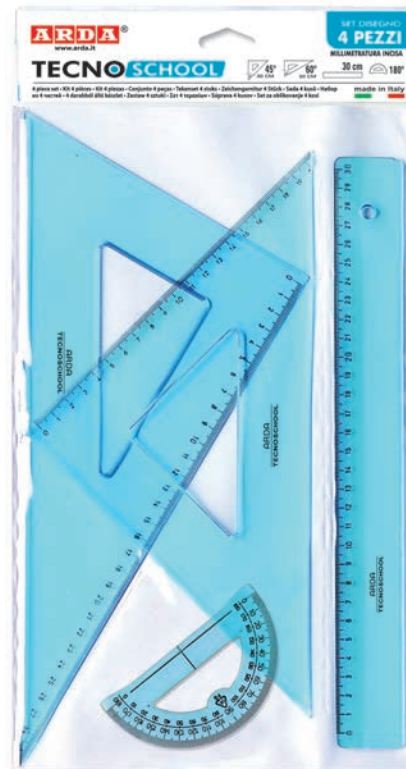

Art.	EAN13 art.	Descrizione / Description	INNER pz/pcs	EAN13 inner	MASTER pz/pcs
706	8003438706003	Miniset 4 pz: 45°- 60° cm.15 - R20 - 180°/10cm	20	8003438726001	20
7063	8003438013835	Miniset 3 pz: 45°- 60° cm.15 - R17	20	8003438013842	20
60430SS	8003438604309	Set 4 pz/pcs: 45°- 60° cm.30 - R30 180°/10cm	20	8003438624307	20

ref. 60330SS
ref. 60335SS

Coppia Squadre

Set of 2 squares - Pochette 2 équerres

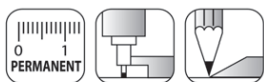

Smusso, tirachina e bordo interno

Bevelled edge, ink-edge and finger lift

Facette, bord anti-tache et bord intérieur



Art.	EAN13 art.	Descrizione / Description	INNER pz/pcs	EAN13 inner	MASTER pz/pcs
60330SS	8003438603302	45° + 60°cm. 30	20	8003438623300	20
60335SS	8003438603357	45° + 60°cm. 35	20	8003438623355	20

Espositore
Display - Presentoir



Contenuto specifico per disegno tecnico su fogli A3

Specific content for technical drawing on A3 sheets

Contenu spécifique pour le dessin technique sur papier A3

200
pcs

Ref. 6640
39.5 x 19 x 63 h. cm

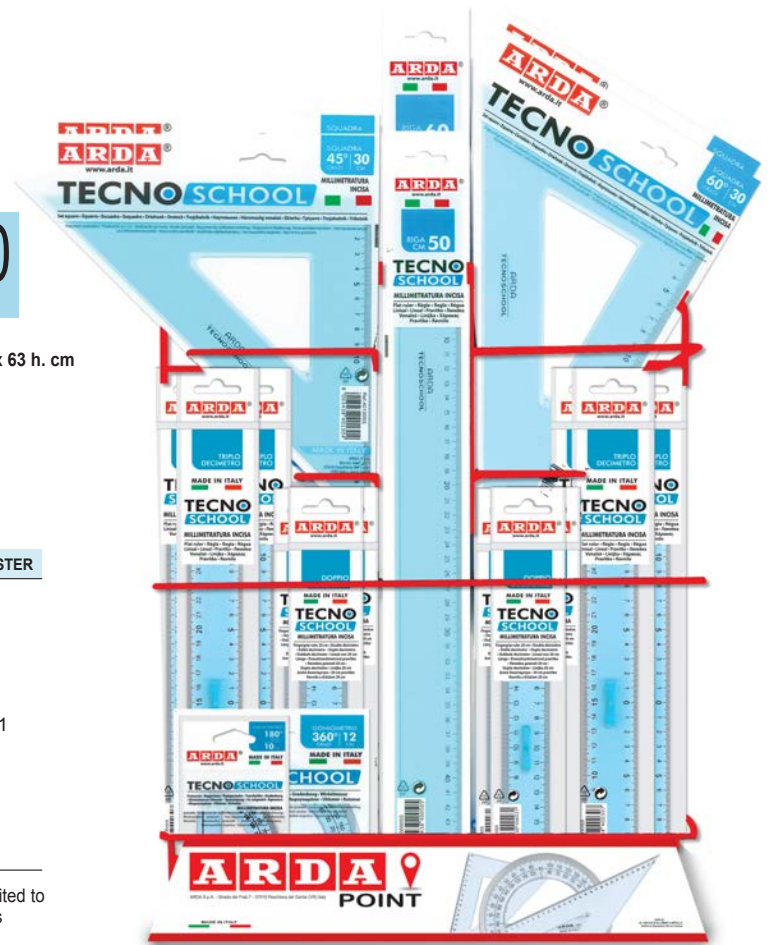

DISPLAY 200 pz / pcs

Art.	EAN13 art.	Descrizione / Description	INNER	MASTER
6640	8003438664006	20x Sq. 45° cm. 30 20x Sq. 60° cm. 30 20x Sq. 45° cm. 35 20x Sq. 60° cm. 35 20x Righe cm. 50 20x Righe cm. 60 20x Doppio dec. cm. 20 20x Triplo dec. cm. 30 20x Gon. 180° cm. 10 20x Gon. 360° cm. 12	1	1

Disponibilità limitata alle campagne promozionali - Product availability limited to promotional campaigns - Disponibilité limitée aux campagnes promotionnelles

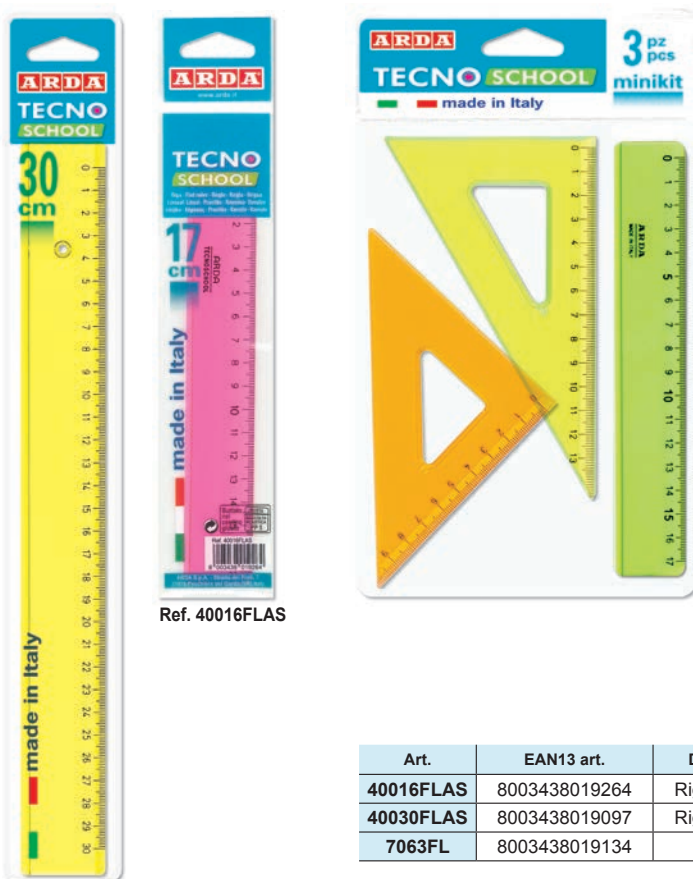

Ref. 40016FLAS

Ref. 40030FLAS

FLUO
colours



Ref. 7063FL
Miniset 3 pz/pcs :
+ 45° 15cm
+ 60° 15cm
+ Riga 17 cm

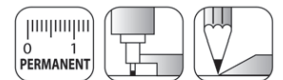

Colori assortiti
assorted colours - couleurs assorties

Art.	EAN13 art.	Descrizione / Description	INNER pz/pcs	EAN13 inner	MASTER pz/pcs
40016FLAS	8003438019264	Riga / Ruler / Règle cm.17	20	8003438019271	800
40030FLAS	8003438019097	Riga / Ruler / Règle cm.30	20	8003438019165	20
7063FL	8003438019134	Miniset 3 pz./pcs	20	8003438019196	20

Righe sfuse

Rulers in bulk - Règles en vrac

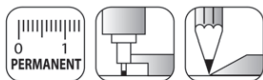

Ref. S10120X



Ref. S10130X

Art.	EAN13 art.	Descrizione / Description	INNER pcs	EAN13 inner	MASTER pcs
S10120X	8003438002426	cm. 20	50	8003438013668	2000
S10130X	8003438002402	cm. 30	50	8003438013675	1000

Drawing items - Articles de traçage

Set 4 pezzi

Drawing set - 4 pcs

Set de traçage - 4 pcs

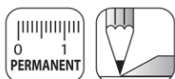

Ref. 60420BIS

Art.	EAN13 art.	Descrizione / Description	INNER pcs	EAN13 inner	MASTER pcs
60420BIS	8003438604200	Set 4 pz : 45° 21 cm + 60° 21 cm+ R30 cm + 180° 10 cm	50	8003438009432	50

Mini-set 4 pezzi

Drawing miniset - 4 pcs

Miniset de traçage - 4 pcs

Ref. 704/12/4BL

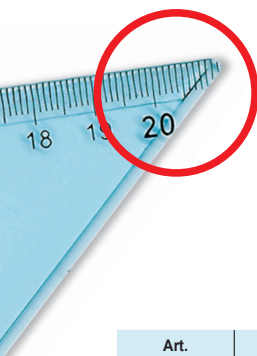

**PUNTE ARROTONDATE
DI SICUREZZA**

**ROUND EDGES FOR
SECURITY**

**BOUITS RONDS POUR
PLUS DE SECURITÉ**

Art.	EAN13 art.	Descrizione / Description	INNER pcs	EAN13 inner	MASTER pcs
704/12/4BL	8003438001924	MINI PICKITUP set 4 pz : 45°/12 cm + 60° 12cm + R15 + 180° 10 cm	25	8003438031617	300

Colori assortiti - Assorted colours - Couleurs assorties

Pickitup flex

ARDA

DISEGNO

Drawing items - Articles de tracage



**INFRANGIBILE
SHATTERPROOF
INCASSABLE**



Made in Italy

**INFRANGIBILE
SHATTERPROOF
INCASSABLE**



Drawing items - Articles de traçage

Squadra 45°
Set square 45° - Equerre 45°

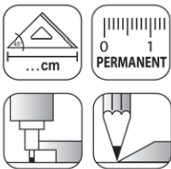

Smusso, tirachina e bordo interno
Bevelled edge, ink-edge and finger lift
Facette, bord anti-tache et bord
intérieur

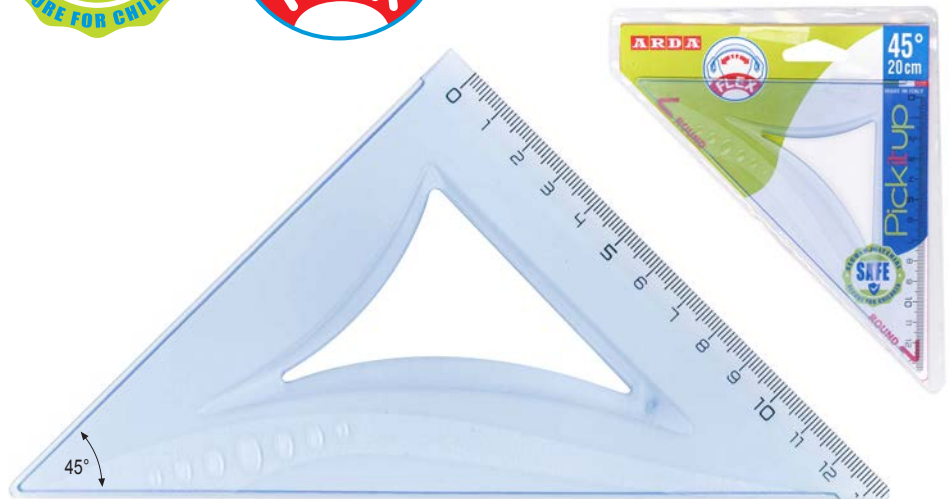

Ref. PKFL4520

Art.	EAN13 art.	Descrizione / Description	INNER pcs	EAN13 inner	MASTER pcs
PKFL4520	8003438021823	45° cm. 20	20	8003438021892	240

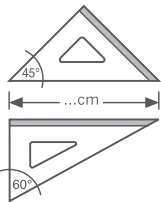

Squadra 60°
Set square 60° - Equerre 60°

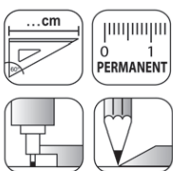

Smusso, tirachina e bordo interno
Bevelled edge, ink-edge and finger lift
Facette, bord anti-tache et bord
intérieur

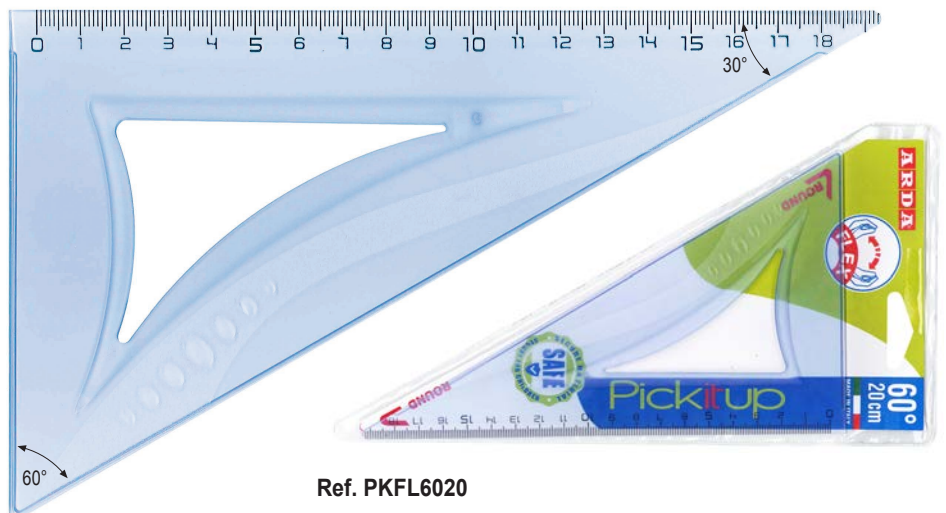

Ref. PKFL6020

Art.	EAN13 art.	Descrizione / Description	INNER pcs	EAN13 inner	MASTER pcs
PKFL6020	8003438021830	60° cm. 20	20	8003438021908	240

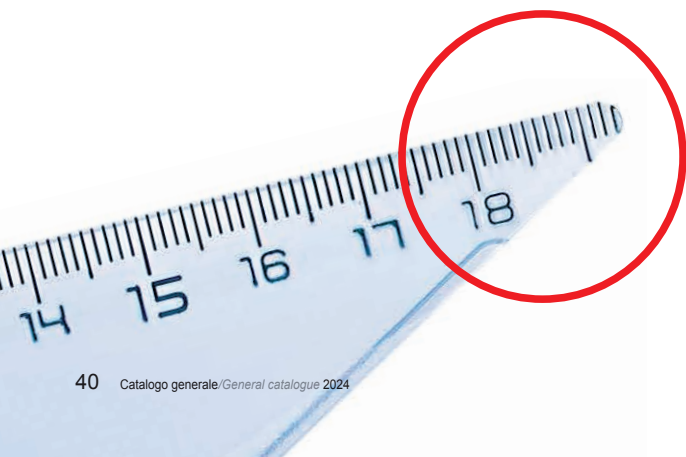

**PUNTE ARROTONDATE DI SICUREZZA
ROUND EDGES FOR SECURITY
BOUTS RONDS POUR PLUS DE SECURITÉ**



**INFRANGIBILE
SHATTERPROOF
INCASSABLE**

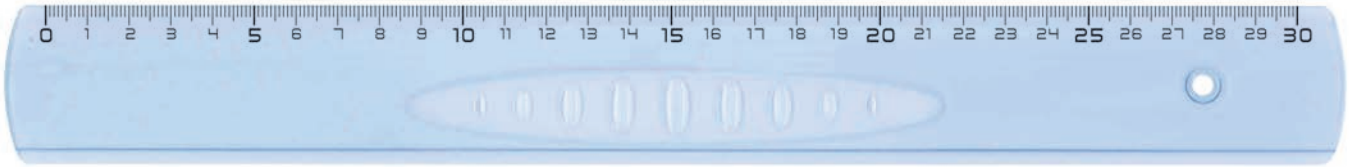

Ref. PKFL30



Riga
Ruler - Règle

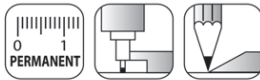

Smusso e tirachina
Bevelled edge and ink-edge
Facette et bord anti-tache

Art.	EAN13 art.	Descrizione / Description	INNER pcs	EAN13 inner	MASTER pcs
PKFL30	8003438021847	cm. 30	20	8003438021915	360

Doppio decimetro

Finger grip ruler 20cm
Double décimètre



Ref. PKFL20P

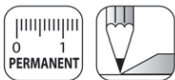

2 millimetature.
Impugnatura corta
2 graduations. Short grip
2 graduations. Poignée courte

Art.	EAN13 art.	Descrizione / Description	INNER pcs	EAN13 inner	MASTER pcs
PKFL20P	8003438021854	cm. 20	20	8003438021922	240

Goniometro 180°

Protractor 180°
Rapporteur 180°

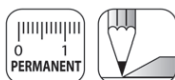

Smusso e bordo interno
Bevelled edge and finger lift
Facette et bord intérieur

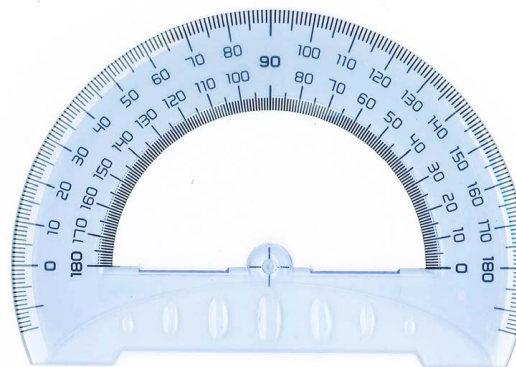

Ref. PKFL18012



Art.	EAN13 art.	Descrizione / Description	INNER pcs	EAN13 inner	MASTER pcs
PKFL18012	8003438021861	180° cm. 12	20	8003438021939	400



INFRANGIBILE
SHATTERPROOF
INCASSABLE

Set disegno 4 pz

Drawing set 4 pcs
Set de traçage 4 pcs

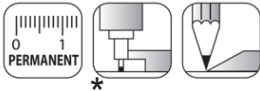

* eccetto goniometro
except protractor - sauf que rapporteur

Smusso, tirachina e bordo interno
Bevelled edge, ink-edge and finger lift
Facette, bord anti-tache et bord intérieur



Ref. PKFLSET4

Art.	EAN13 art.	Descrizione / Description	INNER pcs	EAN13 inner	MASTER pcs
PKFLSET4	8003438021885	Set 4 pz : 45° cm.20 + 60° cm.20 + R30 + 180° cm.12	50	8003438021953	50

MANCINI - LEFT

La direzione giusta
per ogni **mancino**



Made
in Italy

Per disegno tecnico e scolastico

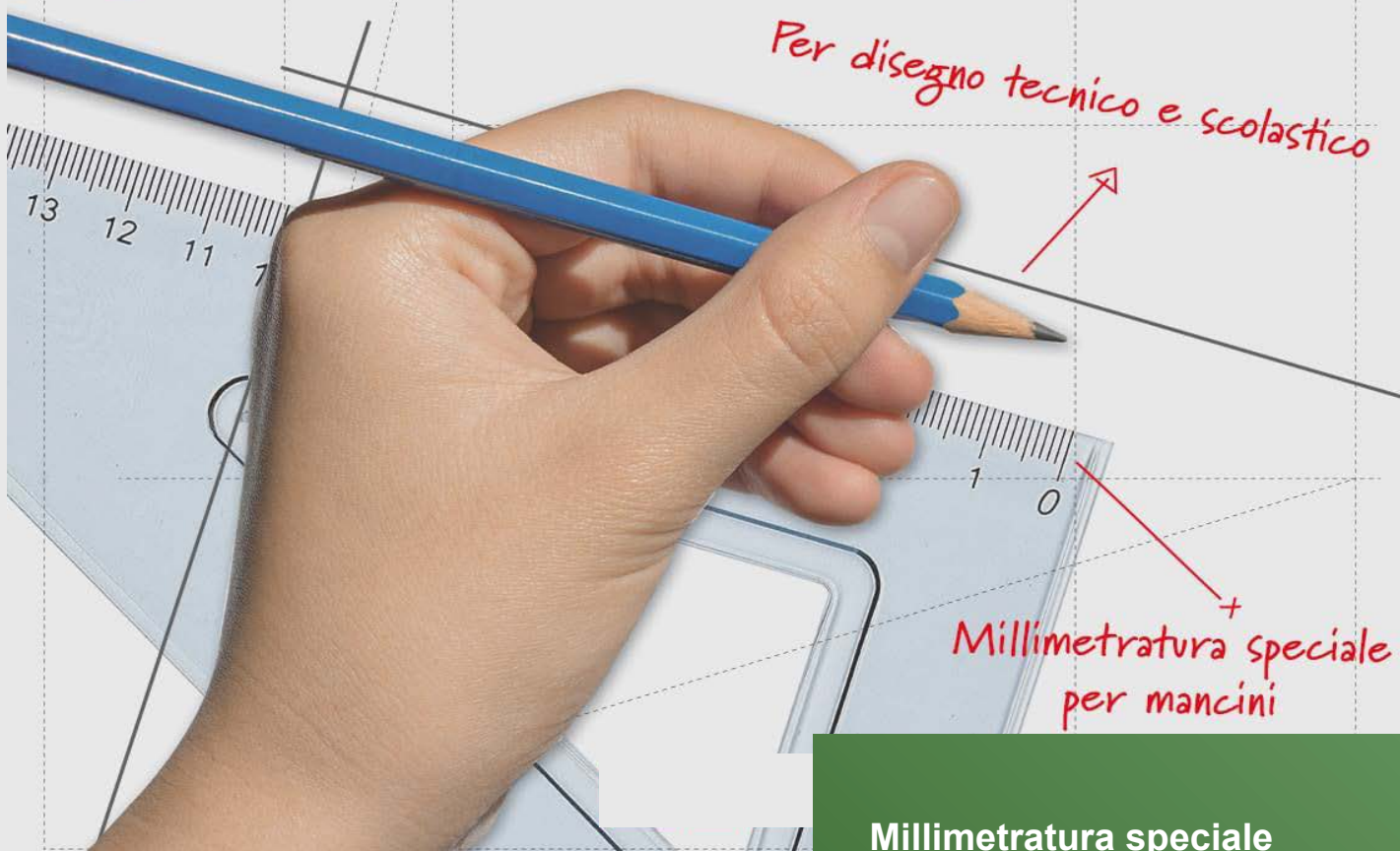

*Millimetratura speciale
per mancini*

**Millimetratura speciale
per mancini : invertita da
destra verso sinistra.**

FOR TECHNICAL AND SCHOOL USE

Special graduation for left-handers from right to left.

POUR EMPLOI TECHNIQUE ET SCOLAIRE.

Graduation spéciale pour gauchers de droit à gauche.

Made in Italy

Serie MANCINI - LEFT

Squadre

Set square - Equerre

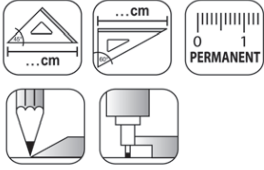

Smusso, tirachina e bordo interno
Bevelled edge, ink-edge and finger lift
Facette, bord anti-tache et bord intérieur

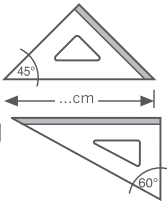

Ref. 28720MAN - 28730MAN



Ref. 28820MAN - 28830MAN

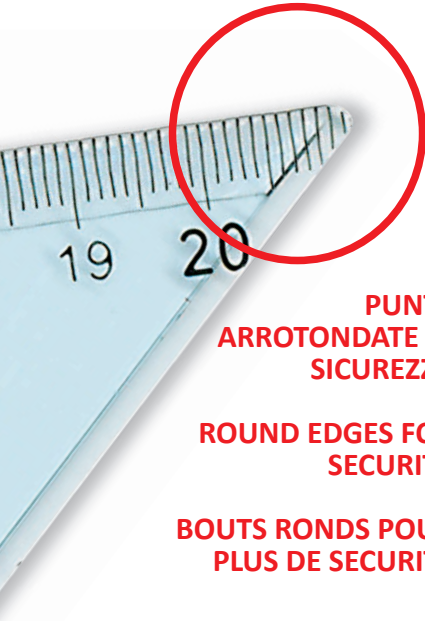
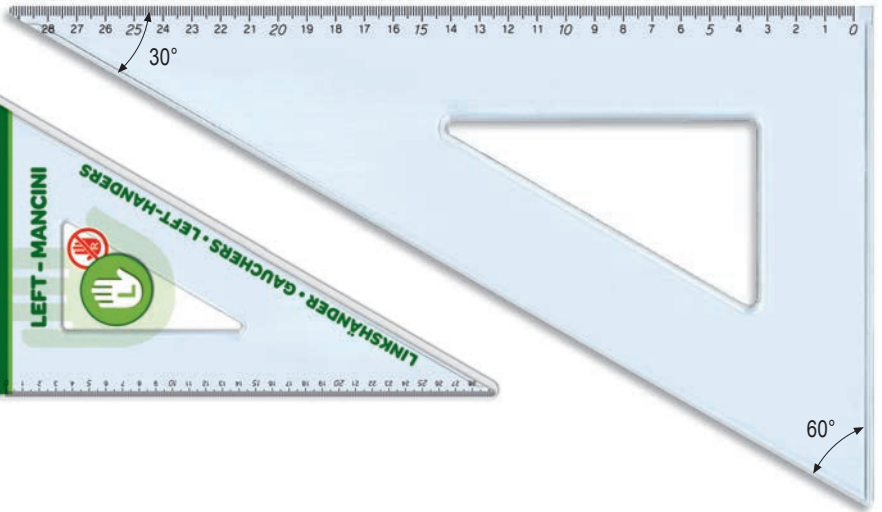

PUNTE
ARROTONDATE DI
SICUREZZA

ROUND EDGES FOR
SECURITY

BOUITS ROUNDS POUR
PLUS DE SECURITÉ

Art.	EAN13 art.	Descrizione / Description	INNER pcs	EAN13 inner	MASTER pcs
28720MAN	8003438002495	45° cm. 20	10	8003438007537	10
28820MAN	8003438002518	60° cm. 20	10	8003438007544	10
28730MAN	8003438021618	45° cm. 30	10	8003438021663	10
28830MAN	8003438021625	60° cm. 30	10	8003438021670	10

Righe

Rulers - Règles

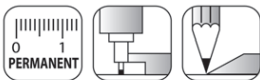

Smusso e tirachina
Bevelled edge and ink-edge
Facette et bord anti-tache



Disponibile in cm. 17 - 30 - 50



Art.	EAN13 art.	Descrizione / Description	INNER pz/pcs	EAN13 inner	MASTER pz/pcs
28917MAN	8003438021649	cm 17	10	8003438021694	10
28930MAN	8003438006899	cm 30	10	8003438007551	10
28950MAN	8003438021595	cm 50	10	8003438021656	10



Doppio decimetro

Finger grip ruler 20 cm
Double décimètre

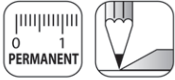

Ref. 283MAN

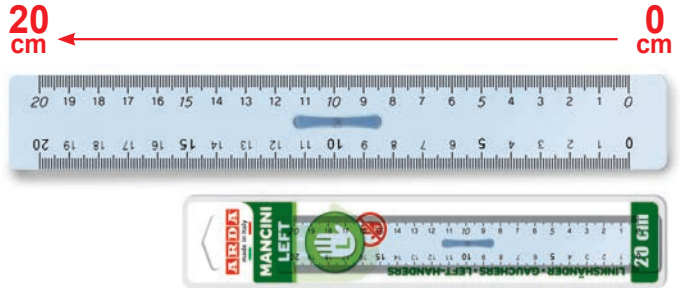

2 millimetature. Impugnatura corta.
2 graduations. Short grip.
2 graduations. Poignée corte.

Art.	EAN13 art.	Descrizione / Description	INNER pz/pcs	EAN13 inner	MASTER pz/pcs
283MAN	8003438021632	cm. 20	10	8003438021687	10

Set disegno 3 pz.

Drawing set 3 pcs - Set de traçage 3 pcs

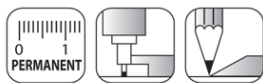

Smusso e tirachina
Bevelled edge and ink-edge
Facette et bord anti-tache

Art.	EAN13 art. 8003438...	Descrizione / Description	INNER pz/pcs	EAN13 inner 8003438...	MASTER pz/pcs
70420MAN	...002471	R30 + 45°/20 cm + 60°/20 cm	25	...007797	25
704303MAN	...022356	R30 + 45°/30 cm + 60°/30 cm	20	...022363	20

Ref. 70420MAN



Ref. 704303MAN



70
pcs
Ref. 4766MAN
32,5 x 25 x 57 h. cm

Espositore

Display - Presentoir

DISPLAY 70 pz / pcs

Art.	EAN13 art.	Descrizione / Description	INNER	MASTER
4766MAN	8003438021724	10x Sq. 45° cm.30 - ref.28730MAN 10x Sq. 60° cm.30 - ref.28830MAN 10x Righello cm.17 - ref.28917MAN 10x Righe cm.30 - ref.28930MAN 10x Righe cm.50 - ref.28950MAN 10x Set 3 pz. - ref.70420MAN 10x Doppio dec. - ref.283MAN	1	1

Disponibilità limitata alle campagne promozionali - Product availability limited to promotional campaigns - Disponibilité limitée aux campagnes promotionnelles



Contenuto per disegno tecnico su fogli A4 e A3

Content for technical drawing on A4 and A3 sheets
Contenu pour le dessin technique sur papier A4 et A3



Serie MANCINI - LEFT

ARDA

Temperamatite PER MANCINI

Sharpener for left-handers
Taille-crayons pour gauchers

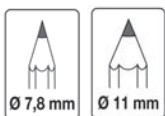

Ref. TE803MANSC
Display 8 pcs

Ean singolo per item in l'unità

Art.	EAN13 art. 8003438...	INNER pz/pcs	EAN13 inner 8003438...	MASTER pz/pcs
TE803MANSC	...030368	8	...030375	96

Forbici PER MANCINI

Scissors for left-handers
Ciseaux pour gauchers

LEFT | cm. 13

Autentiche forbici per mancini, con lame a molatura speculare. Impugnatura in ABS.

Real left-hand scissors, with specular blades :
ABS grip.

Veritables ciseaux pour gaucher, avec lames
inversées. Poignée ABS.

Lame
blade / lames :
INOX



Ref. FA1206



Ref. FA1206SF
20 pz / pcs

Ean singolo per item in l'unità

Art.	EAN13 art. 8003438...	Descrizione Description	INNER pz/pcs	EAN13 inner 8003438...	MASTER pz/pcs
FA1206	...011169	blister	10	...011565	100
FA1206SF	...032522	sfusa/bulk/vrac	20 (1 display)	...032539	200

NEW

Left & Right >> go to pg. 86

Doppia graduazione. Ideale anche per mancini.

Double graduation. Also ideal for left-handed people.

Double graduation. Idéal également pour les gauchers.



ref. 115ESP
15 pz/pcs
righello cm.15



ref. 117ESP
Display mix 45 pz/pcs



Art.	EAN13 art.	Descrizione / Description	INNER pcs	EAN13 inner	MASTER pcs
115ESP	8003438029355	Display 15 righelli/rulers/règles cm.15 (ean pcs 8003438 029324)	1	8003438029355	1
117ESP	8003438030634	Display 45 pz/pcs : 15x miniset + 15x R15cm + 15x R30 cm	1	8003438030634	1

KEEP COLOUR



**UN MONDO
DI COLORI
PASTELLO**

Made in Italy



A WORLD OF PASTEL COLORS
UN MONDE DE COULEURS PASTEL



100
pcs

Ref. KCP4766
32,5 x 25 x 57 h. cm

Espositore
Display - Presentoir

DISPLAY 100 pz / pcs

Art.	EAN13 art.	Descrizione / Description	INNER	MASTER
KCP4766	8003438022561	20x Sq. 45° cm. 30 20x Sq. 60° cm. 30 20x Righe cm. 50 10x Doppio dec. cm. 20 10x Triplo dec. cm. 30 20x Gon. 360° cm. 12	1	1

Disponibilità limitata alle campagne promozionali - Product availability limited to promotional campaigns - Disponibilité limitée aux campagnes promotionnelles



Contenuto specifico per disegno tecnico su fogli A3

Specific content for technical drawing on A3 sheets

Contenu spécifique pour le dessin technique sur papier A3

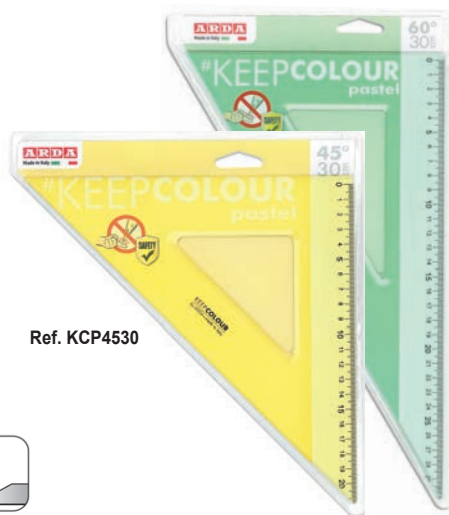

Ref. KCP4530

Ref. KCP6030



Ref. KCP18012



Ref. KCP36012



Ref. KCGEO300



Ref. KCP20P

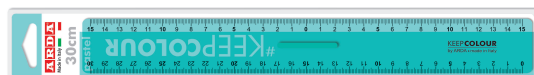

Ref. KCP30P



Ref. KCP50

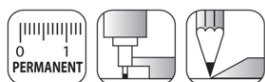
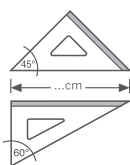

Smusso, tirachina e bordo interno
Bevelled edge, ink-edge and finger lift
Facette, bord anti-tache et bord intérieur

Art.	EAN13 art.	Descrizione / Description	INNER pz/pcs	EAN13 inner	MASTER pz/pcs
KCP4530	8003438 022578	Squadra / set square / Equerre 45° cm. 30	10	8003438 022646	10
KCP6030	8003438 022585	Squadra / set square / Equerre 60° cm. 30	10	8003438 022653	10
KCP50	8003438 022592	Riga / ruler / règle cm. 50	10	8003438 022660	10
KCP20P	8003438 022608	Doppio decimetro / Finger grip ruler cm.20 / Double décimètre	10	8003438 022677	10
KCP30P	8003438 022615	Triplo decimetro / Finger grip ruler cm.30 / Triple décimètre	10	8003438 022684	10
KCP18012	8003438 028761	Goniometro / Protractor / Rapporteur 180° 12cm	10	8003438 028778	10
KCP36012	8003438 022622	Goniometro / Protractor / Rapporteur 360° 12cm	10	8003438 022691	10
KCGEO300	8003438 018724	GEO300 cm.16	10	8003438 018762	350

Miniset disegno 3 pezzi

Drawing minikit 3 pcs
Miniset de tracage 3 pcs

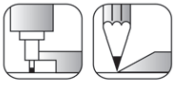

Smusso e tirachina
Bevelled edge and ink-edge
Facette et bord anti-tache



Ref. KCP7063DSS

Miniset:
- 45° cm.15
- 60° cm.15
- R16

Art.	EAN13 art.	Descrizione / Description	INNER pz/pcs	EAN13 inner	MASTER pz/pcs
KCP7063DSS	8003438 022530	Miniset 3 pcs : 45° cm.15 + 60° cm.15 + R16	20	8003438 022028	20



Espositore 48 righelli 16 cm

Display 48 pcs. Ruler 16 cm.
Presentoir 48 pcs. Règle 16 cm.

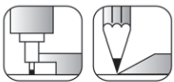

Smusso e tirachina
Bevelled edge and ink-edge
Facette et bord anti-tache

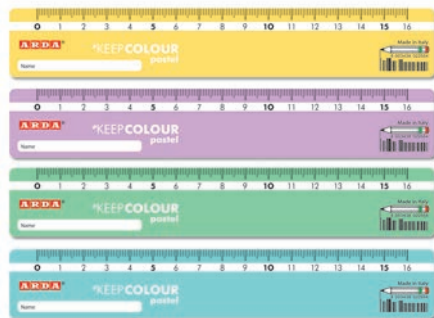

48
pcs

Ref. KCP17DESP
24,6 x 6,7 x 19 h. cm



Art.	EAN13 art.	Descrizione / Description	INNER pz/pcs	EAN13 inner	MASTER pz/pcs
KCP17DESP	8003438 022547	Display 48 pz - R16 cm (Ean pz 8003438 022554)	1	8003438 022547	1

Tutto a POSTO e... tutto in ordine !

Miniset disegno in busta con zip

Drawing miniset in bag with zip

Miniset de traçage in pochette avec zip



PORTA
CON TE IL
MINISET NEL
RACCOLTITORE
AD ANELLI

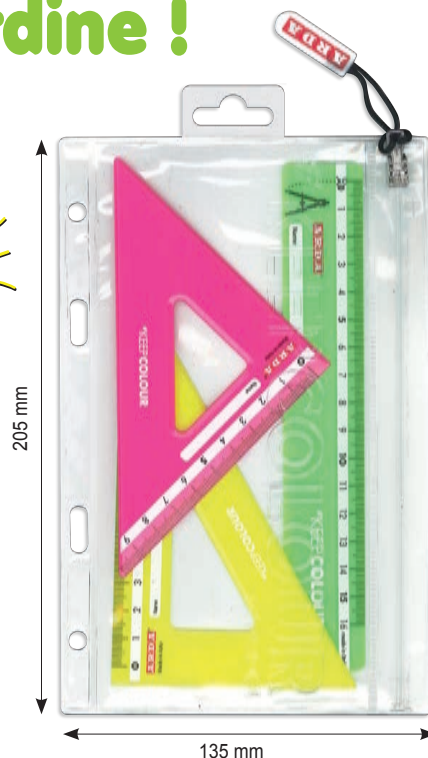

Ref. KC7063

Foratura universale - Multi punches / Perforation universelle

Art.	EAN13 art.	Descrizione / Description	INNER pcs	EAN13 inner	MASTER pcs
KC7063	8003438028181	Miniset 3 pz/pcs : 45°cm.15 + 60°cm.15 + R16	10	8003438028228	10

Set disegno in busta porta album

Drawing set in album holder envelope

Set de traçage dans une enveloppe porte papier à dessin

Ref. KC60430

SUL RETRO
PUOI INSERIRE
ANCHE IL
TUO ALBUM
DISEGNO!



Custodia con gli articoli indispensabili per il disegno tecnico. Per ogni pezzo è prevista la sua sede e sul retro è prevista una tasca nella quale riporre l'album da disegno. Busta disponibile in 3 colori assortiti.

Smart case with essential items for technical drawing. For each piece there is its own place and on the back there is a pocket in which to store the sketchbook. Case in 3 fluo assorted colours.

Pochette avec les essentiels pour le dessin technique. Pour chaque pièce, il y a son propre siège et à l'arrière il y a une poche dans laquelle ranger le papier à dessin. Pochette en 3 couleurs assorties.

album non incluso - album not included - papier à dessin non inclus

Art.	EAN13 art.	Descrizione / Description	INNER pcs	EAN13 inner	MASTER pcs
KC60430	8003438028198	Set disegno 4 pz/pcs in busta porta album : 45°cm.30 + 60°cm.30 + R30 + 360° cm.12	10	8003438028235	10

Isoteck

ARDA

DISEGNO

PER IL DISEGNO TECNICO PROFESSIONALE



Drawing Tools - Articles de traçage

FOR PROFESSIONAL TECHNICAL DRAWING

Specific line for technical drawing. Is injected in PLEXIGLAS® material, strong and extra transparent. The graduation is etched and indelible.

POUR LE DESSIN TECHNIQUE PROFESSIONNEL

Gamme de traçage pour le dessin technique. La matière employé est le PLEXIGLAS®, très résistante et de haute transparence. La gravure de la graduation est indélébile.

É la serie di precisione per il disegno tecnico professionale.

Il materiale impiegato è il PLEXIGLAS®, resistente agli urti e ai graffi e di massima trasparenza. La graduazione è incisa ed indelebile.

**PROFESSIONAL
HIGH QUALITY**

Made in Italy

MATERIALE ACRILICO
® plexiglas

PROFESSIONAL - HIGH QUALITY [®] plexiglas

Squadre

Set square - Equerre

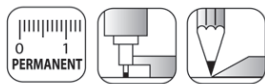

Smusso, tirachina e bordo interno
Bevelled edge, ink-edge and finger lift
Facette, bord anti-tache et bord intérieur

Ref. 73012 - 16 - 26 -
32 - 37 - 42 - 50

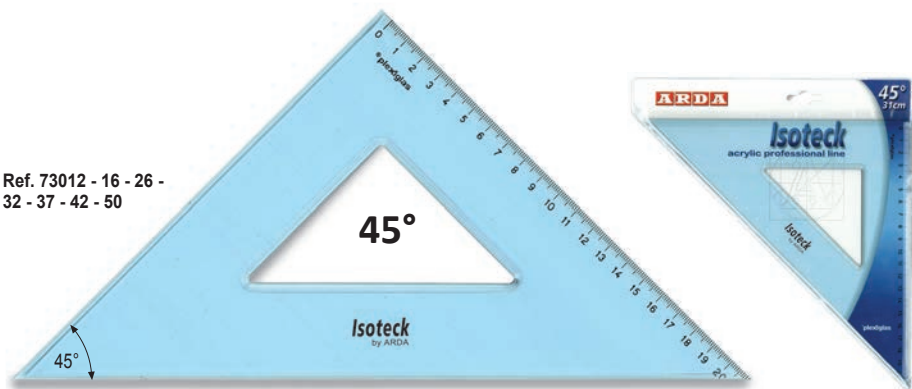

Art.	EAN13 art.	Descrizione / Description	INNER pcs	EAN13 inner	MASTER pcs
73012	8003438730121	45° cm. 12	10	8003438732125	10
73016	8003438730169	45° cm. 16	10	8003438732163	10
73026	8003438730268	45° cm. 26	10	8003438732262	10
73032	8003438730329	45° cm. 31	10	8003438732323	10
73037	8003438730374	45° cm. 36	10	8003438732378	10
* 73042	8003438730428	45° cm. 42	1	8003438730428	10
* 73050	8003438730503	45° cm. 50	1	8003438730503	10

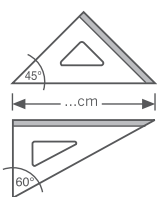

* Ricavate da lastra - Cut from plate
Découpé à partir de la plaque

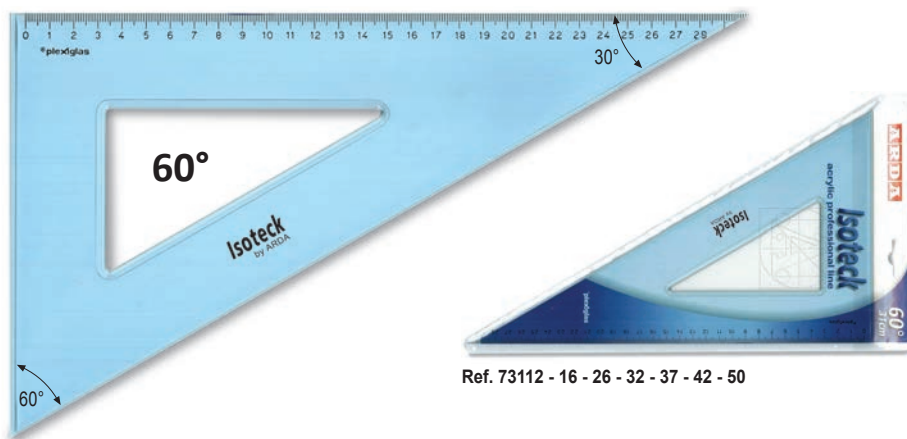

Ref. 73112 - 16 - 26 - 32 - 37 - 42 - 50

Art.	EAN13 art.	Descrizione / Description	INNER pcs	EAN13 inner	MASTER pcs
73112	8003438731128	60° cm. 12	10	8003438733122	10
73116	8003438731166	60° cm. 16	10	8003438733160	10
73126	8003438731265	60° cm. 26	10	8003438733269	10
73132	8003438731326	60° cm. 31	10	8003438733320	10
73137	8003438731371	60° cm. 36	10	8003438733375	10
* 73142	8003438731425	60° cm. 42	1	8003438731425	10
* 73150	8003438731500	60° cm. 50	1	8003438731500	10

Righe

Rulers - Règles

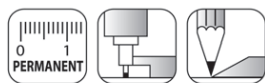

Smusso e tirachina
Bevelled edge and ink-edge
Facette et bord anti-tache



Ref. 70030 - 50 - 60 - 80 - 120 - 150



Art.	EAN13 art.	Descrizione / Description	INNER pcs	EAN13 inner	MASTER pcs
70030	8003438700308	cm. 30	10	8003438710307	10
70050	8003438700506	cm. 50	10	8003438710505	10
70060	8003438700605	cm. 60	10	8003438710604	10
70080	8003438700803	cm. 80	10	8003438710802	10
* 700120	8003438700124	cm. 120	1	8003438700124	5
* 700150	8003438700155	cm. 150	1	8003438700155	5

* Ricavate da lastra - Cut from plate
Découpé à partir de la plaque

PROFESSIONAL - HIGH QUALITY [®] **plexiglas**

Righe per parallelografi

Parallel rulers
Règles pour parallèles

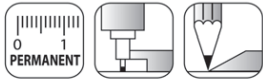

Ref. 70150 - 60 - 70 - 80 -100 -120

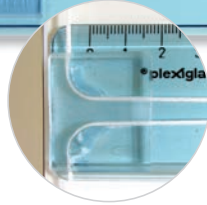

Guscette in plexiglas per scorrimento a filo
Plexiglas slide-guides for thread
Glissières en plexiglas pour fil

Filo non incluso - Wire not included - Fil non inclus

Smusso e tirachina
Bevelled edge and ink-edge
Facette et bord anti-tache

* Ricavate da lastra - Cut from plate
Découpé à partir de la plaque

Art.	EAN13 art.	Descrizione / Description	INNER pcs	EAN13 inner	MASTER pcs
70150	8003438701503	cm. 50	1	8003438701503	10
70160	8003438701602	cm. 60	1	8003438701602	10
70170	8003438701701	cm. 70	1	8003438701701	10
70180	8003438701800	cm. 80	1	8003438701800	10
* 701120	8003438701121	cm. 120	1	8003438701121	10

Drawing items - Articles de tracage

Doppio e Triplo decimetro

Finger grip ruler 20-30cm
Double e triple décimètre

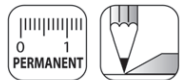

2 millimetrature. Impugnatura lunga.
2 graduations. Long grip.
2 graduations. Longue poignée.



Ref. 68020

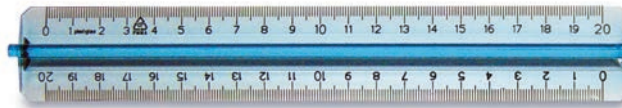

Ref. 68030

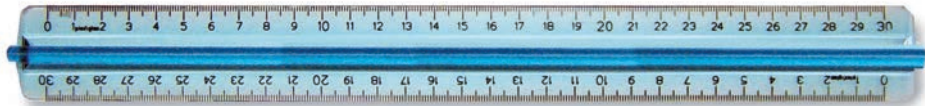

Art.	EAN13 art.	Descrizione / Description	INNER pcs	EAN13 inner	MASTER pcs
68020	8003438680204	cm. 20	10	8003438681201	10
68030	8003438680303	cm. 30	10	8003438681300	10

Goniometri

Protractor - Rapporteur

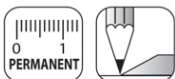

Smusso e bordo interno
Bevelled edge and finger lift
Facette et bord intérieur

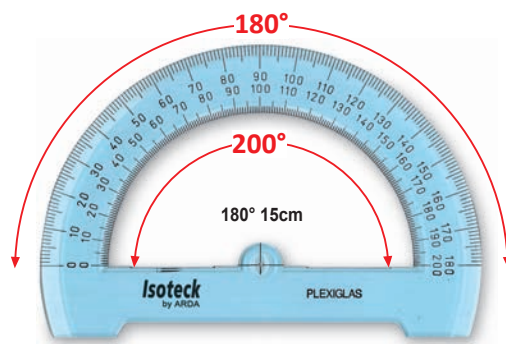

Ref. 750

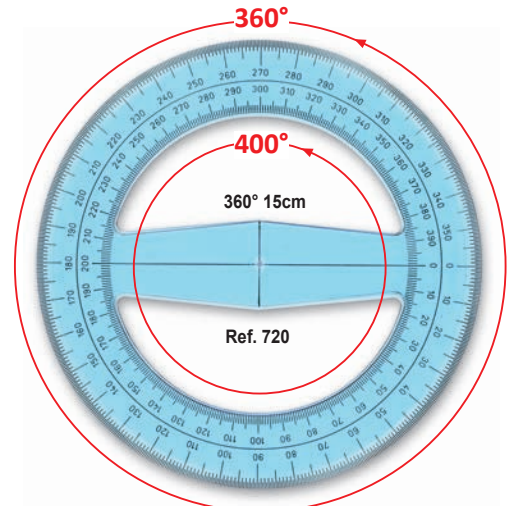

Ref. 720



Art.	EAN13 art.	Descrizione / Description	INNER pcs	EAN13 inner	MASTER pcs
750	8003438007506	180° cm. 15	10	8003438107503	10
720	8003438007209	360° cm. 15	10	8003438107206	10

Serie ISOTECK

ARDA

PROFESSIONAL - HIGH QUALITY

plexiglas

Ref. 641
Display
cm. 32,5 x 25 x 65 h.

Espositore
Display
Presentoir

47
pcs

Art.	EAN13 art.	Descrizione / Description	INNER	MASTER
641	8003438013620	5x Sq. 45° cm. 31 - ref. 73032 5x Sq. 60° cm. 31 - ref. 73132 5x Sq. 45° cm. 36 - ref. 73037 5x Sq. 60° cm. 36 - ref. 73137 5x Righe cm. 50 - ref. 70050 5x Righe cm. 60 - ref. 70060 10x Triplo dec. cm. 30 - ref. 68030 5x Gon. 180° cm. 15 - ref. 750 1x bar. 15 pz. R15 cm alu - ref.17915BAR 1x bar. 12 portamine 2 mm ref. 4017	1	1

Disponibilità limitata alle campagne promozionali - Product availability limited to promotional campaigns - Disponibilité limitée aux campagnes promotionnelles



Contenuto specifico per disegno tecnico su fogli A3

Specific content for technical drawing on A3 sheets

Contenu spécifique pour le dessin technique sur papier A3

Righe T

T-squares - Règle à "T"

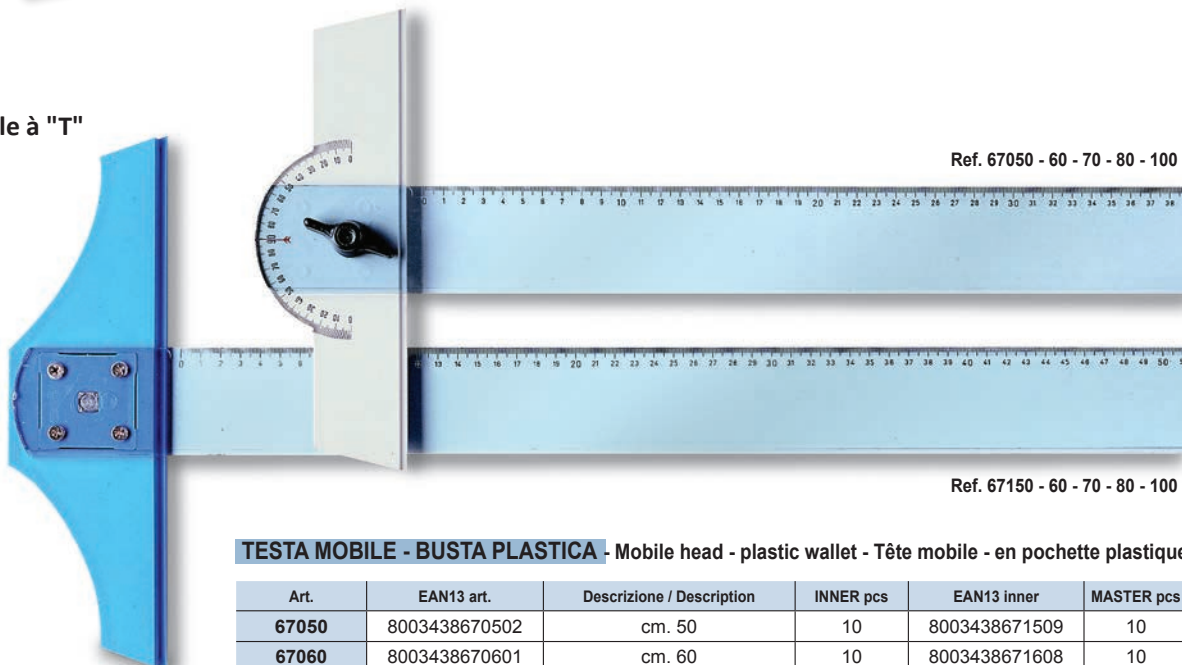

Ref. 67050 - 60 - 70 - 80 - 100

Ref. 67150 - 60 - 70 - 80 - 100

TESTA MOBILE - BUSTA PLASTICA - Mobile head - plastic wallet - Tête mobile - en pochette plastique

Art.	EAN13 art.	Descrizione / Description	INNER pcs	EAN13 inner	MASTER pcs
67050	8003438670502	cm. 50	10	8003438671509	10
67060	8003438670601	cm. 60	10	8003438671608	10
67070	8003438670700	cm. 70	10	8003438671707	10
67080	8003438670809	cm. 80	10	8003438671806	10
* 67100	8003438670106	cm. 100	1	8003438670106	1

TESTA FISSA - BUSTA CELLOPHANE - Fixed head - cellophane wallet - Tête fixe en pochette cellophane

Art.	EAN13 art.	Descrizione / Description	INNER pcs	EAN13 inner	MASTER pcs
67150	8003438671516	cm. 50	10	8003438067159	10
67160	8003438671615	cm. 60	10	8003438067166	10
67170	8003438671714	cm. 70	10	8003438067173	10
67180	8003438671813	cm. 80	10	8003438067180	10
* 671100	8003438711007	cm. 100	1	8003438711007	1

* Ricavate da lastra. Righe colore cristallo.
Cut from plate. Crystal color ruler.
Découpé à partir de la plaque. Règle de couleur cristal.

Righe speciali 35 cm

Specific rulers 35 cm
Règles spéciales 35 cm

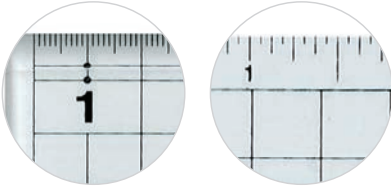

Ref. 97035

Art.	EAN13 art.	Descrizione / Description	INNER pcs	EAN13 inner	MASTER pcs
97035	8003438970350	cm. 5 x 35	10	8003438971357	10

Righe per tabulati

Ruler for records reading
Règle pour la lecture des textes



Ref. 389

Art.	EAN13 art.	Descrizione / Description	INNER pcs	EAN13 inner	MASTER pcs
389	8003438389008	cm. 40	20	8003438389107	20

Curvilinee deformabili millimetrata

Flexible curves with graduation
Courbe flexibles avec graduation



Tirachina
Ink-edge
Anti-tache

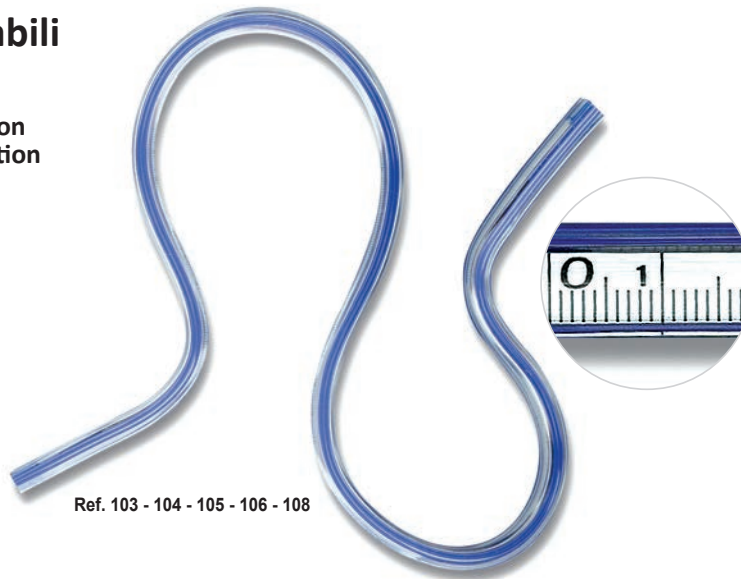

Ref. 103 - 104 - 105 - 106 - 108



Art.	EAN13 art.	Descrizione / Description	INNER pcs	EAN13 inner	MASTER pcs
103	8003438001030	cm. 30	10	8003438101037	10
104	8003438001047	cm. 40	10	8003438101044	10
105	8003438001054	cm. 50	10	8003438101051	10
106	8003438001061	cm. 60	10	8003438101068	10
108	8003438001085	cm. 90	10	8003438101082	10

Scalimetri in plastica

Triangular scale in plastic
Echelle rd réduction en plastique



Ref. 109 **A** Uso edilizia - For building purposes - Pour construction
1:100 - 200 - 250 - 300 - 400 - 500



Ref. 110 **B** Uso arredamento - For furnishing purposes - Pour ameublement
1:20 - 25 - 50 - 75 - 100 - 125



Ref. 111 **C** Uso catasto - For land registry purposes - Pour Cadastral
1:500 - 1000 - 1250 - 1500 - 2000 - 2500



Sezione triangolare con canaline colorate
Triangular section with coloured grooves
Section triangulaire avec rainures en
couleurs divers

	Art.	EAN13 art.	Descrizione / Description	INNER pcs	EAN13 inner	MASTER pcs
A	109	8003438001092	EDILIZIA cm.30	1	8003438001092	12
B	110	8003438001108	ARREDAMENTO cm.30	1	8003438001108	12
C	111	8003438001115	CATASTO cm. 30	1	8003438001115	12





Drawing items - Articles de trépage

STRUMENTI PER IL CARTEGGIO NAUTICO.

EQUIPMENT FOR NAUTICAL CARTOGRAPHY
INSTRUMENTS POUR LES MAPPES DE NAVIGATION.

Made in Italy



Set per carteggio nautico
Nautical set - Set pour nautique

NEW

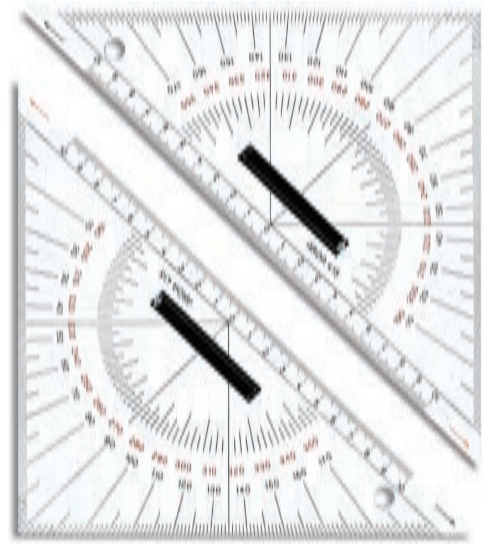

ref. 424

Pregiata e resistente busta con chiusura magnetica

High-quality and resistant envelope with magnetic closure

Enveloppe de haute qualité et résistante avec fermeture magnétique



NAUTIC

Art.	EAN13 art.	Descrizione / Description	INNER pcs	EAN13 inner	MASTER pcs
424	8003438016041	Set 4 pz : 2x squadre nautiche cm.26 ref. 415 1x compasso nautico in zama in custodia sing. ref.420 1x portamine 0,5 ref.903	1	8003438016041	3

Compasso nautico

Nautical compass - Compas nautique

Compasso in zama

Zama compass - Compas de zama

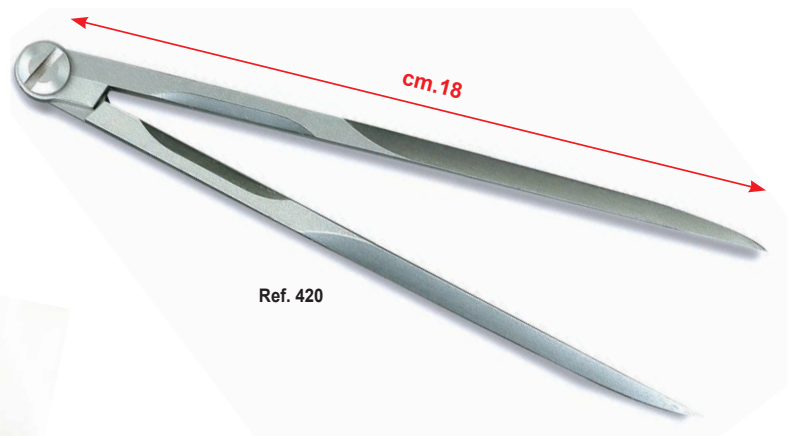

Ref. 420



Art.	EAN13 art.	Descrizione / Description	INNER pcs	EAN13 inner	MASTER pcs
420	8003438420008	Compasso nautico	1	8003438420008	10

Squadre nautiche

45° 26 cm

Set square 45° 26 cm
Equerres 45° 26 cm

plexiglas

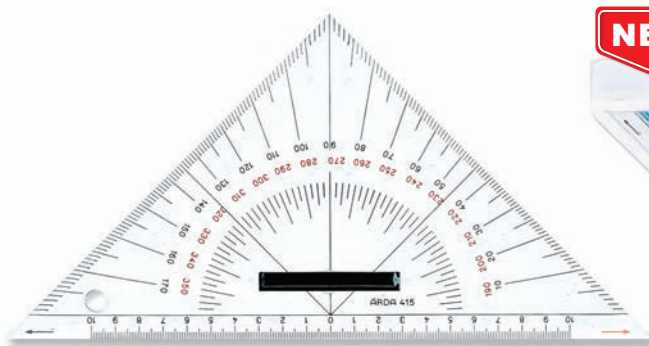

NEW PACKAGING
ref. 415 - 416 - 417

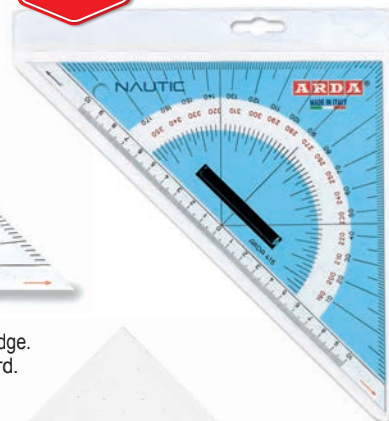

Ref. 415 Con pomolo e millimetratura con linea di fede.
With grip, graduated with hypotenuse scale detached from edge.
Avec poignée et graduation hypotenuse détachée du bord.

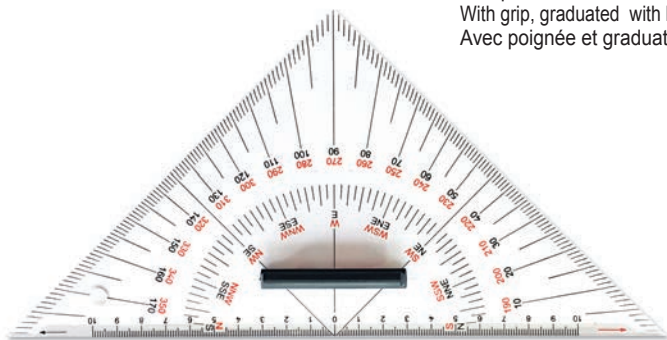

Ref. 416 Con pomolo, millimetrata con linea di fede sul bordo.
With grip, graduated with hypotenuse scale on the edge.
Avec poignée et graduation hypotenuse sur le bord.

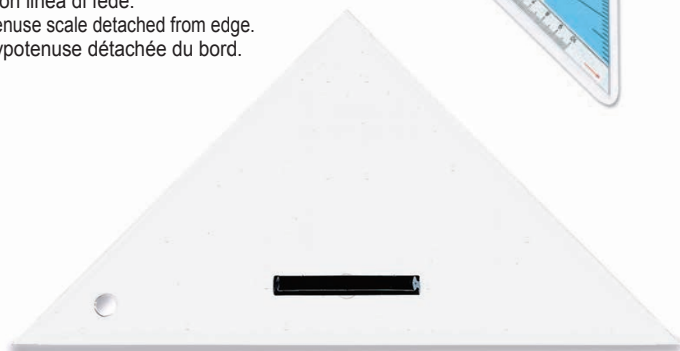

Ref. 417 Neutra con pomolo - Without graduation, with handle - Non-graduée, avec poignée

Art.	EAN13 art.	Descrizione / Description	INNER pcs	EAN13 inner	MASTER pcs
415	8003438415004	45° cm.26	10	8003438415011	10
416	8003438416001	45° cm.26	10	8003438416018	10
417	8003438417008	45° cm.26	10	8003438417015	10

Squadre nautiche

45° 32 cm

Set square 45° 32 cm
Equerres 45° 32 cm

plexiglas

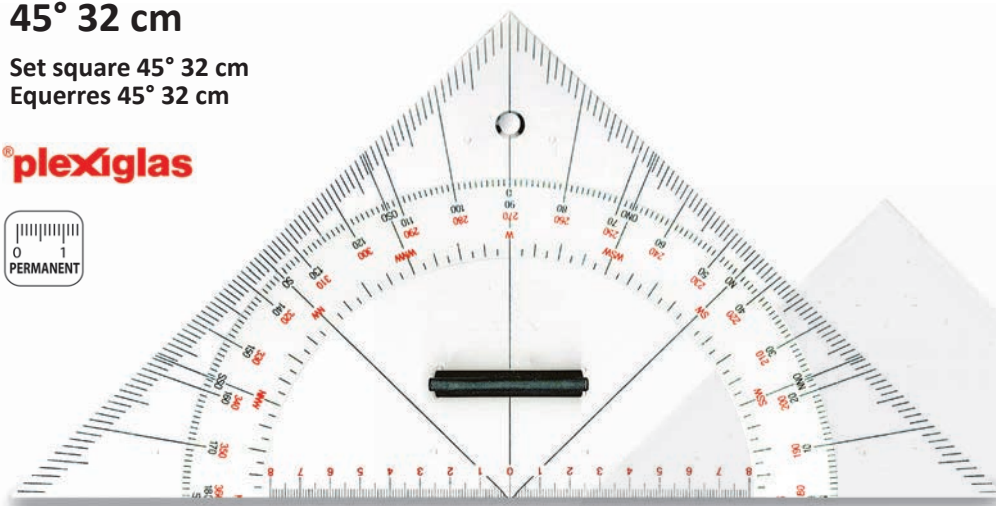

Ref. 418
Con pomolo, millimetrata con linea di fede sul bordo.
With grip, graduated with hypotenuse scale on the edge.
Avec poignée et graduation hypotenuse sur le bord.

Ref. 419
Neutra con pomolo
Without graduation, with handle.
Non-graduée, avec poignée



Art.	EAN13 art.	Descrizione / Description	INNER pcs	EAN13 inner	MASTER pcs
418	8003438418005	45° cm.32	10	8003438418012	10
419	8003438419002	45° cm.32	10	8003438419019	10

Goniometri

Protractor - Rapporteur

plexiglas

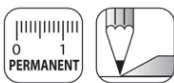

Smusso e bordo interno
Bevelled edge and finger lift
Facette et bord intérieur

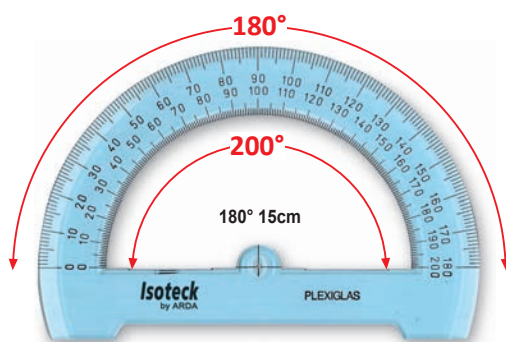

Ref. 750

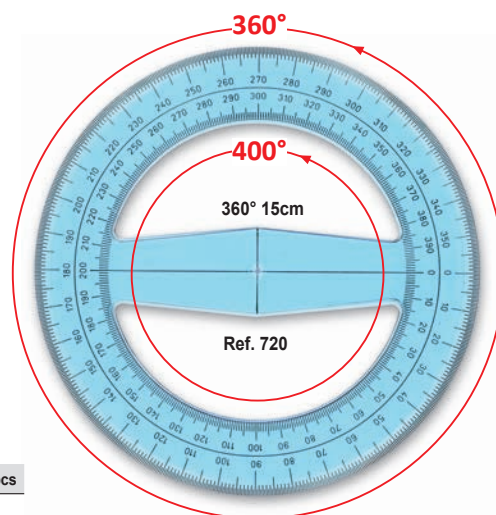

Ref. 720

Art.	EAN13 art.	Descrizione / Description	INNER pcs	EAN13 inner	MASTER pcs
750	8003438007506	180° cm. 15	10	8003438107503	10
720	8003438007209	360° cm. 15	10	8003438107206	10

Righe a rullo

Rolling ruler - Règle roulante

plexiglas

Rulli in ottone con gomma antiscivolo
Brass roller with no-sliding rubber
Rouleau en laiton avec gomme antidérapant

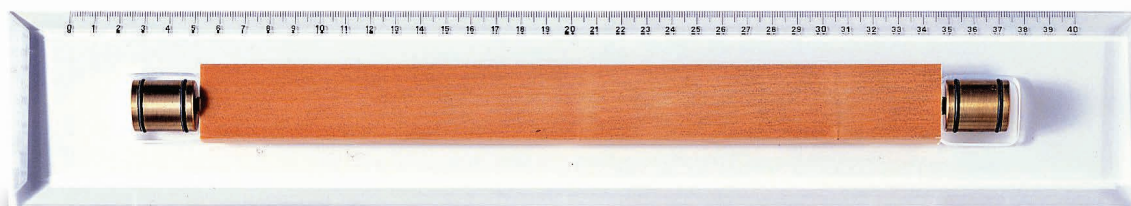

Ref. 328

Art.	EAN13 art.	Descrizione / Description	INNER pcs	EAN13 inner	MASTER pcs
328	8003438328014	cm. 40	1	8003438328014	1

Righe parallele

Parallel rulers
Règles parallèles

Ref. 325SC

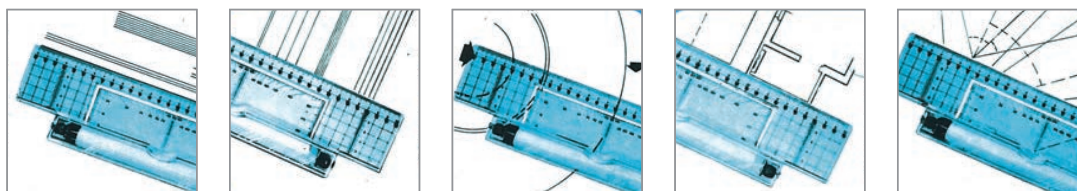
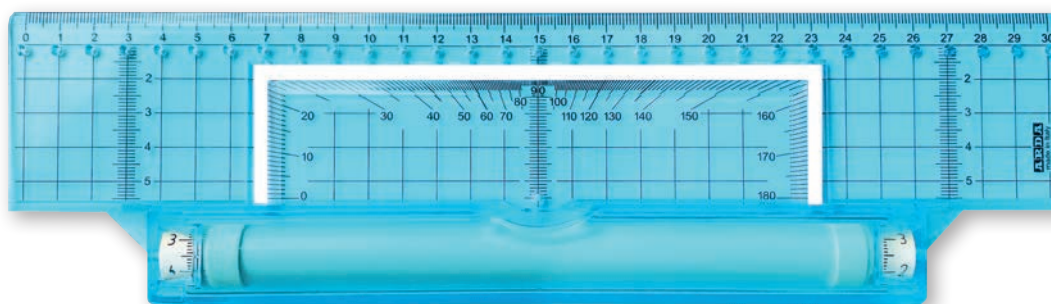

Art.	EAN13 art.	Descrizione / Description	INNER pcs	EAN13 inner	MASTER pcs
325SC	8003438325006	cm.30	1	8003438325006	5

Made in Italy

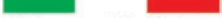

Righe
Rulers - Règles

Ref. 52030 - 40



Ref. 52080



Ref. 520100



Profilo di plastica integrato per resistere ai lavori di taglio
Integrated plastic profile to resist cutting jobs
Profil en plastique intégré pour résister aux travaux de coupe

Bordo tirachina - graduazione fotoincisa
bordi rettificati
Ink-edge - Photo-engraved graduation -
Bevelled edge
Bord anti-tache - Graduation photo-
gravée - Facette

Art.	EAN13 art.	Descrizione / Description	INNER pcs	EAN13 inner	MASTER pcs
52030	8003438520302	cm. 30	1	8003438520302	10
52040	8003438520401	cm.40	1	8003438520401	10
52080	8003438520807	cm. 80	1	8003438520807	10
520100	8003438520104	cm. 100	1	8003438520104	10

Tavoletta per disegno
(parallelografi)

Drawing boards (parallelograph)
Tables à dessin (parallélographe)

Scorrimento a filo.
Sliding with thread.
Glissement à fil.

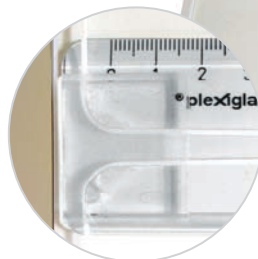

Con leggio
with stand - avec lutrin

Art.	EAN13 art.	F.to / size	INNER	EAN13 inner	MASTER
050M	8003438014153	cm.40x53	1	8003438014153	8
060M	8003438014207	cm.48x63	1	8003438014207	7
070M	8003438014214	cm.50x73	1	8003438014214	5

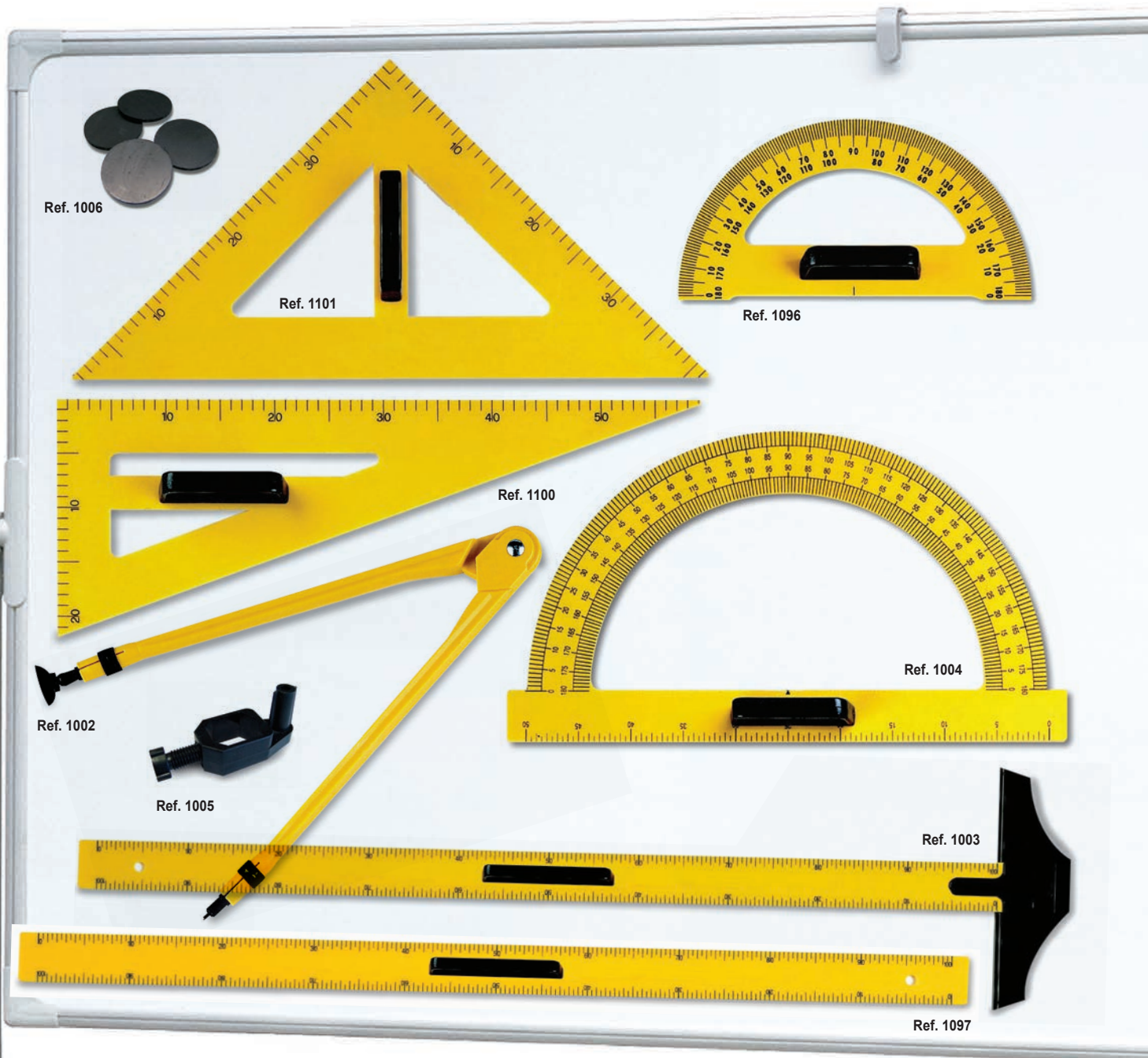

in plastica - in plastic - en plastique

Art.	EAN13 art.	Descrizione / Description	INNER pcs	EAN13 Inner	MASTER pcs
1100	8003438011008	Squadra / set square / equerre 70° cm. 60	1	8003438011008	50
1101	8003438011015	Squadra / set square / equerre 45° cm. 60	1	8003438011015	50
1096	8003438010964	Goniometro / protractor / rapporteur 180° cm.35	1	8003438010964	50
1004	8003438010049	Goniometro / protractor / rapporteur 180° cm.50	1	8003438010049	50
1097	8003438010971	Riga / ruler / règle cm. 100	1	8003438010971	25
1003	8003438010032	Riga T / T ruler / règle "T" cm.100	5	8003438031730	5
1002	8003438010025	Compasso / compass / compas cm. 35	1	8003438010025	5
1005	8003438010056	Adattatore per compasso compass adaptor / adaptateur pour compas	1	8003438010056	50
1006	8003438010063	Set 4 calamite / set 4 magnets / set 4 aimants	20	8003438110060	20

ALLUMINIO ANODIZZATO CLASSICO E COLORATO

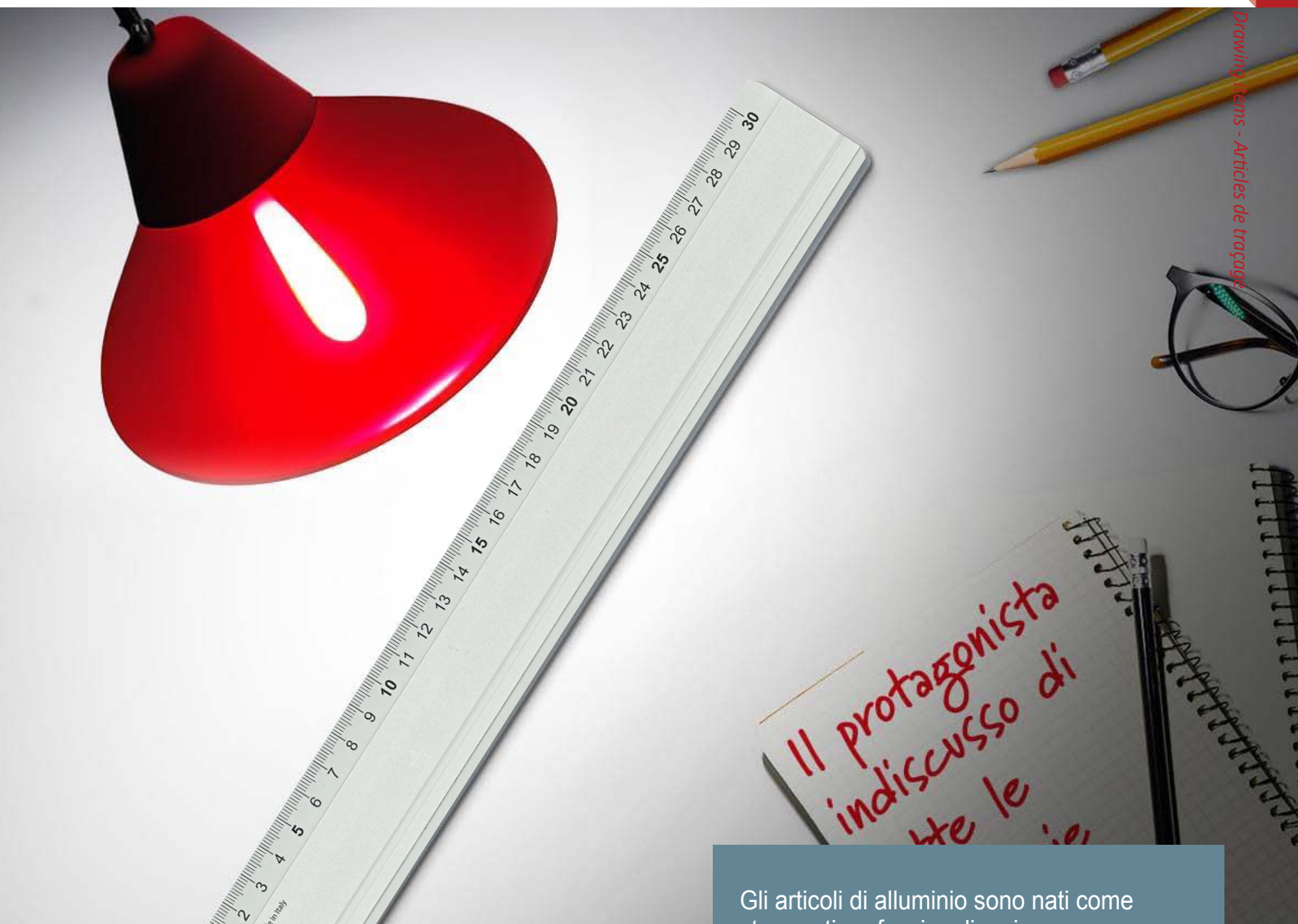

Gli articoli di alluminio sono nati come strumenti professionali e si sono poi largamente diffusi come prodotti scolastici grazie alla robustezza e solidità dell'alluminio.

ANODIZED ALUMINUM CLASSIC AND COLORFUL

The articles of aluminium were conceived as professional tools and have been widely used as educational products thanks to the strength and stability of aluminium.

ALUMINIUM ANODISÉ CLASSIQUE ET COLORÉ

Les articles en aluminium sont nés comme un outil professionnel et ont été largement utilisés comme produits éducatifs grâce à la robustesse et la solidité de l'aluminium.

Made in Italy

Aluminium PROFIL

Squadre 45°

Set square 45° - Equerre 45°

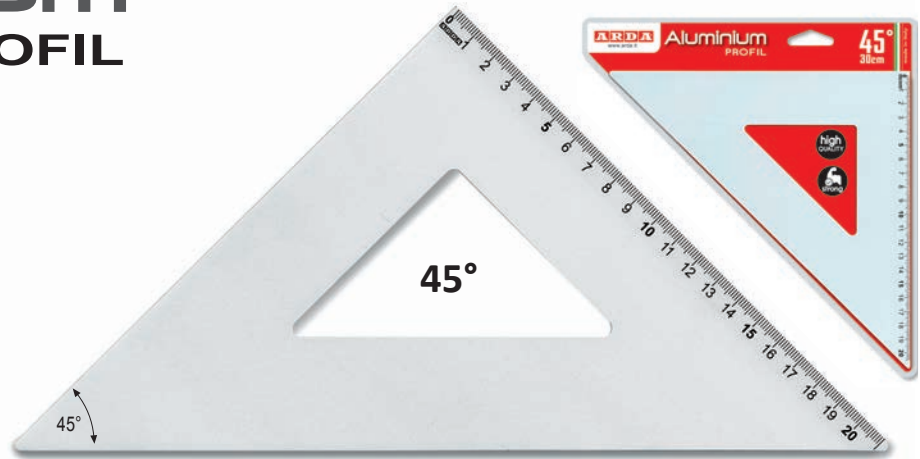

Ref. 18026 - 32 - 40

Art.	EAN13 art.	Descrizione / Description	INNER pcs	EAN13 inner	MASTER pcs
18026	8003438180261	45° cm.25	3	8003438188267	30
18032	8003438180322	45° cm. 30	3	8003438188328	30
18040	8003438180407	45° cm. 35	3	8003438188403	3

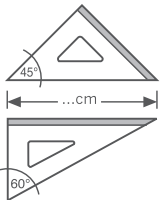

Squadre 60°

Set square 60° - Equerre 60°

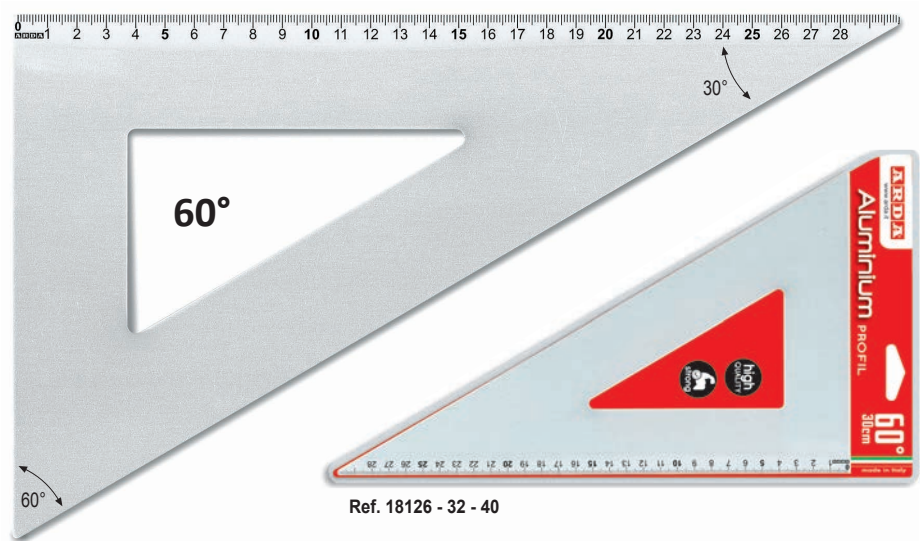
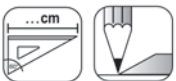

Ref. 18126 - 32 - 40

Art.	EAN13 art.	Descrizione / Description	INNER pcs	EAN13 inner	MASTER pcs
18126	8003438181268	60° cm. 25	3	8003438189264	30
18132	8003438181329	60° cm. 30	3	8003438189325	30
18140	8003438181404	60° cm. 35	3	8003438189400	3

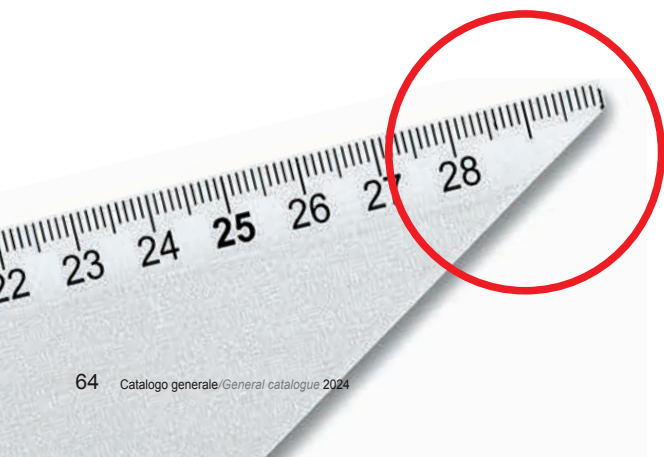

**PUNTE ARROTONDATE DI SICUREZZA
ROUND EDGES FOR SECURITY
BOUTS ROUNDS POUR PLUS DE SECURITÉ**

Righe

Rulers - Règles

Ref. 18230 - 40 - 50 - 60 - 70 - 80 - 100

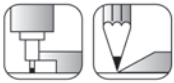

Gomma antiscivolo e tirachina
With no-sliding rubber and ink-edge
Avec patin antidérapant et bord anti-tache

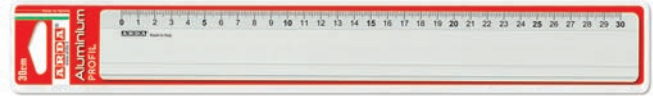

LASERTEK
INCISIONE LASER

Art.	EAN13 art.	Descrizione / Description	INNER pcs	EAN13 inner	MASTER pcs
18230	8003438182302	cm. 30	3	8003438198303	30
18240	8003438182401	cm. 40	3	8003438198402	30
18250	8003438182500	cm. 50	3	8003438198501	30
18260	8003438182609	cm. 60	3	8003438198600	30
18270	8003438182708	cm. 70	1	8003438182708	3
18280	8003438182807	cm. 80	1	8003438182807	3
182100	8003438182104	cm. 100	1	8003438182104	3

L'incisione laser garantisce l'assoluta indelebilità dei numeri e dei millimetri
Laser engraving guarantees the absolute indelibility of numbers and millimeters
La gravure au laser garantit l'indélébilité absolue des nombres et des millimètres

Righe bordo acciaio

Rulers. Stainless steel edge - Règles. Bord en acier

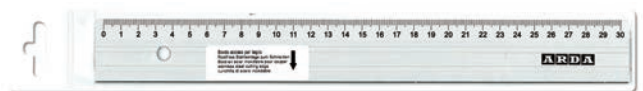

Ref. 18330 - 40 - 50 - 60 - 70 - 80 - 100 - 150

Gomma antiscivolo e tirachina
With no-sliding rubber and ink-edge
Avec patin antidérapant et bord anti-tache

Profilo di acciaio inossidabile integrato per resistere ai lavori di taglio
Integrated stainless steel profile to resist cutting jobs
Profil en acier inoxydable intégré pour résister aux travaux de coupe



Art.	EAN13 art.	Descrizione / Description	INNER pcs	EAN13 inner	MASTER pcs
18330	8003438183309	cm.30	1	8003438183309	10
18340	8003438183408	cm.40	1	8003438183408	10
18350	8003438183507	cm.50	1	8003438183507	10
18360	8003438183606	cm.60	1	8003438183606	10
18370	8003438183705	cm.70	1	8003438183705	10
18380	8003438183804	cm.80	1	8003438183804	5
183100	8003438183101	cm.100	1	8003438183101	5
183150	8003438183156	cm.150	1	8003438183156	5

Doppio e Triplo decimetro

Finger grip ruler 20-30cm
Double e triple décimètre



2 millimetrature. Impugnatura lunga.
2 graduations. Long grip.
2 graduations. Longue poignée.



Ref. 18420

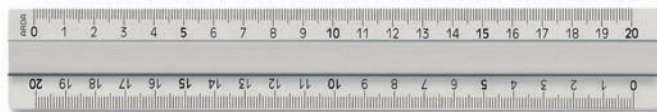

Ref. 18430



Art.	EAN13 art.	Descrizione / Description	INNER pcs	EAN13 inner	MASTER pcs
18420	8003438184207	cm. 20	3	8003438199201	30
18430	8003438184306	cm. 30	3	8003438189301	30



26
pcs

Ref. 180ESP

Display 32,5 x 25 x 57 h. cm

Espositore Display - Presentoir

DISPLAY 26 pz / pcs

Art.	EAN13 art.	Descrizione / Description	INNER	MASTER
180ESP	8003438017215	3x Sq. 45° cm. 30 - ref. 18032 3x Sq. 60° cm. 30 - ref. 18132 1x Barattolo righelli 10cm ref. 17910BAR 1x Barattolo righelli 15 cm ref. 17915BAR 6x Righe cm. 50 - ref. 18250 6x Doppio dec. cm. 20 - ref. 18420 6x Triplo dec. cm. 30 - ref. 18430	1	1

Disponibilità limitata alle campagne promozionali - Product availability limited to promotional campaigns - Disponibilité limitée aux campagnes promotionnelles

Goniometro 360°

Protractor 360° - Rapporteur 360°



Millimetrati
With graduation - Avec graduation



Art.	EAN13 art.	Descrizione / Description	INNER pcs	EAN13 inner	MASTER pcs
18715	8003438187154	360° cm. 15	1	8003438187154	10

Righe T

T-squares - Règle à "T"

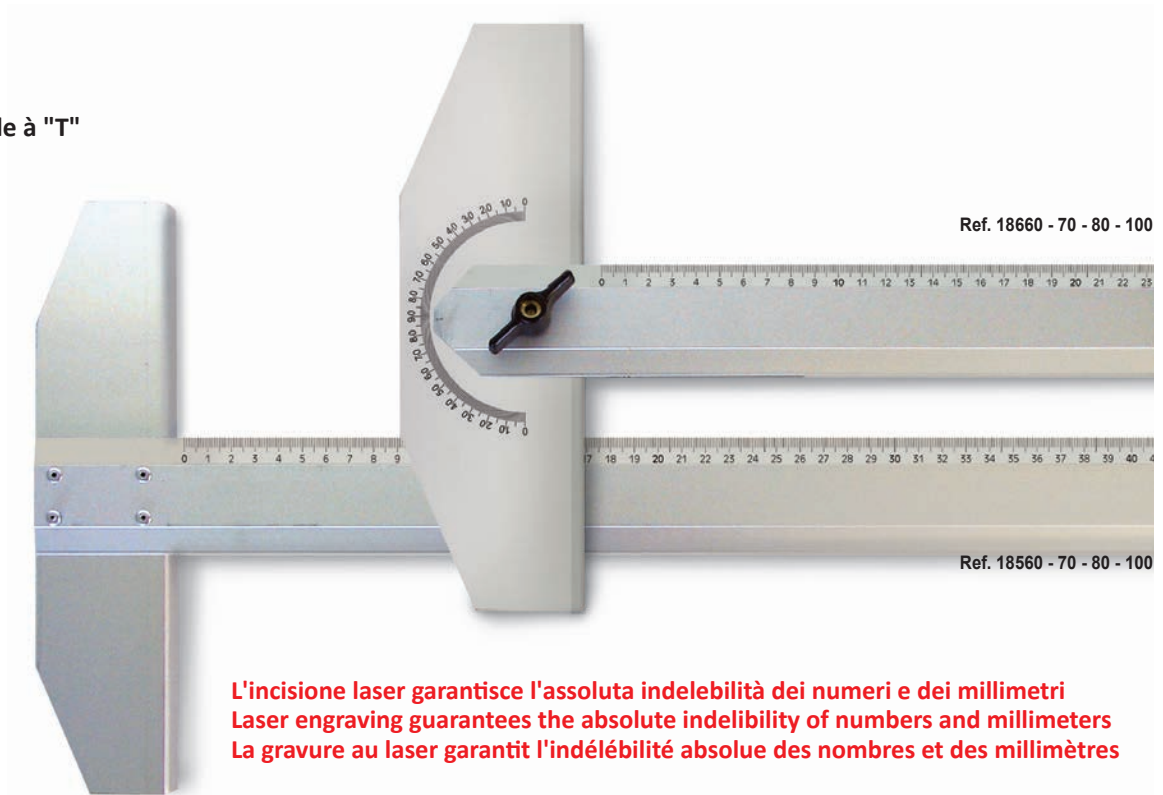

L'incisione laser garantisce l'assoluta indelebilità dei numeri e dei millimetri
Laser engraving guarantees the absolute indelibility of numbers and millimeters
La gravure au laser garantit l'indélébilité absolue des nombres et des millimètres

LASERTEK

**INCISIONE
LASER**

TESTA FISSA - Fixed head - Tête fixe

Art.	EAN13 art.	Descrizione / Description	INNER pcs	EAN13 inner	MASTER pcs
18560	8003438185600	cm.60	1	8003438185600	5
18570	8003438185709	cm.70	1	8003438185709	5
18580	8003438185808	cm.80	1	8003438185808	5
185100	8003438185105	cm.100	1	8003438185105	1

TESTA MOBILE - Mobile head - Tête mobile

Art.	EAN13 art.	Descrizione / Description	INNER pcs	EAN13 inner	MASTER pcs
18660	8003438186607	cm.60	1	8003438186607	5
18670	8003438186706	cm.70	1	8003438186706	5
18680	8003438186805	cm.80	1	8003438186805	5
186100	8003438186102	cm.100	1	8003438186102	1

Aluminium PROFIL mini



Drawing items - Articles de traçage

Barattoli righelli

Ruler containers
Pots de règles

Bordo tirachina
Ink-edge - Bord anti-tache

cm 10 - cm 15 - cm 20

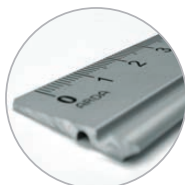

Ref. 17910BAR
15 pz

Ref. 17915BAR
15 pz

Ref. 17920BAR
15 pz

Art.	EAN13 art.	Descrizione / Description	INNER pz/pcs	EAN13 inner	MASTER pz/pcs
17910BAR	8003438007438	Bar. 15 pz - cm.10 (ean pz 8003438 015471)	1	8003438007438	12
17915BAR	8003438006981	Bar. 15 pz - cm.15 (ean pz 8003438 015457)	1	8003438006981	10
17920BAR	8003438023414	Bar. 15 pz - cm.20 (ean pz 8003438 023407)	1	8003438023414	10

Righelli Rulers - Règles

Bordo tirachina
Ink-edge - Bord anti-tache

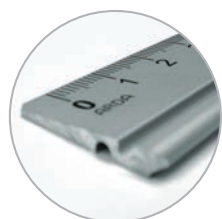

cm.10
Ref. 17910SS



cm.15
Ref. 17915SS



cm.20
Ref. 17920SS

Art.	EAN13 art.	Descrizione / Description	INNER pcs	EAN13 inner	MASTER pcs
17910SS	8003438019141	cm 10 - busta SS	10	8003438019202	10
17915SS	8003438007032	cm 15 - busta SS	10	8003438007230	10
17920SS	8003438007049	cm 20 - busta SS	10	8003438007063	10

Squadrette cm. 12 e minikit 3 pz.

Small set square cm. 12 and minikit 3 pcs.

Petites équerres cm. 12 et minikit 3 pcs

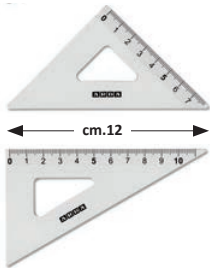

Ref. 18012
45° cm.12



Ref. 18112
60° cm.12



Ref. 80312
45° cm.12 + 60° cm.12



Ref. 1893 - Miniset 3 pz/pcs :
45° 12 cm
+ 60° 12 cm
+ Riga 15 cm

Art.	EAN13 art.	Descrizione / Description	INNER pcs	EAN13 inner	MASTER pcs
18012	8003438025685	45° cm.12	10	8003438025708	10
18112	8003438025692	60° cm.12	10	8003438025715	10
80312	8003438007414	45° + 60° cm.12	10	8003438007421	10
1893	8003438022752	miniset 3 pz/pcs	10	8003438022769	10

NUOVO CONTENUTO
NEW CONTENT - NOUVEAU CONTENU

Espositore

Display - Presentoir

10x

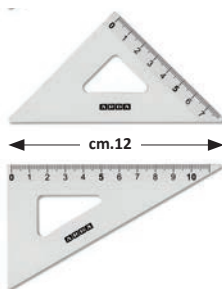

30x



40
pcs

Ref. 182ESP



Art.	EAN13 art.	Descrizione / Description	INNER pcs	EAN13 inner	MASTER pcs
182ESP	8003438031679	Display 40 pz : 30 righelli cm.15 (ean pz 8003438 015457) + 10 coppie squadre cm.12 (ref. 80312)	1	8003438031679	1

Drawing items - Articles de trousse



Aluminium Frost

Drawing items - Articles de traçage

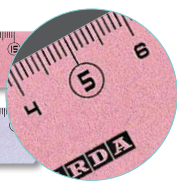
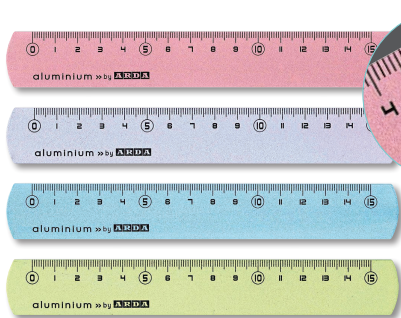

24
pcs

Ref. 17815COLBAR



24
pcs

Ref. 17820COLBAR



40
pcs

Ref. 178SQ



colori assortiti - assorted colours - couleurs assorties

Art.	EAN13 art.	Descrizione / Description	INNER pcs	EAN13 inner	MASTER pcs
17815COLBAR	8003438022127	Barattolo 24 righelli alu cm. 15 - col. ass. (ean pz 8003438022189)	1	8003438022127	10
17820COLBAR	8003438022134	Barattolo 24 righelli alu cm. 20 - col. ass. (ean pz 8003438 022196)	1	8003438022134	10
178SQ	8003438027894	Display 40 pz colori assortiti: 20x 45° cm.12 (ean pz 8003438 023285) + 20x 60° cm.12 (ean pz 8003438 023292)	1	8003438027894	1

Temperamatite in metallo

Metal pencil sharpener
Taille-crayons en metal

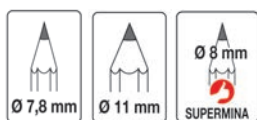

Ref. M021SC
Display 24 pcs



colori assortiti - assorted colours - couleurs assorties

Art.	EAN13 art.	Descrizione / Description	INNER pcs	EAN13 inner	MASTER pcs
M021SC	8003438028396	Temperamatite in metallo colorato in display 24 pz - col. ass. (ean display 8003438 023438)	24	8003438023438	720

Maschere e normografi

Lettering stencils, templates - Gabarits et normographes



Drawing items - Articles de tracage

The range includes the most widely-used models. The orange articles have inking edges for ink drawings, while the green articles are not bevelled and are designed for pencil drawings. The lettering stencils are suitable for use with ink and pencil and are available with characters respecting ISO and UNI standards. The rulers with lettering stencils incorporated can also be used with ballpoint pens.

Dans cette gamme il y a une sélection des modèles les plus utilisés. Les modèles en couleur ocre ont le bord-antitache pour le dessin à chine tandis que ceux en couleur vert n'en sont pas fournis car ils sont utilisés pour le dessin à crayon.

Les normographes sont utilisables soit avec la chine, soit avec le crayon. Ils sont disponibles selon les normes ISO et les normes UNI aussi. Les règles normographes et les trace-lettres peuvent être utilisés avec le stylo bille.

Sono proposti i modelli di più ampio impiego e utilizzo. Quelli in colore arancio sono muniti di ribasso per disegno con china e quelli verdi sono senza ribasso per disegno a matita. I normografi sono adatti per scrivere con la matita o con la china e sono disponibili con caratteri norme UNI e ISO. Le righe normografiche e le normosfere si utilizzano con penna a sfera.

Made in Italy

Maschere per cerchi

Circle template
Trace-cercles



Tirachina
ink-edge
bord anti-tache



Ref. 7126

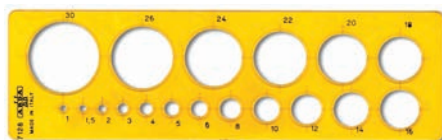

Ref. 7128

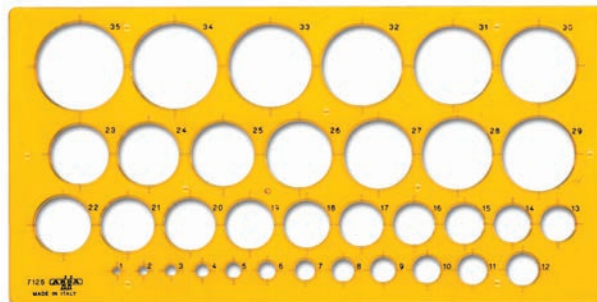

Ref. 7125

Art.	EAN13 art.	Descrizione / Description	Dimens. art.	INNER pcs	EAN13 inner	MASTER pcs
7125	8003438071255	mm. 1+35	247x124 mm	10	8003438171252	200
7126	8003438071262	mm. 1+55/80	278x141 mm	10	8003438171269	200
7128	8003438071286	mm 1+30	193x58 mm	10	8003438171283	500

Maschere per ellissi

Ellipses template
Gabarit ellipses



Tirachina
ink-edge
bord anti-tache

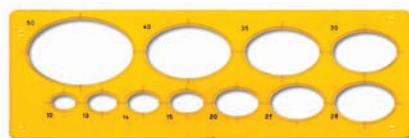

Ref. 7127

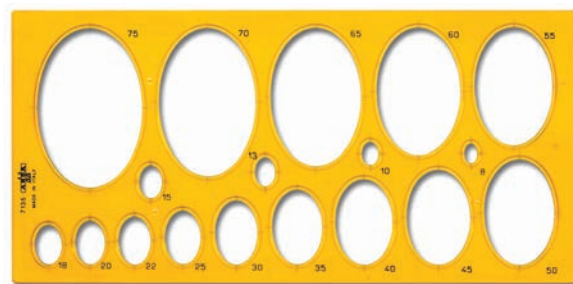

Ref. 7135

Art.	EAN13 art.	Descrizione / Description	Dimens.art.	INNER pcs	EAN13 inner	MASTER pcs
7127	8003438071279	mm. 10+50	196x63 mm	10	8003438171276	500
7135	8003438071354	mm. 8+75	270x130 mm	10	8003438171351	200

Maschere varie

Templates
Gabarits



Tirachina
ink-edge
bord anti-tache

Ref. 7149

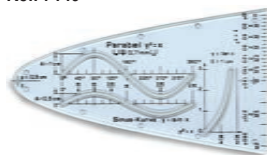

Ref. 7142

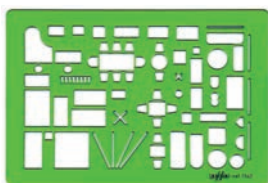

Ref. 7129

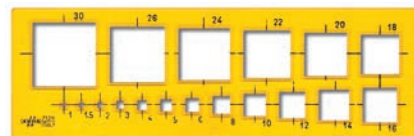

Ref. 7136

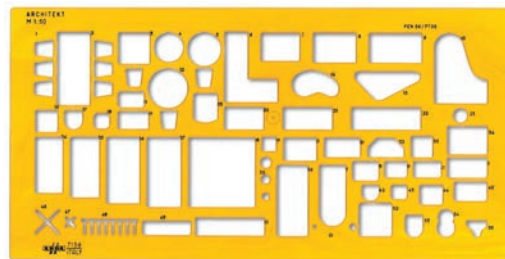

Art.	EAN13 art.	Descrizione / Description	Dimens. art.	INNER pcs	EAN13 inner	MASTER pcs
7129	8003438071293	Per quadri mm.1+30	197x63 mm	10	8003438171290	500
7136	8003438071361	Arredamento scala 1:50		10	8003438171368	10
7142	8003438071422	Arredamento scala 1:100		10	8003438171429	10
7149	8003438071491	Parabola		20	8003438171498	20

Normografi

Lettering guides
Normographe



Norme UNI - Ref. 30025 - 3 - 35 - 4 - 5 - 6 - 7 - 8 - 10 - 12 - 14



Norme ISO - Ref. 30235 - 5 - 7 - 10



NORME UNI

Art.	EAN13 art.	Descrizione / Description	INNER pcs	EAN13 inner	MASTER pcs
30025	8003438300256	h. caratteri mm.2,5	10	8003438310255	10
3003	8003438030030	h. caratteri mm.3	10	8003438031037	10
30035	8003438300355	h. caratteri mm.3,5	10	8003438310354	10
3004	8003438030047	h. caratteri mm.4	10	8003438031044	10
3005	8003438030054	h. caratteri mm.5	10	8003438031051	10
3006	8003438030061	h. caratteri mm.6	10	8003438031068	10
3007	8003438030078	h. caratteri mm.7	10	8003438031075	10
3008	8003438030085	h. caratteri mm.8	10	8003438031082	10
30010	8003438300102	h. caratteri mm.10	10	8003438310101	10
30012	8003438300126	h. caratteri mm.12	10	8003438310125	10
30014	8003438300140	h. caratteri mm.14	10	8003438311146	10

NORME ISO

Art.	EAN13 art.	Descrizione / Description	INNER pcs	EAN13 inner	MASTER pcs
30235	8003438302359	h. caratt mm.3,5	10	8003438312358	10
3025	8003438303509	h. caratteri mm.5	10	8003438313508	10
3027	8003438303707	h. caratteri mm.7	10	8003438313706	10
30210	8003438303103	h. caratteri mm.10	10	8003438313102	10

Normosfere

Lettering stencils
trace-lettre pour crayon
à bille



ref. 5006



ref. 5008



ref. 5010



PER PENNA
FOR PEN
POUR STYLO

Art.	EAN13 art.	Descrizione / Description	INNER pcs	EAN13 inner	MASTER pcs
5006	8003438500601	6 mm	10	8003438500618	10
5008	8003438500809	8 mm	10	8003438500816	10
5010	8003438050014	10 mm	10	8003438150011	10

Portamine

PER IL DISEGNO TECNICO

Drawing items - Articles de traçage



MECHANICAL PENCILS FOR TECHNICAL DRAWING

The technical models have a barrel in shock-resistant undeformable ABS and details in knurled anodised aluminium. The models with 0.5 mm leads have different characteristics depending on the price.

PORTE-MINES POUR DESSIN TECHNIQUE

Les modèles techniques ont un corps réalisé en ABS résistant aux chocs et donc indéformables. Les particuliers sont en aluminium anodisé. Les portamines avec mines de 0,5 mm ont des caractéristiques différentes par rapport aux prix.

La gamma comprende modelli che vanno dal 0.5 mm. fino a portamine per mine di 3 mm. I modelli tecnici hanno il fusto in ABS resistente agli urti e indeformabile e particolari in alluminio godronato e anodizzato. I modelli 0.5 hanno diverse caratteristiche in base alla fascia di prezzo.

Made in Italy

TURNER 4019

2 mm

Mina a caduta libera - fermaglio, pulsante e puntale in metallo. Pinzain metallo a 3 morsetti.
 With free drop lead - pocket clip, push button and tip in metal. Leads holder with metal jaws clamp.
 Mine à libre chute - clip, bouton poussoir et pointe en métal. Pince à 3 sections en métal.

Made in Italy



Sezione esagonale
 Hexagonal section
 Section hexagonale

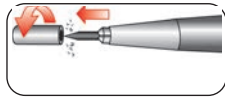

Affilamine integrato nel pulsante
 Sharpener integrated in the push button
 Aiguise-mine intégré dans le bouton poussoir.

Mina in gradazione B, Ø 2 mm, lunghezza 90 mm
 B grade lead, Ø 2 mm, length 90 mm - Mine grade B, Ø 2 mm, longueur 90 mm.



Drawing items - Articles de tracage

colori pastello



Ref. 4019PBAR
 20 pz / pcs



Art.	EAN13 art.	Descrizione / Description	INNER pcs	EAN13 inner	MASTER pcs
4019PBAR	8003438030719	Barattolo 20 portamine 2 mm pastel (ean pcs 8003438 031402)	1	8003438030719	10

colori classici



Ref. 4019CART
 Cartella / Folder / Dossier
 12 pz/pcs



Ref. 4019COLESP
 Display "Multicolour"
 12 pz/pcs



Ref. 4019BL6
 Blister



Art.	EAN13 art.	Descrizione / Description	INNER pcs	EAN13 inner	MASTER pcs
4019CART	- - -	Portamine 2 mm in cartella da 12 pz. (ean pcs 8003438 040190)	12	8003438010018	72
4019COLESP	8003438018045 (Ean display)	Display 12 pz / pcs "Multicolours" (ean pcs 8003438 040190)	1	8003438018045	10 display
4019BL6	8003438640192	Portamine 2 mm + tubetto 6 mine 2 mm in blister	20	8003438840196	20

PORTAMINE - Clutch pencil - Porte-mine

ARDA

DIAMANT 5024 max 3.0 mm UNIVERSALE

Made in Italy



Sezione ottagonale
Octagonal section
Section octogonale



Ref. 5024CART
12 pz / pcs



Ref. 5024BL6



max
3 mm
UNIVERSAL



Impugnatura antiscivolo in metallo

Non-slip metal grip zone
Zone de préhension en métal antidérapant

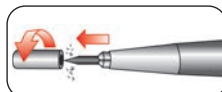

Affilamine integrato nel pulsante

Sharpener integrated in the push button
Aiguise-mine intégré dans le bouton poussoir.

Mina a caduta libera. Fermaglio, pulsante e puntale in metallo. Pinza a 4 morsetti.
Free drop lead. Pocket clip, push button and tip in metal. Leads holder 4 metal jaws clamp.
Mines à chute libre. Clip, bouton poussoir et pointe en métal. Pince à 4 sections en métal.

Art.	EAN13 art.	Descrizione / Description	INNER	EAN13 inner	MASTER
5024CART	8003438050243	Portamine fino a 3 mm in cartella da 12 pz.	12	8003438009975	72
5024BL6	8003438650245	Portamine fino a 3 mm + tubetto 6 mine 2 mm in blister	20	8003438850249	20

Mina in gradazione B, Ø 2 mm, lunghezza 90 mm - B grade lead, Ø 2 mm, length 90 mm - Mine grade B, Ø 2 mm, longueur 90 mm.

TURNER 5022 2.0 mm

Made in Italy



Sezione esagonale
Hexagonal section
Section hexagonale



Ref. 5022CART
12 pz/ pcs

Impugnatura ergonomica

Ergonomic handle
Poignée ergonomique

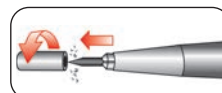

Affilamine integrato nel pulsante

Sharpener integrated in the push button
Aiguise-mine intégré dans le bouton poussoir.

Mina ad avanzamento frenato. Fermaglio, pulsante e puntale in metallo.
Push mechanism for mechanical lead advance pocket clip, push button and tip in metal.
Mines avec avance automatique - clip, bouton poussoir et pointe en métal.

Art.	EAN13 art.	Descrizione / Description	INNER	EAN13 inner	MASTER
5022CART	8003438050229	Portamine 2 mm in cartella da 12 pz.	12	8003438010087	72

Mina in gradazione B, Ø 2 mm, lunghezza 90 mm - B grade lead, Ø 2 mm, length 90 mm - Mine grade B, Ø 2 mm, longueur 90 mm.

TURNER 4017 2.0 mm

Impugnatura ergonomica

Ergonomic handle
Poignée ergonomique



Sezione tonda
Round section
Section ronde

Ean singolo per item a l'unità



Ref. 4017ESP
Display 24 pcs



Ref. 4017BL6



Anello identificazione graduazione mina
Ring to identify the graduation of the lead
Bague pour identifier la graduation de la mine

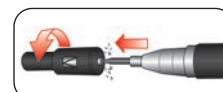

Affilamine integrato nel pulsante

Sharpener integrated in the push button
Aiguise-mine intégré dans le bouton poussoir.

Mina a caduta controllata - fermaglio e puntale in metallo. Finitura soft-touch del fusto.
Clutch pencil with spring-guided lead - clip and tip made of metal. Soft-touch finish of the barrel.
Porte-mine avec avancement automatique - clip et pointe en métal. Soft-touch finition.

Art.	EAN13 art.	Descrizione / Description	INNER	EAN13 inner	MASTER
4017ESP	8003438020109 (ean display)	Display n.24 pz. (ean pcs 8003438 020079)	1	8003438020109	8 (display)
4017BL6	8003438020840	Portamine 2 mm + tubetto 6 mine 2 mm in blister	20	8003438020857	20

LANCASTER 903 0.5 mm

Impugnatura ergonomica
Ergonomic handle
Poignée ergonomique



Sezione triangolare
Triangular section
Section triangulaire



Ean singolo/per item/à l'unité



Ref. 903ESP
12 pz / pcs



Ref. 903BL12



Gommino incorporato
Eraser incorporated
Gomme incorporée

Mina a caduta controllata. Fermaglio, pulsante e puntale in metallo.
Clutch pencil with spring-guided lead. Clip, push button and tip made of metal.
Porte-mine avec avancement automatique. Clip et pointe en métal.

Art.	EAN13 art.	Descrizione / Description	INNER	EAN13 inner	MASTER
903ESP	8003438020116 (ean display)	Display n.12 pz. (ean pcs 8003438 020086)	1	8003438020116	10 (display)
903BL12	8003438021786	Portamine 0,5 mm + tubetto 12 mine 0,5 mm in blister	20	8003438021809	20

LANCASTER 912 0.7 mm



Sezione tonda
Round section
Section ronde



Gomma - Eraser - Gomme

Ean singolo/per item/à l'unité



Ref. 912ESP
24 pz / pcs



Ref. 912BL12

Impugnatura ergonomica in gomma antiscivolo removibile
Ergonomic grip in no sliding rubber removable
Prise en main ergonomique en gomme anti-dérapant amovible

Mina a caduta controllata.
Clutch pencil with spring-guided lead.
Porte-mine avec avancement automatique.

Art.	EAN13 art.	Descrizione / Description	INNER	EAN13 inner	MASTER
912ESP	8003438020123 (ean display)	Display n.24 pz. (ean pcs 8003438 020093)	1	8003438020123	4 (display)
912BL12	8003438021793	Portamine 0,7 mm + tubetto 12 mine in blister	20	8003438021816	20

MINE Leads - Mines 2.0 mm B

n.6 mine graduazione B nere
Ø 2 mm - lunghezza 90 mm

n. 6 leads in B grade, black
Ø 2 mm - 90 mm. long.

no. 6 mines - dureté B, noir
Ø 2 mm. - Longueur 90 mm.



Ref. 5030



Ref. 5030BL

Art.	EAN13 art.	Descrizione / Description	INNER	EAN inner	MASTER
5030	...150301	tubetto 6 mine in barattolo da 15 pz.	15	...050304	180
5030BL	...503008	n.1 tubetto 6 mine in busta	20	...703002	20

MINE Leads - Mines 0.5 - 0.7 mm HB



ref. 503107

ref. 503105

Art.	EAN13 art.	Descrizione / Description	INNER	EAN inner	MASTER
503105	...020598	tubetto 12 mine 0,5 mm HB	12	...020628	12
503107	...020604	tubetto 12 mine 0,7 mm HB	12	...020635	12

AFFILAMINE A CAMPANA

Rotary lead pointer
Taille-crayon roulant

Temperamine a rotazione per mine con Ø 2 mm.
Consente due tipi di affilatura: una a punta rotonda, smussata per il disegno a mano libera e la scrittura, e una appuntita ad ago, ideale per il disegno tecnico e di precisione. Spugna per pulire la mina.

Rotary sharpener for mines Ø 2 mm.
It allows two types of sharpening: one with a round tip, suitable for freehand drawing and writing, and one pointed tip, suitable for technical and precision drawing. Sponge to clean the mine.

taille-crayon roulant pour mines Ø 2 mm.
Pour deux types d'affûtage: l'un avec pointe ronde biseauté pour dessiner et écrire, et une pointue, idéale pour les dessins techniques et précis.
Éponge pour nettoyer la mine.



Ref. TE809



Art.	EAN13 art.	Descrizione / Description	INNER pcs	EAN13 inner	MASTER pcs
TE809	8003438026217	Temperamine a campana	6	8003438026224	414

RASCHIETTO AFFILAMINE

Sandpaper scraper for leads
Recloir pour aguiser les mines



Per affilare le mine. 10 foglietti di ricambio (2 grammature) e spugna per pulire la mina.

To sharpen mine. 10 sheets for replacement (2 weights) and sponge to clean the mines.

Pour aiguiser la mine. 10 feuilles de remplacement (2 poids) et une éponge pour nettoyer la mine.

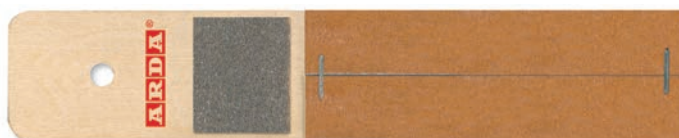

Ref. 909



Art.	EAN13 art.	Descrizione / Description	INNER pcs	EAN13 inner	MASTER pcs
909	8003438014795	Raschietto affilamine	20	8003438014801	200

GUARDA CHE RIGHE!

Drawing items - Articoli de traccage

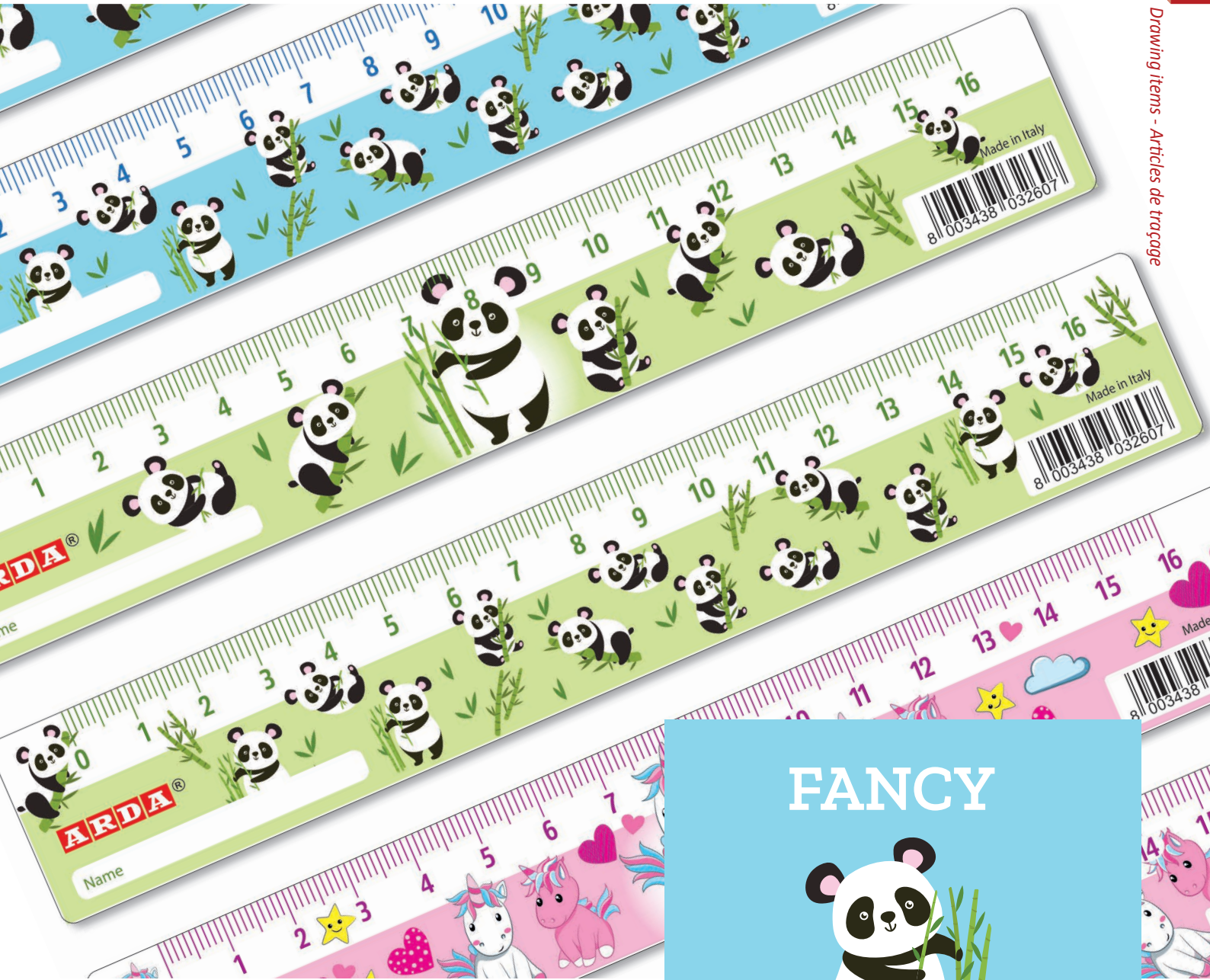



DISPLAY DA BANCO "VOILÀ"
Desk display - Présentoir de comptoir



Display PELUCHE
ref. 1650002

- 24 Tenks Peluche
- 24 righelli cm.16 Fluo

Ean 8003438 032645



Display GLITTER
ref. 1650003

- 24 Tenks Glitter
- 24 righelli cm.16 Fluo

Ean 8003438 032652

Temperamatite TENKS
+ righelli coordinati
TENKS sharpener + matching ruler
Taille-crayons TENKS + règle coordonnée



Display FANCY
ref. 1650001

- 24 Tenks Fancy
- 24 righelli cm.16 Fancy

Ean 8003438 032638

Barattolo 24 righelli FANCY

Pot containing 24 rulers
Pot de 24 règles

16 cm



>> GO pg. 95

24 pcs Ref. R17DBAR
Ean singolo/per item/à l'unité



Art.	EAN13 art.	INNER	EAN13 inner	MASTER
R17DBAR	8003438032614	1	8003438032614	10

Decorì ass. - Ass. decoration - Décors ass. - Articolo singolo / Each articles / Article à l'unité : 8003438 032607

Barattolo 24 righelli FLUO

Pot containing 24 rulers
Pot de 24 règles

16 cm



>> GO pg. 95

Puntatore compasso
Hole to point in compass
Pointeur pour compas

24 pcs Ref. R17FLBAR
Ean singolo/per item/à l'unité



Art.	EAN13 art.	INNER	EAN13 inner	MASTER
R17FLBAR	8003438032577	1	8003438032577	10

Colorì ass. - Ass. colours - Couleurs ass. - Articolo singolo / Each articles / Article à l'unité : 8003438 026194

Barattolo 24 righelli

Pot containing 24 rulers
Pot de 24 règles

16 cm

Righelli con tabelline, formule geometriche e tabelle conversioni.

Rulers with multiplication tables, geometric formulas and conversion tables.

Règles avec tables de multiplication, formules géométriques et tables de conversion.



>> GO pg. 104



MATHEMATICS

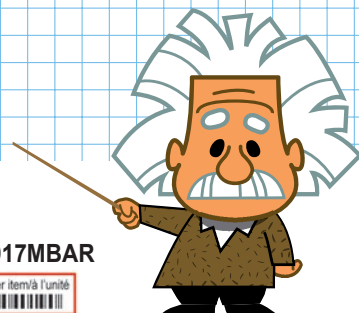

24 pcs

Ref. 28917MBAR



Ean singolo/per item/và l'unità

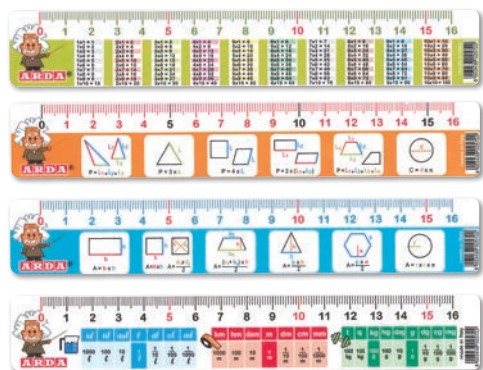

Art.	EAN13 art.	INNER	EAN13 inner	MASTER
28917MBAR	8003438025791	1	8003438025791	10

Soggetti assortiti - assorted subjects - sujets assorties - Articolo singolo / Each articles / Article à l'unité : 8003438 025722

Barattolo 24 righelli

Pot containing 24 rulers
Pot de 24 règles

16 cm



Articoli ecosostenibili in
PLASTICA RICICLATA
RECYCLED PLASTIC



>> GO pg. 100



24 pcs

Ref. R17REBAR



Ean singolo/per item/và l'unità



Art.	EAN13 art.	INNER	EAN13 inner	MASTER
R17REBAR	8003438029546	1	8003438029546	10

Soggetti assortiti - assorted subjects - sujets assorties - Articolo singolo / Each articles / Article à l'unité : 8003438 029560



IL SEGNA RIGA

RIGHELLO PER LETTURA GUIDATA SPECIALE PER DISLESSICI

STRUMENTO DIDATTICO COMPENSATIVO SPECIALE PER DSA

Uno strumento semplice ed efficace. La parte colorata maschera le altre righe lasciando scoperta solo quella da leggere. Favorisce la concentrazione e allevia lo stress visivo. Speciale per DSA. Display con modelli e colori assortiti (5 mm - 7 mm - 10 mm).

COMPENSATORY EDUCATIONAL TOOL - SPECIAL FOR DSA

A simple and effective tool. The colored part masks the other lines, leaving only the one to be read uncovered. Promotes concentration and relieves eye strain. Special for DSA. Display with assorted colours and models(5mm - 7mm - 10 mm).

OUTIL PÉDAGOGIQUE COMPENSATOIRE - SPÉCIAL POUR DSA

Un outil simple et efficace. La partie colorée masque les autres lignes, ne laissant que celle à lire découverte. Favorise la concentration et soulage la fatigue oculaire. Spécial pour DSA. Display avec modèles et couleurs assorties (5mm - 7mm - 10 mm).



36
pcs
Ref. R17DI



Ref. R17DISS

Art.	EAN13 art.	Descrizione / Description	INNER	EAN13 inner	MASTER
R17DI	8003438032072	Display 36 pz "SEGNA RIGA" - assortiti nei colori e nelle misure (Ean pz. h.5 mm 8003438032065 - Ean pz. h.7 mm 8003438032188 Ean pz.h.10 mm 8003438032195)	1	8003438032072	1
R17DISS	8003438032836	SEGNARIGA in busta SS - assortiti nei colori e nelle misure	10	8003438032843	10

Dimensione righello - Ruler - Règle : 183 x 30 mm

Serie FANCY

Espositore 45 pz.righelli cm.16 FANTASY

Display 45 pcs. Ruler cm.16
Presentoir 45 pcs. Règle cm.16

NEW
fantasy

Drawing items - Articles de traçage



45 pcs
Ref. 28917DESP
Ean singolo/per item/à l'unité



Ref. 28917DSS

Decori assortiti - Assorted decoration - Décors assortis

Art.	EAN13 art.	Descrizione / Description	INNER pcs	EAN13 inner	MASTER pcs
28917DESP	8003438014146	Display 45 righelli cm.16 FANTASY (Ean pz 8003438014191)	1	8003438014146	1
28917DSS	8003438014658	Riga cm.16 FANTASY in busta SS	20	8003438014665	800

Espositore 45 righelli cm.16 FANTASY BLACK

Display 45 pcs. Ruler cm.16
Presentoir 45 pcs. Règle cm.16



45 pcs
Ref. 28917DESPSK
Ean singolo/per item/à l'unité



>> GO pg. 100

Art.	EAN13 art.	Descrizione / Description	INNER pcs	EAN13 inner	MASTER pcs
28917DESPSK	8003438020697	Display 45 righelli cm.16 (Ean pz 8003438020734)	1	8003438020697	1

Espositore 25 pz. righe cm.30 FANTASY

Display 25 pcs. Ruler cm.30
Presentoir 25 pcs. Règle cm.30



Ref. 28930DSS



25 pcs
Ref. 28930DESP
Ean singolo/per item/à l'unité

Decori assortiti - Assorted decoration - Décors assortis

Art.	EAN13 art.	Descrizione / Description	INNER pcs	EAN13 inner	MASTER pcs
28930DESP	8003438015488	Display 25 pz righe cm.30 EMOTION (Ean pz 8003438 014894)	1	8003438015488	1
28930DSS	8003438014887	Riga cm.30 EMOTION in busta SS	20	8003438015327	360

Espositore 32 righelli cm.16

Display 32 pcs. Ruler cm.16 - Presentoir 32 pcs. Règle cm.16

#KEEP COLOUR
diamant

EFFETTO METALLO
METAL FEELING
EFFET METAL



32 pcs
Ref. R17KCDESP
Ean singolo/per item/à l'unité



>> GO pg. 99

Art.	EAN13 art.	Descrizione / Description	INNER pcs	EAN13 inner	MASTER pcs
R17KCDESP	8003438025784	Display 32 righelli cm.16 KEEP COLOUR DIAMANT (Ean pz 8003438024800)	1	8003438025784	1

Colori assortiti - Assorted colours - Couleurs assorties

Serie FANCY

Left & Right

Doppia graduazione. Ideale anche per mancini.
 Double graduation. Also ideal for left-handed people.
 Double graduation. Idéal également pour les gauchers.



ref. 115ESP
15 pz/pcs
righello cm.15



ref. 117ESP
Display mix 45 pz/pcs

Art.	EAN13 art.	Descrizione / Description	INNER pcs	EAN13 inner	MASTER pcs
115ESP	8003438029355	Display 15 righelli/rulers/règles cm.15 (ean pcs 8003438 029324)	1	8003438029355	1
117ESP	8003438030634	Display 45 pz/pcs : 15x miniset + 15x R15cm + 15x R30 cm	1	8003438030634	1



cm.30



cm.15



miniset 3 pz/pcs

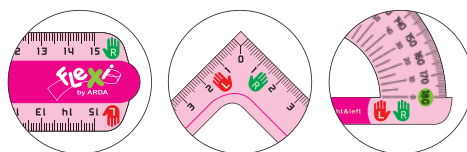

ref.115

ref.131



ref.130

Art.	EAN13 art.	Descrizione / Description	INNER pcs	EAN13 inner	MASTER pcs
115	8003438029324	Riga FLEXI cm.15 Left&Right	15	8003438029331	300
130	8003438030405	Riga FLEXI cm.30 Left&Right	15	8003438030429	300
131	8003438030412	Miniset 3 pz/pcs : R15 + 60°cm15+180°cm10	15	8003438030436	300

Colori assortiti - Assorted colours - Couleurs assorties