



## GRAZIE PER AVER ACQUISTATO UN PRODOTTO

### HOTPOINT - ARISTON

Per ricevere un'assistenza più completa,  
registrare il prodotto su  
[www.hotpoint.eu/register](http://www.hotpoint.eu/register)



Scaricare le istruzioni per la sicurezza e le  
istruzioni per l'uso collegandosi al sito  
[www.hotpoint.eu](http://www.hotpoint.eu) e seguire la procedura  
indicata sul retro.



**Leggere attentamente le istruzioni per la sicurezza prima di utilizzare il prodotto**

## DESCRIZIONE PRODOTTO

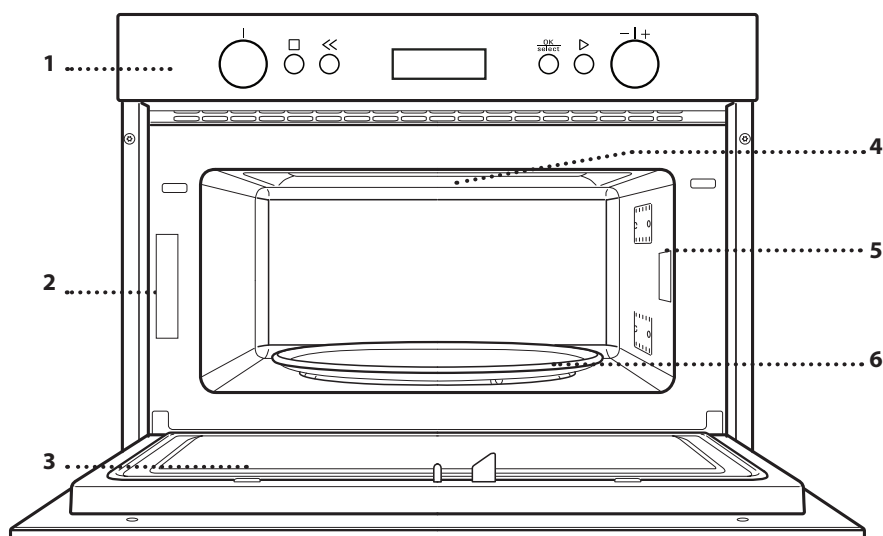

1. Pannello di controllo
2. Targhetta matricola  
(da non rimuovere)
3. Porta
4. Resistenza superiore / grill
5. Luce
6. Piatto rotante

## PANNELLO DI CONTROLLO

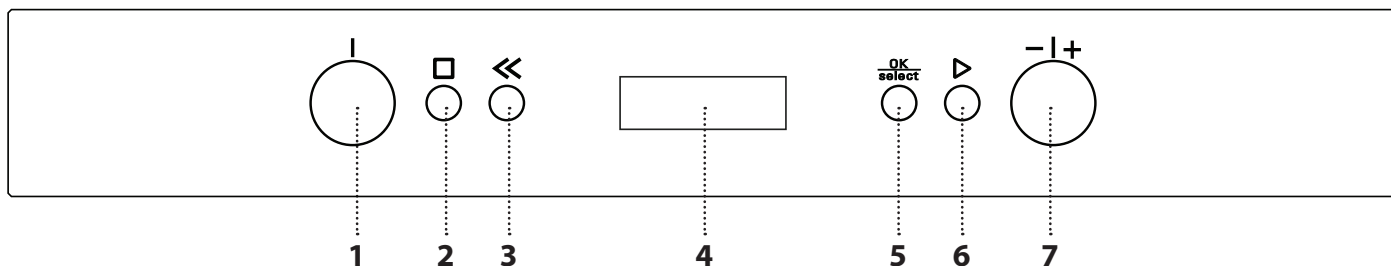

### 1. MANOPOLA DI SELEZIONE

Per accendere il forno selezionando una funzione. Per spegnere il forno, ruotare sulla posizione "0".

### 2. STOP

Per interrompere in ogni momento una funzione attiva e mettere in stand-by il forno.

### 3. INDIETRO

Per tornare alla schermata precedente.

### 4. DISPLAY

### 5. TASTO DI CONFERMA

Per confermare la selezione di una funzione o un valore impostato.

### 6. TASTO DI CONFERMA

Per avviare immediatamente una funzione. A forno spento, avvia la funzione microonde "Jet Start".

### 7. MANOPOLA DI REGOLAZIONE

Per scorrere i menu, impostare o modificare i valori.

Nota: le manopole sono a scomparsa; premere al centro delle stesse per estrarle dalla loro sede.

## PIATTO ROTANTE

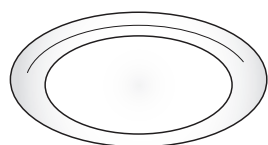

Appoggiato sull'apposito supporto, il piatto rotante in vetro può essere utilizzato in tutte le modalità di cottura.

Il piatto rotante va sempre usato come base per altri contenitori o accessori ad eccezione della teglia rettangolare.

## SUPPORTO PIATTO ROTANTE

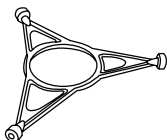

Utilizzare l'apposito supporto solo per appoggiare il piatto rotante in vetro: non appoggiare altri accessori sopra il supporto.

## PIATTO CRISP

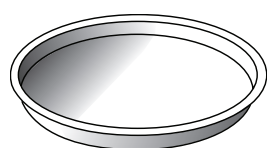

Da usarsi solo con l'apposita funzione.

Il piatto Crisp deve essere sempre appoggiato al centro del piatto rotante in vetro e può essere preriscaldato a vuoto, utilizzando solo la speciale funzione dedicata. Disporre gli alimenti direttamente sul piatto Crisp.

## MANIGLIA PER PIATTO CRISP

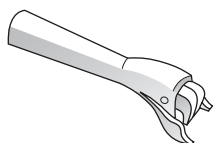

Utile per rimuovere il piatto Crisp caldo dal forno.

## GRIGLIA

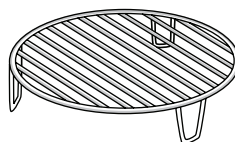

Permette di avvicinare il cibo al grill, assicurandone una piacevole doratura. Appoggiare la griglia sul piatto rotante, evitando che venga a contatto con altre superfici.

## COPERCHIO

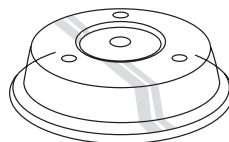

Utile per coprire i recipienti durante la cottura e il riscaldamento a microonde. Il coperchio permette di ridurre gli schizzi, trattenere l'umidità degli alimenti e può essere

utilizzato anche per creare due livelli di cottura. Non è adatto alle cotture che attivano il grill (compreso "Crisp Dynamic").

Il numero di accessori può variare a seconda del modello acquistato.

È possibile acquistare separatamente altri accessori presso il Servizio Assistenza Clienti.

**In commercio sono disponibili diversi accessori: prima di acquistarli, accertarsi che siano idonei alla cottura a microonde e resistenti al calore del forno.**

**Contenitori metallici per cibi o bevande non vanno mai usati durante una cottura a microonde.**

**Verificare che alimenti e accessori non tocchino le pareti interne del forno.**

**Prima di avviare il forno, assicurarsi sempre che il piatto rotante possa ruotare liberamente. Fare attenzione a non spostare il piatto rotante dalla sua sede mentre si inseriscono o rimuovono altri accessori.**

**MICROONDE**  
Per cuocere e riscaldare rapidamente alimenti o bevande.

POTENZA	CONSIGLIATA PER
<b>1000 W</b>	Riscaldamento rapido di bevande o altri alimenti ad alto contenuto di acqua
<b>800 W</b>	Cottura di vegetali
<b>650 W</b>	Cottura di carne e pesce
<b>500 W</b>	Cottura di sughi di carne, salse con formaggio o uova. Finitura di sfornati di carne o paste al forno
<b>350 W</b>	Cotture lente e delicate. Per fondere burro o cioccolato
<b>160 W</b>	Scongelare alimenti surgelati o ammorbidire burro e formaggi
<b>90 W</b>	Ammorbidire il gelato

Accessorio suggerito: **copercchio**

**CRISP DYNAMIC**  
Per ottenere una doratura perfetta sia sulla superficie superiore che su quella inferiore del cibo. Questa funzione richiede esclusivamente l'utilizzo dello speciale piatto Crisp.

Accessorio necessario: **piatto crisp, maniglia per piatto crisp**

**GRILL**  
Per dorare, grigliare o gratinare le pietanze. Si consiglia di girare gli alimenti durante la cottura. Si raccomanda di preriscaldare il grill per 3-5 minuti.

Accessorio suggerito: **griglia**

**GRILL + MICROONDE**  
Per cuocere e gratinare rapidamente le pietanze combinando le microonde con il grill.

Accessorio suggerito: **griglia**

## AUTO FUNZIONI AUTOMATICHE

Con le funzioni automatiche è sufficiente specificare tipo e il peso o la quantità degli alimenti per ottenerne un risultato ottimale. Il forno calcolerà automaticamente i valori ideali, adattandosi continuamente alla cottura in corso.

**DEFROST DYNAMIC**  
Per scongelare rapidamente gli alimenti con un peso compreso tra 100g e 3 kg. Si consiglia di disporre gli alimenti direttamente sul piatto rotante in vetro. Girare gli alimenti quando richiesto.

CATEGORIA	ALIMENTI CONSIGLIATI	PESO
1*	CARNE (macinato, cotolette, bistecche, arrostiti)	100 g - 2 kg
2*	POLLAME (pollo intero, a pezzi, filetti)	100 g - 2,5 kg
3*	PESCE (Intero, tranci, filetti)	100 g - 1,5 kg
4*	VEGETALI (Verdure miste, piselli, broccoli...)	100 g - 1,5 kg
5*	PANE (Pagnotte, focaccine, panini)	100 g - 1 kg

**REHEAT DYNAMIC**  
Per riscaldare cibi pronti, sia surgelati che a temperatura ambiente. Il forno calcolerà automaticamente i valori necessari per ottenere i migliori risultati possibili nel minor tempo. Disporre il cibo su un piatto da portata resistente al calore e alle microonde.

CATEGORIA	ALIMENTO	PESO
1	PIATTI PRONTI	250 g - 500 g
2*	PORZIONI SURGELATE	250 - 500 g
3*	LASAGNE SURGELATE	250 - 500 g
4	ZUPPE	200 - 800 g
5	BEVANDE	1 - 5 dl

## FUNZIONI AUTOMATICHE



AUTO

### CRISP DYNAMIC

Per riscaldare e cuocere rapidamente alimenti surgelati, creando una superficie dorata e croccante. Usare la funzione solo in combinazione con il piatto Crisp in dotazione. Girare gli alimenti quando richiesto.

CATEGORIA	ALIMENTO	PESO
 1*	PATATINE FRITTE (Da distribuire su un unico strato e cospargere con sale prima della cottura)	200 - 500 g
 2*	PIZZA, CROSTA SOTTILE	200 - 600 g
 3*	PIZZA, CROSTA SPESSA	300 - 800 g
 4*	ALI DI POLLO, BOCCONCINI DI POLLO (Ungere leggermente il piatto)	200 - 500 g
 5*	BASTONCINI DI PESCE (Richiede preriscaldamento del piatto crisp)	100 - 500 g





Accessorio necessario: piatto crisp, maniglia per piatto crisp



AUTO

### COOK DYNAMIC

Per ottenere una rapida e ottimale cottura al forno degli alimenti. Usare un recipiente adatto alla cottura in forno e resistente alle microonde.

CATEGORIA	ALIMENTO	PESO
 1	PATATE AL FORNO (Girare quando richiesto)	200 g - 1 kg
 2	VERDURE FRESCHE (Tagliare uniformemente e aggiungere 2/4 cucchiaini di acqua. Coprire)	200 - 800 g
 3*	VERDURE SURGELATE (Girare quando richiesto. Coprire)	200 - 800 g
 4	VERDURE IN SCATOLA	200 - 600 g
 5	POPCORN	100 g



### IMPOSTAZIONI

Per modificare le impostazioni del forno (lingua, orologio, volume del segnale acustico, luminosità, modalità ECO).

Nota: quando è attiva la modalità ECO, la luminosità del display si abbassa dopo alcuni secondi per risparmiare energia. Si riattiva automaticamente dopo ogni interazione.

## PRIMO UTILIZZO

### 1. SELEZIONARE LA LINGUA

Alla prima accensione, è necessario impostare lingua e ora: sul display scorre la scritta "ENGLISH": ruotare la manopola di regolazione per scorrere la lista delle lingue disponibili e selezionare quella desiderata.



Premere **OK select** per confermare la selezione.

Nota: è possibile modificare in seguito la lingua dal menu "Impostazioni".

### 2. IMPOSTARE L'ORA

Dopo aver selezionato la lingua, sarà necessario impostare l'ora corrente: sul display lampeggiano le due cifre relative all'ora.

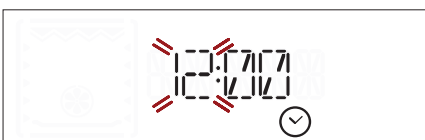

Ruotare la manopola di regolazione per impostare l'ora desiderata e premere **OK select**: sul display lampeggiano i minuti.

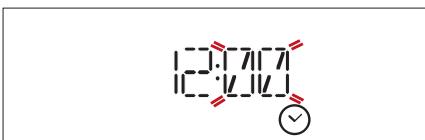

Ruotare la manopola di regolazione per impostare i minuti e premere **OK select** per confermare.

Nota: dopo una prolungata interruzione di corrente potrebbe essere necessario impostare nuovamente l'ora. Durante il primo utilizzo, o dopo una prolungata interruzione di corrente, accertarsi che la porta del forno sia chiusa prima di effettuare l'impostazione della lingua o dell'ora.

# USO QUOTIDIANO

## 1. SELEZIONARE UNA FUNZIONE

Ruotare la *manopola di selezione* fino a quando viene visualizzata sul display la funzione desiderata: il display mostra l'icona della funzione e i valori di base.



Dove presente, per selezionare una voce di menu (il display mostra la prima voce disponibile) ruotare la *manopola di regolazione* fino a visualizzare la voce desiderata.



Premere **OK select** per confermare la selezione: il display mostra i valori di base.

## 2. IMPOSTARE LA FUNZIONE

Dopo aver selezionato la funzione desiderata, è possibile modificare i valori. Il display mostra in sequenza i valori che è possibile modificare.



Quando il valore lampeggia sul display, ruotare la *manopola di regolazione* per modificarlo, quindi premere **OK select** per confermare e procedere con le impostazioni seguenti.

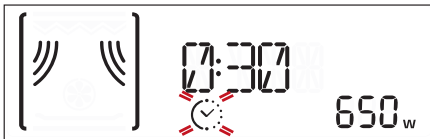

Nota: premendo **←** è possibile modificare nuovamente il valore precedente.

## 3. AVVIARE LA FUNZIONE

Una volta che i valori corrispondono a quelli desiderati, premere **▶** per avviare la funzione.



Premere **□** per interrompere in ogni momento la funzione attivata.

## .BLOCCO DI SICUREZZA

Questa funzione si attiva automaticamente per prevenire un avvio involontario del forno.

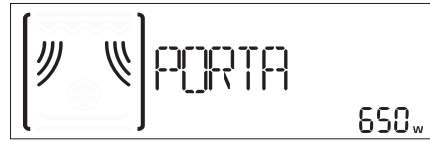

Aprire e chiudere la porta, poi premere **▶** per avviare la funzione.

## .PAUSA

Per sospendere una funzione attiva, per esempio per mescolare o girare gli alimenti, è sufficiente aprire la porta.

Per riprendere, chiudere la porta e premere **▶**.

## .JET START

A forno spento, premere **▶** per avviare la cottura con la funzione microonde impostata alla potenza massima (1000W) per 30 secondi.

Ogni pressione successiva del tasto **▶** aumenterà la durata di cottura di ulteriori 30 secondi.

## FUNZIONI AUTOMATICHE

### CATEGORIE

Quando si utilizzano alcune funzioni automatiche, occorre selezionare la categoria di cibo alla quale appartiene l'alimento.

La categoria di riferimento corrisponde al numero indicato nella parte in alto a destra del display.



Consultare la tabella di descrizione delle funzioni per conoscere tutte le categorie.

### GRADO DI COTTURA

Nella maggior parte delle funzioni automatiche viene richiesto il grado di cottura del cibo che si desidera ottenere.

Il grado di cottura desiderato può essere modificato durante i primi 20 secondi dall'avvio della funzione: dopo aver avviato la funzione, ruotare la *manopola di regolazione* per scegliere l'impostazione desiderata.



## AZIONI (MESCOLARE O GIRARE GLI ALIMENTI)

Alcune funzioni automatiche prevedono delle pause per consentire di girare o mescolare gli alimenti.



Quando il forno interrompe la cottura, aprire la porta per eseguire le operazioni indicate, quindi chiuderla e premere ► per riprendere la cottura.

Nota: durante la funzione "Dynamic defrost", dopo 2 minuti, anche se gli alimenti non sono stati girati o mescolati la funzione riprenderà automaticamente.

## . TIMER

Solo quando il forno è spento, è possibile attivare il timer. Per attivare la funzione e impostare la durata desiderata, ruotare la *manopola di regolazione*.



Premere **OK select** per avviare il timer: un segnale acustico e il display avviseranno del termine del conto alla rovescia.





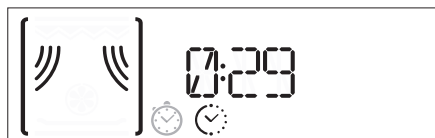







































Note: il timer non attiva nessun ciclo di cottura. Per modificare il timer ruotare la *manopola di regolazione*, per interromperlo e tornare a visualizzare l'ora corrente premere ◀◀.

Una volta attivato il timer, è possibile attivare una funzione: il timer continuerà autonomamente il conto alla rovescia senza interferire sulla funzione.



Per tornare a visualizzare il timer, attendere il termine della funzione o spegnere il forno premendo ①.







# TABELLA DI COTTURA

ALIMENTI	FUNZIONE	POTENZA (W)	TEMPO (MIN)	ACCESSORI
Torta tipo pan di Spagna		-	7 - 15	
Crostata di frutta		-	12 - 20	
Biscotti		-	4 - 6	
Torte salate o Quiche lorraine (1 - 1,2 kg)		-	18 - 25	
Piatti pronti (250 - 500 g)		800	4 - 7	-
Lasagne / Pasta al forno		350 - 500	15 - 25	 
Lasagne surgelate (500 - 700 g)		500 - 800	14 - 20	-
Pizza (400 - 500 g)		-	10 - 12	
Carne (braciole, bistecche)		500	10 - 15	 
Pollame (intero, 800 g - 1,5 kg)		350 - 500	30 - 45 *	 
Pezzi o filetti di pollo		350 - 500	10 - 17	 
Arrosti (800 g - 1,2 kg)		350 - 500	25 - 40 *	 
Salsicce / Spiedini		-	20 - 40 *	
Salsicce / Hamburger		-	6 - 16 *	 **
Pesce (tranci o filetti)		160 - 350	15 - 20 *	 
Pesce intero (800 g - 1,2 kg)		160 - 350	20 - 30 *	 
Patate al forno (600 g - 1 kg)		350 - 500	30 - 50 *	 
Patate a spicchi (500 g - 800 g)		-	20 - 30	
Mele al forno		160 - 350	15 - 25	 

\* Girare gli alimenti a metà cottura

\*\* Preriscaldare il piatto crisp per 3-5 minuti

 Scaricare le Istruzioni per l'uso da [www.hotpoint.eu](http://www.hotpoint.eu) per consultare la tabella delle ricette testate, compilata per gli istituti di valutazione secondo la norma IEC 60350

FUNZIONI	Crisp 	Grill 	Grill + Microonde 
ACCESSORI	Piatto / contenitore adatto alle microonde e al calore 	Griglia 	Piatto Crisp 

# PULIZIA

**Assicurarsi che il forno si sia raffreddato prima di eseguire ogni operazione.**

**Non utilizzare pulitrici a getto di vapore.**

**Non usare pagliette metalliche, panni abrasivi e detergenti abrasivi o corrosivi che possano danneggiare le superfici.**

## SUPERFICI ESTERNE

- Pulire le superfici con un panno umido. Se molto sporche, aggiungere qualche goccia di detergente neutro. Asciugare con un panno asciutto.
- Pulire il vetro della porta con detergenti liquidi specifici.
- A intervalli regolari o in caso di traboccamenti, togliere il piatto rotante e il suo supporto per pulire la base del forno, rimuovendo tutti i residui di cibo.
- Il grill non necessita di alcuna pulizia perché il calore intenso brucia direttamente lo sporco: attivare la funzione a intervalli regolari.

## ACCESSORI

È possibile lavare in lavastoviglie tutti gli accessori ad eccezione del piatto Crisp. Il piatto Crisp deve essere pulito con acqua e un detergente neutro. Per lo sporco più tenace, strofinare delicatamente con un panno. Far raffreddare il piatto Crisp prima di lavarlo.

# RISOLUZIONE DEI PROBLEMI

Problema	Possibile causa	Soluzione
Il forno non funziona	Interruzione di corrente elettrica Disconnessione dalla rete principale	Verificare che ci sia tensione in rete e che il forno sia collegato all'alimentazione elettrica Spegnere e riaccendere il forno e verificare se l'inconveniente persiste.
Il forno fa rumore anche se spento	Ventola di raffreddamento attiva	Aprire la porta o attendere la fine del raffreddamento.
Il display mostra "Err"	Guasto software	Contattare il più vicino Servizio Assistenza Clienti e specificare la lettera o il numero che segue "Err".

## SCHEDA TECNICA

 [www](http://www.hotpoint.eu) La scheda del prodotto comprensiva dei dati energetici di questo forno può essere scaricata dal sito internet [www.hotpoint.eu](http://www.hotpoint.eu)

## COME OTTENERE LE ISTRUZIONI PER L'USO

>  [www](http://www.hotpoint.eu) Scaricare le istruzioni per l'uso dal sito internet [www.hotpoint.eu](http://www.hotpoint.eu) (è possibile usare questo QR Code) indicando il codice commerciale del prodotto.



> In alternativa, contattare il Servizio di Assistenza Clienti

## CONTATTARE IL SERVIZIO ASSISTENZA CLIENTI

I contatti possono essere trovati sul manuale di garanzia. Quando si contatta il Servizio di Assistenza Clienti fornire i codici presenti sulla targhetta matricola del prodotto.

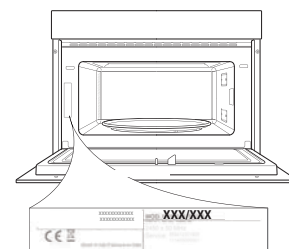



# GUIA DE CONSULTA DIÁRIA



## OBRIGADO POR ADQUIRIR UM PRODUTO HOTPOINT - ARISTON

Para receber mais informações e assistência, registe o seu produto em [www.hotpoint.eu/register](http://www.hotpoint.eu/register)



Transfira o Guia de Utilização e Manutenção a partir do nosso website [www.hotpoint.eu](http://www.hotpoint.eu) e siga as instruções no verso deste livro.



**Antes de utilizar o produto, leia atentamente as instruções de segurança**

## DESCRIÇÃO DO PRODUTO

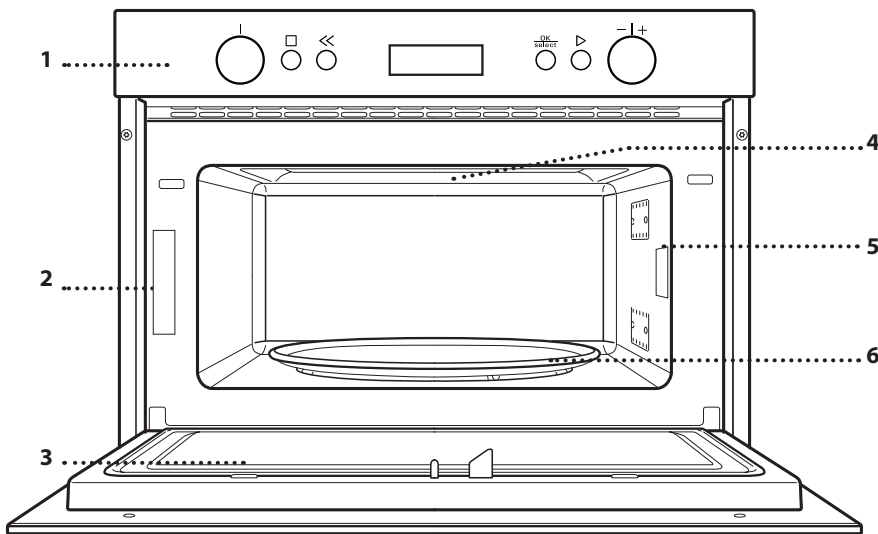

1. Painel de controlo
2. Placa de identificação (não remover)
3. Porta
4. Resistência superior/grelhador
5. Luz
6. Prato rotativo

## PAINEL DE CONTROLO

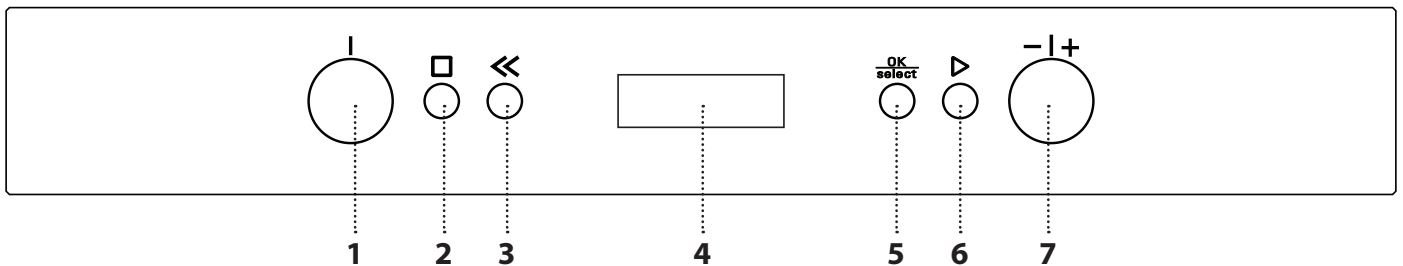

### 1. BOTÃO SELETOR

Para ligar o forno selecionando uma função. Para desligar o forno, rode o botão para a posição "0".

### 2. STOP

Para parar, a qualquer altura, a função que estiver ativada nesse momento e colocar o forno em modo de espera.

### 3. RETROCEDER

Para regressar ao menu anterior.

### 4. VISOR

### 5. BOTÃO DE CONFIRMAÇÃO

Para confirmar a seleção de uma função ou de um valor definido.

### 6. BOTÃO DE CONFIRMAÇÃO

Para iniciar imediatamente uma função. Se o forno estiver desligado, ativa a função do micro-ondas "Jet Start".

### 7. BOTÃO DE AJUSTE

Para percorrer os menus e aplicar ou alterar as definições.

Lembre-se: Todos os botões rotativos são retráteis. Pressione o centro do botão para libertá-lo.

## PRATO ROTATIVO

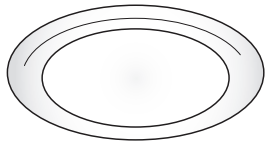

Colocado no respetivo suporte, o prato rotativo de vidro pode ser utilizado com todos os métodos de cozedura.

O prato rotativo tem sempre de ser utilizado como base para outros recipientes ou acessórios, à exceção do tabuleiro de assar retangular.

## SUPORTE DO PRATO ROTATIVO

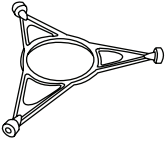

Utilize apenas o suporte para o prato rotativo de vidro. Não apoie outros acessórios no suporte.

## PRATO CRISP

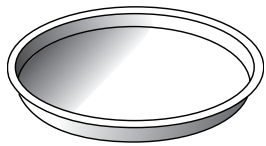

Apenas para utilização com a função designada.

O prato Crisp tem sempre de ser posicionado no centro do prato rotativo de vidro e pode ser pré-aquecido quando estiver vazio, utilizando a função especial exclusiva para este efeito. Coloque os alimentos diretamente no prato Crisp.

## MANÍPULO PARA O PRATO CRISP

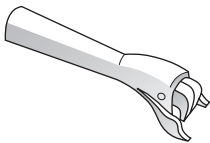

Útil para retirar o prato Crisp quente do forno.

## GRELHA

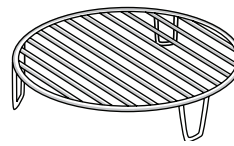

Permite colocar os alimentos mais próximos do grelhador para obter um prato perfeitamente dourado. Coloque a grelha sobre o prato rotativo, certificando-se de

que esta não entra em contacto com outras superfícies.

## TAMPA

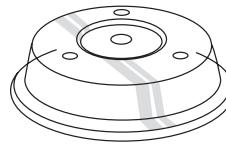

Útil para tapar recipientes durante a cozedura/aquecimento em micro-ondas.

A tampa reduz os salpicos, mantém a humidade dos alimentos e também pode ser utilizada para criar dois níveis de cozedura. Não deve ser utilizado com nenhuma das funções do grelhador (incluindo a função "Crisp Dynamic").

O número de acessórios pode variar de acordo com o modelo adquirido.

Pode adquirir separadamente outros acessórios no Serviço Pós-venda.

Existem vários acessórios disponíveis no mercado. Antes de os comprar, certifique-se de que estes são adequados para serem utilizados no micro-ondas e que são resistentes às temperaturas do forno.

Os recipientes metálicos para alimentos ou bebidas nunca devem ser utilizados na função de micro-ondas.

Certifique-se sempre de que os alimentos e os acessórios não entram em contacto com as paredes interiores do forno.

Antes de ligar o forno certifique-se sempre de que o prato rotativo consegue rodar livremente. Tenha cuidado para não retirar o prato rotativo da posição correta ao introduzir ou retirar outros acessórios.

**MICRO-ONDAS**

Para cozinhar rapidamente e aquecer alimentos ou bebidas.

POWER	RECOMENDADA PARA
<b>1000W</b>	Aquecimento rápido de bebidas ou outros alimentos com elevado teor de água
<b>800W</b>	Cozinhar legumes
<b>650 W</b>	Cozinhar carne e peixe
<b>500 W</b>	Cozinhar molhos para carne ou molhos que contenham queijo ou ovos. Terminar empadas ou gratinados de massa
<b>350 W</b>	Cozedura lenta. Perfeito para derreter manteiga ou chocolate
<b>160 W</b>	Descongelar alimentos congelados ou amolecer manteiga e queijo
<b>90 W</b>	Amolecer gelados

Acessório recomendado: **tampa**

**CRISP DYNAMIC**

Para dar um tom dourado perfeito a um prato, tanto na parte superior como na parte inferior dos alimentos. Esta função só pode ser utilizada com o prato especial Crisp.

Acessórios necessários: Prato Crisp, manípulo para o prato Crisp

**GRELHADOR**

Para dourar, grelhar e gratinar.

Recomendamos que vire os alimentos durante a cozedura.

Para obter os melhores resultados, pré-aqueça o grelhador durante 3-5 minutos.

Acessório recomendado: **grelha**

**GRELHADOR + MICRO-ONDAS**

Para cozinhar rapidamente e para gratinar pratos, combinando as funções de micro-ondas e de grelhador.

Acessório recomendado: **grelha**

**AUTO FUNÇÕES AUTOMÁTICAS**

Com as funções automáticas, basta selecionar o tipo e o peso ou a quantidade de alimentos para obter os melhores resultados possíveis. O forno irá calcular automaticamente as definições ideais e continuar a alterá-las à medida que a cozedura progride.



DEFROST

AUTO

**DEFROST DYNAMIC**

Para descongelar rapidamente alimentos com um peso entre 100 g e 3 kg. Os alimentos devem ser colocados diretamente no prato rotativo de vidro. Vire os alimentos quando lhe for solicitado.

CATEGORIA	RECOMENDADA PARA ALIMENTOS	PESO
1*	CARNE (carne picada, costeletas, bifes, peças de carne recheadas)	100 g - 2 kg
2*	AVES (frango inteiro, em pedaços ou em filetes)	100 g - 2,5 kg
3*	PEIXE (postas inteiras ou filetes)	100 g - 1,5 kg
4*	LEGUMES (legumes variados, ervilhas, brócolos, etc.)	100 g - 1,5 kg
5*	PÃO (pães, bolos)	100 g - 1 kg



REHEAT

AUTO





**REHEAT DYNAMIC**

Para aquecer refeições prontas congeladas ou à temperatura ambiente. O forno calcula automaticamente os valores necessários para obter os melhores resultados no menor tempo possível. Coloque os alimentos numa travessa ou num prato resistente ao calor adequado para fornos micro-ondas.

CATEGORIA	ALIMENTO	PESO
1	PRÉ-COZINHADOS	250 - 500g
2*	PORÇÃO CONGELADA	250 - 500 g
3*	LASANHA CONGELADA	250 - 500 g
4	SOPAS	200 - 800 g
5	BEBIDAS	1 - 5 dl

## FUNÇÕES AUTOMÁTICAS

 **CRISP** AUTO **CRISP DYNAMIC**  
Para aquecer rapidamente e cozinhar alimentos congelados, obtendo um tom dourado e uma cobertura estaladiça. Utilize apenas esta função com o prato Crisp fornecido. Vire os alimentos quando lhe for solicitado.





CATEGORIA	ALIMENTO	PESO
 1*	BATATAS FRITAS (disponha as batatas numa única camada e salpique-as com sal antes de iniciar a cozedura)	200 - 500 g
 2*	PIZZA, MASSA FINA	200 - 600 g
 3*	PIZZA, MASSA NORMAL	300 - 800 g
 4*	ASAS DE FRANGO, PEDAÇOS DE FRANGO (Unte ligeiramente o tabuleiro com óleo ou azeite)	200 - 500 g
 5*	DOURADINHOS DE PEIXE (O prato Crisp deverá ser pré-aquecido)	100 - 500 g

Acessórios necessários: Prato Crisp, manípulo para o prato Crisp



## **COOK** AUTO **COOK DYNAMIC**

Para alimentos cozinhados no forno rapidamente e atingir ótimos resultados. Utilize um tabuleiro adequado para fornos e resistente às micro-ondas.

CATEGORIA	ALIMENTO	PESO
 1	BATATAS ASSADAS (Vire quando tal lhe for solicitado pelo forno)	200g - 1kg
 2	LEGUMES FRESCOS (Corte uniformemente e adicione 2 a 4 colheres de sopa de água. Tape.)	200 - 800 g
 3*	LEGUMES CONGELADOS (Vire quando tal lhe for solicitado pelo forno. Tape)	200 - 800 g
 4	LEGUMES ENLATADOS	200 - 600 g
 5	PIPOCAS	100 g



## **DEFIN** **DEFINIÇÕES**

Para alterar as definições do forno (idioma, relógio, volume de sinais sonoros, luminosidade, modo ecológico).

Lembre-se: Quando o modo ecológico está ativo, a luminosidade do visor é reduzida após alguns segundos para poupar energia. É reativado automaticamente quando algum dos botões é premido, etc.

# PRIMEIRA UTILIZAÇÃO DO APARELHO

## 1. SELECIONAR O IDIOMA

Ao ligar o aparelho pela primeira vez, terá de definir o idioma e a hora: a palavra "ENGLISH" será apresentada no visor: Rode o *botão de ajuste* para percorrer a lista de idiomas disponíveis e selecionar aquele que pretende.





Prima  para confirmar a seleção.

Lembre-se: O idioma pode ser alterado posteriormente na opção "Definições" do menu.

## 2. ACERTAR A HORA

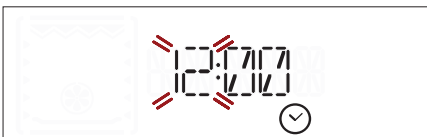
Após selecionar o idioma, terá de acertar a hora atual: No visor piscam os dois dígitos relativos à hora.



Rode o *botão de ajuste* para definir a hora correta e prima : A hora irá começar a piscar no visor.

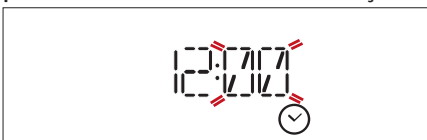

Rode o *botão de ajuste* para definir os minutos corretos e prima  para confirmar.

Lembre-se: Poderá ter de acertar novamente a hora após um longo corte de energia.

Quando ativar o forno pela primeira vez ou no seguimento de um corte de energia prolongado, certifique-se de que a porta do forno está fechada e, em seguida, defina a hora e o idioma.

# UTILIZAÇÃO DIÁRIA

## 1. SELECIONAR UMA FUNÇÃO

Rode o *botão seletor* até que a função que pretende selecionar apareça no visor: o visor irá apresentar o ícone correspondente à função e às suas definições básicas.



Para selecionar um item do menu (o visor irá apresentar o primeiro item disponível), rode o *botão de ajuste* até que o item que pretende selecionar seja apresentado.





Prima  para confirmar a sua seleção: o visor irá apresentar as definições básicas.

## 2. DEFINIR UMA FUNÇÃO

Após selecionar uma função, é possível alterar as suas definições.

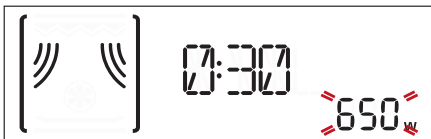
O visor irá apresentar as definições que podem ser alteradas em sequência.



Quando o valor começar a piscar no visor, rode o *botão de ajuste* para alterar o item selecionado e, em seguida, prima  para confirmar e passar às definições seguintes.

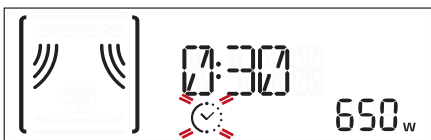

Lembre-se: premindo  permite-lhe alterar o valor anterior novamente.

## 3. ATIVAR UMA FUNÇÃO

Após aplicar todas as definições pretendidas, prima  para ativar a função.



Poderá premir  em qualquer altura para interromper a função que estiver ativada nessa altura.

## . BLOQUEIO DE SEGURANÇA

Esta função é ativada automaticamente para evitar que o forno seja ligado inadvertidamente.

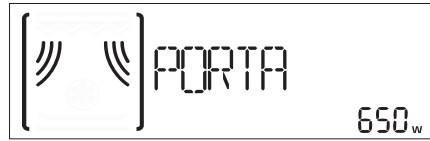

Abra e feche a porta e, em seguida, prima  para iniciar a função.

## . PAUSA

Para colocar em pausa uma função ativa, por exemplo, para poder mexer os alimentos ou virá-los, basta abrir a porta.

Para concluir o processo de cozedura, feche a porta e prima .

## . JET START

Com o forno desligado, prima  para ativar a cozedura com a função de micro-ondas na potência máxima (1000 W) durante 30 segundos.

Sempre que premir novamente o botão , o tempo de cozedura aumenta mais 30 segundos.

## FUNÇÕES AUTOMÁTICAS

### CATEGORIAS

Deve selecionar a categoria dos alimentos ao utilizar determinadas funções automáticas.

A categoria de referência corresponde ao número indicado no canto superior direito do visor.



Consulte a tabela contendo as descrições das funções para mais informações sobre todas as categorias.

### GRAU DE PREPARAÇÃO

É necessário selecionar o grau de preparação dos alimentos para a maior parte das funções automáticas. Após ativar esta função, o grau de preparação só pode ser alterado durante os primeiros 20 segundos de operação: ative a função e, em seguida, rode o *botão de ajuste* para selecionar a definição pretendida.



## AÇÕES (MEXER OU VIRAR OS ALIMENTOS)

Algumas funções automáticas incluem pausas para permitir que o utilizador vire ou mexa os alimentos.



Interrompida a cozedura, abra a porta do forno e realize as ações que lhe forem solicitadas antes de fechar a porta novamente e premir ► para prosseguir com a cozedura.

Lembre-se: Se estiver a utilizar a função "Dynamic defrost", esta irá reiniciar automaticamente após dois minutos, mesmo que não tenha mexido ou virado os alimentos.

## . TEMPORIZADOR

Quando o forno é desligado, o visor pode ser utilizado como um temporizador. Para ativar a função e definir a duração pretendida, rode o *botão de ajuste*.



Prima **OK select** para desativar o temporizador: Quando o temporizador terminar a contagem decrescente do tempo programado, ouvir-se-á um sinal sonoro e esta informação será apresentada no visor.

Lembre-se: O temporizador não ativa nenhum dos ciclos de cozedura.













































Para alterar o temporizador, rode o *botão de ajuste*. Para parar o temporizador e regressar à hora atual no visor, prima <<.

Uma vez ativado o temporizador, poderá ativar a função também: O temporizador irá continuar a realizar automaticamente uma contagem decrescente do tempo selecionado sem que isso tenha quaisquer implicações para a função.



Para regressar ao temporizador, aguarde até que a função esteja concluída ou desligue o forno, premindo ①.







# TABELA DE COZEDURA

ALIMENTO	FUNÇÃO	POWER (W)	TEMPO (MIN.)	ACESSÓRIOS
Pão de ló		-	7 - 15	
Tarte de frutas		-	12 - 20	
Biscoitos		-	4 - 6	
Tartes salgadas ou Quiche Lorraine (1 - 1,2 kg)		-	18 - 25	
Refeições prontas (250 - 500 g)		800	4 - 7	-
Lasanha/massa gratinada		350 - 500	15 - 25	 
Lasanha congelada (500 - 700 g)		500 - 800	14 - 20	-
Pizza (400 - 500 g)		-	10 - 12	
Carne (costeletas, bifes)		500	10 - 15	 
Aves (por inteiro, 800 g - 1,5 kg)		350 - 500	30 - 45 *	 
Pedaços ou filetes de frango		350 - 500	10 - 17	 
Assados (800 g - 1.2 kg)		350 - 500	25 - 40 *	 
Salsichas/espetadas		-	20 - 40 *	
salsichas/hambúrgueres		-	6 - 16 *	 **
Peixe (postas ou filetes)		160 - 350	15 - 20 *	 
Peixe inteiro (800 g - 1,2 kg)		160 - 350	20-30 *	 
Batatas assadas (600 g - 1 kg)		350 - 500	30 - 50 *	 
Gomos de batata (500 g - 800 g)		-	20-30	
Maçãs assadas		160 - 350	15 - 25	 

\* Vire o alimento a meio da cozedura

\*\* Pré-aqueça o prato Crisp durante 3-5 minutos

 [www](http://www.hotpoint.eu) Transfira o Guia de Utilização e Manutenção em [www.hotpoint.eu](http://www.hotpoint.eu) para consultar a tabela de receitas testadas, compiladas para as autoridades de certificação de acordo com a norma IEC 60350

FUNÇÕES	Crisp 	Grelhador 	Grelhador + Micro-ondas 
ACESSÓRIOS	Prato resistente ao calor/recipiente adequado para utilização no micro-ondas 	Grelha 	Prato Crisp 

# LIMPEZA

**Assegure-se de que o forno arrefece antes de executar qualquer operação de manutenção ou limpeza.**

**Não utilize aparelhos de limpeza a vapor.**

**Não utilize palha de aço, esfregões abrasivos ou produtos de limpeza abrasivos/corrosivos, uma vez que estes podem danificar as superfícies do aparelho.**

## SUPERFÍCIES EXTERIORES

- Limpe as superfícies com um pano húmido. Se estiverem muito sujas, acrescente alguns pingos de detergente com PH neutro. Termine a limpeza com um pano seco.
- Limpe o vidro da porta com um detergente líquido adequado.
- Periodicamente, ou quando houver derrames, retire o prato rotativo e o respetivo suporte para limpar o fundo do forno, retirando todos os restos de alimentos.
- O grelhador não precisa de ser limpo, uma vez que o calor intenso queima qualquer sujidade: Utilize esta função regularmente.

## ACESSÓRIOS

Todos os acessórios podem ser lavados na máquina de lavar louça, exceto o prato Crisp. O prato Crisp deve ser lavado com água e um detergente suave. Para sujidade difícil, esfregue suavemente com um pano. Deixe sempre que o prato Crisp arrefeça antes de o limpar.

# RESOLUÇÃO DE PROBLEMAS

Problema	Causa possível	Solução
O forno não funciona	Corte de energia Desligado da rede elétrica	Verifique se há energia elétrica proveniente da rede e se o forno está ligado à tomada elétrica Desligue e volte a ligar o forno, para verificar se o problema ficou resolvido.
O forno emite ruídos, mesmo quando está desligado	Ventilador de refrigeração ativado	Abra a porta ou aguarde que o processo de arrefecimento esteja concluído.
O visor apresenta a mensagem "Err"	Erro de software	Contacte o Serviço Pós-Venda mais próximo e indique a letra ou o número que acompanha a mensagem "Err".

## FICHA DE PRODUTO

 [www](http://www.hotpoint.eu) A ficha do produto contendo os dados energéticos para este aparelho, pode ser transferida a partir do website [www.hotpoint.eu](http://www.hotpoint.eu)

## COMO OBTER O GUIA DE UTILIZAÇÃO E MANUTENÇÃO

 [www](http://www.hotpoint.eu) Transfira o Guia de Utilização e Manutenção a partir do nosso website <http://www.hotpoint.eu> (pode utilizar este código QR), especificando o código comercial do produto.

Em alternativa, contacte o nosso Serviço Pós-Venda



## CONTACTAR O NOSSO SERVIÇO PÓS-VENTA

Pode encontrar os nossos contactos no manual de garantia. Ao contactar o nosso Serviço Pós-Venda, indique os códigos fornecidos na placa de identificação do seu produto.

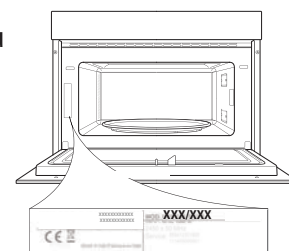



# GUÍA DE CONSULTA DIARIA



## GRACIAS POR HABER ADQUIRIDO UN PRODUCTO HOTPOINT-ARISTON

Si desea recibir asistencia y soporte adicionales, registre su producto en [www.hotpoint.eu/register](http://www.hotpoint.eu/register)



Puede descargarse las instrucciones de seguridad y la «Guía de uso y cuidado» en la página web [www.hotpoint.eu](http://www.hotpoint.eu) siguiendo las instrucciones que figuran al dorso de este documento.



**Antes de usar el producto, lea atentamente las instrucciones de seguridad**

## DESCRIPCIÓN DEL PRODUCTO

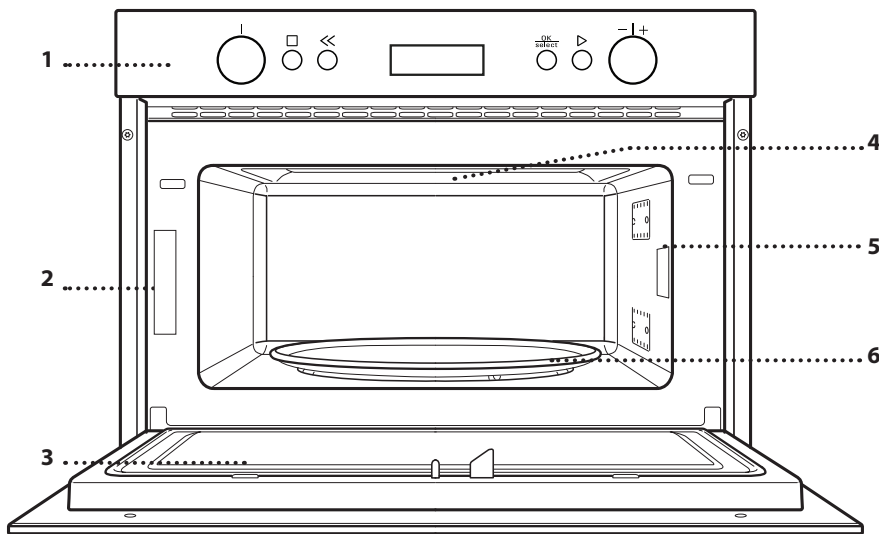

1. Panel de control
2. Placa de características (no quitar)
3. Puerta
4. Resistencia superior/grill
5. Luz
6. Plato giratorio

## PANEL DE CONTROL

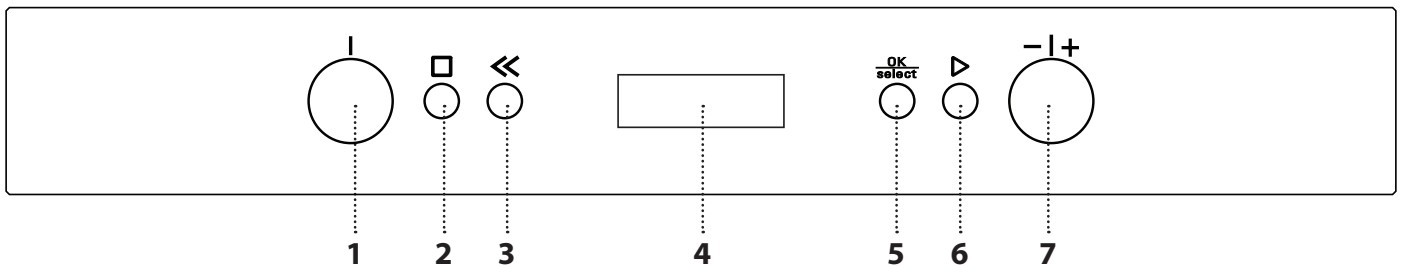

### 1. SELECTOR

Para encender el horno seleccionando una función. Póngalo en la posición "0" para apagar el horno.

### 2. STOP

Para detener la función actualmente activa en cualquier momento y poner el horno en el modo de espera.

### 3. ATRÁS

Sirve para volver al menú anterior.

### 4. PANTALLA

### 5. BOTÓN DE CONFIRMACIÓN

Sirve para confirmar una función o un valor seleccionados.

### 6. BOTÓN DE CONFIRMACIÓN

Para iniciar inmediatamente una función. Cuando el horno está apagado, activa la función de inicio rápido del microondas "Jet Start".

### 7. SELECTOR DE AJUSTE

Para desplazarse por los menús y aplicar o cambiar las configuraciones.

Nota: Todos los selectores se quedan pulsados al activarlos. Pulse en el centro del selector para liberarlo de la configuración.

## PLATO GIRATORIO

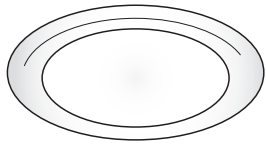

El plato giratorio debe estar colocado en su soporte y puede utilizarse en todos los métodos de cocción.

El plato giratorio siempre debe utilizarse como base para otros contenedores o accesorios, excepto con el plato para hornear rectangular.

## SOPORTE DEL PLATO GIRATORIO

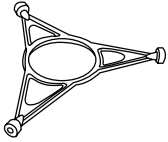

Utilice el soporte solamente para el plato giratorio de cristal. No coloque otros accesorios en el soporte.

## BANDEJA CRISP

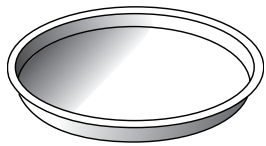

Utilizar solo con la función indicada.

La bandeja Crisp se tiene que colocar siempre en el centro del plato giratorio de cristal y se puede precalentar cuando está vacía, usando la función especial correspondiente. Coloque la comida directamente en la bandeja Crisp.

## ASA DE LA BANDEJA CRISP

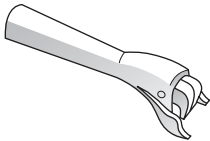

Útil para retirar la bandeja Crisp caliente del horno.

## PARRILLA

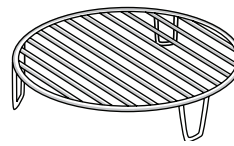

Con ella podrá colocar los alimentos más cerca del grill para obtener un dorado perfecto. Coloque la parrilla en el plato giratorio, asegurándose de que no entre en contacto con otras superficies.

## TAPA

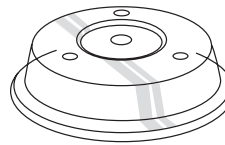

Útil para tapan los recipientes durante el calentamiento y la cocción en el microondas. La tapa reduce las salpicaduras, mantiene la humedad de los alimentos y también se puede

utilizar para crear dos niveles de cocción. No es compatible con ninguna de las funciones de grill (incluida la «Crisp Dynamic»).

El número de accesorios puede variar de un modelo a otro.

Se pueden adquirir otros accesorios por separado en el Servicio Postventa.

**Hay varios accesorios disponibles en el mercado. Antes de adquirirlos, asegúrese de que son aptos para el microondas y resistentes a las temperaturas del horno.**

**Los contenedores metálicos para alimentos o bebidas no deben utilizarse nunca para la cocción con el microondas.**

**Asegúrese siempre de que ni los alimentos ni los accesorios entren en contacto con las paredes internas del horno.**

**Compruebe siempre que el plato giratorio gira sin problemas antes de poner en marcha el horno. Tenga cuidado de no desencajar el plato giratorio cuando introduzca o saque otros accesorios.**

# FUNCIONES



Para más información, descargue la Guía de uso y cuidado de [www.hotpoint.eu](http://www.hotpoint.eu)



## MICROONDAS

Para cocinar y recalentar alimentos o bebidas con rapidez.

POWER	RECOMENDADA PARA
<b>1000W</b>	Calentar rápidamente bebidas u otros alimentos con alto contenido en agua
<b>800W</b>	Cocción de verduras
<b>650 W</b>	Cocción de carne y pescado
<b>500 W</b>	Cocción de salsas con carne, o salsas que contengan queso o huevo. Acabado de pasteles de carne o pasta al horno
<b>350 W</b>	Cocción lenta y suave. Perfecta para derretir mantequilla o chocolate
<b>160 W</b>	Descongelar alimentos o ablandar mantequilla o queso
<b>90 W</b>	Ablandar helados

Accesorio recomendado: **tapa**



## CRISP DYNAMIC

Para dorar perfectamente un alimento, tanto por arriba como por abajo. Esta función se debe utilizar solamente con la bandeja Crisp especial.

Accesorios necesarios: **Bandeja Crisp, asa de la bandeja Crisp**



## GRILL

Para dorar y gratinar. Es recomendable girar los alimentos durante la cocción. Para obtener los mejores resultados, precaliente el grill durante 3-5 minutos.

Accesorio recomendado: **parrilla**



## GRILL + MICROONDAS

Para cocinar y gratinar rápidamente, combinando las funciones de microondas y las de grill.

Accesorio recomendado: **parrilla**

## AUTO FUNCIONES AUTOMÁTICAS

Con las funciones automáticas, simplemente seleccione el tipo y el peso o la cantidad de alimentos para obtener los mejores resultados. El horno calculará automáticamente la configuración óptima y seguirá cambiándola a lo largo del proceso de cocción.



## DEFROST DYNAMIC

Para descongelar alimentos de entre 100 g y 3 kg de forma rápida. Los alimentos deben colocarse directamente en el plato giratorio. Remueva los alimentos cuando lo indique.

CATEGORÍA	ALIMENTOS RECOMENDADOS	PESO
1*	CARNE (carne picada, chuletas, filetes, asados)	100 g-2 kg
2*	AVES (pollo entero, en trozos o filetes)	100 g-2,5 kg
3*	PESCADO (lomos enteros o en filetes)	100 g-1,5 kg
4*	VERDURAS (verduras variadas, guisantes, brócoli, etc.)	100 g-1,5 kg
5*	PAN (panes, bollos)	100 g-1 kg



## REHEAT DYNAMIC

Sirve para calentar alimentos precocinados que estén congelados o a temperatura ambiente.

El horno calcula automáticamente la configuración requerida para obtener los mejores resultados en el menor tiempo posible. Coloque los alimentos en una bandeja o plato aptos para microondas.

CATEGORÍA	ALIMENTO	PESO
1	PRE-COCINADOS	250-500 g
2*	PORCIÓN CONGELADA	250-500 g
3*	LASAÑA CONGELADA	250-500 g
4	SOPAS	200-800 g
5	BEBIDAS	1-5 dl





## FUNCIONES AUTOMÁTICAS

 **CRISP** AUTO **CRISP DYNAMIC**  
Para calentar y cocinar rápidamente alimentos congelados y darles un gratinado crujiente. Utilice esta función solamente con la bandeja Crisp. Remueva los alimentos cuando lo indique.

CATEGORÍA	ALIMENTO	PESO
 1*	PATATAS FRITAS (extiéndalas en una sola capa y añada sal antes de freírlas)	200-500 g
 2*	PIZZA, MASA FINA	200-600 g
 3*	PIZZA, MASA GRUESA	300-800 g
 4*	ALAS DE POLLO, TROZOS DE POLLO (Ponga un poco de aceite en la bandeja)	200-500 g
 5*	PALITOS DE PESCADO (La bandeja Crisp se tiene que precalentar)	100-500 g

Accesorios necesarios: Bandeja Crisp, asa de la bandeja Crisp

 **COOK** AUTO **COOK DYNAMIC**  
Para cocer rápidamente alimentos al horno y conseguir unos resultados óptimos. Utilice recipientes de cocción aptos para el horno y resistentes a las microondas.

CATEGORÍA	ALIMENTO	PESO
 1	PATATAS ASADAS (Gire cuando se indique)	200g - 1kg
 2	VERDURAS FRESCAS (Corte de forma uniforme y añada de 2 a 4 cucharadas soperas de agua. Tape)	200-800 g
 3*	VERDURAS CONGELADAS (Gire cuando se indique. Tape)	200-800 g
 4	VERDURAS EN LATA	200-600 g
 5	PALOMITAS	100 g

 **CONFIGURACIÓN**  
Para cambiar la configuración del horno (idioma, reloj, volumen de la señal acústica, brillo, modo Eco).

Nota: Cuando el modo Eco está activado, al cabo de unos segundos se reduce el brillo de la pantalla para ahorrar energía. Se vuelve a activar automáticamente al pulsar cualquier botón.

## PRIMER USO

### 1. SELECCIONE EL IDIOMA

La primera vez que encienda el aparato, tendrá que seleccionar el idioma y ajustar la hora: la palabra «ENGLISH» aparece en la pantalla: Gire el *selector de ajuste* para desplazarse por la lista de idiomas disponibles y seleccionar el que desee.





Pulse  para confirmar la selección.

Nota: Puede cambiar el idioma más tarde desde el menú de «Configuración».

### 2. CÓMO CONFIGURAR LA HORA

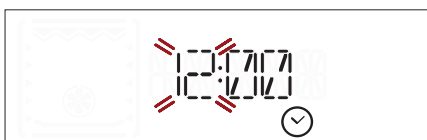
Después de seleccionar el idioma, tendrá que configurar la hora actual: En la pantalla parpadean las dos cifras de la hora.



Gire el *selector de ajuste* para establecer la hora correcta y pulse : Los minutos parpadearán en la pantalla.

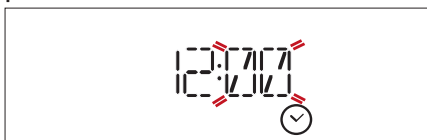

Gire el *selector de ajuste* para establecer los minutos y pulse  para confirmar.

Nota: Después de un corte de suministro prolongado, es posible que tenga que volver configurar la hora. Al utilizar el aparato por primera vez o tras un corte prolongado del suministro eléctrico, asegúrese de que la puerta del horno esté cerrada antes de configurar el idioma y la hora.

# USO DIARIO

## 1. SELECCIONAR UNA FUNCIÓN

Gire el *selector* hasta que la función deseada aparezca en la pantalla: En la pantalla aparecerá el icono y la configuración básica de la función.



Para seleccionar un elemento del menú (la pantalla mostrará el primer elemento disponible), gire el *selector de ajuste* hasta que se visualice el elemento que desea.



Pulse **OK** para confirmar la selección: En la pantalla aparecerá la configuración básica.

## 2. AJUSTAR LA FUNCIÓN

Cuando haya seleccionado la función que desee, puede cambiar la configuración correspondiente. En la pantalla aparecerá la configuración que se puede cambiar por orden.

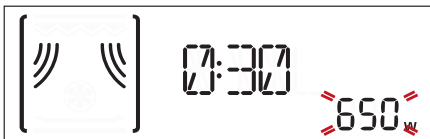

Cuando el valor parpadee en la pantalla, gire el *selector* para cambiar el elemento seleccionado, pulse **OK** para confirmar y siga con la configuración.



Nota: pulsar **◀** permite al usuario modificar el valor anterior de nuevo.

## 3. ACTIVAR LA FUNCIÓN

Una vez que haya aplicado la configuración deseada, pulse **▶** para activar la función.



Puede pulsar **□** en cualquier momento para poner en pausa la función que esté activada en ese momento.

## . BLOQUEO DE SEGURIDAD

Esta función se activa automáticamente para evitar la activación accidental del horno.

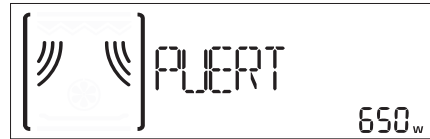

Abra y cierre la puerta, y pulse **▶** para activar la función.

## . PAUSA

Para detener una función activa, por ejemplo para mover o girar la comida, solamente tendrá que abrir la puerta.

Para reanudar el proceso de cocción, cierre la puerta y pulse **▶**.

## . JET START

Cuando el horno esté apagado, pulse **▶** para activar la cocción con la función microondas a la potencia máxima (1000 W) durante 30 segundos.

Cada vez que pulse el botón **▶**, el tiempo de cocción se incrementará en otros 30 segundos.

## FUNCIONES AUTOMÁTICAS

### CATEGORÍAS

Para utilizar algunas funciones automáticas se debe seleccionar la categoría de alimentos adecuada. La categoría de referencia corresponde al número indicado en la parte superior derecha de la pantalla.



Consulte la tabla de las descripciones de las funciones para obtener más información sobre todas las categorías.

### GRADO DE COCCIÓN

La mayoría de las funciones le pedirán que seleccione el punto de cocción de los alimentos.

El grado de cocción se puede modificar durante los primeros 20 segundos de funcionamiento una vez activada la función: Active la función, luego gire el *selector de ajuste* para seleccionar la configuración necesaria.



## ACCIONES (REMOVER O GIRAR ALIMENTOS)

Algunas funciones automáticas incluyen pausas para que el usuario pueda remover o girar los alimentos.



Cuando el horno se haya detenido, abra la puerta y lleve a cabo la acción que se le solicite antes de volver a cerrar la puerta y pulsar **▶** para continuar la cocción.

Nota: Cuando utilice la función «Defrost dynamic», la función se reiniciará automáticamente al cabo de dos minutos, aunque no haya girado o removido el alimento.

## . TIMER

Cuando el horno está apagado, la pantalla puede utilizarse como temporizador. Para activar la función y establecer el tiempo necesario, gire el *selector de ajuste*.



Pulse **OK select** para activar el temporizador: Una vez que haya finalizado la cuenta atrás del tiempo seleccionado sonará una señal acústica y la pantalla lo indicará.

Nota: El temporizador no activa ninguno de los ciclos de cocción.





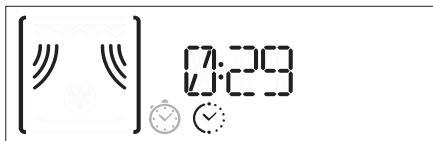







































Gire el *selector de ajuste* para cambiar el temporizador. Pulse **<<** para detener el temporizador y volver a la pantalla de hora actual.

Cuando se haya activado el temporizador, también podrá activar una función: El temporizador proseguirá la cuenta atrás automáticamente sin que ello tenga ningún efecto sobre la función.



Para volver al temporizador, espere a que la función finalice o apague el horno pulsando **⓪**.







# TABLA DE COCCIÓN

ALIMENTO	FUNCIÓN	POWER (W)	TIEMPO (MIN)	ACCESORIOS
Bizcocho		-	7 - 15	
Tarta de frutas		-	12 - 20	
Galletas		-	4 - 6	
Tartas saladas o quiches Lorraine (1-1,2 kg)		-	18 - 25	
Comida preparada (250-500 g)		800	4 - 7	-
Lasaña/pasta al horno		350 - 500	15 - 25	 
Lasaña congelada(500-700 g)		500 - 800	14 - 20	-
Pizza (400-500 g)		-	10 - 12	
Carne (chuletas, filetes)		500	10 - 15	 
Aves(enteras, 800 g-1,5 kg)		350 - 500	30 - 45 *	 
Filetes o trozos de pollo		350 - 500	10 -17	 
Asados (800 g-1,2 kg)		350 - 500	25 - 40 *	 
Salchichas/brochetas		-	20 - 40 *	
Salchichas/hamburguesas		-	6 - 16 *	 **
Pescado (filetes o rodajas)		160 - 350	15 - 20 *	 
Pescado entero(800 g-1,2 kg)		160 - 350	20-30 *	 
Patatas asadas(600 g-1 kg)		350 - 500	30 - 50 *	 
Patas en cuña(500 g-800 g)		-	20-30	
Manzanas asadas		160 -350	15 -25	 

\* Dar la vuelta al alimento a mitad de la cocción

\*\* Precaliente la bandeja Crisp durante 3-5 minutos

 Descargue la «Guía de uso y cuidado» en [www.hotpoint.eu](http://www.hotpoint.eu), donde encontrará la tabla de las recetas probadas recogida por los órganos de certificación de conformidad con la norma IEC 60350

FUNCIONES	Crisp 	Grill 	Grill + Microondas 
ACCESORIOS	Plato resistente al calor/contenedor apto para el microondas 	Rejilla 	Bandeja crisp 

# LIMPIEZA

**Asegúrese de que el horno se haya enfriado antes de llevar a cabo las tareas de mantenimiento o limpieza.**

**No utilice aparatos de limpieza con vapor.**

**No utilice estropajos de acero, estropajos abrasivos ni productos de limpieza abrasivos/corrosivos, ya que podrían dañar las superficies del aparato.**

## SUPERFICIES EXTERIORES

- Limpie las superficies con un paño húmedo. Si están muy sucias, añada unas gotas de detergente neutro al agua. Seque con un paño seco.
- Limpie el cristal de la puerta con un detergente líquido adecuado.
- A intervalos regulares o si se derrama algo, retire el plato giratorio y el soporte para limpiar el fondo del horno, retirando todos los restos de alimentos.
- No es necesario limpiar la resistencia del grill puesto que el calor intenso quemará toda la suciedad: Utilice esta función con regularidad.

## ACCESORIOS

Todos los accesorios son aptos para el lavavajillas a excepción de la bandeja Crisp. La bandeja Crisp se tiene que limpiar con agua y un detergente suave. Para la suciedad más resistente, frote suavemente con un paño. Espere siempre a que la bandeja Crisp se enfríe antes de limpiar nada.

# RESOLUCIÓN DE PROBLEMAS

Problema	Posible causa	Solución
El horno no funciona	Corte de suministro Desconexión de la red eléctrica	Compruebe que haya corriente eléctrica en la red y que el horno esté enchufado Apague el horno y vuelva a encenderlo para comprobar si se ha solucionado el problema.
El horno hace ruidos incluso estando apagado	Ventilador de enfriamiento activo	Abra la puerta o espere a que finalice el proceso de enfriamiento.
La pantalla muestra «Err»	Error de software	Póngase en contacto con el Servicio Postventa más cercano e indique la letra o número que aparecen detrás de «Err».

## TARJETA DE DATOS DEL PRODUCTO

 [www](http://www.hotpoint.eu) La ficha del producto con los datos de energía de este aparato se puede descargar en el sitio web [www.hotpoint.eu](http://www.hotpoint.eu)

## CÓMO OBTENER LA GUÍA DE USO Y CUIDADO

>  Descargue la «Guía de uso y cuidado» en nuestra página web <http://www.hotpoint.eu> (puede utilizar este código QR), especificando el código del producto.

> También puede ponerse en contacto con nuestro Servicio Postventa



## CÓMO PONERSE EN CONTACTO CON NUESTRO SERVICIO POSTVENTA

Encontrará nuestros datos de contacto en el manual de garantía. Cuando se ponga en contacto con nuestro Servicio Postventa, deberá indicar los códigos que figuran en la placa de características de su producto.

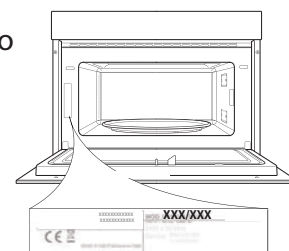

PREDECESSOR 400010856692



# OWNER'S MANUAL



## THANK YOU FOR PURCHASING A HOTPOINT - ARISTON PRODUCT

To receive more comprehensive help and support, please register your product at [www.hotpoint.eu/register](http://www.hotpoint.eu/register)



Download the safety instructions and the Use and Care Guide by visiting the website

[www.hotpoint.eu](http://www.hotpoint.eu), and follow the procedure indicated on the back.



**Read the safety instructions carefully before using the product**

## PRODUCT DESCRIPTION

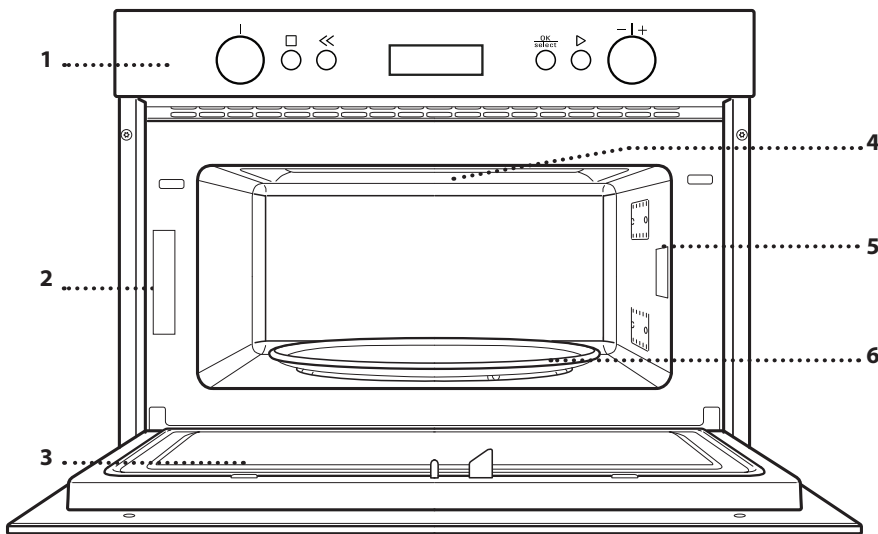

1. Control panel
2. Identification plate (do not remove)
3. Door
4. Upper heating element/grill
5. Light
6. Turntable

## CONTROL PANEL

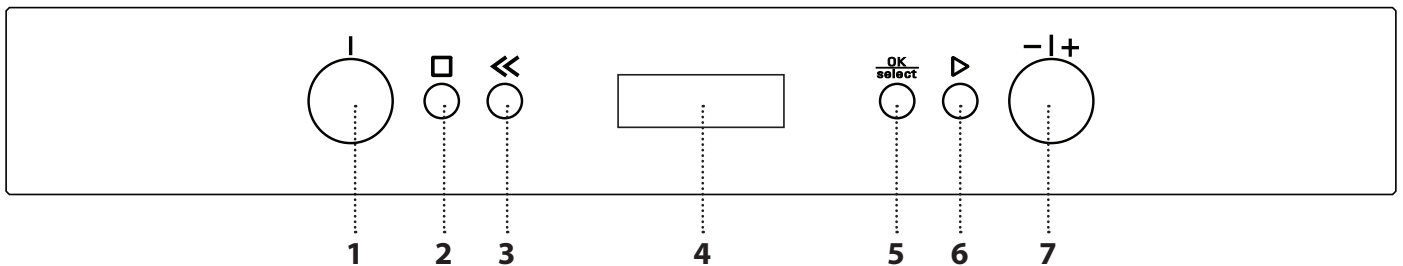

### 1. SELECTION KNOB

For switching the oven on by selecting a function. Turn to the "0" position to switch the oven off.

### 2. STOP

For stopping the function that is currently active at any time and putting the oven into standby mode.

### 3. BACK

For returning to the previous menu.

### 4. DISPLAY

**5. CONFIRMATION BUTTON**  
For confirming a selected function or a set value.

### 6. CONFIRMATION BUTTON

For immediately starting a function. When the oven is switched off, it activates the "Jet Start" microwave function.

### 7. ADJUSTMENT KNOB

For scrolling through the menus and applying or changing settings.

Please note: All knobs are push-activated knobs. Push down on the centre of the knob to release it from its seating.

## TURNTABLE

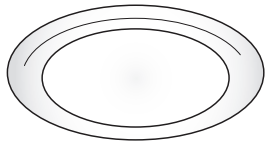

Placed on its support, the glass turntable can be used with all cooking methods.

The turntable must always be used as a base for other containers or accessories, with the exception of the rectangular baking plate.

## TURNTABLE SUPPORT

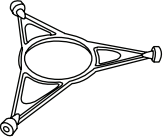

Only use the support for the glass turntable. Do not rest other accessories on the support.

## CRISP PLATE

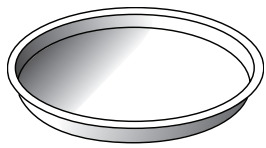

Only for use with the designated function. The crisp plate must always be placed in the centre of the glass turntable and can be

preheated when empty, using the special function for this purpose only. Place the food directly on the crisp plate.

## HANDLE FOR THE CRISP PLATE

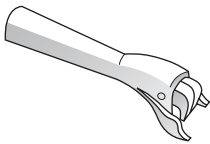

Useful for removing the hot crisp plate from the oven.

## WIRE SHELF

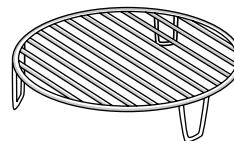

surfaces.

This allows you to place food closer to the grill, for perfectly browning your dish. Place the wire shelf on the turntable, making sure that it does not

## COVER

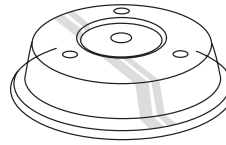

Useful for covering containers during microwave cooking and heating.

The cover reduces splashes, keeps foods moist and can also be used to create two cooking

levels.

Not suitable for use with any of the grill functions (including "Crisp Dynamic").

The number of accessories may vary depending on which model is purchased.

Other accessories can be purchased separately from the After-sales Service.

There are a number of accessories available on the market. Before you buy, ensure they are suitable for microwave use and resistant to oven temperatures.

Metallic containers for food or drink should never be used during microwave cooking.

Always ensure that foods and accessories do not come into contact with the inside walls of the oven.

Always ensure that the turntable is able to turn freely before starting the oven. Take care not to unseat the turntable whilst inserting or removing other accessories.

**MICROWAVES**

For quickly cooking and reheating food or drinks.

POWER	RECOMMENDED FOR
<b>1000W</b>	Quickly reheating drinks or other foods with a high water content
<b>800W</b>	Cooking vegetables
<b>650 W</b>	Cooking meat and fish
<b>500 W</b>	Cooking meaty sauces, or sauces containing cheese or egg. Finishing off meat pies or pasta bakes
<b>350 W</b>	Slow, gently cooking. Perfect for melting butter or chocolate
<b>160 W</b>	Defrosting frozen foods or softening butter and cheese
<b>90 W</b>	Softening ice cream

Recommended accessory: **cover**

**CRISP DYNAMIC**

For perfectly browning a dish, both on the top and bottom of the food. This function must only be used with the special crisp plate.

Required accessories: **Crisp plate, handle for the Crisp plate**

**GRILL**

For browning, grilling and gratins. We recommend turning the food during cooking. For best results, preheat the grill for 3-5 minutes.

Recommended accessory: **wire shelf**

**GRILL + MICROWAVES**

For quickly cooking and gratinating dishes, combining the microwave and grill functions.

Recommended accessory: **wire shelf**

**AUTO AUTOMATIC FUNCTIONS**

With the automatic functions, simply select the type and weight or the quantity of the food items to obtain the best results. The oven will automatically calculate the optimum settings and continue to change them as cooking progresses.





DEFROST

AUTO

**DEFROST DYNAMIC**

For quickly defrosting food items weighing 100 g to 3 kg. Food should be placed directly onto the glass turntable. Turn the food when prompted.

CATEGORY	RECOMMENDED FOODS	WEIGHT
 1*	MEAT (mince, cutlets, steaks, roasting joints)	100 g - 2 kg
 2*	POULTRY (whole chicken, pieces, fillets)	100 g - 2.5 kg
 3*	FISH (whole, steaks, fillets)	100 g - 1.5 kg
 4*	VEGETABLES (mixed vegetables, peas, broccoli, etc.)	100 g - 1.5 kg
 5*	BREAD (loaves, buns, rolls)	100 g - 1 kg







REHEAT

AUTO





**REHEAT DYNAMIC**

For reheating ready-made food that is either frozen or at room temperature. The oven automatically calculates the settings required to achieve the best results in the shortest amount of time. Place food on a microwave-safe and heatproof dinner plate or dish.

CATEGORY	FOOD	WEIGHT
 1	CONVENIENCE	250 - 500g
 2*	FROZEN PORTION	250 - 500 g
 3*	FROZEN LASAGNA	250 - 500 g
 4	SOUPS	200 - 800 g
 5	BEVERAGES	1 - 5 dl





## AUTOMATIC FUNCTIONS

 **CRISP** AUTO **CRISP DYNAMIC**  
For quickly reheating and cooking frozen foods and giving them a golden, crunchy top. Only use this function with the crisp plate provided. Turn the food when prompted.

CATEGORY	FOOD	WEIGHT
 1*	FRENCH FRIES (spread out in a single layer and sprinkle with salt before cooking)	200 - 500 g
 2*	PIZZA, THIN CRUST	200 - 600 g
 3*	PIZZA, THICK CRUST	300 - 800 g
 4*	CHICKEN WINGS, CHICKEN PIECES (Lightly oil the plate)	200 - 500 g
 5*	FISH FINGERS (Crisp plate must be preheated)	100 - 500 g

Required accessories: Crisp plate, handle for the Crisp plate

 **COOK** AUTO **COOK DYNAMIC**  
For oven-cooking foods quickly and achieving optimal results. Use cookware that is suitable for oven cooking and resistant to microwaves.

CATEGORY	FOOD	WEIGHT
 1	BAKED POTATOES (Turn when prompted)	200g - 1kg
 2	FRESH VEGETABLES (Cut uniformly and add 2 to 4 tablespoons of water. Cover)	200 - 800 g
 3*	FROZEN VEGETABLES (Turn when prompted. Cover)	200 - 800 g
 4	CANNED VEGETABLES	200 - 600 g
 5	POPCORN	100 g

 **SETTINGS**  
For changing the oven settings (language, clock, audible signal volume, brightness, Eco mode).

Please note: When Eco mode is active, the brightness of the display will be reduced after a few seconds to save energy. It is reactivated automatically whenever any of the buttons are pressed, etc.

## USING THE APPLIANCE FOR THE FIRST TIME

### 1. SELECT THE LANGUAGE

You will need to set the language and the time when you switch on the appliance for the first time: the word "ENGLISH" will scroll on the display: Turn the *adjustment knob* to scroll through the list of available languages and select the one you require.





Press  to confirm your selection.

Please note: The language can subsequently be changed from the "Settings" menu.

### 2. SET THE TIME

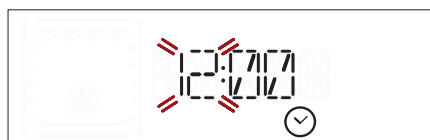
After selecting the language, you will need to set the current time: The two digits for the hour will flash on the display.



Turn the *adjustment knob* to set the correct hour and press : The minutes will flash on the display.



Turn the *adjustment knob* to set the minutes and press  to confirm.

Please note: You may need to set the time again following lengthy power outages. When the oven is activated for the first time, or following a prolonged power outage, check to make sure that the oven's door is closed, and then proceed to set the time and language.

# DAILY USE

## 1. SELECT A FUNCTION

Turn the *selection knob* until the desired function appears on the display: The display will show the icon for the function and its basic settings.

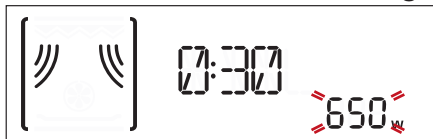

To select an item from the menu (the display will show the first available item), turn the *adjustment knob* until the desired item is displayed.



Press **OK select** to confirm your selection: The display will show the basic settings.

## 2. SET THE FUNCTION

After having selected the function you require, you can change its settings. The display will show the settings that can be changed in sequence.

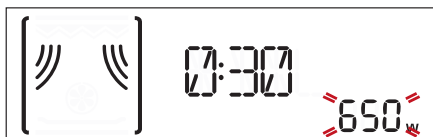

When the value flashes on the display, turn the *adjustment knob* to change the selected item, press **OK select** to confirm, and proceed with the following settings.

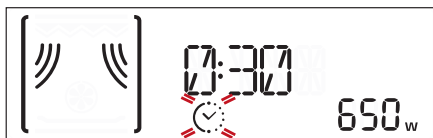

Please note: pressing **←** allows the user to modify the previous value again.

## 3. ACTIVATE THE FUNCTION

Once you have applied the settings you require, press **▶** to activate the function.



You can press **□** at any time to pause the function that is currently active.

## . SAFETY LOCK

This function is automatically activated to prevent the oven from being switched on accidentally.



Open and close the door, then press **▶** to start the function.

## . PAUSE

To pause an active function, for example to stir or turn the food, simply open the door.

To resume the cooking process, close the door and press **▶**.

## . JET START

With the oven off, press **▶** to activate the microwave cooking function at maximum power (1000W) for 30 seconds.

Every time the **▶** button is pressed again, the cooking time will be increased by a further 30 seconds.

## AUTOMATIC FUNCTIONS

### CATEGORIES

The appropriate food category must be selected when using certain automatic functions. The reference category corresponds to the number indicated at the top right of the display.



Refer to the table containing descriptions of the functions for information on all of the categories.

### DEGREE OF DONENESS

Most of the automatic functions will prompt you to select how well done you require the food to be. The degree of doneness can be altered during the first 20 seconds of operation after activating the function: Activate the function, then turn the *adjustment knob* to select the setting you require.



## ACTIONS (STIRRING OR TURNING FOOD)

Certain automatic functions include pauses in order to allow the user to turn or stir the food items.



Once the oven has paused cooking, open the door and carry out the action you are prompted to perform before closing the door again and pressing **▶** to continue with cooking.

Please note: When using the "Dynamic defrost" function, the function will start again automatically after two minutes, even if you have not turned or stirred the food.

## . TIMER

When the oven is switched off, the display can be used as a timer. To activate the function and set the length of time you require, turn the *adjustment knob*.

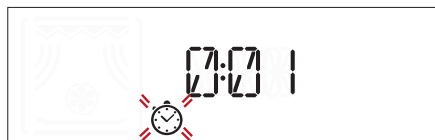

Press **OK select** to activate the timer: An audible signal will sound and the display will indicate once the timer has finished counting down the selected time.

Please note: The timer does not activate any of the cooking cycles.













































To change the timer, turn the *adjustment knob*. To stop the timer and return to the current time display, press **◀**.

Once the timer has been activated, you can activate a function as well: The timer will continue to count down the selected time automatically without having any effect on the function.



To return to the timer, wait for the function to complete or else turn off the oven by pressing **⊖**.

# COOKING TABLE

FOOD	FUNCTION	POWER (W)	TIME (MIN)	ACCESSORIES
Sponge cake		-	7 - 15	
Fruit pie		-	12 - 20	
Cookies		-	4 - 6	
Savoury pies or Quiche Lorraine (1 - 1.2 kg)		-	18 - 25	
Ready-made meals (250 - 500 g)		800	4 - 7	-
Lasagna/pasta bake		350 - 500	15 - 25	 
Frozen lasagna (500 - 700 g)		500 - 800	14 - 20	-
Pizza (400 - 500 g)		-	10 - 12	
Meat (chops, steaks)		500	10 - 15	 
Poultry (whole, 800 g - 1.5 kg)		350 - 500	30 - 45 *	 
Chicken fillets or pieces		350 - 500	10 - 17	 
Roasts (800 g - 1.2 kg)		350 - 500	25 - 40 *	 
Sausages/kebabs		-	20 - 40 *	
Sausages/hamburgers		-	6 - 16 *	 **
Fish (slices or fillets)		160 - 350	15 - 20 *	 
Whole fish (800 g - 1.2 kg)		160 - 350	20 - 30 *	 
Baked potatoes (600 g - 1 kg)		350 - 500	30 - 50 *	 
Potato wedges (500 g - 800 g)		-	20 - 30	
Baked apples		160 - 350	15 - 25	 

\* Turn the food halfway through cooking

\*\* Preheat the crisp plate for 3-5 minutes

 [www](http://www.hotpoint.eu) Download the Use and Care Guide from [www.hotpoint.eu](http://www.hotpoint.eu) to consult the table of tested recipes, which has been compiled for the certification authorities in accordance with the IEC 60350 standard

FUNCTIONS	Crisp 	Grill 	Grill + Microwaves 
-----------	--	--	---

ACCESSORIES	Heatproof plate/container suitable for use in microwaves 	Rack 	Crisp plate 
-------------	---	---	--

# CLEANING

**Make sure that the oven has cooled down before carrying out any maintenance or cleaning.**

**Do not use steam cleaners.**

**Do not use wire wool, abrasive scourers or abrasive/corrosive cleaning agents, as these could damage the surfaces of the appliance.**

## EXTERIOR SURFACES

- Clean the surfaces with a damp cloth. If they are very dirty, add a few drops of pH-neutral detergent. Finish off with a dry cloth.
- Clean the door glass with a suitable liquid detergent.
- At regular intervals or in case of spills, remove the turntable and its support to clean the bottom of the oven, removing all food residue.
- The grill does not need to be cleaned as the intense heat burns away any dirt: Use this function on a regular basis.

## ACCESSORIES

All accessories are dishwasher safe with the exception of the crisp plate. The crisp plate should be cleaned using water and a mild detergent. For stubborn dirt, rub gently with a cloth. Always leave the crisp plate to cool down before cleaning.

# TROUBLESHOOTING

Problem	Possible cause	Solution
The oven does not work	Power cut Disconnection from the mains	Verify that the mains power supply is functioning and that the oven is connected to the electrical outlet Turn off the oven and restart it to see if the fault persists.
The oven makes noise, even when off	Cooling fan active	Open the door or wait until the cooling process has finished.
"Err" is shown on the display	Software error	Contact you nearest After-sales Service Centre and state the letter or number that follows "Err".

## PRODUCT FICHE

 [www](http://www.hotpoint.eu) The product fiche with energy data of this appliance can be downloaded from our website [www.hotpoint.eu](http://www.hotpoint.eu)

## HOW TO OBTAIN THE USE AND CARE GUIDE

- >  [www](http://www.hotpoint.eu) Download the Use and Care Guide from our website <http://www.hotpoint.eu> (you can use this QR code), specifying the product's commercial code.
- > Alternatively, contact our Client After-sales Service



## CONTACTING OUR AFTER-SALES SERVICE

You can find our contact details in the warranty manual. When contacting our Client After-sales Service, please state the codes provided on your product's identification plate.

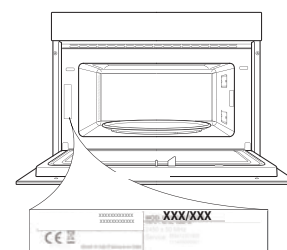

**400011721977**