

**KITCHEN**

CATALOGO LISTINO 2023

**EVERY**

**DAY**

choices  
make  
your

**LIFE**





# KITCHEN

---

CATALOGO LISTINO 2023

30<sup>TH</sup>  
ANNIVERSARY

UNA STORIA DA RACCONTARE, UN'ESPERIENZA DA CONDIVIDERE.  
A STORY TO TELL, AN EXPERIENCE TO SHARE.



MADE IN ITALY

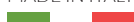

**FOCUSED  
ON LIFE**  
MAKING  
IT EASIER



# INDEX

Una gamma di prodotti completa e coordinabile; design, funzionalità e praticità al servizio delle esigenze quotidiane.

Con passione e dedizione lunghe 30 anni, Elleci crea soluzioni intelligenti con lo scopo di rendere più semplice la vita di tutti i giorni in cucina e lasciare spazio ai momenti che contano.

## 04 HERITAGE

06 EXPERTISE

08 SUSTAINABILITY

## 10 MATERIALS KERATEK | GRANITEK

14 CHOICES THAT MATTER

16 FLOW-PRO

## 18 EVERY DAY LIFE

20 BREAKFAST

22 LUNCH

24 HAPPY HOUR

26 DINNER

28-35 WHAT'S NEW

36 CARE FOR ATTENTION

## 38 PRODOTTI

44 LAVELLI IN COMPOSITO

128 LAVELLI INOX

140 ACCESSORI

152 MISCELATORI

172 PIANI COTTURA

186 FORNI

196 CAPPE E DISSIPATORI

200 ELLECI BEAUTY

202 SPARE PARTS

# HERITAGE

## A STORY TO TELL, AN EXPERIENCE TO SHARE.



Elleci guarda al futuro  
con occhi sempre nuovi.  
Una Company Culture che,  
basata sulla tradizione da cui  
si sviluppano le idee di domani,  
ha permesso di collezionare  
nel tempo importanti traguardi,  
innovando e proponendo  
un nuovo modo di vivere  
l'area preparazione in cucina.

### UNA STORIA DI SUCCESSO

*Tra i riconoscimenti più rilevanti,  
troviamo "Storie di Eccellenza"  
all'interno della Manifestazione  
100 Eccellenze, riservato  
alle aziende italiane che,  
con il loro lavoro, hanno  
contribuito a rafforzare  
i valori e lo spirito  
dell'ingegno nazionale.*



### EVOLUZIONE ARCHITETTONICA DEI COMPLESSI PRODUTTIVI

Dal 1992 a oggi, un'architettura pensata  
per visualizzare ogni volta  
l'espressione del proprio tempo.



**MIDA TERRA DI FRANCIA**  
Il 1° lavello prodotto.

# FOR 30 YEARS ALWAYS A STEP AHEAD.



## LEADERSHIP TECNOLOGICA

Ricerca, sperimentazione e tecnologie applicate accompagnano il prodotto dall'inizio alla fine del processo di creazione.

Gli anni passano, la passione per l'innovazione resta.  
Da 30 anni la voglia di migliorare è rimasta la stessa con idee in continuo aggiornamento e prodotti sempre attuali.

Dal principio alla prospettiva futura, il team Elleci è costantemente impegnato nella ricerca delle migliori soluzioni ergonomiche. Guidare l'evoluzione del gusto in cucina attraverso creatività e progresso tecnologico è il punto focale dell'azienda, per emozioni sempre nuove.



**SPAZIO 900**  
Red Dot Product Design 2023  
IF Design Award 2023

# EXPERTISE

## ANTICIPATING THE FUTURE IS THE BASIS OF OUR SUCCESS.



Il team di ricerca e sviluppo Elleci si compone di professionisti costantemente impegnati nella formulazione di soluzioni innovative, con una visione aziendale basata sullo sviluppo del know how interno e sul raggiungimento dell'eccellenza. Nuovi materiali extra resistenti, prodotti dal design intelligente e processi

produttivi della massima efficienza. Tra le innovazioni spicca il sistema G.P.S. (Granitek Production System) in grado di distribuire in maniera uniforme tutti i componenti inclusi nella massa in modo da conferire alle superfici un look & feel unico e una maggiore resistenza agli shock termici, all'abrasione e agli urti.

### INNOVATION FIRST.

Passione, dedizione e cura al dettaglio in ogni fase della filiera produttiva.

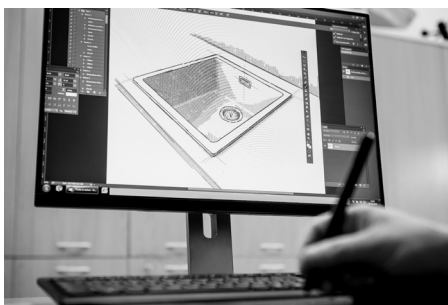



**CERTIFICAZIONI**  
**QUALITÀ CERTIFICATA AL 100%**



**ISO 9001/2015**  
 per la gestione della qualità a garanzia della soddisfazione del cliente, in termini di continuo sviluppo e miglioramento delle performance aziendali.



**ISO 14001/2015**  
 per la gestione ambientale in termini di corretto impatto dell'attività dell'azienda nell'ecosistema.



**ISO 45001/2018**  
 per la gestione della salute e della sicurezza sul lavoro aziendale.



Il materiale dei lavelli Elleci è altamente igienico ed idoneo al contatto alimentare in conformità alle norme e procedure imposte dall'ente.



I lavelli in composito Elleci sono conformi alle più rigorose normative in termini di livelli di emissione dei composti organici volatili.

Lavello\_Ego 500 G68 Bianco  
 Miscelatore\_Volta G68 Bianco

# SUSTAINABILITY

## FROM THE WORLD OF MATTER, FOR A WORLD THAT MATTERS.

L'innovazione è responsabilità e diviene sostenibile se affrontata con intelligenza. Pensare al domani e alle nuove generazioni vuol dire immaginare un futuro possibile per un mondo migliore.

L'impegno di Elleci si concentra sulla riduzione dell'impatto ambientale attraverso tutte le fasi produttive: dal design di prodotto alla scelta dei materiali e delle finiture, dalla progettazione e produzione fino alle soluzioni di smaltimento dei rifiuti e degli scarti.



PRODOTTO CERTIFICATO PER BASSE EMISSIONI CHIMICHE

UL.COM/GG  
UL2818



**ACQUA**  
RECUPERO  
RAFFREDDAMENTO  
E RE-IMMISSIONE



**ARIA**  
RIDUZIONI  
EMISSIONI  
DI CO2



**TERRA**  
RIUTILIZZO  
SCARTI  
DI PRODUZIONE



**FUOCO**  
PRODUZIONE ENERGIA  
DA FONTI RINNOVABILI

# OUR PATH TO A SUSTAINABLE FUTURE.

## INNOVAZIONE, SOSTENIBILITÀ E VISIONE ORIENTATA AL FUTURO.

Da anni Elleci rivolge le sue attenzioni verso pratiche di salvaguardia ambientale, cercando sempre nuove soluzioni per uno sviluppo aziendale sostenibile.

### 1\_ ELLECI HUB 1

Impianto produttivo storico incentrato sulla flessibilità e customizzazione della produzione.

### 2\_ ELLECI HUB 2

Impianto produttivo indipendente, altamente sostenibile e tecnologico in cui tradizione e know how incontrano modernità e automazione.

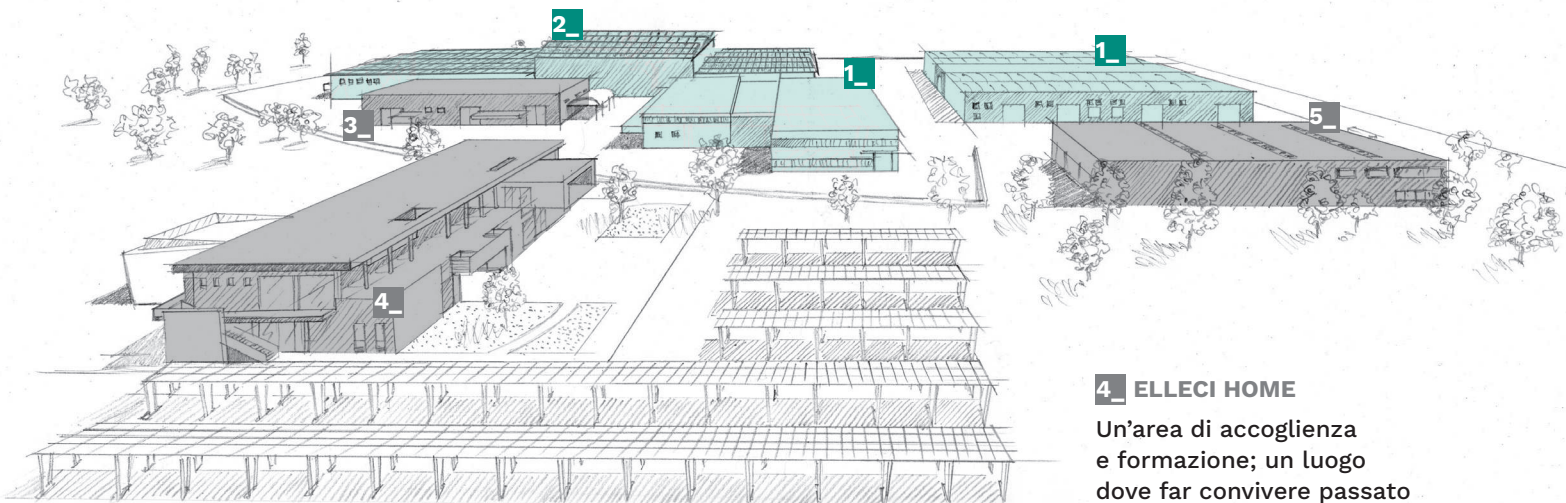

### 4\_ ELLECI HOME

Un'area di accoglienza e formazione; un luogo dove far convivere passato e visioni future. Un'esperienza completa del Mondo Elleci.

## 2 HUB PRODUTTIVI DIFFERENZIATI

**100.000 M2**  
PRODUTTIVI DIFFERENZIATI  
50.000 M2 AREA OPERATIVA COPERTA

**2,3 MW**  
DI ENERGIA PRODOTTA  
DA FONTI RINNOVABILI  
~50% FABBISOGNO ENERGETICO COMPLESSIVO

### 3\_ INNOVATION CENTER

Uno stabilimento dedicato alla ricerca e sviluppo dove le idee più ambiziose prendono forma.

### 5\_ ELLECI SERVICE

Valore e cura delle relazioni: questo spazio è completamente indirizzato a rafforzare il rapporto di fiducia con i clienti nelle fasi di pre e post vendita.

# MATERIALS

**KERATEK**<sup>®</sup>  
CERAMIC NANOTECHNOLOGY CN6

## DOES MATTER

Colori vividi, profondi e intensi che catturano lo sguardo a prima vista. Una superficie ultra liscia e sorprendentemente compatta crea un effetto seta al primo contatto.

**Keratek**, un materiale innovativo nato per sorprendere; una formulazione unica garantisce bellezza

e performance in termini di durevolezza, alta resistenza agli shock termici ed agli urti. Certificato NSF, è adatto al contatto con i cibi. Affascinante, igienico e facile da pulire, **è un materiale che conta, in ogni sua micro-particella.**

\*

20 ANNI · YEARS  
WARRANTY  
GARANTITO



\*

I lavelli hanno garanzia legale di 24 mesi. Solo effettuando la registrazione si può godere della garanzia convenzionale.

SUPERFICIE **SILK EFFECT**

DENSA, LISCIA E SETOSA AL TATTO, CONIUGA ALLA PERFEZIONE FUNZIONALITÀ ED ESTETICA.



FEATURES



SILKY  
SMOOTH  
FINISH



EASY  
TO  
CLEAN



DIRT  
REPELLENT  
EFFECT



INTENSE  
COLOURS

IMPROVEMENTS \*



HIGH  
SCRATCH  
RESISTANT



HOT WATER  
RESISTANT

K96 White

K93 Dove Grey

K97 Light Grey

K99 Dark Grey

K95 Champagne

K86 Black

# MATERIALS

**GRANITEK®**

NATURAL GRANITE EFFECT

## ENGINEERED QUARTZ

La materia a portata di mano. Nato dalla volontà di sfruttare in cucina la natura più tecnologica del quarzo è sostanza dall'aspetto importante.

Ultramaterica al tatto, resistente ai cambiamenti di temperatura e agli urti, è stata creata per durare nel tempo.

Grazie alla vasta gamma colori, suddivisa in tre differenti finiture, nessun dettaglio sarà trascurato, né al tatto né alla vista:

**Metal:**

La più chic. Grazie a tantissime particelle metalliche, la superficie sarà lucente, brillante e scintillante.

**Matt:**

Elegante e discreta. Una finitura raffinata, ideale per essere inserita in contesti moderni.

**Classic:**

La finitura dallo stile che non passa mai di moda. Un effetto pietra naturale, esaltato da texture cromatiche, perfette in ogni dettaglio.

10 ANNI · YEARS  
WARRANTY  
GARANTITO



### SUPERFICIE **NATURAL QUARTZ**

UNA FORMULAZIONE DALLA SUPERFICIE MATERICA INGEGNERISTICAMENTE STUDIATA PER ESALTARE LE MIGLIORI QUALITÀ DEL QUARZO.



\*

I lavelli hanno garanzia legale di 24 mesi. Solo effettuando la registrazione si può godere della garanzia convenzionale.

FEATURES



NATURAL  
QUARTZ  
FINISH



IMPACT  
RESISTANT



THERMAL  
SHOCK  
RESISTANT



MADE  
TO  
LAST

IMPROVEMENTS



NEW  
DEEP  
BLACK

METAL

M79 Aluminium

M73 Titanium

MATT

G68 Bianco

G48 Cemento

G43 Tortora

G78 Espresso

G40 Nero

CLASSIC

G62 Bianco Antico

G51 Avena

G59 Antracite

# CHOICES THAT MATTER

## PERFECT INSTALLATION

CHOOSE A COLOR \*



APPOGGIO



SOPRATOP

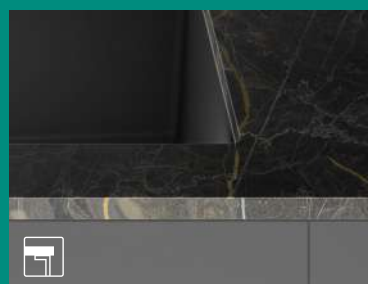

SOTTOTOP



FILOTOP

**Elleci propone quattro modalità di installazione** toccando più generi stilistici: partendo dall'installazione in Appoggio, tipica delle cucine dallo stile Farmhouse, passando per la tipica installazione Sopratop, sino ad arrivare alle installazioni dall'aspetto più contemporaneo come la Sottotop e la Filotop.

## ADD IDEAL MIXER<sup>◇</sup>



La scelta del miscelatore è importante per un'estetica integrata alle funzionalità del lavello e allo stile del resto della cucina; per questo Elleci propone due diversi tipi di abbinamento prodotti in modo da creare coerenza e uniformità:

### METAL FINISHINGS E FAMILY LINE <sup>◇</sup>

Mixers dalle finiture eleganti e raffinate, nati per sposarsi con i dettagli degli elettrodomestici Elleci.

### FULL COLOR E CONTINUITÀ \*

Mixers verniciati in ogni parte e componente del colore del lavello per un abbinamento perfetto e una sensazione di continuità totale.





# CHOOSE YOUR ACCESSORIES 3 LEVELS, MANY POSSIBILITIES.



Per un'ulteriore personalizzazione delle funzionalità lavello ed aggiungere valore alla workstation, una vasta gamma di accessori renderà ancora più piacevole l'esperienza in area preparazione.

Gli accessori si possono distribuire fino a **tre diversi piani di appoggio**, ottimizzando ogni livello-vasca del lavello per un utilizzo combinato.



## PERSONALIZE IT...

### DESIGN, IGIENE E DUREVOLEZZA.

Il tagliere in HPL (Laminato ad Alta Pressione) di Elleci è l'aggiunta speciale al lavello cucina. Estremamente robusto, resistente a graffi, urti e abrasioni, si caratterizza da una superficie non porosa che facilita la pulizia garantendo la massima igiene in cucina. È disponibile nelle colorazioni Nero, Grigio, Quercia, Olmo e Wood.



# FLOW PRO OPEN UP



## OPEN UP

COMANDO REMOTO  
AUTOMATICO DISPONIBILE  
SU RICHIESTA IN VERSIONE KIT.

L'eccellenza risiede nei più piccoli dettagli. Con la massima attenzione alla funzionalità ed al design del prodotto, il sistema di scarico cambia aspetto. La piletta dallo stile ricercato garantisce una continuità estetica all'interno della vasca mentre l'ergonomia del comando centrale ne favorisce l'utilizzo.



## FLOW PRO

Cambia il concetto di piletta in un sistema di scarico moderno, pratico e semplice nell'utilizzo e nella manutenzione.



Sistema di scarico Flow Pro in versione Black Matt.



Sistema di scarico Flow Pro in versione Oro spazzolato.

## OPEN UP



Open Up è il comodo ed elegante comando remoto per pilette che ne consente l'apertura e la chiusura automatica attraverso un semplice azionamento a pressione, senza dover immergere la mano nella vasca.



# EVERY DAY USE

**Dal risveglio alla sera, la workstation è la compagnia ideale per ogni momento della giornata.**

Dopo anni di ricerca applicata all'uso del vivere la cucina, nasce un'area preparazione che sorprende ad ogni nuovo gesto. Accessori integrati alla postazione ottimizzano ogni movimento e riducono al minimo l'ingombro sul top cucina. Colazione, brunch, merende, aperitivi e cene: la preparazione all-in, dal taglio alla degustazione.



#### **VASCHETTA COLANDER**

L'accessorio ideale per organizzare e scolare.





**MISCELATORE WAVE CROMO**

Il mixer brillante nell'estetica e nelle funzionalità. Caratterizzato da un elegante design bicolore, si compone di un'alta canna girevole ergonomica in silicone nero matt, con doccetta estraibile in grado di raggiungere facilmente tutti gli angoli vasca.



**TAGLIERE ELEMENT BLACK**

Il tagliere multifunzione dotato di pratiche scanalature per un uso integrato al lavello o in appoggio su top cucina.



# EVERY DAY USE

## BREAKFAST



**Mani nell'impasto, uova rotte e una buona dose di dolcezza per una ricetta gustosissima.**

Il nuovo modello **Spazio 900** è caratterizzato da linee pulite e dalla vasca XL, profonda e capiente, in grado di ospitare anche le pentole e le teglie da forno più grandi.

lavello\_Spazio 900 K96 Bianco  
miscelatore\_Arcadia Cromato

**Il design farm house rivisitato in chiave contemporanea,**  
 si adatta sia ad ambienti moderni che classici e, grazie  
 alla generosa capienza della vasca ed ai taglieri multifunzione,  
 l'area preparazione diventa una workstation a tutti gli effetti.



# EVERY DAY USE

## LUNCH



lavello\_Life 480 G78 Espresso  
miscelatore\_Trail G78 Espresso







**Il momento della giornata dedicato al piacere del ritrovo familiare e della condivisione.**

**Life 480** è il perfetto alleato ed entra nella famiglia Elleci con un design concreto, essenziale e moderno. Attraverso forme e linee discrete, un ampio gocciolatoio ed un set di accessori come taglieri multiuso, è ottimo per l'uso quotidiano in quanto soddisfa ogni necessità in famiglia.

EVERY  
DAY USE

HAPPY HOUR



lavello inox\_Compass 700  
miscelatore\_Flux Cromato  
piano cottura a induzione\_Urban 60



**Spazio alla socialità,  
è tempo di rilassarsi e bere  
un buon cocktail con gli amici.**

Varie preparazioni e tante mini ricette trovano il giusto alleato in cucina; il lavello inox **Compass** con una vasca di grandi dimensioni, un set di accessori multifunzione abbinato all'innovativo miscelatore Flux con doccetta estraibile renderà tutto più semplice e veloce.

# EVERY DAY USE

## DINNER



**Momento introspettivo e generoso,  
elegante e conviviale in cui tirare le somme  
della giornata trascorsa di fronte  
ad un buon piatto, perchè no, anche gourmet!**

Come una vera postazione professionale,  
la workstation essenziale **Best 105** è ideale  
anche per fasi di preparazione articolate.

lavello in composito\_Best 105 K86 Black  
miscelatore\_Hype Black Matt  
piano cottura a induzione\_Urban 80



WHAT'S **NEW**

# NUOVI LAVELLI

**UNA COLLEZIONE  
DI LAVELLI COMPLETA  
E DIVERSIFICATA  
NELL'ESTETICA  
E NELLA FUNZIONALITÀ,  
SI ARRICCHISCE DI TRE  
NUOVI MODELLI.**

**Spazio 900**, caratterizzato dall'ampia vasca e dallo stile più tradizionale, rivoluziona l'estetica farmhouse, rendendola fresca e attuale.

Segue la workstation **Best 105**, una soluzione estremamente ergonomica e dall'animo essenziale. Si compone di una profonda vasca singola con suddivisione a tre livelli e bordo salvagoccia che permette lo scorrimento degli accessori lungo tutto il lavello.

Perfetta anche per gli ambienti più ristretti, troviamo infine **Life 410**, il lavello lineare in cui lo stile classico abbraccia la modernità attraverso forme e linee discrete.

Cucina contemporanea  
**lavello\_Best 105 K86 Black**  
**miscelatore\_Hype Black Matt**

Ambiente Farmhouse  
**lavello\_Spazio 900 K96 White** in appoggio  
**miscelatore\_Arcadia Black Matt**

Cucina lineare ad angolo  
**lavello\_Life 480 G78 Espresso**  
**miscelatore\_Trail G78 Espresso**





WHAT'S **NEW**

# NUOVE FINITURE

Le nuove finiture dalle cromie lucenti esaltano le forme estetiche dei miscelatori e della componentistica, impreziosendo ogni loro dettaglio. Le nuove finiture **Black Matt, Cromo, Cromo spazzolato ed Oro spazzolato**, sono nate per donare un aspetto moderno ed affascinante al piano lavoro.







WHAT'S **NEW**

# NUOVI MISCELATORI





**E DOPO L'ABITO  
È GIUSTO CAMBIARE  
ANCHE LA SOSTANZA.**

**Club, Hype, Kent e Arcadia**  
le quattro nuove forme inedite  
dall'animo contemporaneo  
per un'area di preparazione  
seducente ed un protagonismo  
discreto e raffinato.

Sulla sinistra miscelatore Arcadia Black Matt | Club Cromato Spazzolato

Sopra miscelatore Kent Oro spazzolato | Miscelatore Hype Black Matt

WHAT'S **NEW**

# TOTAL GLASS\_ **BLACK IS BACK** FOR UNLIMITED **MATCHING**

Il mondo Elleci si compone di forni, piani cottura, accessori, miscelatori e complementi in grado di coordinarsi perfettamente con i colori dei lavelli in composito, dando vita ad una Family Line cromatica che genera armonia nell'area preparing.

lavello in composito\_Zen 130 K86 Black  
miscelatore\_Kent Black Matt  
microonde\_Urban  
forno\_Urban Plus  
induzione\_Urban 80

**LA LINEA TOTAL GLASS SI TINGE DI NERO.**

Il vetro è un materiale moderno e raffinato ed entra in gioco quando si parla di elettrodomestici dallo stile contemporaneo. Una linea ampia, composta di forni, microonde, piani cottura gas on glass e a induzione, si riveste di superfici in vetro estremamente lisce che impreziosiscono la base nera con giochi di luce dall'effetto brillante.

**ANCHE LA BLACK FAMILY LINE SCEGLIE DI SCHIERARSI IN CUCINA CON IL COLORE NERO PER VESTIRSI DI INTRAMONTABILE ELEGANZA.**

Ogni dettaglio è pensato per integrarsi in total look agli altri elementi, come le finiture di componenti ed accessori per un nero totale delicato alla vista e al tatto.

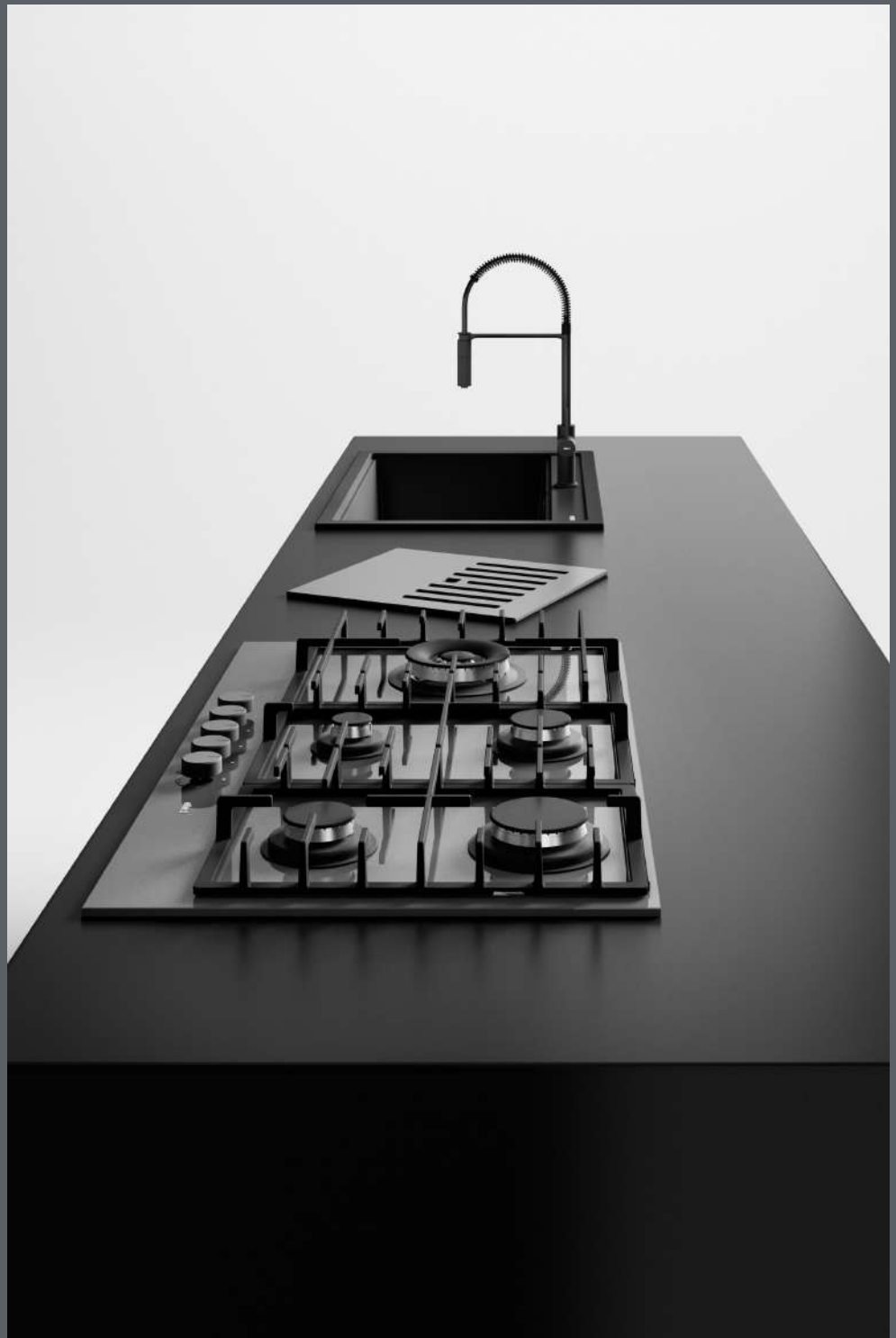

lavello in composito\_Best 130 K86 Black  
 miscelatore\_Arcadia Black Matt  
 piano cottura\_Urban Gas on Glass 90

# CARE FOR ATTENTION



## SUPPORTO E ASSISTENZA

Costantemente impegnata nell'offrire ai propri clienti un servizio efficiente e professionale, il progetto di **Customer Care di Elleci** si proietta sulle relazioni e sul valore di queste ultime.

È con questi presupposti che nasce **Elleci Service**: una possibilità concreta per costruire un rapporto con i clienti ed aumentare l'esperienza di acquisto nonché la soddisfazione attraverso un servizio di risposta tempestivo e qualificato dal pre vendita al post vendita.



**SCOPRI**  
LA PAGINA  
DEDICATA  
**AL SUPPORTO**  
**E ASSISTENZA**



WEBSITE  
[www.elleci.com/it](http://www.elleci.com/it)



CHIAMACI AL NUMERO VERDE  
**800.800.803**

# REGISTRAZIONE

REGISTRARE IL LAVELLO ELLECI SUL SITO, CONVIENE!

Basterà scannerizzare il QR code al lato e compilare l'anagrafica. Durante questa fase verranno richiesti i dati del prodotto, occorrerà solamente tenerli accanto durante tutta la fase di registrazione.



INQUADRA QUI  
CON IL TUO  
SMARTPHONE

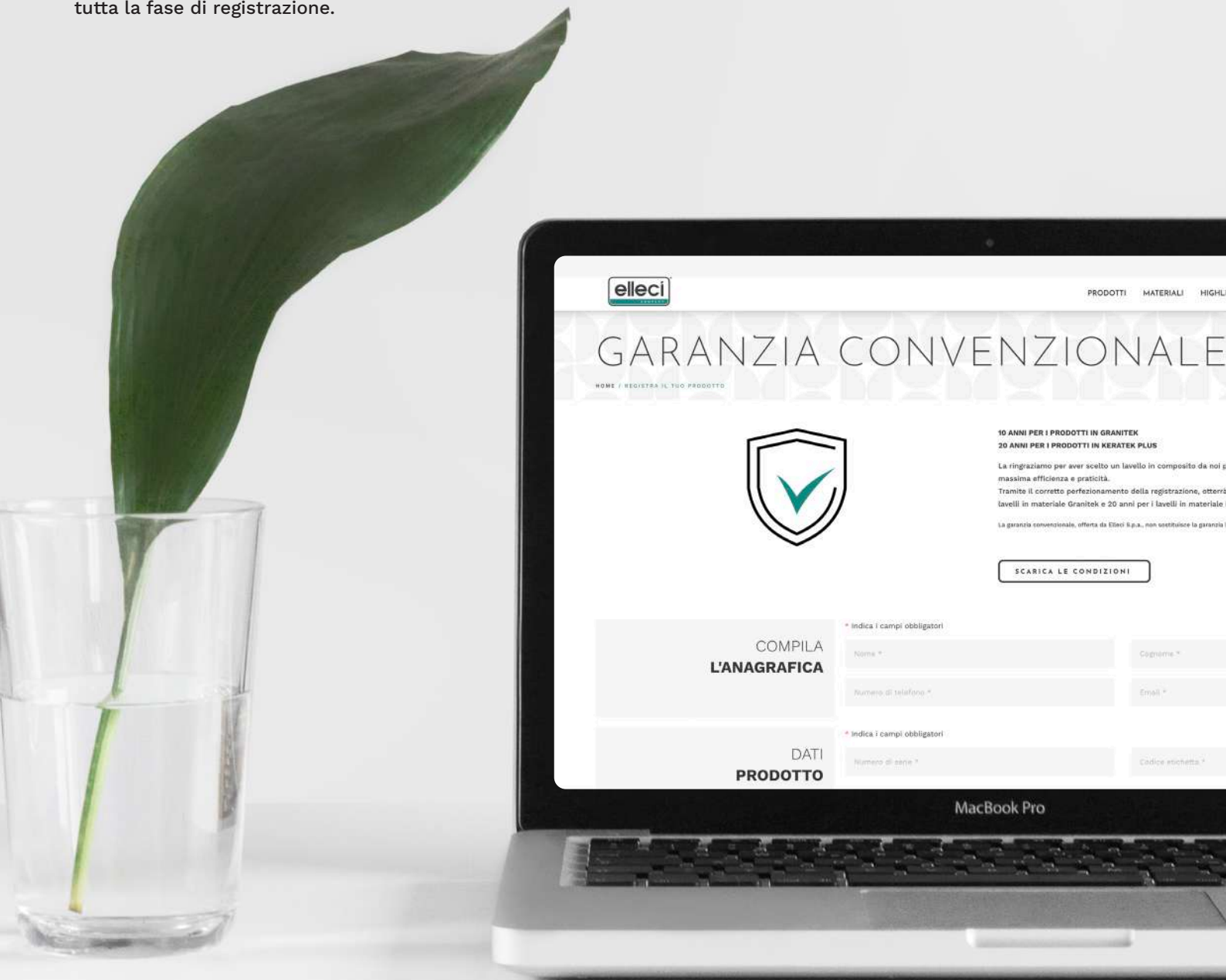

## GARANZIA CONVENZIONALE\*

**10 ANNI** DI GARANZIA PER I LAVELLI IN **GRANITEK**

**20 ANNI** DI GARANZIA PER I LAVELLI IN **KERATEK**

In seguito all'acquisto di un lavello Elleci ed alla fase di registrazione di quest'ultimo, si otterrà l'estensione della garanzia a 10 anni per i lavelli in materiale Granittek e 20 anni per i lavelli in materiale Keratek.

\* La garanzia convenzionale, offerta da Elleci S.p.a., non sostituisce la garanzia legale offerta dal venditore, ma si affianca ad essa.

# INDICE COLLEZIONI LAVELLI

**NEW**

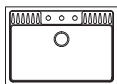

**SPAZIO 900**  
PAG. 46

**NEW**

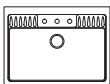

**SPAZIO EXTRA**  
PAG. 46

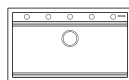

**BEST 360**  
PAG. 50

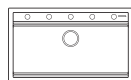

**BEST 360 BUNDLE**  
PAG. 50

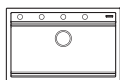

**BEST 130**  
PAG. 51

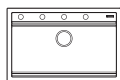

**BEST 130 BUNDLE**  
PAG. 51

**NEW**



**BEST 105**  
PAG. 52

**NEW**



**BEST 104**  
PAG. 52

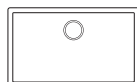

**ZEN/ZEN F 130**  
PAG. 56-60

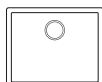

**ZEN/ZEN F 105**  
PAG. 56-60



**ZEN/ZEN F 102**  
PAG. 57-61

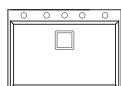

**KARISMA 120**  
SOPRATOP  
PAG. 64

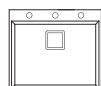

**KARISMA 105**  
SOPRATOP  
PAG. 64

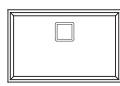

**KARISMA 120**  
SOTTOTOP  
PAG. 65



**KARISMA 105**  
SOTTOTOP  
PAG. 65

**NEW**

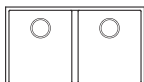

**INTEGRA 350**  
PAG. 68

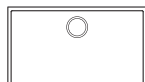

**INTEGRA 130**  
PAG. 68

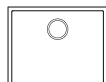

**INTEGRA 105**  
PAG. 69



**INTEGRA 102**  
PAG. 69

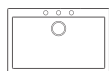

**QUADRA 130**  
SOPRATOP  
PAG. 72



**QUADRA 110**  
SOPRATOP  
PAG. 72



**QUADRA 105**  
SOPRATOP  
PAG. 73



**QUADRA 102**  
SOPRATOP  
PAG. 73



**QUADRA 100**  
SOPRATOP  
PAG. 74



**QUADRA 50**  
SOPRATOP  
PAG. 74

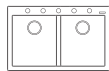

**QUADRA 350**  
SOPRATOP  
PAG. 75

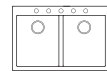

**QUADRA 340**  
SOPRATOP  
PAG. 75

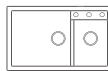

**QUADRA 440**  
SOPRATOP  
PAG. 76



**QUADRA 150**  
SOPRATOP  
PAG. 76

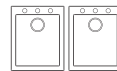

**QUADRA 200**  
SOPRATOP  
PAG. 77

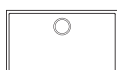

**QUADRA 130**  
SOTTOTOP  
PAG. 80



**QUADRA 110**  
SOTTOTOP  
PAG. 80



**QUADRA 105**  
SOTTOTOP  
PAG. 81



**QUADRA 102**  
SOTTOTOP  
PAG. 81



**QUADRA 100**  
SOTTOTOP  
PAG. 82



**QUADRA 50**  
SOTTOTOP  
PAG. 82

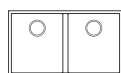

**QUADRA 350**  
SOTTOTOP  
PAG. 83

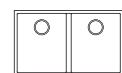

**QUADRA 340**  
SOTTOTOP  
PAG. 83

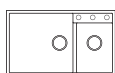

**QUADRA 440**  
SOTTOTOP  
PAG. 84



**QUADRA 150**  
SOTTOTOP  
PAG. 84

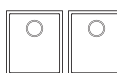

**QUADRA 200**  
SOTTOTOP  
PAG. 85



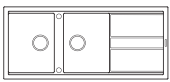

**BEST 500**  
PAG. 88

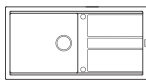

**BEST 480**  
PAG. 88

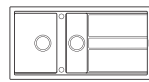

**BEST 475**  
PAG. 89

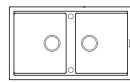

**BEST 450**  
PAG. 89

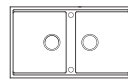

**BEST 450**  
SOTTOTOP  
PAG. 90

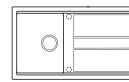

**BEST 400**  
PAG. 90

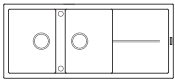

**UNICO 500**  
PAG. 94

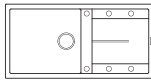

**UNICO 480**  
PAG. 94

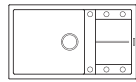

**UNICO 410**  
PAG. 95

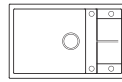

**UNICO 310**  
PAG. 95

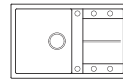

**UNICO 300**  
PAG. 96

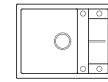

**UNICO 125**  
PAG. 96

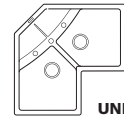

**UNICO CORNER**  
PAG. 97

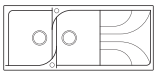

**EGO 500**  
PAG. 100

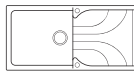

**EGO 480**  
PAG. 100

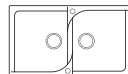

**EGO 450**  
PAG. 101

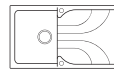

**EGO 400**  
PAG. 101



**EGO ROUND**  
PAG. 102

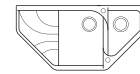

**EGO ESA**  
PAG. 102

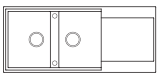

**EASY 500**  
PAG. 106

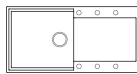

**EASY 480**  
PAG. 106

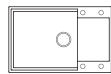

**EASY 310**  
PAG. 107

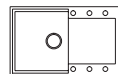

**EASY 300**  
PAG. 107

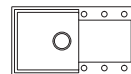

**EASY 290**  
PAG. 108



**EASY 135**  
PAG. 108

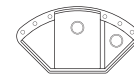

**EASY CORNER**  
PAG. 109



**EASY ROUND 60**  
PAG. 109

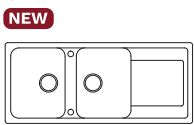

**NEW**

**LIFE 500**  
PAG. 112

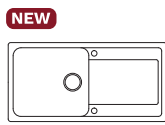

**NEW**

**LIFE 480**  
PAG. 112

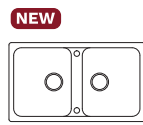

**NEW**

**LIFE 450**  
PAG. 113

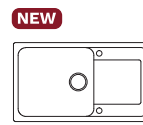

**NEW**

**LIFE 410**  
PAG. 113

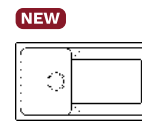

**NEW**

**LIFE 400**  
PAG. 114

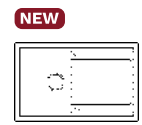

**NEW**

**LIFE 300**  
PAG. 114

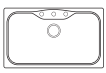

**FOX 360**  
PAG. 118



**FOX 200**  
PAG. 118



**FOX 180**  
PAG. 119



**FOX ROUND**  
PAG. 119

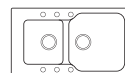

**FOX 430**  
PAG. 120

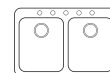

**FOX 340**  
PAG. 120

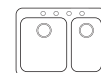

**FOX 330**  
PAG. 121

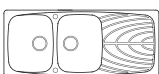

**MASTER 500**  
PAG. 124

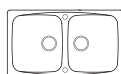

**MASTER 450**  
PAG. 124

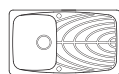

**MASTER 400**  
PAG. 125

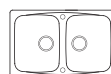

**MASTER 350**  
PAG. 125

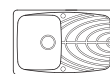

**MASTER 300**  
PAG. 126

## INDICE COLLEZIONI LAVELLI INOX

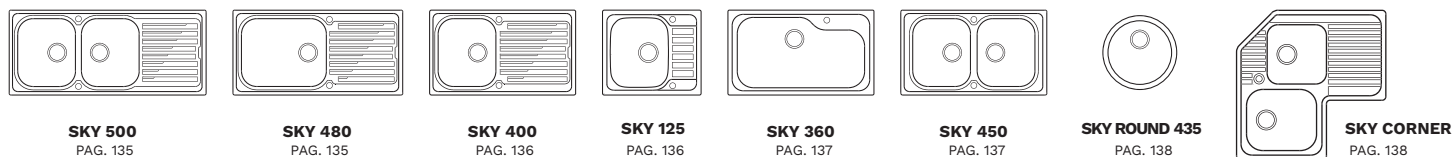
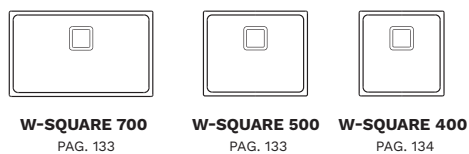
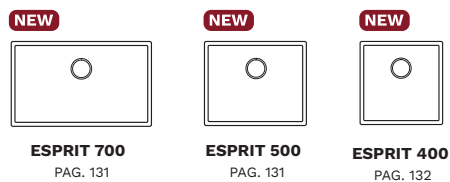
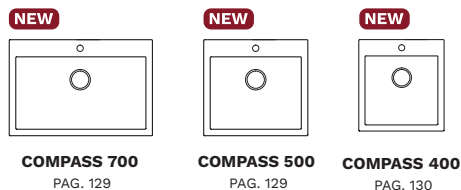

## INDICE COLLEZIONI ACCESSORI

### ACCESSORI ELEMENT

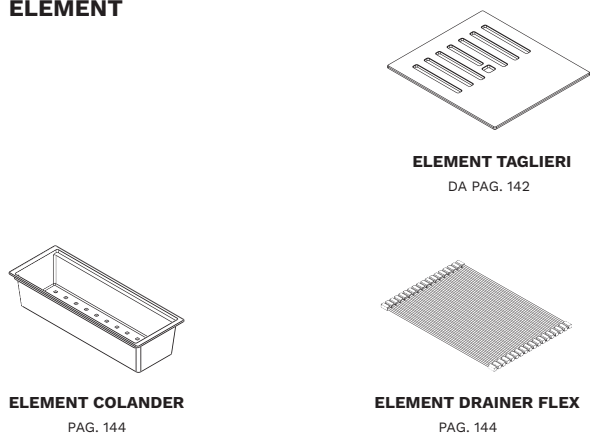

### OPTIONAL

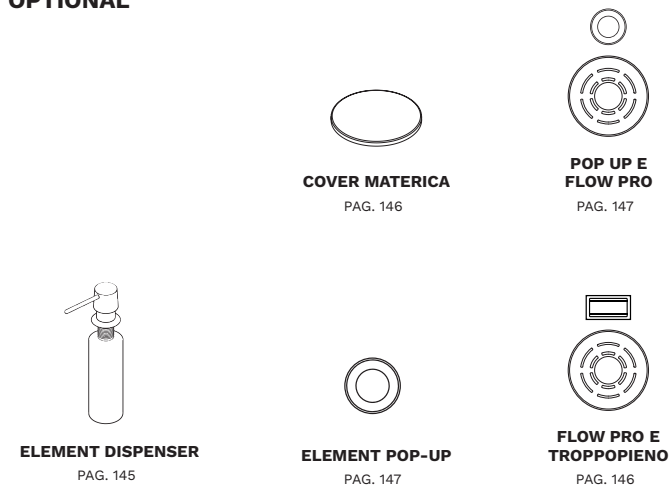

### ACCESSORI VARI



INDICE MISCELATORI

PROFESSIONAL

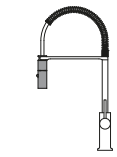

**NEW** **ARCADIA**  
PAG. 154

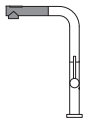

**FLUX**  
PAG. 155

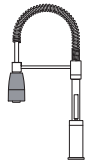

**CHEF**  
PAG. 156

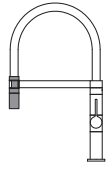

**WAVE**  
PAG. 154

CANNA L

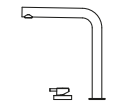

**NEW** **KENT**  
PAG. 155

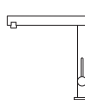

**TEMA**  
PAG. 156

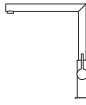

**ARES**  
PAG. 157

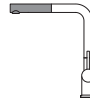

**STREAM PLUS**  
PAG. 158

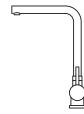

**DANUBIO**  
PAG. 165

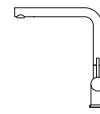

**STREAM**  
PAG. 158

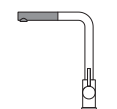

**TRAIL PLUS**  
PAG. 159

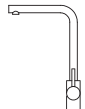

**TRAIL**  
PAG. 159

FILTRANTE

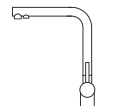

**TOURMALINE**  
PAG. 160

CANNA A PONTE

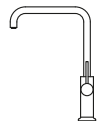

**NEW** **HYPE**  
PAG. 157

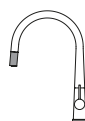

**NEW** **ATHENA PLUS**  
PAG. 161

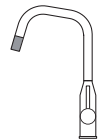

**DORA PLUS**  
PAG. 162



**VOLTA**  
PAG. 164

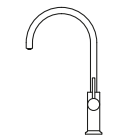

**NEW** **CLUB**  
PAG. 163

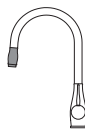

**NEVA**  
PAG. 165

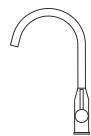

**ADIGE**  
PAG. 162



**ATHENA**  
PAG. 161



**BRIDGE**  
PAG. 163



**CLOUD**  
PAG. 164

TRADITIONAL

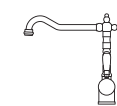

**RIO**  
PAG. 169



**RENO**  
PAG. 166



**SENNA**  
PAG. 167



**SAVA**  
PAG. 166

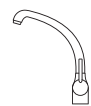

**PO**  
PAG. 167



**VENERE**  
PAG. 168



**MINERVA**  
PAG. 168

## INDICE COLLEZIONI PIANI COTTURA

NEW

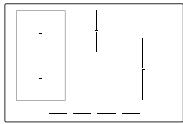

**URBAN  
INDUCTION 80**  
PAG. 172

NEW

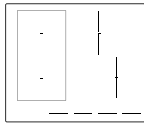

**URBAN  
INDUCTION 60**  
PAG. 173

NEW



**URBAN  
INDUCTION 30**  
PAG. 173

NEW

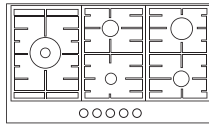

**URBAN  
GAS ON GLASS 90**  
PAG. 174

NEW

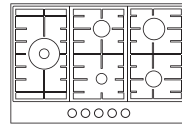

**URBAN  
GAS ON GLASS 75**  
PAG. 175

NEW

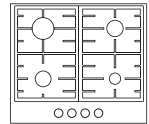

**URBAN  
GAS ON GLASS 60**  
PAG. 175

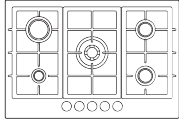

**PLANO PLUS 75**  
PAG. 176

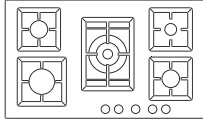

**PLANO 90**  
PAG. 178

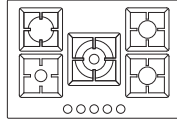

**PLANO 75**  
PAG. 180

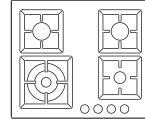

**PLANO 60**  
PAG. 181

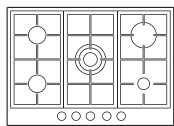

**STYLE 75**  
PAG. 182

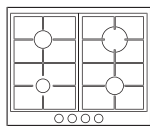

**STYLE 60**  
PAG. 183

NEW

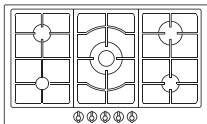

**COUNTRY 90**  
PAG. 184

NEW

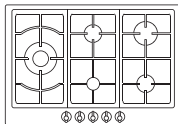

**COUNTRY 75**  
PAG. 185

## INDICE COLLEZIONI FORNI

NEW

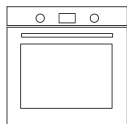

**URBAN PLUS**  
PAG. 186

NEW

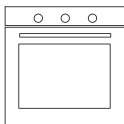

**URBAN**  
PAG. 187

NEW

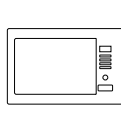

**URBAN MICROONDE**  
PAG. 187

NEW



**PLANO PLUS**  
PAG. 188

NEW

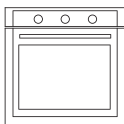

**PLANO**  
PAG. 190

NEW

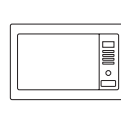

**PLANO MICROONDE**  
PAG. 192

NEW

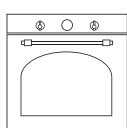

**COUNTRY**  
PAG. 194

INDICE COLLEZIONI CAPPE

---

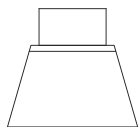

**BRIO**  
PAG. 197



**URBAN**  
PAG. 197

INDICE COLLEZIONI DISSIPATORI

---



**MODELLO 1000 TOP**  
PAG. 199



**MODELLO 750 TOP**  
PAG. 199



**MODELLO 750**  
PAG. 199

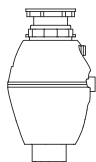

**MODELLO 500 TOP**  
PAG. 199

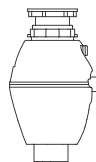

**MODELLO 500**  
PAG. 199



MAGGIORI  
INFORMAZIONI  
LINEA SPAZIO



### IL FARMHOUSE MODERNO

Le geometrie dello Spazio permettono di sfruttare al massimo il volume della vasca extralarge in modo intelligente ed estremamente razionale. Il bordo interno che permette lo scorrimento degli accessori costituisce un'esperienza di utilizzo estremamente confortevole nelle fasi di Preparing e Cleaning.

  
red dot winner 2023



## PLUS SPAZIO



ACCESSORI  
ELEMENT



FLOW PRO



VASCA XL

**KERATEK**<sup>®</sup>  
CERAMIC NANOTECHNOLOGY CN6

-  **Black**  
K86
-  **Dove Grey**  
K93
-  **Champagne**  
K95
-  **White**  
K96
-  **Light Grey**  
K97
-  **Dark Grey**  
K99

## I MODELLI SPAZIO

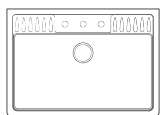

SPAZIO **900**

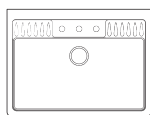

SPAZIO **900 EXTRA**

**Corredo del lavello:** Sifone salvaspazio, piletta Flow Pro integrata, troppopieno rettangolare e ganci.

## ACCESSORI CONSIGLIATI

193

**ELEMENT  
TAGLIERE SPAZIO**  
ATH123WD  
Pag. **142**



**Finiture**



Black Wood

## IL PERFETTO MATCH MISCELATORI



**ARCADIA - Black BK**  
MOKARCBK

Pag. **154**

Disponibile nelle colorazioni

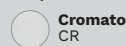

Cromato  
CR



Black  
BK

## OPTIONAL

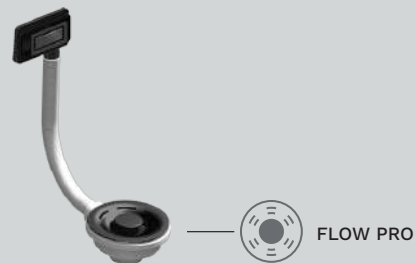

KIT ELEMENT  
**FLOW PRO + TROPPO PIENO BLACK**  
KITWPT-F-1VSLL-BK

Pag. **146**

## elleci | BEAUTY



Una linea di prodotti appositamente studiata per la cura dei lavelli in composito.

Scopri di più a pag. **200**

\*Per ulteriori informazioni vai alla sezione accessori a pag. **140**

# SPAZIO 900 NEW



White  
K96

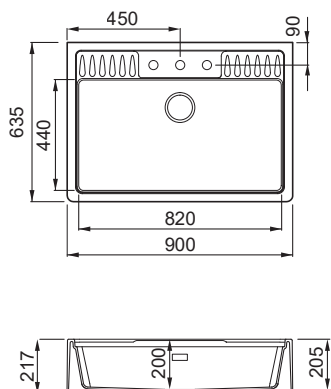

## OPTIONAL



Pag. 146

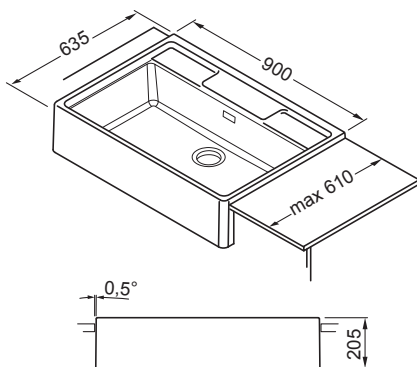

## MATERIALI E COLORI

KERATEK CERAMIC NANOTECHNOLOGY DNR		Euro 1200
	<b>Black</b> K86	LKS90086
	<b>Dove Grey</b> K93	LKS90093
	<b>Champagne</b> K95	LKS90095
	<b>White</b> K96	LKS90096
	<b>Light Grey</b> K97	LKS90097
	<b>Dark Grey</b> K99	LKS90099

## Lavello 1 vasca

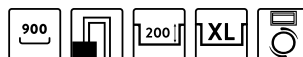

## CARATTERISTICHE

Dimensioni (mm)	<b>900 x 635</b>
Base (mm)	<b>900</b>
Foro da incasso (mm)	<b>Da dima*</b>
Profondità Vasca (mm)	<b>200</b>
Installazione	<b>Appoggio</b>
Orientamento	<b>Non reversibile</b>

## ACCESSORI CONSIGLIATI

193

\*dima inclusa nella confezione o scaricabile dalla sezione download specifica del sito [www.elleci.com/it](http://www.elleci.com/it)

# SPAZIO 900 EXTRA NEW



White  
K96

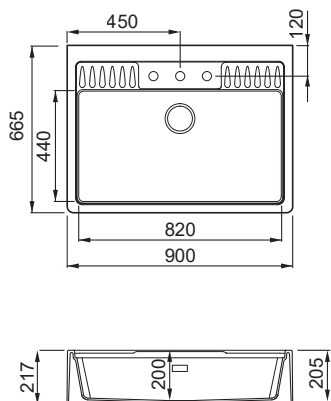

## OPTIONAL



Pag. 146

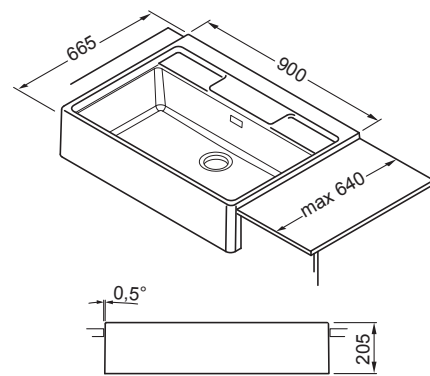

## MATERIALI E COLORI

KERATEK CERAMIC NANOTECHNOLOGY DNR		Euro 1200
	<b>Black</b> K86	LKS90086XLP
	<b>Dove Grey</b> K93	LKS90093XLP
	<b>Champagne</b> K95	LKS90095XLP
	<b>White</b> K96	LKS90096XLP
	<b>Light Grey</b> K97	LKS90097XLP
	<b>Dark Grey</b> K99	LKS90099XLP

## Lavello 1 vasca

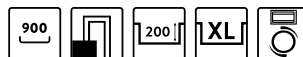

## CARATTERISTICHE

Dimensioni (mm)	<b>900 x 665</b>
Base (mm)	<b>900</b>
Foro da incasso (mm)	<b>Da dima*</b>
Profondità Vasca (mm)	<b>200</b>
Installazione	<b>Appoggio</b>
Orientamento	<b>Non reversibile</b>

## ACCESSORI CONSIGLIATI

193

\*dima inclusa nella confezione o scaricabile dalla sezione download specifica del sito [www.elleci.com/it](http://www.elleci.com/it)





COLLEZIONE  
**BEST WORKSTATION**



MAGGIORI  
INFORMAZIONI  
LINEA BEST WORKSTATION



**LA WORKSTATION PER ECCELLENZA**

Una cucina ben organizzata è un'ottima base di partenza per realizzare ogni ricetta: la Best Workstation si compone di una vasca XL e di una serie di accessori progettati appositamente per avere tutto a portata di mano. Il colander in polipropilene, il drainer flex in silicone, il tagliere in HPL, il pop-up control rendono tutto più semplice e realizzabile.

PLUS **BEST  
WORKSTATION**



ACCESSORI  
ELEMENT







FLOW PRO



3 LIVELLI

**GRANITEK**  
NATURAL GRANITE EFFECT

-  **Titanium**  
M73
-  **Aluminium**  
M79
-  **Nero**  
G40
-  **Tortora**  
G43
-  **Cemento**  
G48
-  **Bianco**  
G68
-  **Espresso**  
G78

-  **Avena**  
G51
-  **Antracite**  
G59
-  **Bianco Antico**  
G62

**KERATEK**  
CERAMIC NANOTECHNOLOGY CN6

-  **Black**  
K86
-  **Dove Grey**  
K93
-  **Champagne**  
K95
-  **White**  
K96
-  **Light Grey**  
K97
-  **Dark Grey**  
K99

## I MODELLI BEST WORKSTATION

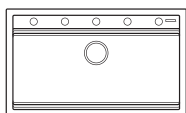

BEST **360**

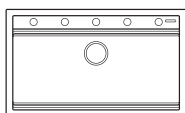

BEST **360 BUNDLE**

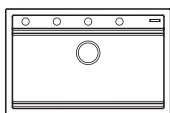

BEST **130**

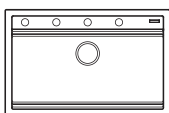

BEST **130 BUNDLE**

**Corredo del lavello:** Sifone salvaspazio, piletta Flow Pro integrata, troppopieno rettangolare e ganci.

**Corredo del lavello Bundle:** Colander, Drainer Flex, sifone salvaspazio, piletta Flow Pro integrata, troppopieno integrato e ganci.

## ACCESSORI CONSIGLIATI

93

**ELEMENT TAGLIERE  
BEST WORKSTATION**  
ATH073QU  
Pag. **143**



### Finiture

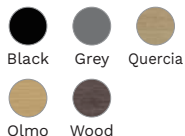

156

**ELEMENT DRAINER  
FLEX 500**  
ARS023BK  
Pag. **144**



### Finiture



153

**ELEMENT COLANDER  
BEST WORKSTATION**  
AVP034BK  
Pag. **144**



### Finiture



97

**ELEMENT POP-UP  
PUSH CONTROL**  
ASP13002BK  
Pag. **147**



### Finiture



## IL PERFETTO MATCH MISCELATORI



**WAVE - Black BK**  
MOKWAVBK

Pag. **154**

Disponibile nelle colorazioni



## OPTIONAL

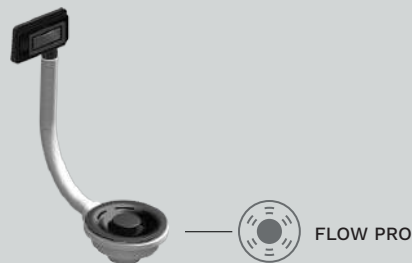

KIT ELEMENT  
**FLOW PRO + TROPPO PIENO BLACK**  
KITWPT-F-1VSL-L-BK

Pag. **146**

## elleci | BEAUTY



Una linea di prodotti appositamente studiata per la cura dei lavelli in composito.

Scopri di più a pag. **200**

\*Per ulteriori informazioni vai alla sezione accessori a pag. **140**

# BEST 360



White  
K96

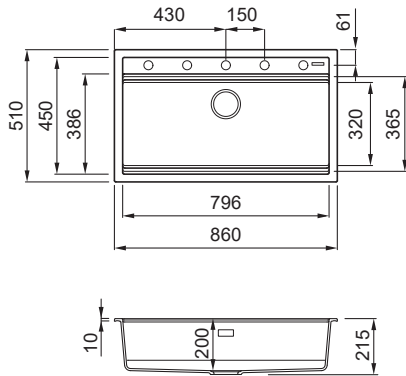

## OPTIONAL



Pag. 146

## Lavello 1 vasca



## CARATTERISTICHE

Dimensioni (mm)	<b>860 x 510</b>
Base (mm)	<b>900</b>
Foro da incasso (mm)	<b>840 x 480</b>
Profondità Vasca (mm)	<b>200</b>
Installazione	<b>Sopratop</b>
Orientamento	<b>Non reversibile</b>

## ACCESSORI CONSIGLIATI

93	97	25	50	153	156	163
164	5	75	71	9		

## MATERIALI E COLORI

<b>KERATEK</b> GERMIC NANOTECHNOLOGY DNR	Euro <b>698</b>
<b>Black</b> K86	LKB36086
<b>Dove Grey</b> K93	LKB36093
<b>Champagne</b> K95	LKB36095
<b>White</b> K96	LKB36096
<b>Light Grey</b> K97	LKB36097
<b>Dark Grey</b> K99	LKB36099

<b>GRANITEK</b> NATURAL GRANITE EFFECT	Euro <b>546</b>
<b>METAL</b>	
<b>Titanium</b> M73	LMB36073
<b>Aluminium</b> M79	LMB36079

	Euro <b>524</b>
<b>MATT</b>	
<b>Nero</b> G40	LGB36040
<b>Tortora</b> G43	LGB36043
<b>Cemento</b> G48	LGB36048
<b>Bianco</b> G68	LGB36068
<b>Espresso</b> G78	LGB36078

	Euro <b>524</b>
<b>CLASSIC</b>	
<b>Avena</b> G51	LGB36051
<b>Antracite</b> G59	LGB36059
<b>Bianco Antico</b> G62	LGB36062

# BEST 360 BUNDLE



White  
K96

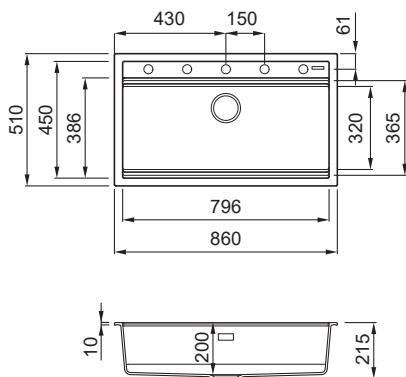

## Lavello 1 vasca con Flex Drainer e colander inclusi



## CARATTERISTICHE

Dimensioni (mm)	<b>860 x 510</b>
Base (mm)	<b>900</b>
Foro da incasso (mm)	<b>840 x 480</b>
Profondità Vasca (mm)	<b>200</b>
Installazione	<b>Sopratop</b>
Orientamento	<b>Non reversibile</b>

## ACCESSORI CONSIGLIATI

93	97	25	50	163	164	5
75	71	9				

## MATERIALI E COLORI

<b>KERATEK</b> GERMIC NANOTECHNOLOGY DNR	Euro <b>828</b>
<b>Black</b> K86	LKB36086K2
<b>Dove Grey</b> K93	LKB36093K2
<b>Champagne</b> K95	LKB36095K2
<b>White</b> K96	LKB36096K2
<b>Light Grey</b> K97	LKB36097K2
<b>Dark Grey</b> K99	LKB36099K2

<b>GRANITEK</b> NATURAL GRANITE EFFECT	Euro <b>681</b>
<b>METAL</b>	
<b>Titanium</b> M73	LMB36073K2
<b>Aluminium</b> M79	LMB36079K2

	Euro <b>657</b>
<b>MATT</b>	
<b>Nero</b> G40	LGB36040K2
<b>Tortora</b> G43	LGB36043K2
<b>Cemento</b> G48	LGB36048K2
<b>Bianco</b> G68	LGB36068K2
<b>Espresso</b> G78	LGB36078K2

	Euro <b>657</b>
<b>CLASSIC</b>	
<b>Avena</b> G51	LGB36051K2
<b>Antracite</b> G59	LGB36059K2
<b>Bianco Antico</b> G62	LGB36062K2

# BEST 130



Light Grey  
K97

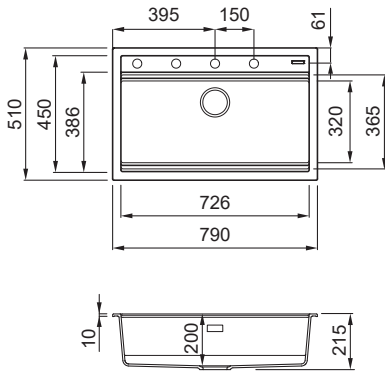

### OPTIONAL



Pag. 146

### Lavello 1 vasca

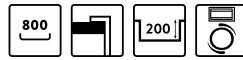

### CARATTERISTICHE

Dimensioni (mm) **790 x 510**  
 Base (mm) **800**  
 Foro da incasso (mm) **770 x 480**  
 Profondità Vasca (mm) **200**  
 Installazione **Sopratop**  
 Orientamento **Non reversibile**

### ACCESSORI CONSIGLIATI

93	97	25	50	153	156	163
164	5	75	71	9		

### MATERIALI E COLORI

<b>KERATEX</b> GERAM: NANOTECHNOLOGY ONE	Euro <b>698</b>
● <b>Black</b> K86	LKB13086
● <b>Dove Grey</b> K93	LKB13093
● <b>Champagne</b> K95	LKB13095
● <b>White</b> K96	LKB13096
● <b>Light Grey</b> K97	LKB13097
● <b>Dark Grey</b> K99	LKB13099

<b>GRANITEX</b> NATURAL GRANITE EFFECT	Euro <b>546</b>
<b>METAL</b>	
● <b>Titanium</b> M73	LMB13073
● <b>Aluminium</b> M79	LMB13079

<b>MATT</b>	Euro <b>524</b>
● <b>Nero</b> G40	LGB13040
● <b>Tortora</b> G43	LGB13043
● <b>Cemento</b> G48	LGB13048
● <b>Bianco</b> G68	LGB13068
● <b>Espresso</b> G78	LGB13078

<b>CLASSIC</b>	Euro <b>524</b>
● <b>Avena</b> G51	LGB13051
● <b>Antracite</b> G59	LGB13059
● <b>Bianco Antico</b> G62	LGB13062

# BEST 130 BUNDLE



Light Grey  
K97

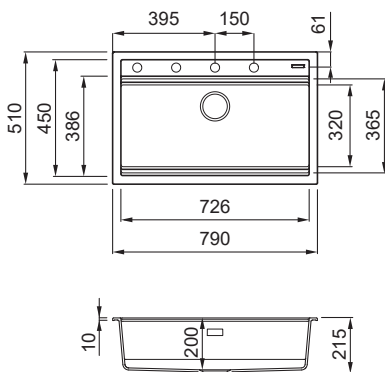

### Lavello 1 vasca con Flex Drainer e colander inclusi

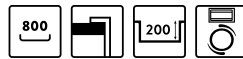

### CARATTERISTICHE

Dimensioni (mm) **790 x 510**  
 Base (mm) **800**  
 Foro da incasso (mm) **770 x 480**  
 Profondità Vasca (mm) **200**  
 Installazione **Sopratop**  
 Orientamento **Non reversibile**

### ACCESSORI CONSIGLIATI

93	97	25	50	163	164	5
75	71	9				

### MATERIALI E COLORI

<b>KERATEX</b> GERAM: NANOTECHNOLOGY ONE	Euro <b>828</b>
● <b>Black</b> K86	LKB13086K2
● <b>Dove Grey</b> K93	LKB13093K2
● <b>Champagne</b> K95	LKB13095K2
● <b>White</b> K96	LKB13096K2
● <b>Light Grey</b> K97	LKB13097K2
● <b>Dark Grey</b> K99	LKB13099K2

<b>GRANITEX</b> NATURAL GRANITE EFFECT	Euro <b>681</b>
<b>METAL</b>	
● <b>Titanium</b> M73	LMB13073K2
● <b>Aluminium</b> M79	LMB13079K2

<b>MATT</b>	Euro <b>657</b>
● <b>Nero</b> G40	LGB13040K2
● <b>Tortora</b> G43	LGB13043K2
● <b>Cemento</b> G48	LGB13048K2
● <b>Bianco</b> G68	LGB13068K2
● <b>Espresso</b> G78	LGB13078K2

<b>CLASSIC</b>	Euro <b>657</b>
● <b>Avena</b> G51	LGB13051K2
● <b>Antracite</b> G59	LGB13059K2
● <b>Bianco Antico</b> G62	LGB13062K2

# BEST 105 NEW



**Black**  
K86

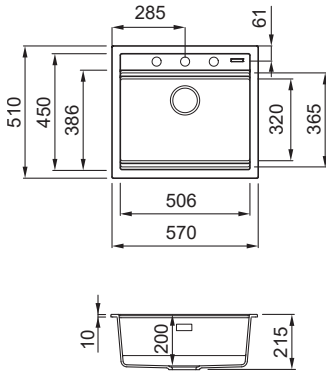

Lavello 1 vasca

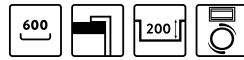

### CARATTERISTICHE

Dimensioni (mm)	<b>570 x 510</b>
Base (mm)	<b>600</b>
Foro da incasso (mm)	<b>550 x 480</b>
Profondità Vasca (mm)	<b>200</b>
Installazione	<b>Sopratop</b>
Orientamento	<b>Non reversibile</b>

### ACCESSORI CONSIGLIATI

93	97	25	50	153	156	163
164	5	75	71	9		

### MATERIALI E COLORI

<b>KERATEK</b> <small>CERAMIC NANOTECHNOLOGY DNE</small>	Euro <b>636</b>
<b>Black</b> K86	LKB10586
<b>Dove Grey</b> K93	LKB10593
<b>Champagne</b> K95	LKB10595
<b>White</b> K96	LKB10596
<b>Light Grey</b> K97	LKB10597
<b>Dark Grey</b> K99	LKB10599

<b>GRANITEK</b> <small>NATURAL GRANITE EFFECT</small>	Euro <b>502</b>
<b>METAL</b>	
<b>Titanium</b> M73	LMB10573
<b>Aluminium</b> M79	LMB10579

<b>MATT</b>	Euro <b>482</b>
<b>Nero</b> G40	LGB10540
<b>Tortora</b> G43	LGB10543
<b>Cemento</b> G48	LGB10548
<b>Bianco</b> G68	LGB10568
<b>Espresso</b> G78	LGB10578

<b>CLASSIC</b>	Euro <b>482</b>
<b>Avena</b> G51	LGB10551
<b>Antracite</b> G59	LGB10559
<b>Bianco Antico</b> G62	LGB10562

# BEST 104 NEW



**Black**  
K86

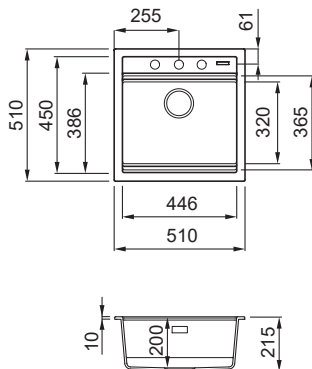

Lavello 1 vasca



### CARATTERISTICHE

Dimensioni (mm)	<b>510 x 510</b>
Base (mm)	<b>500     600 se inizio composizione</b>
Foro da incasso (mm)	<b>490 x 480</b>
Profondità Vasca (mm)	<b>200</b>
Installazione	<b>Sopratop</b>
Orientamento	<b>Non reversibile</b>

### ACCESSORI CONSIGLIATI

93	97	25	50	153	156	163
164	5	75	71	9		

### MATERIALI E COLORI

<b>KERATEK</b> <small>CERAMIC NANOTECHNOLOGY DNE</small>	Euro <b>636</b>
<b>Black</b> K86	LKB10486
<b>Dove Grey</b> K93	LKB10493
<b>Champagne</b> K95	LKB10495
<b>White</b> K96	LKB10496
<b>Light Grey</b> K97	LKB10497
<b>Dark Grey</b> K99	LKB10499

<b>GRANITEK</b> <small>NATURAL GRANITE EFFECT</small>	Euro <b>502</b>
<b>METAL</b>	
<b>Titanium</b> M73	LMB10473
<b>Aluminium</b> M79	LMB10479

<b>MATT</b>	Euro <b>482</b>
<b>Nero</b> G40	LGB10440
<b>Tortora</b> G43	LGB10443
<b>Cemento</b> G48	LGB10448
<b>Bianco</b> G68	LGB10468
<b>Espresso</b> G78	LGB10478

<b>CLASSIC</b>	Euro <b>482</b>
<b>Avena</b> G51	LGB10451
<b>Antracite</b> G59	LGB10459
<b>Bianco Antico</b> G62	LGB10462





MAGGIORI  
INFORMAZIONI  
LINEA ZEN



**LESS IS MORE**

Il design senza tempo per dirsi tale deve resistere alle mode passeggere e deve potersi armonizzare con un'ampia varietà di ambienti. Abbiamo sviluppato una nuova linea che sottolinea sia la tecnologia sia la cura dei dettagli di Elleci e che si distingue dalla concorrenza grazie alla propria versatilità di utilizzo. In una parola... ZEN

PLUS **ZEN**



ACCESSORI  
ELEMENT



FLOW PRO



SMART EDGE  
6 MM

**KERATEK**<sup>®</sup>  
CERAMIC NANOTECHNOLOGY CN6

-  **Black**  
K86
-  **Dove Grey**  
K93
-  **Champagne**  
K95
-  **White**  
K96
-  **Light Grey**  
K97
-  **Dark Grey**  
K99



## I MODELLI ZEN

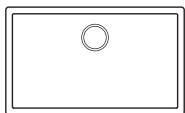

ZEN 130

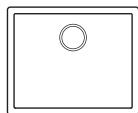

ZEN 105

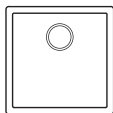

ZEN 102

**Corredo del lavello:** Sifone salvaspazio, piletta Flow Pro integrata, troppopieno rettangolare, ganci e kit montaggio Sottotop.

## ACCESSORI CONSIGLIATI

91

**ELEMENT  
TAGLIERE 420**  
ATH040OL  
Pag. 143



### Finiture



157

**ELEMENT DRAINER  
FLEX 440**  
ARS013BK  
Pag. 144

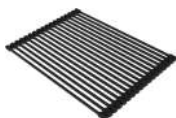

### Finiture



152

**ELEMENT  
COLANDER 418**  
AVP035BK  
Pag. 145



### Finiture



## IL PERFETTO MATCH MISCELATORI



**CLUB - Black BK**  
MOKCLUBK

Pag. 163

Disponibile nelle colorazioni



## OPTIONAL

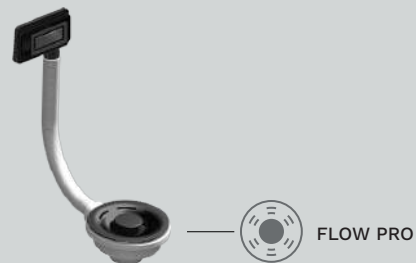

KIT ELEMENT  
**FLOW PRO + TROPPO PIENO BLACK**  
KITWPT-F-1VSL-L-BK

Pag. 146

## elleci | BEAUTY



Una linea di prodotti appositamente studiata per la cura dei lavelli in composito.

Scopri di più a pag. 200

\*Per ulteriori informazioni vai alla sezione accessori a pag. 140

# ZEN 130



Dark Grey  
K99

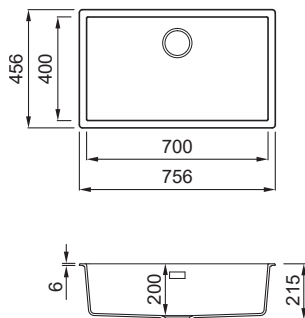

## OPTIONAL



Pag. 146

## MATERIALI E COLORI

KERATEX CERAMIC NANOTECHNOLOGY DNR		Euro 593
	<b>Black</b> K86	LKZ13086
	<b>Dove Grey</b> K93	LKZ13093
	<b>Champagne</b> K95	LKZ13095
	<b>White</b> K96	LKZ13096
	<b>Light Grey</b> K97	LKZ13097
	<b>Dark Grey</b> K99	LKZ13099

## Lavello 1 vasca



### CARATTERISTICHE

Dimensioni (mm)	<b>756 x 456</b>
Base (mm)	<b>800</b>
Foro da incasso (mm)	<b>745 x 445 R5 (Standard), 700 x 400 R10 (Sottotop)</b>
Profondità Vasca (mm)	<b>200</b>
Installazione	<b>Sopratop, Sottotop</b>
Orientamento	<b>Non reversibile</b>

### ACCESSORI CONSIGLIATI

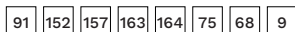

# ZEN 105



Dark Grey  
K99

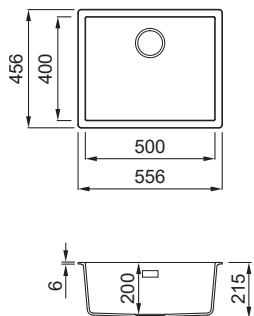

## Lavello 1 vasca



### CARATTERISTICHE

Dimensioni (mm)	<b>556 x 456</b>
Base (mm)	<b>600</b>
Foro da incasso (mm)	<b>545 x 445 R5 (Standard), 500 x 400 R10 (Sottotop)</b>
Profondità Vasca (mm)	<b>200</b>
Installazione	<b>Sopratop, Sottotop</b>
Orientamento	<b>Non reversibile</b>

### ACCESSORI CONSIGLIATI

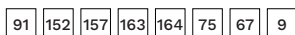

## MATERIALI E COLORI

KERATEX CERAMIC NANOTECHNOLOGY DNR		Euro 537
	<b>Black</b> K86	LKZ10586
	<b>Dove Grey</b> K93	LKZ10593
	<b>Champagne</b> K95	LKZ10595
	<b>White</b> K96	LKZ10596
	<b>Light Grey</b> K97	LKZ10597
	<b>Dark Grey</b> K99	LKZ10599

ZEN 102



Dark Grey  
K99

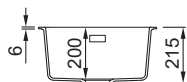
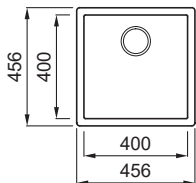

OPTIONAL



Pag. 146

MATERIALI E COLORI

KERATEX CERAMIC NANOTECHNOLOGY ONE		Euro 487
	<b>Black</b> K86	LKZ10286
	<b>Dove Grey</b> K93	LKZ10293
	<b>Champagne</b> K95	LKZ10295
	<b>White</b> K96	LKZ10296
	<b>Light Grey</b> K97	LKZ10297
	<b>Dark Grey</b> K99	LKZ10299

Lavello 1 vasca



CARATTERISTICHE

Dimensioni (mm)	<b>456 x 456</b>
Base (mm)	<b>450     500 se inizio composizione (Sopratop), 500 (Sottotop)</b>
Foro da incasso (mm)	<b>445 x 445 R5 (Standard), 400 x 400 R10 (Sottotop)</b>
Profondità Vasca (mm)	<b>200</b>
Installazione	<b>Sopratop, Sottotop</b>
Orientamento	<b>Non reversibile</b>

ACCESSORI CONSIGLIATI

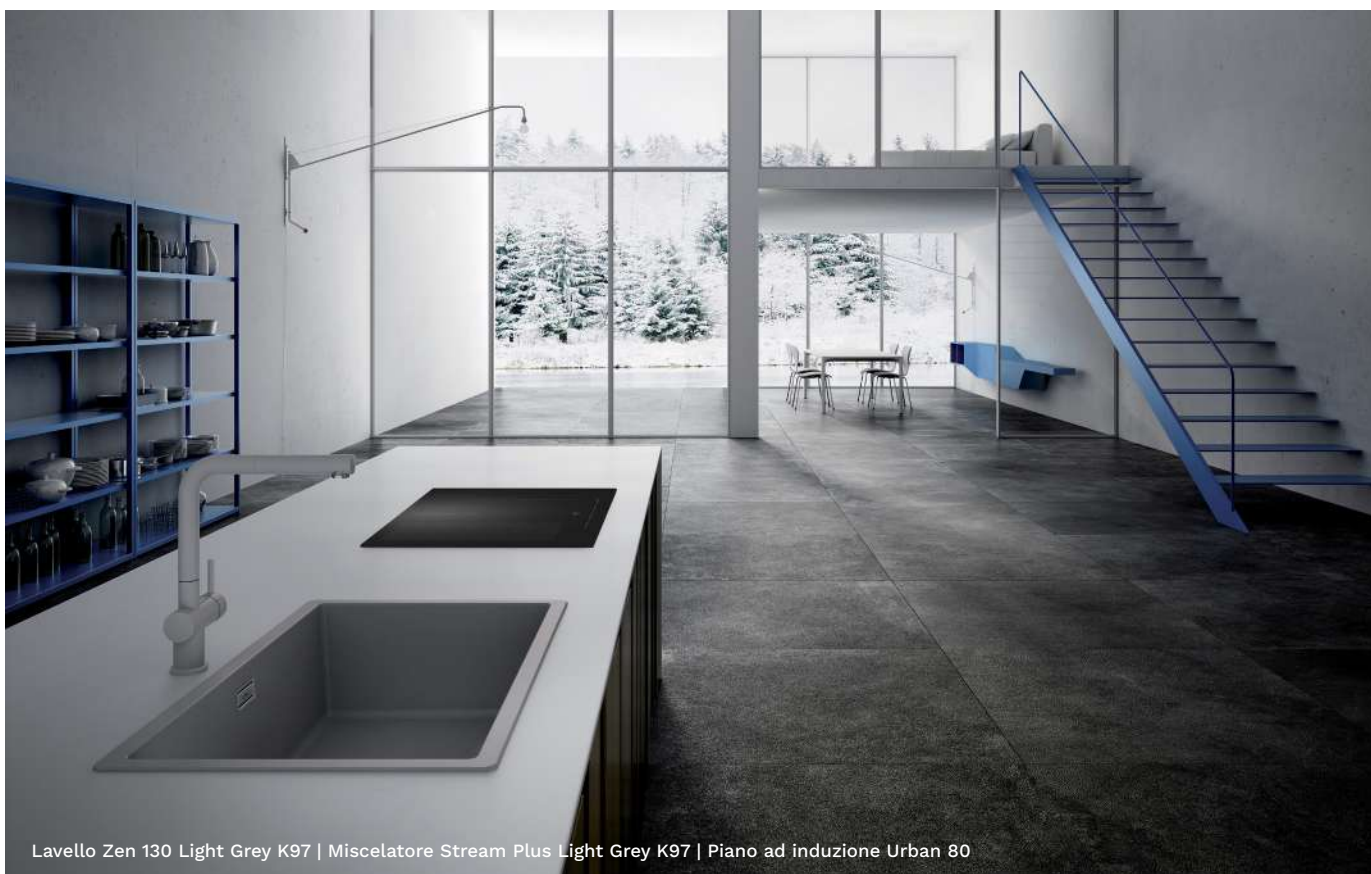
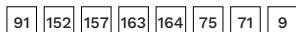

Lavello Zen 130 Light Grey K97 | Miscelatore Stream Plus Light Grey K97 | Piano ad induzione Urban 80



MAGGIORI  
INFORMAZIONI  
LINEA ZEN-F



#### ESTETICA SENZA INTERRUZIONI

Linee e forme in continuum sensoriale. Una linea di lavelli con installazione filo top che esalta la fluidità estetica tra piano e workstation. Un nome che si fa garante di relax, precisione e pulizia.

#### PLUS **ZEN-F**



ACCESSORI  
ELEMENT



FLOW PRO

**KERATEK**<sup>®</sup>  
CERAMIC NANOTECHNOLOGY CN6

-  **Black**  
K86
-  **Dove Grey**  
K93
-  **Champagne**  
K95
-  **White**  
K96
-  **Light Grey**  
K97
-  **Dark Grey**  
K99

## I MODELLI ZEN-F

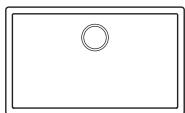

ZEN-F 130

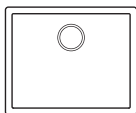

ZEN-F 105

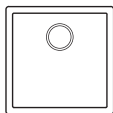

ZEN-F 102

**Corredo del lavello:** Sifone salvaspazio, piletta Flow Pro integrata, troppopieno rettangolare, ganci.

## ACCESSORI CONSIGLIATI

91

**ELEMENT  
TAGLIERE 420**  
ATH040OL  
Pag. 143



### Finiture

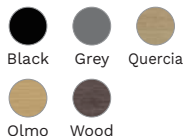

157

**ELEMENT DRAINER  
FLEX 440**  
ARS013BK  
Pag. 144

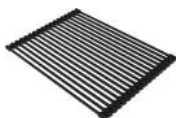

### Finiture



152

**ELEMENT  
COLANDER 418**  
AVP035BK  
Pag. 145



### Finiture



## IL PERFETTO MATCH MISCELATORI



**TEMA - Black K86**  
MKKTEM86

Pag. 156

Disponibile nelle colorazioni

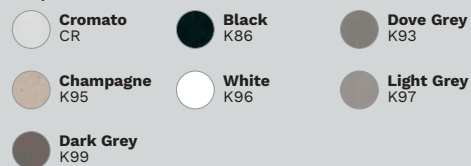

## OPTIONAL

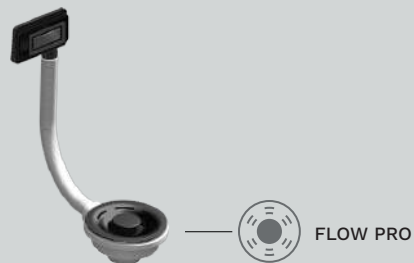

KIT ELEMENT  
**FLOW PRO + TROPPO PIENO BLACK**  
KITWPT-F-1VSL-L-BK

Pag. 146

## elleci | BEAUTY



Una linea di prodotti appositamente studiata per la cura dei lavelli in composito.

Scopri di più a pag. 200

\*Per ulteriori informazioni vai alla sezione accessori a pag. 140

## ZEN-F 130 NEW



### OPTIONAL



Pag. 146

**Black**  
K86

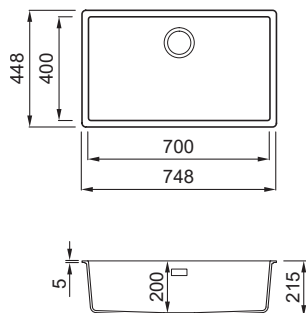

Lavello 1 vasca per installazione  
**Filotop**



### CARATTERISTICHE

Dimensioni (mm)	<b>748 x 448</b>
Base (mm)	<b>800</b>
Foro da incasso (mm)	<b>Da dima*</b>
Profondità Vasca (mm)	<b>200</b>
Installazione	<b>Filotop</b>
Orientamento	<b>Non reversibile</b>

\*dima inclusa nella confezione o scaricabile dalla sezione download specifica del sito [www.elleci.com/it](http://www.elleci.com/it)

## ZEN-F 105 NEW



**Black**  
K86

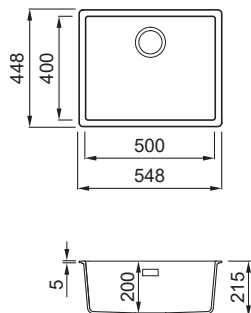

Lavello 1 vasca per installazione  
**Filotop**



### CARATTERISTICHE

Dimensioni (mm)	<b>548 x 448</b>
Base (mm)	<b>600</b>
Foro da incasso (mm)	<b>Da dima*</b>
Profondità Vasca (mm)	<b>200</b>
Installazione	<b>Filotop</b>
Orientamento	<b>Non reversibile</b>

\*dima inclusa nella confezione o scaricabile dalla sezione download specifica del sito [www.elleci.com/it](http://www.elleci.com/it)

### MATERIALI E COLORI

<b>KERATEK</b> <small>CERAMIC NANOTECHNOLOGY DNR</small>	Euro <b>628</b>
<b>Black</b> K86	LKZ13086F01
<b>Dove Grey</b> K93	LKZ13093F01
<b>Champagne</b> K95	LKZ13095F01
<b>White</b> K96	LKZ13096F01
<b>Light Grey</b> K97	LKZ13097F01
<b>Dark Grey</b> K99	LKZ13099F01

### MATERIALI E COLORI

<b>KERATEK</b> <small>CERAMIC NANOTECHNOLOGY DNR</small>	Euro <b>572</b>
<b>Black</b> K86	LKZ10586F01
<b>Dove Grey</b> K93	LKZ10593F01
<b>Champagne</b> K95	LKZ10595F01
<b>White</b> K96	LKZ10596F01
<b>Light Grey</b> K97	LKZ10597F01
<b>Dark Grey</b> K99	LKZ10599F01

ZEN-F 102 **NEW**



**Black**  
K86

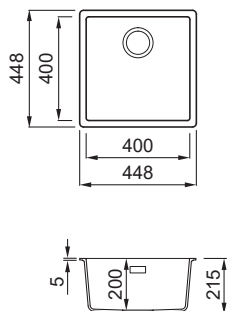

OPTIONAL



Pag. 146

MATERIALI E COLORI

KERATEX <small>CERAMIC NANOTECHNOLOGY ONE</small>		Euro 522
	<b>Black</b> K86	LKZ10286F01
	<b>Dove Grey</b> K93	LKZ10293F01
	<b>Champagne</b> K95	LKZ10295F01
	<b>White</b> K96	LKZ10296F01
	<b>Light Grey</b> K97	LKZ10297F01
	<b>Dark Grey</b> K99	LKZ10299F01

Lavello 1 vasca per installazione **Filotop**



**CARATTERISTICHE**

Dimensioni (mm)	<b>448 x 448</b>
Base (mm)	<b>500</b>
Foro da incasso (mm)	<b>Da dima*</b>
Profondità Vasca (mm)	<b>200</b>
Installazione	<b>Filotop</b>
Orientamento	<b>Non reversibile</b>

\*dima inclusa nella confezione o scaricabile dalla sezione download specifica del sito [www.elleci.com/it](http://www.elleci.com/it)



Lavello Zen F 105 Light Grey K97 | Miscelatore Wave Black BK



MAGGIORI  
INFORMAZIONI  
LINEA KARISMA



#### DESIGN CARISMATICO

Bordo "svasato" che invita ad un uso più armonioso del lavello. Pur mantenendo linee rette e decise, il design interviene per donare funzionalità e praticità. Lo smusso interno di 45°, che congiunge il bordo all'interno vasca, facilita le operazioni di PREPARING, CLEANING e COOKING nella Water Zone.

#### PLUS KARISMA



PILETTA  
QUADRATA



TROPPOPIENO  
RETTANGOLARE







AREA  
ACCESSORI  
INTEGRATA



BORDO K

**GRANITEK**<sup>®</sup>  
NATURAL GRANITE EFFECT

-  **Titanium**  
M73
-  **Aluminium**  
M79
-  **Nero**  
G40
-  **Tortora**  
G43
-  **Bianco**  
G68



## I MODELLI KARISMA

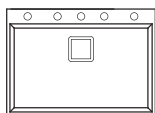

KARISMA 120 SOPRATOP

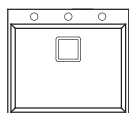

KARISMA 105 SOPRATOP

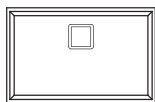

KARISMA 120 SOTTOTOP

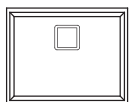

KARISMA 105 SOTTOTOP

**Corredo del lavello:** Sifone salvaspazio, piletta quadrata, troppopieno rettangolare e ganci.

## ACCESSORI CONSIGLIATI

88

### ELEMENT TAGLIERE SLIDING 50 CM

ATH010QU  
Pag. 142



#### Finiture

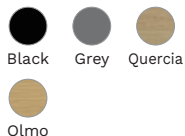

5

### COLANDER

AVI03001  
Pag. 150



157

### ELEMENT DRAINER FLEX 440

ARS013BK  
Pag. 144

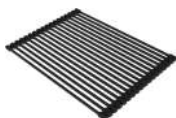

#### Finiture



75

### CESTELLO

ACI01307  
Pag. 151



\*Per ulteriori informazioni vai alla sezione accessori a pag. 140

## IL PERFETTO MATCH MISCELATORI



### TOURMALINE - Nero G40 MGKTOU40

Pag. 160

Disponibile nelle colorazioni

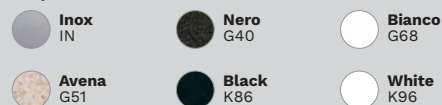

## OPTIONAL



KIT ELEMENT

### ELEMENT DISPENSER SAPONE QUADRATO ADI02301

Pag. 145

## elleci | BEAUTY



Una linea di prodotti appositamente studiata per la cura dei lavelli in composito.

Scopri di più a pag. 200

## KARISMA 120



Bianco  
G68

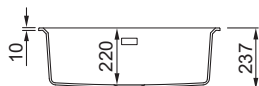
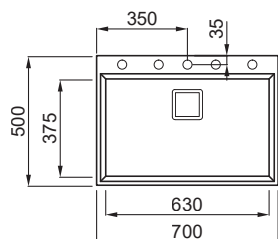

Lavello 1 vasca



### CARATTERISTICHE

Dimensioni (mm)	<b>700 x 500</b>
Base (mm)	<b>800</b>
Foro da incasso (mm)	<b>680 x 480</b>
Profondità Vasca (mm)	<b>220</b>
Installazione	<b>Sopratop</b>
Orientamento	<b>Non reversibile</b>

### ACCESSORI CONSIGLIATI



### MATERIALI E COLORI

METAL		<b>Titanium</b> M73	Euro <b>474</b> LMK12073
		<b>Aluminium</b> M79	LMK12079
MATT		<b>Nero</b> G40	Euro <b>447</b> LGK12040
		<b>Tortora</b> G43	LGK12043
		<b>Bianco</b> G68	LGK12068

## KARISMA 105



Bianco  
G68

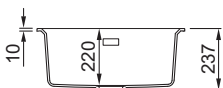
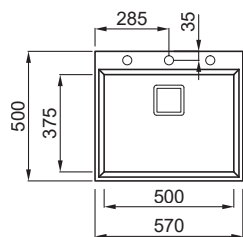

Lavello 1 vasca



### CARATTERISTICHE

Dimensioni (mm)	<b>570 x 500</b>
Base (mm)	<b>600</b>
Foro da incasso (mm)	<b>550 x 480</b>
Profondità Vasca (mm)	<b>220</b>
Installazione	<b>Sopratop</b>
Orientamento	<b>Non reversibile</b>

### ACCESSORI CONSIGLIATI

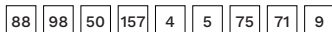

### MATERIALI E COLORI

METAL		<b>Titanium</b> M73	Euro <b>384</b> LMK10573
		<b>Aluminium</b> M79	LMK10579
MATT		<b>Nero</b> G40	Euro <b>364</b> LGK10540
		<b>Tortora</b> G43	LGK10543
		<b>Bianco</b> G68	LGK10568

## KARISMA 120 SOTTOTOP



Titanium  
M73

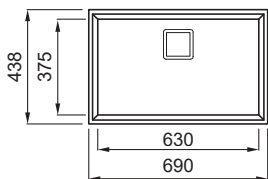

Lavello 1 vasca



### CARATTERISTICHE

Dimensioni (mm)	<b>690 x 438</b>
Base (mm)	<b>800</b>
Foro da incasso (mm)	<b>664 x 411 R5</b>
Profondità Vasca (mm)	<b>220</b>
Installazione	<b>Sottotop</b>
Orientamento	<b>Non reversibile</b>

### ACCESSORI CONSIGLIATI

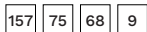

### MATERIALI E COLORI

**GRANITEK**  
NATURAL GRANITE EFFECT

METAL

- Titanium M73
- Aluminium M79

Euro **492**  
LMK12073BSO  
LMK12079BSO

MATT

- Nero G40
- Tortora G43
- Bianco G68

Euro **474**  
LGK12040BSO  
LGK12043BSO  
LGK12068BSO

## KARISMA 105 SOTTOTOP



Titanium  
M73

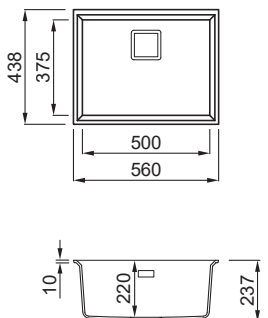

Lavello 1 vasca



### CARATTERISTICHE

Dimensioni (mm)	<b>560 x 438</b>
Base (mm)	<b>600</b>
Foro da incasso (mm)	<b>534 x 411 R5</b>
Profondità Vasca (mm)	<b>220</b>
Installazione	<b>Sottotop</b>
Orientamento	<b>Non reversibile</b>

### ACCESSORI CONSIGLIATI

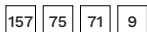

### MATERIALI E COLORI

**GRANITEK**  
NATURAL GRANITE EFFECT

METAL

- Titanium M73
- Aluminium M79

Euro **398**  
LMK10573BSO  
LMK10579BSO

MATT

- Nero G40
- Tortora G43
- Bianco G68

Euro **380**  
LGK10540BSO  
LGK10543BSO  
LGK10568BSO



MAGGIORI  
INFORMAZIONI  
LINEA INTEGRA



**DESIGN MODERNO CHE SVELA L'ECCELLENZA**

Una linea sottotop con la possibilità di integrazione con il piano lavoro. L'utilizzo di componenti come la nuova piletta FLOW PRO ed il troppopieno rettangolare contribuiscono a conferire a questa collezione un aspetto elegante dal design minimale.

PLUS **INTEGRA**



GIUNZIONE  
INVISIBILE



TROPPOPIENO  
RETTANGOLARE

**KERATEK**<sup>®</sup>  
CERAMIC NANOTECHNOLOGY CN6

● **Black**  
K86

● **Dove Grey**  
K93

● **White**  
K96

● **Dark Grey**  
K99

## I MODELLI INTEGRA

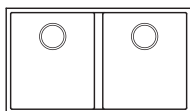

INTEGRA 350

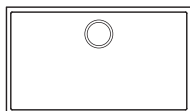

INTEGRA 130

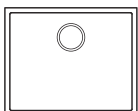

INTEGRA 105

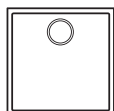

INTEGRA 102

**Corredo del lavello:** Sifone salvaspazio, piletta Flow Pro integrata e troppopieno rettangolare.

## ACCESSORI CONSIGLIATI

91

**ELEMENT  
TAGLIERE 420**  
ATH040OL  
Pag. 142



### Finiture

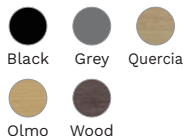

157

**ELEMENT DRAINER  
FLEX 440**  
ARS013BK  
Pag. 144

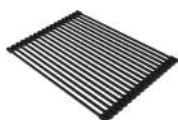

### Finiture



152

**ELEMENT  
COLANDER 418**  
AVP035BK  
Pag. 145



### Finiture



68

**BOTTOM GRID L**  
AGB01303  
Pag. 150

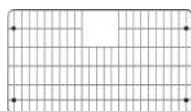

\*Per ulteriori informazioni vai alla sezione accessori a pag. 140

## IL PERFETTO MATCH MISCELATORI



**TRAIL - Nero G40**  
MGKTRA40

Pag. 159

Disponibile nelle colorazioni

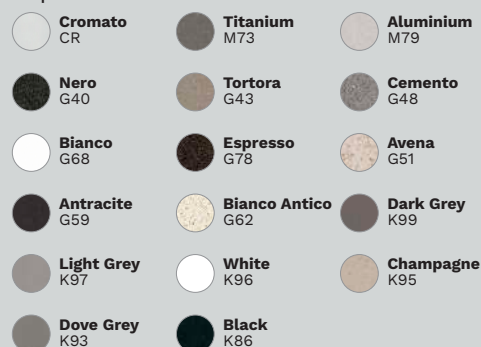

## OPTIONAL

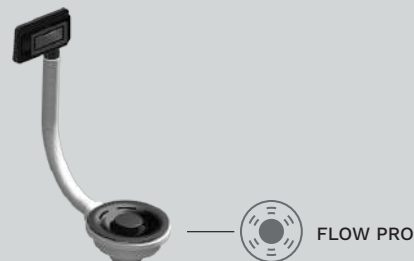

KIT ELEMENT  
**FLOW PRO + TROPPO PIENO BLACK**  
KITWPT-F-1VSL-L-BK

Pag. 146

## elleci | BEAUTY



Una linea di prodotti appositamente studiata per la cura dei lavelli in composito.

Scopri di più a pag. 200

# INTEGRA 350



## OPTIONAL



Pag. 146

White  
K96

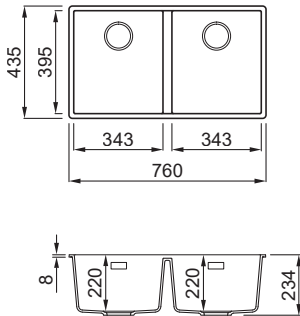

## Lavello 2 vasche



## CARATTERISTICHE

Dimensioni (mm)	<b>760 x 435</b>
Base (mm)	<b>800</b>
Foro da incasso (mm)	<b>720 x 395 R5</b>
Profondità Vasca 1 (mm)	<b>220</b>
Profondità Vasca 2 (mm)	<b>220</b>
Installazione	<b>Integrato e Sottotop</b>
Orientamento	<b>Non reversibile</b>

## ACCESSORI CONSIGLIATI

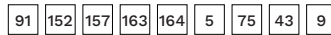

## MATERIALI E COLORI

**KERATEX**  
CERAMIC NANOTECHNOLOGY DNR

Euro **648**

	<b>Black</b> K86	LKQ35086BIN
	<b>Dove Grey</b> K93	LKQ35093BIN
	<b>White</b> K96	LKQ35096BIN
	<b>Dark Grey</b> K99	LKQ35099BIN

# INTEGRA 130



White  
K96

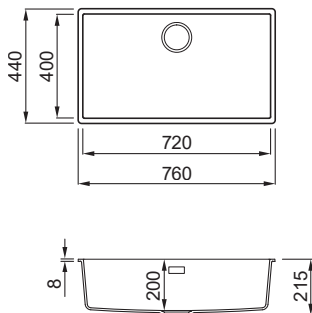

## Lavello 1 vasca



## CARATTERISTICHE

Dimensioni (mm)	<b>760 x 440</b>
Base (mm)	<b>800</b>
Foro da incasso (mm)	<b>720 x 400 R5</b>
Profondità Vasca (mm)	<b>200</b>
Installazione	<b>Integrato e Sottotop</b>
Orientamento	<b>Non reversibile</b>

## ACCESSORI CONSIGLIATI

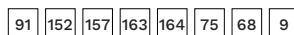

## MATERIALI E COLORI

**KERATEX**  
CERAMIC NANOTECHNOLOGY DNR

Euro **565**

	<b>Black</b> K86	LKQ13086BIN
	<b>Dove Grey</b> K93	LKQ13093BIN
	<b>White</b> K96	LKQ13096BIN
	<b>Dark Grey</b> K99	LKQ13099BIN

# INTEGRA 105



Dark Grey  
K99

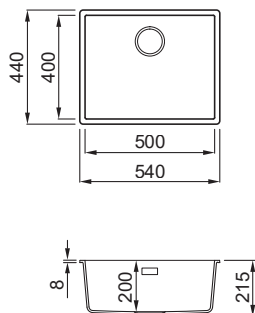

## OPTIONAL



Pag. 146

## MATERIALI E COLORI

KERATEX CERAMIC NANOTECHNOLOGY ONE		Euro 514
	<b>Black</b> K86	LKQ10586BIN
	<b>Dove Grey</b> K93	LKQ10593BIN
	<b>White</b> K96	LKQ10596BIN
	<b>Dark Grey</b> K99	LKQ10599BIN

## Lavello 1 vasca



## CARATTERISTICHE

Dimensioni (mm)	<b>540 x 440</b>
Base (mm)	<b>600</b>
Foro da incasso (mm)	<b>500 x 400 R5</b>
Profondità Vasca (mm)	<b>200</b>
Installazione	<b>Integrato e Sottotop</b>
Orientamento	<b>Non reversibile</b>

## ACCESSORI CONSIGLIATI

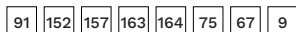

# INTEGRA 102 NEW



Dark Grey  
K99

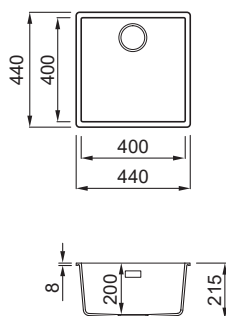

## Lavello 1 vasca



## CARATTERISTICHE

Dimensioni (mm)	<b>440 x 440</b>
Base (mm)	<b>500</b>
Foro da incasso (mm)	<b>400 x 400 R5</b>
Profondità Vasca (mm)	<b>200</b>
Installazione	<b>Integrato e Sottotop</b>
Orientamento	<b>Non reversibile</b>

## ACCESSORI CONSIGLIATI

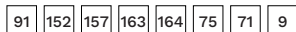

## MATERIALI E COLORI

KERATEX CERAMIC NANOTECHNOLOGY ONE		Euro 514
	<b>Black</b> K86	LKQ10286BIN
	<b>Dove Grey</b> K93	LKQ10293BIN
	<b>White</b> K96	LKQ10296BIN
	<b>Dark Grey</b> K99	LKQ10299BIN



MAGGIORI  
INFORMAZIONI  
LINEA QUADRA



**DESIGN MINIMAL E STILE CONTEMPORANEO**

Una collezione minimale che grazie alla sua semplicità riesce a mettere in risalto le linee moderne e pulite che la caratterizzano. Ogni modello è combinabile con numerosi accessori e molteplici colorazioni.

PLUS **QUADRA**





ACCESSORI  
ELEMENT



AREA  
ACCESSORI  
INTEGRATA

**GRANITEK**<sup>®</sup>  
NATURAL GRANITE EFFECT

-  **Titanium**  
M73
-  **Aluminium**  
M79
-  **Nero**  
G40
-  **Tortora**  
G43
-  **Cemento**  
G48
-  **Bianco**  
G68
-  **Espresso**  
G78

-  **Avena**  
G51
-  **Antracite**  
G59
-  **Bianco Antico**  
G62

**KERATEK**<sup>®</sup>  
CERAMIC NANOTECHNOLOGY CN6

-  **Black**  
K86
-  **Dove Grey**  
K93
-  **Champagne**  
K95
-  **White**  
K96
-  **Light Grey**  
K97
-  **Dark Grey**  
K99



## I MODELLI QUADRA

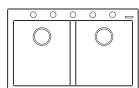

QUADRA 350

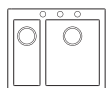

QUADRA 150

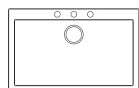

QUADRA 130

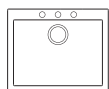

QUADRA 110

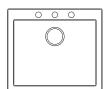

QUADRA 105



QUADRA 102



QUADRA 100



QUADRA 50

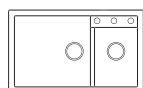

QUADRA 440

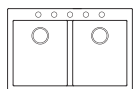

QUADRA 340

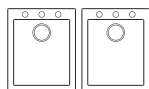

QUADRA 200

**Corredo del lavello:** Sifone salvaspazio, troppopieno tondo, pilette e ganci.

## ACCESSORI CONSIGLIATI

91

**ELEMENT  
TAGLIERE 420**  
ATH040OL  
Pag. 142



### Finiture



157

**ELEMENT DRAINER  
FLEX 440**  
ARS013BK  
Pag. 144

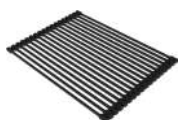

### Finiture



152

**ELEMENT  
COLANDER 418**  
AVP035BK  
Pag. 145



### Finiture



25

**ELEMENT DISPENSER  
SAPONE TONDO**  
ADI02300BK  
Pag. 145



### Finiture



## IL PERFETTO MATCH MISCELATORI



**TEMA - Black BK**  
MOKTEMBK

Pag. 156

Disponibile nelle colorazioni



## OPTIONAL



KIT ELEMENT  
**ELEMENT DISPENSER SAPONE TONDO**  
ADI02300

Pag. 145

## elleci | BEAUTY



Una linea di prodotti appositamente studiata per la cura dei lavelli in composito.

Scopri di più a pag. 200

\*Per ulteriori informazioni vai alla sezione accessori a pag. 140

## QUADRA 130



Bianco  
G68

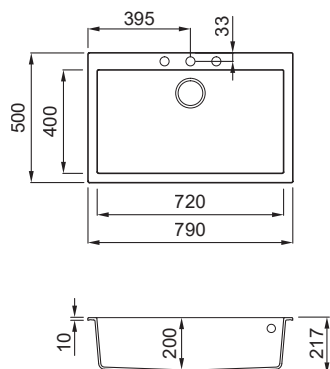

Lavello 1 vasca



### CARATTERISTICHE

Dimensioni (mm)	<b>790 x 500</b>
Base (mm)	<b>800</b>
Foro da incasso (mm)	<b>770 x 480</b>
Profondità Vasca (mm)	<b>200</b>
Installazione	<b>Sopratop</b>
Orientamento	<b>Non reversibile</b>

### ACCESSORI CONSIGLIATI

91	97	25	50	152	157	163
4	5	75	68	9		

### MATERIALI E COLORI

<b>KERATEK</b> GERMIC NANOTECHNOLOGY DNR	Euro <b>518</b>
<b>Black</b> K86	LKQ13086
<b>Dove Grey</b> K93	LKQ13093
<b>Champagne</b> K95	LKQ13095
<b>White</b> K96	LKQ13096
<b>Light Grey</b> K97	LKQ13097
<b>Dark Grey</b> K99	LKQ13099

<b>GRANITEK</b> NATURAL GRANITE EFFECT	Euro <b>418</b>
<b>METAL</b> <b>Titanium</b> M73	LMQ13073
<b>Aluminium</b> M79	LMQ13079

<b>MATT</b> <b>Nero</b> G40	Euro <b>394</b>	LGQ13040
<b>Tortora</b> G43	LGQ13043	
<b>Cemento</b> G48	LGQ13048	
<b>Bianco</b> G68	LGQ13068	
<b>Espresso</b> G78	LGQ13078	

<b>CLASSIC</b> <b>Avena</b> G51	Euro <b>394</b>	LGQ13051
<b>Antracite</b> G59	LGQ13059	
<b>Bianco Antico</b> G62	LGQ13062	

## QUADRA 110



Bianco  
G68

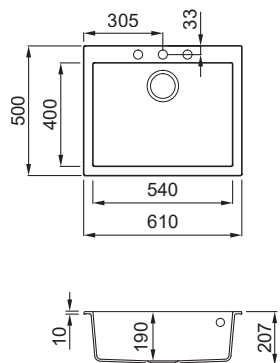

Lavello 1 vasca



### CARATTERISTICHE

Dimensioni (mm)	<b>610 x 500</b>
Base (mm)	<b>600     800 se inizio composizione</b>
Foro da incasso (mm)	<b>590 x 480</b>
Profondità Vasca (mm)	<b>190</b>
Installazione	<b>Sopratop</b>
Orientamento	<b>Non reversibile</b>

### ACCESSORI CONSIGLIATI

91	97	25	50	152	157	163
4	5	75	67	9		

### MATERIALI E COLORI

<b>KERATEK</b> GERMIC NANOTECHNOLOGY DNR	Euro <b>466</b>
<b>Black</b> K86	LKQ11086
<b>Dove Grey</b> K93	LKQ11093
<b>Champagne</b> K95	LKQ11095
<b>White</b> K96	LKQ11096
<b>Light Grey</b> K97	LKQ11097
<b>Dark Grey</b> K99	LKQ11099

<b>GRANITEK</b> NATURAL GRANITE EFFECT	Euro <b>382</b>
<b>METAL</b> <b>Titanium</b> M73	LMQ11073
<b>Aluminium</b> M79	LMQ11079

<b>MATT</b> <b>Nero</b> G40	Euro <b>357</b>	LGQ11040
<b>Tortora</b> G43	LGQ11043	
<b>Cemento</b> G48	LGQ11048	
<b>Bianco</b> G68	LGQ11068	
<b>Espresso</b> G78	LGQ11078	

<b>CLASSIC</b> <b>Avena</b> G51	Euro <b>357</b>	LGQ11051
<b>Antracite</b> G59	LGQ11059	
<b>Bianco Antico</b> G62	LGQ11062	

# QUADRA 105



Dark Grey  
K99

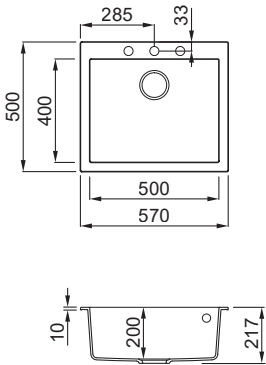

Lavello 1 vasca



### CARATTERISTICHE

Dimensioni (mm)	<b>570 x 500</b>
Base (mm)	<b>600</b>
Foro da incasso (mm)	<b>550 x 480</b>
Profondità Vasca (mm)	<b>200</b>
Installazione	<b>Sopratop</b>
Orientamento	<b>Non reversibile</b>

### ACCESSORI CONSIGLIATI



### MATERIALI E COLORI

<b>KERATEX</b> <small>CERAMIC NANOTECHNOLOGY ONE</small>	Euro <b>466</b>
<b>Black</b> K86	LKQ10586
<b>Dove Grey</b> K93	LKQ10593
<b>Champagne</b> K95	LKQ10595
<b>White</b> K96	LKQ10596
<b>Light Grey</b> K97	LKQ10597
<b>Dark Grey</b> K99	LKQ10599

<b>GRANITEK</b> <small>NATURAL GRANITE EFFECT</small>	Euro <b>382</b>
--	-----------------

METAL	<b>Titanium</b> M73	LMQ10573
	<b>Aluminium</b> M79	LMQ10579

MATT	<b>Nero</b> G40	LGQ10540
	<b>Tortora</b> G43	LGQ10543
	<b>Cemento</b> G48	LGQ10548
	<b>Bianco</b> G68	LGQ10568
	<b>Espresso</b> G78	LGQ10578

CLASSIC	Euro <b>357</b>	
	<b>Avena</b> G51	LGQ10551
	<b>Antracite</b> G59	LGQ10559
<b>Bianco Antico</b> G62	LGQ10562	

# QUADRA 102



Dark Grey  
K99

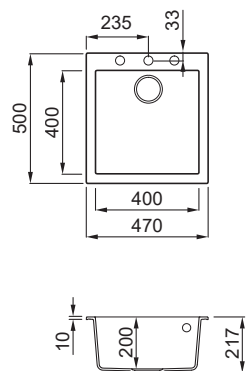

Lavello 1 vasca

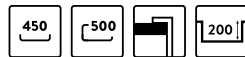

### CARATTERISTICHE

Dimensioni (mm)	<b>470 x 500</b>
Base (mm)	<b>450     500 se inizio composizione</b>
Foro da incasso (mm)	<b>450 x 480</b>
Profondità Vasca (mm)	<b>200</b>
Installazione	<b>Sopratop</b>
Orientamento	<b>Non reversibile</b>

### ACCESSORI CONSIGLIATI

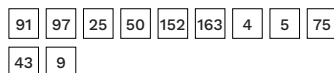

### MATERIALI E COLORI

<b>KERATEX</b> <small>CERAMIC NANOTECHNOLOGY ONE</small>	Euro <b>466</b>
<b>Black</b> K86	LKQ10286
<b>Dove Grey</b> K93	LKQ10293
<b>Champagne</b> K95	LKQ10295
<b>White</b> K96	LKQ10296
<b>Light Grey</b> K97	LKQ10297
<b>Dark Grey</b> K99	LKQ10299

<b>GRANITEK</b> <small>NATURAL GRANITE EFFECT</small>	Euro <b>382</b>
--	-----------------

METAL	<b>Titanium</b> M73	LMQ10273
	<b>Aluminium</b> M79	LMQ10279

MATT	Euro <b>357</b>	
	<b>Nero</b> G40	LGQ10240
	<b>Tortora</b> G43	LGQ10243
	<b>Cemento</b> G48	LGQ10248
	<b>Bianco</b> G68	LGQ10268
<b>Espresso</b> G78	LGQ10278	

CLASSIC	Euro <b>357</b>	
	<b>Avena</b> G51	LGQ10251
	<b>Antracite</b> G59	LGQ10259
<b>Bianco Antico</b> G62	LGQ10262	

# QUADRA 100



Nero G40

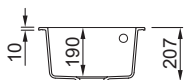
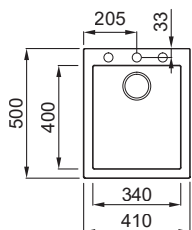

Lavello 1 vasca



## CARATTERISTICHE

Dimensioni (mm)	<b>410 x 500</b>
Base (mm)	<b>450</b>
Foro da incasso (mm)	<b>390 x 480</b>
Profondità Vasca (mm)	<b>190</b>
Installazione	<b>Sopratop</b>
Orientamento	<b>Non reversibile</b>

## ACCESSORI CONSIGLIATI

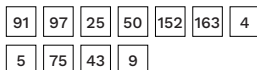

## MATERIALI E COLORI

<b>KERATEK</b> GERMIC NANOTECHNOLOGY DNE	Euro <b>373</b>
<b>Black</b> K86	LKQ10086
<b>Dove Grey</b> K93	LKQ10093
<b>Champagne</b> K95	LKQ10095
<b>White</b> K96	LKQ10096
<b>Light Grey</b> K97	LKQ10097
<b>Dark Grey</b> K99	LKQ10099

<b>GRANITEK</b> NATURAL GRANITE EFFECT	Euro <b>298</b>
<b>METAL</b>	
<b>Titanium</b> M73	LMQ10073
<b>Aluminium</b> M79	LMQ10079

<b>MATT</b>	Euro <b>281</b>
<b>Nero</b> G40	LGQ10040
<b>Tortora</b> G43	LGQ10043
<b>Cemento</b> G48	LGQ10048
<b>Bianco</b> G68	LGQ10068
<b>Espresso</b> G78	LGQ10078

<b>CLASSIC</b>	Euro <b>281</b>
<b>Avena</b> G51	LGQ10051
<b>Antracite</b> G59	LGQ10059
<b>Bianco Antico</b> G62	LGQ10062

# QUADRA 50



Nero G40

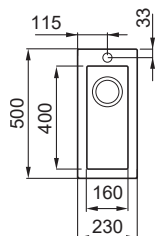

Lavello 1 vasca



## CARATTERISTICHE

Dimensioni (mm)	<b>230 x 500</b>
Base (mm)	<b>300</b>
Foro da incasso (mm)	<b>Da dima*</b>
Profondità Vasca (mm)	<b>155</b>
Installazione	<b>Sopratop</b>
Orientamento	<b>Non reversibile</b>

## ACCESSORI CONSIGLIATI



## MATERIALI E COLORI

<b>KERATEK</b> GERMIC NANOTECHNOLOGY DNE	Euro <b>308</b>
<b>Black</b> K86	LKQ05086
<b>Dove Grey</b> K93	LKQ05093
<b>Champagne</b> K95	LKQ05095
<b>White</b> K96	LKQ05096
<b>Light Grey</b> K97	LKQ05097
<b>Dark Grey</b> K99	LKQ05099

<b>GRANITEK</b> NATURAL GRANITE EFFECT	Euro <b>246</b>
<b>METAL</b>	
<b>Titanium</b> M73	LMQ05073
<b>Aluminium</b> M79	LMQ05079

<b>MATT</b>	Euro <b>235</b>
<b>Nero</b> G40	LGQ05040
<b>Tortora</b> G43	LGQ05043
<b>Cemento</b> G48	LGQ05048
<b>Bianco</b> G68	LGQ05068
<b>Espresso</b> G78	LGQ05078

<b>CLASSIC</b>	Euro <b>235</b>
<b>Avena</b> G51	LGQ05051
<b>Antracite</b> G59	LGQ05059
<b>Bianco Antico</b> G62	LGQ05062

\*dima inclusa nella confezione o scaricabile dalla sezione download specifica del sito [www.elleci.com/it](http://www.elleci.com/it)

## QUADRA 350



Bianco  
G68

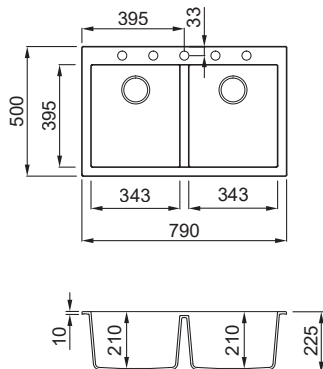

Lavello 2 vasche



### CARATTERISTICHE

Dimensioni (mm)	<b>790 x 500</b>
Base (mm)	<b>800</b>
Foro da incasso (mm)	<b>770 x 480</b>
Profondità Vasca 1 (mm)	<b>210</b>
Profondità Vasca 2 (mm)	<b>210</b>
Installazione	<b>Sopratop</b>
Orientamento	<b>Non reversibile</b>

### ACCESSORI CONSIGLIATI

91	96	25	50	152	157	163
4	5	75	43	9		

### MATERIALI E COLORI

<b>KERATEK</b> GERAMA NANOTECHNOLOGY ONE	Euro <b>593</b>
<b>Black</b> K86	LKQ35086
<b>Dove Grey</b> K93	LKQ35093
<b>Champagne</b> K95	LKQ35095
<b>White</b> K96	LKQ35096
<b>Light Grey</b> K97	LKQ35097
<b>Dark Grey</b> K99	LKQ35099

<b>GRANITEK</b> NATURAL GRANITE EFFECT	Euro <b>482</b>
<b>METAL</b>	
<b>Titanium</b> M73	LMQ35073
<b>Aluminium</b> M79	LMQ35079

<b>MATT</b>	Euro <b>451</b>
<b>Nero</b> G40	LGQ35040
<b>Tortora</b> G43	LGQ35043
<b>Cemento</b> G48	LGQ35048
<b>Bianco</b> G68	LGQ35068
<b>Espresso</b> G78	LGQ35078

<b>CLASSIC</b>	Euro <b>451</b>
<b>Avena</b> G51	LGQ35051
<b>Antracite</b> G59	LGQ35059
<b>Bianco Antico</b> G62	LGQ35062

## QUADRA 340



Bianco  
G68

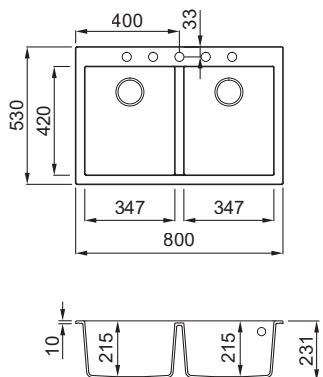

Lavello 2 vasche



### CARATTERISTICHE

Dimensioni (mm)	<b>800 x 530</b>
Base (mm)	<b>800     900 se inizio composizione</b>
Foro da incasso (mm)	<b>780 x 510</b>
Profondità Vasca 1 (mm)	<b>215</b>
Profondità Vasca 2 (mm)	<b>215</b>
Installazione	<b>Sopratop</b>
Orientamento	<b>Non reversibile</b>

### ACCESSORI CONSIGLIATI

96	25	50	156	163	5	75
43	9					

### MATERIALI E COLORI

<b>GRANITEK</b> NATURAL GRANITE EFFECT	Euro <b>528</b>
<b>METAL</b>	
<b>Titanium</b> M73	LMQ34073BTP
<b>Aluminium</b> M79	LMQ34079BTP
<b>MATT</b>	Euro <b>500</b>
<b>Nero</b> G40	LGQ34040BTP
<b>Tortora</b> G43	LGQ34043BTP
<b>Bianco</b> G68	LGQ34068BTP

<b>CLASSIC</b>	Euro <b>500</b>
<b>Avena</b> G51	LGQ34051BTP

# QUADRA 440

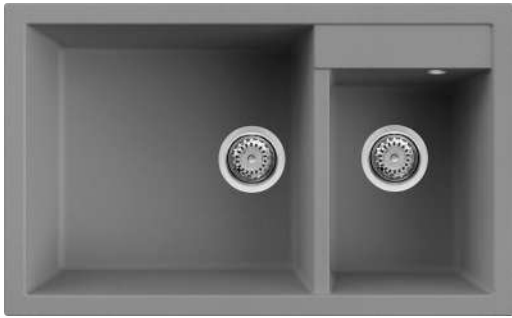

**Titanium**  
M73

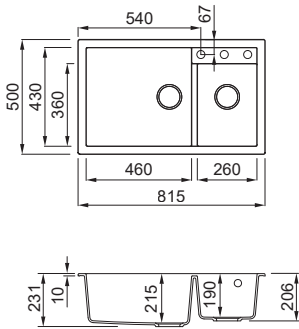

Lavello 2 vasche

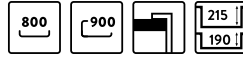

### CARATTERISTICHE

Dimensioni (mm) **815 x 500**  
 Base (mm) **800 ||| 900 se inizio composizione**  
 Foro da incasso (mm) **800 x 480**  
 Profondità Vasca 1 (mm) **215**  
 Profondità Vasca 2 (mm) **190**  
 Installazione **Sopratop**  
 Orientamento **Non reversibile**

### ACCESSORI CONSIGLIATI

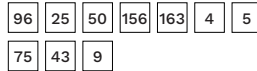

### MATERIALI E COLORI

		<b>GRANITEK</b> NATURAL GRANITE EFFECT	Euro <b>553</b>
METAL		<b>Titanium</b> M73	LMQ44073
		<b>Aluminium</b> M79	LMQ44079
			Euro <b>524</b>
MATT		<b>Nero</b> G40	LGQ44040
		<b>Tortora</b> G43	LGQ44043
		<b>Bianco</b> G68	LGQ44068
			Euro <b>524</b>
CLASSIC		<b>Avena</b> G51	LGQ44051

# QUADRA 150



**Titanium**  
M73

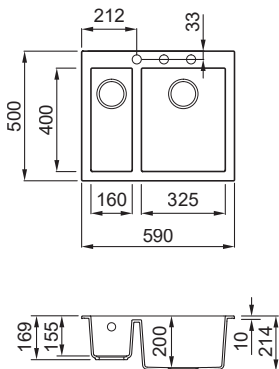

Lavello 2 vasche



### CARATTERISTICHE

Dimensioni (mm) **590 x 500**  
 Base (mm) **600**  
 Foro da incasso (mm) **570 x 480**  
 Profondità Vasca 1 (mm) **200**  
 Profondità Vasca 2 (mm) **155**  
 Installazione **Sopratop**  
 Orientamento **Non reversibile**

### ACCESSORI CONSIGLIATI

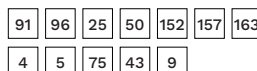

### MATERIALI E COLORI

		<b>KERATEK</b> CERAMIC NANOTECHNOLOGY ONE	Euro <b>518</b>
METAL		<b>Black</b> K86	LKQ15086
		<b>Dove Grey</b> K93	LKQ15093
		<b>Champagne</b> K95	LKQ15095
		<b>White</b> K96	LKQ15096
		<b>Light Grey</b> K97	LKQ15097
		<b>Dark Grey</b> K99	LKQ15099
METAL		<b>Titanium</b> M73	LMQ15073
		<b>Aluminium</b> M79	LMQ15079
			Euro <b>394</b>
MATT		<b>Nero</b> G40	LGQ15040
		<b>Tortora</b> G43	LGQ15043
		<b>Cemento</b> G48	LGQ15048
		<b>Bianco</b> G68	LGQ15068
		<b>Espresso</b> G78	LGQ15078
			Euro <b>394</b>
CLASSIC		<b>Avena</b> G51	LGQ15051
		<b>Antracite</b> G59	LGQ15059
		<b>Bianco Antico</b> G62	LGQ15062

# QUADRA 200



Nero G40

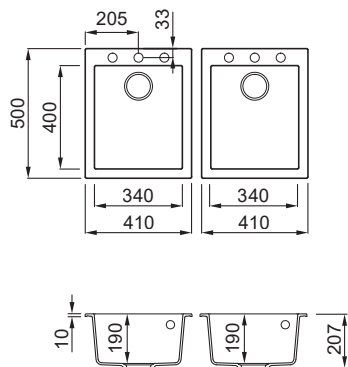

## Lavello 2 vasche



### CARATTERISTICHE

Dimensioni (mm) **410 x 500 + 410 x 500**  
 Base (mm) **900**  
 Foro da incasso (mm) **390 x 480 + 390 x 480**  
 (distanza min 50 mm, max 150 mm)  
 Profondità Vasca 1 (mm) **190**  
 Profondità Vasca 2 (mm) **190**  
 Installazione **Sopratop**  
 Orientamento **Non reversibile**

### ACCESSORI CONSIGLIATI

91	97	25	50	152	157	163
4	5	75	43	9		

## MATERIALI E COLORI

KERATEK CERAMIC NANOTECHNOLOGY ONE		Euro 668
● Black K86		LKQ20086
● Dove Grey K93		LKQ20093
● Champagne K95		LKQ20095
● White K96		LKQ20096
● Light Grey K97		LKQ20097
● Dark Grey K99		LKQ20099

GRANITEK NATURAL GRANITE EFFECT		Euro 533
METAL ● Titanium M73		LMQ20073
METAL ● Aluminium M79		LMQ20079
Euro 512		
MATT ● Nero G40		LGQ20040
MATT ● Tortora G43		LGQ20043
MATT ● Cemento G48		LGQ20048
MATT ● Bianco G68		LGQ20068
MATT ● Espresso G78		LGQ20078
Euro 512		
CLASSIC ● Avena G51		LGQ20051
CLASSIC ● Antracite G59		LGQ20059
CLASSIC ● Bianco Antico G62		LGQ20062



Lavello Quadra 130 Titanium M73 | Miscelatore Tema Black K86

COLLEZIONE  
**QUADRA SOTTOTOP**



MAGGIORI  
INFORMAZIONI  
LINEA QUADRA SOTTOTOP



**QUANDO LA CREATIVITÀ SI TRASFORMA IN FUNZIONALITÀ**

Questa collezione è stata pensata per ottimizzare al massimo l'incasso del lavello per raggiungere una totale pulizia del top da cucina.

PLUS **QUADRA**  
**SOTTOTOP**



ACCESSORI  
ELEMENT



INSTALLAZIONE  
MIXER SU TOP



OPTIONAL  
ELEMENT  
COVER  
MATERICA

**GRANITEK**<sup>®</sup>  
NATURAL GRANITE EFFECT

-  **Titanium**  
M73
-  **Aluminium**  
M79
-  **Nero**  
G40
-  **Tortora**  
G43
-  **Cemento**  
G48
-  **Bianco**  
G68
-  **Espresso**  
G78

-  **Avena**  
G51
-  **Antracite**  
G59
-  **Bianco Antico**  
G62

**KERATEK**<sup>®</sup>  
CERAMIC NANOTECHNOLOGY CN6

-  **Black**  
K86
-  **Dove Grey**  
K93
-  **Champagne**  
K95
-  **White**  
K96
-  **Light Grey**  
K97
-  **Dark Grey**  
K99



## I MODELLI QUADRA SOTTOTOP

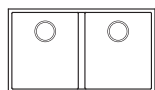

QUADRA 350

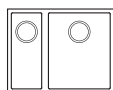

QUADRA 150

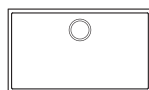

QUADRA 130

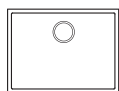

QUADRA 110

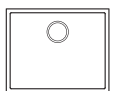

QUADRA 105



QUADRA 102



QUADRA 100



QUADRA 50

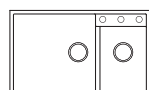

QUADRA 440

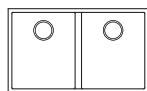

QUADRA 340

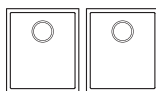

QUADRA 200

**Corredo del lavello:** Sifone salvaspazio, troppopieno tondo, pilette e ganci.

## ACCESSORI CONSIGLIATI

157

**ELEMENT DRAINER  
FLEX 440**  
ARS013BK  
Pag. 144

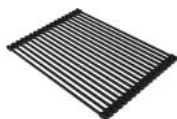

**Finiture**



Black

152

**ELEMENT  
COLANDER 418**  
AVP035BK  
Pag. 145



**Finiture**



Black

75

**CESTELLO**

ACI01307  
Pag. 151



68

**BOTTOM GRID L**

AGB01303  
Pag. 150

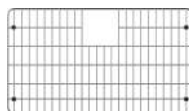

\*Per ulteriori informazioni vai alla sezione accessori a pag. 140

## IL PERFETTO MATCH MISCELATORI



**ADIGE - Inox IN  
MİKADIIN**

Pag. 162

Disponibile nelle colorazioni



Inox  
IN



Nero  
G40



Bianco  
G68



Black  
K86



White  
K96

## OPTIONAL



**KIT ELEMENT  
ELEMENT DISPENSER SAPONE TONDO**  
ADIO2300

Pag. 145

## elleci | BEAUTY



Una linea di prodotti appositamente studiata per la cura dei lavelli in composito.

Scopri di più a pag. 200

## QUADRA 130 SOTTOTOP



White  
K96

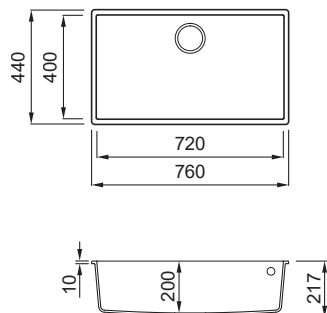

Lavello 1 vasca



### CARATTERISTICHE

Dimensioni (mm) **760 x 440**  
 Base (mm) **800**  
 Foro da incasso (mm) **720 x 400 R5**  
 Profondità Vasca (mm) **200**  
 Installazione **Sottotop**  
 Orientamento **Non reversibile**

### ACCESSORI CONSIGLIATI

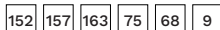

### MATERIALI E COLORI

KERATEK GERMIC NANOTECHNOLOGY DNE		Euro <b>538</b>
	<b>Black</b> K86	LKQ13086BSO
	<b>Dove Grey</b> K93	LKQ13093BSO
	<b>Champagne</b> K95	LKQ13095BSO
	<b>White</b> K96	LKQ13096BSO
	<b>Light Grey</b> K97	LKQ13097BSO
	<b>Dark Grey</b> K99	LKQ13099BSO

GRANITEK NATURAL GRANITE EFFECT		Euro <b>440</b>
	<b>Titanium</b> M73	LMQ13073BSO
	<b>Aluminium</b> M79	LMQ13079BSO

MATT		Euro <b>418</b>
	<b>Nero</b> G40	LGQ13040BSO
	<b>Tortora</b> G43	LGQ13043BSO
	<b>Cemento</b> G48	LGQ13048BSO
	<b>Bianco</b> G68	LGQ13068BSO
	<b>Espresso</b> G78	LGQ13078BSO

CLASSIC		Euro <b>418</b>
	<b>Avena</b> G51	LGQ13051BSO
	<b>Antracite</b> G59	LGQ13059BSO
	<b>Bianco Antico</b> G62	LGQ13062BSO

## QUADRA 110 SOTTOTOP



White  
K96

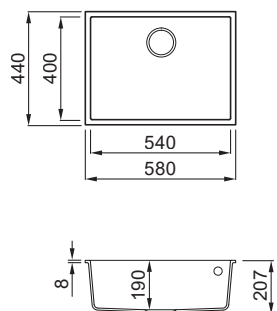

Lavello 1 vasca



### CARATTERISTICHE

Dimensioni (mm) **580 x 440**  
 Base (mm) **800**  
 Foro da incasso (mm) **540 x 400 R5**  
 Profondità Vasca (mm) **190**  
 Installazione **Sottotop**  
 Orientamento **Non reversibile**

### ACCESSORI CONSIGLIATI

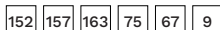

### MATERIALI E COLORI

KERATEK GERMIC NANOTECHNOLOGY DNE		Euro <b>490</b>
	<b>Black</b> K86	LKQ11086BSO
	<b>Dove Grey</b> K93	LKQ11093BSO
	<b>Champagne</b> K95	LKQ11095BSO
	<b>White</b> K96	LKQ11096BSO
	<b>Light Grey</b> K97	LKQ11097BSO
	<b>Dark Grey</b> K99	LKQ11099BSO

GRANITEK NATURAL GRANITE EFFECT		Euro <b>406</b>
	<b>Titanium</b> M73	LMQ11073BSO
	<b>Aluminium</b> M79	LMQ11079BSO

MATT		Euro <b>382</b>
	<b>Nero</b> G40	LGQ11040BSO
	<b>Tortora</b> G43	LGQ11043BSO
	<b>Cemento</b> G48	LGQ11048BSO
	<b>Bianco</b> G68	LGQ11068BSO
	<b>Espresso</b> G78	LGQ11078BSO

CLASSIC		Euro <b>382</b>
	<b>Avena</b> G51	LGQ11051BSO
	<b>Antracite</b> G59	LGQ11059BSO
	<b>Bianco Antico</b> G62	LGQ11062BSO

## QUADRA 105 SOTTOTOP



Tortora  
G43

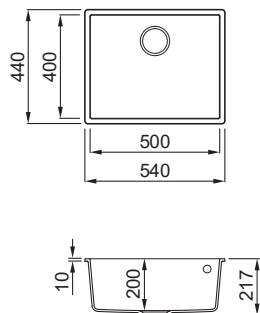

Lavello 1 vasca



### CARATTERISTICHE

Dimensioni (mm) **540 x 440**  
 Base (mm) **600**  
 Foro da incasso (mm) **500 x 400 R5**  
 Profondità Vasca (mm) **200**  
 Installazione **Sottotop**  
 Orientamento **Non reversibile**

### ACCESSORI CONSIGLIATI

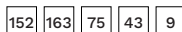

### MATERIALI E COLORI

KERATEX GERAM: NANOTECHNOLOGY ONE		Euro 490
● Black K86		LKQ10586BSO
● Dove Grey K93		LKQ10593BSO
● Champagne K95		LKQ10595BSO
● White K96		LKQ10596BSO
● Light Grey K97		LKQ10597BSO
● Dark Grey K99		LKQ10599BSO

### GRANITEK NATURAL GRANITE EFFECT

GRANITEK NATURAL GRANITE EFFECT		Euro 406
METAL ● Titanium M73		LMQ10573BSO
● Aluminium M79		LMQ10579BSO

MATT		Euro 382
● Nero G40		LGQ10540BSO
● Tortora G43		LGQ10543BSO
● Cemento G48		LGQ10548BSO
● Bianco G68		LGQ10568BSO
● Espresso G78		LGQ10578BSO

CLASSIC		Euro 382
● Avena G51		LGQ10551BSO
● Antracite G59		LGQ10559BSO
● Bianco Antico G62		LGQ10562BSO

## QUADRA 102 SOTTOTOP



Tortora  
G43

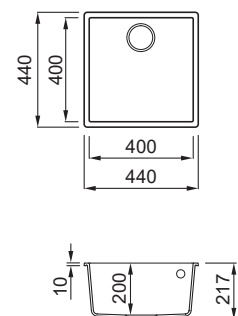

Lavello 1 vasca



### CARATTERISTICHE

Dimensioni (mm) **440 x 440**  
 Base (mm) **500**  
 Foro da incasso (mm) **400 x 400 R5**  
 Profondità Vasca (mm) **200**  
 Installazione **Sottotop**  
 Orientamento **Non reversibile**

### ACCESSORI CONSIGLIATI

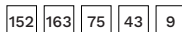

### MATERIALI E COLORI

KERATEX GERAM: NANOTECHNOLOGY ONE		Euro 490
● Black K86		LKQ10286BSO
● Dove Grey K93		LKQ10293BSO
● Champagne K95		LKQ10295BSO
● White K96		LKQ10296BSO
● Light Grey K97		LKQ10297BSO
● Dark Grey K99		LKQ10299BSO

### GRANITEK NATURAL GRANITE EFFECT

GRANITEK NATURAL GRANITE EFFECT		Euro 406
METAL ● Titanium M73		LMQ10273BSO
● Aluminium M79		LMQ10279BSO

MATT		Euro 382
● Nero G40		LGQ10240BSO
● Tortora G43		LGQ10243BSO
● Cemento G48		LGQ10248BSO
● Bianco G68		LGQ10268BSO
● Espresso G78		LGQ10278BSO

CLASSIC		Euro 382
● Avena G51		LGQ10251BSO
● Antracite G59		LGQ10259BSO
● Bianco Antico G62		LGQ10262BSO

## QUADRA 100 SOTTOTOP



Bianco  
G68

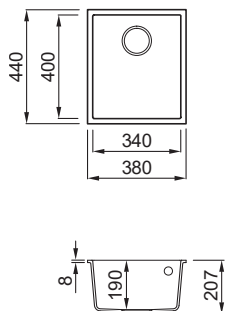

Lavello 1 vasca



### CARATTERISTICHE

Dimensioni (mm) **380 x 440**  
 Base (mm) **450**  
 Foro da incasso (mm) **340 x 400 R5**  
 Profondità Vasca (mm) **190**  
 Installazione **Sottotop**  
 Orientamento **Non reversibile**

### ACCESSORI CONSIGLIATI

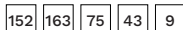

### MATERIALI E COLORI

KERATEK GERMIC NANOTECHNOLOGY DNR		Euro <b>391</b>
	<b>Black</b> K86	LKQ10086BSO
	<b>Dove Grey</b> K93	LKQ10093BSO
	<b>Champagne</b> K95	LKQ10095BSO
	<b>White</b> K96	LKQ10096BSO
	<b>Light Grey</b> K97	LKQ10097BSO
	<b>Dark Grey</b> K99	LKQ10099BSO

GRANITEK NATURAL GRANITE EFFECT		Euro <b>320</b>
<b>METAL</b>	<b>Titanium</b> M73	LMQ10073BSO
	<b>Aluminium</b> M79	LMQ10079BSO

		Euro <b>308</b>
<b>MATT</b>	<b>Nero</b> G40	LGQ10040BSO
	<b>Tortora</b> G43	LGQ10043BSO
	<b>Cemento</b> G48	LGQ10048BSO
	<b>Bianco</b> G68	LGQ10068BSO
	<b>Espresso</b> G78	LGQ10078BSO

		Euro <b>308</b>
<b>CLASSIC</b>	<b>Avena</b> G51	LGQ10051BSO
	<b>Antracite</b> G59	LGQ10059BSO
	<b>Bianco Antico</b> G62	LGQ10062BSO

## QUADRA 50 SOTTOTOP



Bianco  
G68

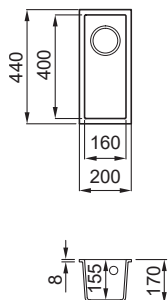

Lavello 1 vasca



### CARATTERISTICHE

Dimensioni (mm) **200 x 440**  
 Base (mm) **300**  
 Foro da incasso (mm) **160 x 400 R5**  
 Profondità Vasca (mm) **155**  
 Installazione **Sottotop**  
 Orientamento **Non reversibile**

### ACCESSORI CONSIGLIATI



### MATERIALI E COLORI

KERATEK GERMIC NANOTECHNOLOGY DNR		Euro <b>328</b>
	<b>Black</b> K86	LKQ05086BSO
	<b>Dove Grey</b> K93	LKQ05093BSO
	<b>Champagne</b> K95	LKQ05095BSO
	<b>White</b> K96	LKQ05096BSO
	<b>Light Grey</b> K97	LKQ05097BSO
	<b>Dark Grey</b> K99	LKQ05099BSO

GRANITEK NATURAL GRANITE EFFECT		Euro <b>271</b>
<b>METAL</b>	<b>Titanium</b> M73	LMQ05073BSO
	<b>Aluminium</b> M79	LMQ05079BSO

		Euro <b>258</b>
<b>MATT</b>	<b>Nero</b> G40	LGQ05040BSO
	<b>Tortora</b> G43	LGQ05043BSO
	<b>Cemento</b> G48	LGQ05048BSO
	<b>Bianco</b> G68	LGQ05068BSO
	<b>Espresso</b> G78	LGQ05078BSO

		Euro <b>258</b>
<b>CLASSIC</b>	<b>Avena</b> G51	LGQ05051BSO
	<b>Antracite</b> G59	LGQ05059BSO
	<b>Bianco Antico</b> G62	LGQ05062BSO

## QUADRA 350 SOTTOTOP



Tortora  
G43

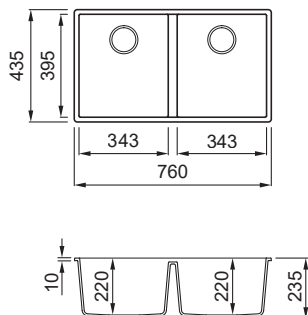

Lavello 2 vasche



### CARATTERISTICHE

Dimensioni (mm) **760 x 435**  
 Base (mm) **800**  
 Foro da incasso (mm) **720 x 395 R5**  
 Profondità Vasca 1 (mm) **220**  
 Profondità Vasca 2 (mm) **220**  
 Installazione **Sottotop**  
 Orientamento **Non reversibile**

### ACCESSORI CONSIGLIATI

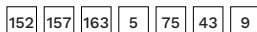

### MATERIALI E COLORI

KERATEK GERAM. NANOTECHNOLOGY ONE		Euro 618
● Black K86		LKQ35086BSO
● Dove Grey K93		LKQ35093BSO
● Champagne K95		LKQ35095BSO
● White K96		LKQ35096BSO
● Light Grey K97		LKQ35097BSO
● Dark Grey K99		LKQ35099BSO

GRANITEK NATURAL GRANITE EFFECT		Euro 516
METAL ● Titanium M73		LMQ35073BSO
METAL ● Aluminium M79		LMQ35079BSO

MATT		Euro 485
● Nero G40		LGQ35040BSO
● Tortora G43		LGQ35043BSO
● Cemento G48		LGQ35048BSO
● Bianco G68		LGQ35068BSO
● Espresso G78		LGQ35078BSO

CLASSIC		Euro 485
● Avena G51		LGQ35051BSO
● Antracite G59		LGQ35059BSO
● Bianco Antico G62		LGQ35062BSO

## QUADRA 340 SOTTOTOP



Tortora  
G43

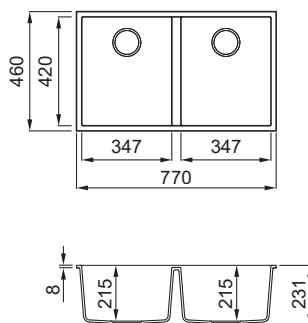

Lavello 2 vasche



### CARATTERISTICHE

Dimensioni (mm) **770 x 460**  
 Base (mm) **900**  
 Foro da incasso (mm) **730 x 420 R5**  
 Profondità Vasca 1 (mm) **215**  
 Profondità Vasca 2 (mm) **215**  
 Installazione **Sottotop**  
 Orientamento **Non reversibile**

### ACCESSORI CONSIGLIATI



### MATERIALI E COLORI

GRANITEK NATURAL GRANITE EFFECT		Euro 565
METAL ● Titanium M73		LMQ34073BSC
METAL ● Aluminium M79		LMQ34079BSC

MATT		Euro 535
● Nero G40		LGQ34040BSC
● Tortora G43		LGQ34043BSC
● Bianco G68		LGQ34068BSC

CLASSIC		Euro 535
● Avena G51		LGQ34051BSC

## QUADRA 440 SOTTOTOP



Bianco  
G68

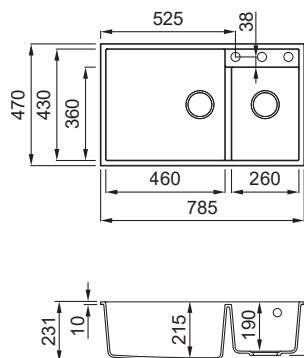

Lavello 2 vasche



### CARATTERISTICHE

Dimensioni (mm)	<b>785 x 470</b>
Base (mm)	<b>900</b>
Foro da incasso (mm)	<b>745 x 430 R5</b>
Profondità Vasca 1 (mm)	<b>215</b>
Profondità Vasca 2 (mm)	<b>190</b>
Installazione	<b>Sottotop</b>
Orientamento	<b>Non reversibile</b>

### ACCESSORI CONSIGLIATI

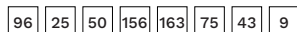

### MATERIALI E COLORI

<b>GRANITEK</b> NATURAL GRANITE EFFECT		Euro <b>596</b>
METAL	<b>Titanium</b> M73	LMQ44073BSO
	<b>Aluminium</b> M79	LMQ44079BSO
Euro <b>560</b>		
MATT	<b>Nero</b> G40	LGQ44040BSO
	<b>Tortora</b> G43	LGQ44043BSO
	<b>Bianco</b> G68	LGQ44068BSO
Euro <b>560</b>		
CLASSIC	<b>Avena</b> G51	LGQ44051BSO

## QUADRA 150 SOTTOTOP



Bianco  
G68

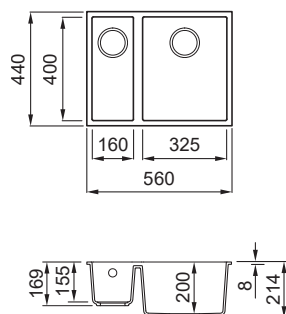

Lavello 2 vasche



### CARATTERISTICHE

Dimensioni (mm)	<b>560 x 440</b>
Base (mm)	<b>600</b>
Foro da incasso (mm)	<b>520 x 400 R5</b>
Profondità Vasca 1 (mm)	<b>200</b>
Profondità Vasca 2 (mm)	<b>155</b>
Installazione	<b>Sottotop</b>
Orientamento	<b>Non reversibile</b>

### ACCESSORI CONSIGLIATI



### MATERIALI E COLORI

<b>KERATEX</b> CERAMIC NANOTECHNOLOGY ONE		Euro <b>538</b>
METAL	<b>Black</b> K86	LKQ15086BSO
	<b>Dove Grey</b> K93	LKQ15093BSO
	<b>Champagne</b> K95	LKQ15095BSO
	<b>White</b> K96	LKQ15096BSO
	<b>Light Grey</b> K97	LKQ15097BSO
	<b>Dark Grey</b> K99	LKQ15099BSO
	Euro <b>440</b>	
MATT	<b>Titanium</b> M73	LMQ15073BSO
	<b>Aluminium</b> M79	LMQ15079BSO
Euro <b>418</b>		
MATT	<b>Nero</b> G40	LGQ15040BSO
	<b>Tortora</b> G43	LGQ15043BSO
	<b>Cemento</b> G48	LGQ15048BSO
	<b>Bianco</b> G68	LGQ15068BSO
	<b>Espresso</b> G78	LGQ15078BSO
Euro <b>418</b>		
CLASSIC	<b>Avena</b> G51	LGQ15051BSO
	<b>Antracite</b> G59	LGQ15059BSO
	<b>Bianco Antico</b> G62	LGQ15062BSO

# QUADRA 200 SOTTOTOP



**Black**  
K86

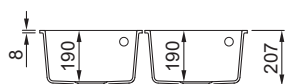
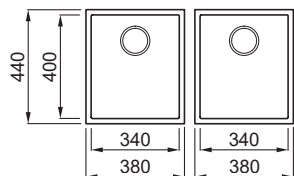

Lavello 2 vasche



### CARATTERISTICHE

Dimensioni (mm) **380 x 440 + 380 x 440**  
 Base (mm) **900**  
 Foro da incasso (mm) **340 x 400 R5 + 340 x 400 R5 (distanza min 50 mm, max 200 mm)**  
 Profondità Vasca 1 (mm) **190**  
 Profondità Vasca 2 (mm) **190**  
 Installazione **Sottotop**  
 Orientamento **Non reversibile**

### ACCESSORI CONSIGLIATI

- 152 157 163 75 43 9

### MATERIALI E COLORI

KERATEK GERAMO NANOTECHNOLOGY ONE		Euro 703
● Black K86		LKQ20086BSO
● Dove Grey K93		LKQ20093BSO
● Champagne K95		LKQ20095BSO
● White K96		LKQ20096BSO
● Light Grey K97		LKQ20097BSO
● Dark Grey K99		LKQ20099BSO

GRANITEK NATURAL GRANITE EFFECT		Euro 578
METAL ● Titanium M73		LMQ20073BSO
● Aluminium M79		LMQ20079BSO

MATT		Euro 553
● Nero G40		LGQ20040BSO
● Tortora G43		LGQ20043BSO
● Cemento G48		LGQ20048BSO
● Bianco G68		LGQ20068BSO
● Espresso G78		LGQ20078BSO

CLASSIC		Euro 553
● Avena G51		LGQ20051BSO
● Antracite G59		LGQ20059BSO
● Bianco Antico G62		LGQ20062BSO



Lavello Quadra 350 Sottotop Bianco G68 | Miscelatore Cloud Bianco G68



MAGGIORI  
INFORMAZIONI  
LINEA BEST



#### L'EFFICIENZA DELLE GEOMETRIE RAZIONALI

Best è la collezione di lavelli in composito dall'estetica razionale che permette il massimo dell'efficienza grazie al bordo salva goccia professional e allo scorrimento degli accessori lungo tutto il lavello. I lavelli Best dispongono di spartivasche maggiorato con area miscelatori integrata, per un utilizzo più completo.

#### PLUS BEST



ACCESSORI  
ELEMENT



BORDO  
SALVAGOCCIA







SPARTIVASCHE  
MAGGIORATO



FLOW PRO

**GRANITEK**<sup>®</sup>  
NATURAL GRANITE EFFECT

-  **Titanium**  
M73
-  **Aluminium**  
M79
-  **Nero**  
G40
-  **Tortora**  
G43
-  **Cemento**  
G48
-  **Bianco**  
G68
-  **Espresso**  
G78

-  **Avena**  
G51
-  **Antracite**  
G59
-  **Bianco Antico**  
G62

**KERATEK**<sup>®</sup>  
CERAMIC NANOTECHNOLOGY CN6

-  **Black**  
K86
-  **Dove Grey**  
K93
-  **Champagne**  
K95
-  **White**  
K96
-  **Light Grey**  
K97
-  **Dark Grey**  
K99

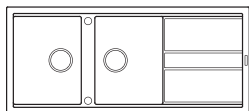
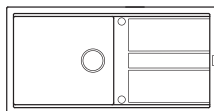
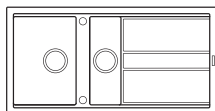
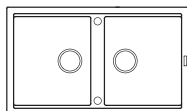
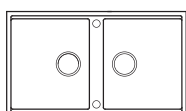
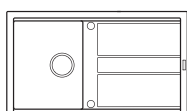

I MODELLI  
**BEST**BEST **500**BEST **480**BEST **475**BEST **450**BEST **450 SOTTOTOP**BEST **400**

**Corredo del lavello:** Sifone salvaspazio, piletta Flow Pro integrata, troppopieno rettangolare e ganci.

**ACCESSORI  
CONSIGLIATI**

89

**ELEMENT TAGLIERE  
BEST LINE**  
ATH0200L  
Pag. **142**

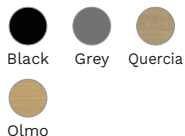
**Finiture**

156

**ELEMENT DRAINER  
FLEX 500**  
ARS023BK  
Pag. **144**

**Finiture**

5

**COLANDER BEST**

AVI03000  
Pag. **150**



97

**ELEMENT POP-UP  
PUSH CONTROL**  
ASP13002BK  
Pag. **147**

**Finiture**

\*Per ulteriori informazioni vai alla sezione accessori a pag. **140**

IL PERFETTO  
**MATCH**  
**MISCELATORI**

**STREAM PLUS - Nero G40**  
MGKSTP40

Pag. **158**

Disponibile nelle colorazioni

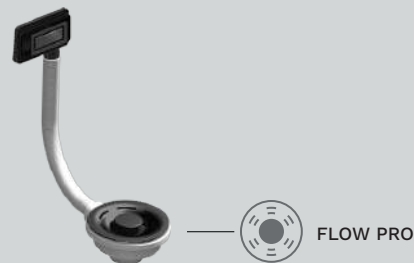
**OPTIONAL**

KIT ELEMENT  
**FLOW PRO + TROPPO PIENO BLACK**  
KITWPT-F-1VSL-L-BK

Pag. **146****elleci | BEAUTY**

Una linea di prodotti appositamente studiata per la cura dei lavelli in composito.

Scopri di più a pag. **200**

# BEST 500



Dark Grey  
K99

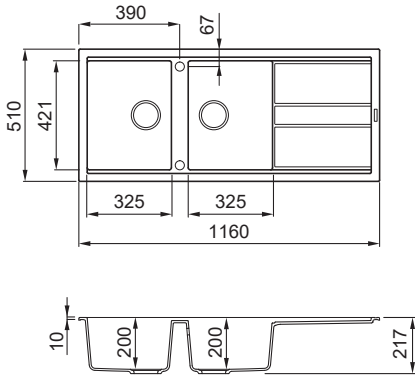

Lavello 2 vasche con gocciolatoio



### CARATTERISTICHE

Dimensioni (mm) **1160 x 510**  
 Base (mm) **800**  
 Foro da incasso (mm) **1140 x 480**  
 Profondità Vasca 1 (mm) **200**  
 Profondità Vasca 2 (mm) **200**  
 Installazione **Sopratop**  
 Orientamento **Reversibile**

### ACCESSORI CONSIGLIATI

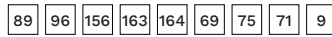

### MATERIALI E COLORI

KERATEK GERMIC NANOTECHNOLOGY DMR		Euro <b>721</b>
	<b>Black</b> K86	LKB50086
	<b>Dove Grey</b> K93	LKB50093
	<b>Champagne</b> K95	LKB50095
	<b>White</b> K96	LKB50096
	<b>Light Grey</b> K97	LKB50097
	<b>Dark Grey</b> K99	LKB50099

GRANITEK NATURAL GRANITE EFFECT		Euro <b>566</b>
	<b>Titanium</b> M73	LMB50073
	<b>Aluminium</b> M79	LMB50079

MATT		Euro <b>538</b>
	<b>Nero</b> G40	LGB50040
	<b>Tortora</b> G43	LGB50043
	<b>Cemento</b> G48	LGB50048
	<b>Bianco</b> G68	LGB50068
	<b>Espresso</b> G78	LGB50078

CLASSIC		Euro <b>538</b>
	<b>Avena</b> G51	LGB50051
	<b>Antracite</b> G59	LGB50059
	<b>Bianco Antico</b> G62	LGB50062

# BEST 480



Dark Grey  
K99

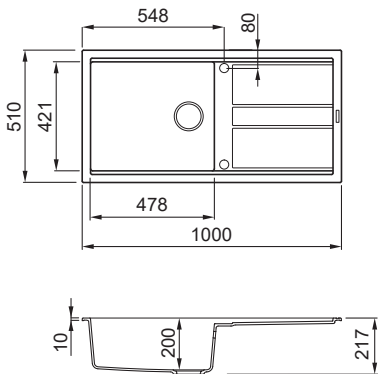

Lavello 1 vasca con gocciolatoio



### CARATTERISTICHE

Dimensioni (mm) **1000 x 510**  
 Base (mm) **600**  
 Foro da incasso (mm) **980 x 480**  
 Profondità Vasca (mm) **200**  
 Installazione **Sopratop**  
 Orientamento **Reversibile**

### ACCESSORI CONSIGLIATI

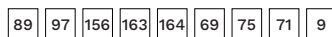

### MATERIALI E COLORI

KERATEK GERMIC NANOTECHNOLOGY DMR		Euro <b>698</b>
	<b>Black</b> K86	LKB48086
	<b>Dove Grey</b> K93	LKB48093
	<b>Champagne</b> K95	LKB48095
	<b>White</b> K96	LKB48096
	<b>Light Grey</b> K97	LKB48097
	<b>Dark Grey</b> K99	LKB48099

GRANITEK NATURAL GRANITE EFFECT		Euro <b>546</b>
	<b>Titanium</b> M73	LMB48073
	<b>Aluminium</b> M79	LMB48079

MATT		Euro <b>524</b>
	<b>Nero</b> G40	LGB48040
	<b>Tortora</b> G43	LGB48043
	<b>Cemento</b> G48	LGB48048
	<b>Bianco</b> G68	LGB48068
	<b>Espresso</b> G78	LGB48078

CLASSIC		Euro <b>524</b>
	<b>Avena</b> G51	LGB48051
	<b>Antracite</b> G59	LGB48059
	<b>Bianco Antico</b> G62	LGB48062

## BEST 475



White  
K96

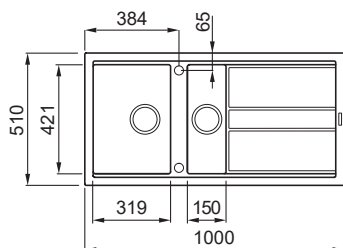

Lavello 1 vasca ½ con gocciolatoio



### CARATTERISTICHE

Dimensioni (mm) **1000 x 510**  
 Base (mm) **600**  
 Foro da incasso (mm) **980 x 480**  
 Profondità Vasca 1 (mm) **200**  
 Profondità Vasca 2 (mm) **140**  
 Installazione **Sopratop**  
 Orientamento **Reversibile**

### ACCESSORI CONSIGLIATI

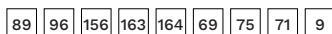

### MATERIALI E COLORI

KERATEX GERAM: NANOTECHNOLOGY ONE		Euro <b>707</b>
● Black K86		LKB47586
● Dove Grey K93		LKB47593
● Champagne K95		LKB47595
● White K96		LKB47596
● Light Grey K97		LKB47597
● Dark Grey K99		LKB47599

GRANITEK  
NATURAL GRANITE EFFECT

GRANITEK NATURAL GRANITE EFFECT		Euro <b>552</b>
METAL ● Titanium M73		LMB47573
● Aluminium M79		LMB47579

GRANITEK NATURAL GRANITE EFFECT		Euro <b>527</b>
MATT ● Nero G40		LGB47540
● Tortora G43		LGB47543
● Cemento G48		LGB47548
● Bianco G68		LGB47568
● Espresso G78		LGB47578

GRANITEK NATURAL GRANITE EFFECT		Euro <b>527</b>
CLASSIC ● Avena G51		LGB47551
● Antracite G59		LGB47559
● Bianco Antico G62		LGB47562

## BEST 400



White  
K96

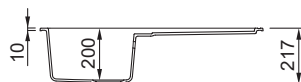
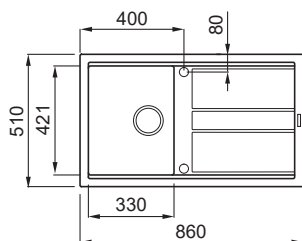

Lavello 1 vasca con gocciolatoio



### CARATTERISTICHE

Dimensioni (mm) **860 x 510**  
 Base (mm) **450**  
 Foro da incasso (mm) **840 x 480**  
 Profondità Vasca (mm) **200**  
 Installazione **Sopratop**  
 Orientamento **Reversibile**

### ACCESSORI CONSIGLIATI

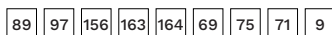

### MATERIALI E COLORI

KERATEX GERAM: NANOTECHNOLOGY ONE		Euro <b>617</b>
● Black K86		LKB40086
● Dove Grey K93		LKB40093
● Champagne K95		LKB40095
● White K96		LKB40096
● Light Grey K97		LKB40097
● Dark Grey K99		LKB40099

GRANITEK  
NATURAL GRANITE EFFECT

GRANITEK NATURAL GRANITE EFFECT		Euro <b>480</b>
METAL ● Titanium M73		LMB40073
● Aluminium M79		LMB40079

GRANITEK NATURAL GRANITE EFFECT		Euro <b>454</b>
MATT ● Nero G40		LGB40040
● Tortora G43		LGB40043
● Cemento G48		LGB40048
● Bianco G68		LGB40068
● Espresso G78		LGB40078

GRANITEK NATURAL GRANITE EFFECT		Euro <b>454</b>
CLASSIC ● Avena G51		LGB40051
● Antracite G59		LGB40059
● Bianco Antico G62		LGB40062

# BEST 450



Nero G40

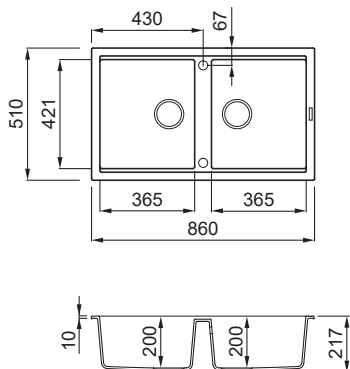

Lavello 2 vasche



### CARATTERISTICHE

Dimensioni (mm) **860 x 510**  
 Base (mm) **900**  
 Foro da incasso (mm) **840 x 480**  
 Profondità Vasca 1 (mm) **200**  
 Profondità Vasca 2 (mm) **200**  
 Installazione **Sopratop**  
 Orientamento **Reversibile**

### ACCESSORI CONSIGLIATI

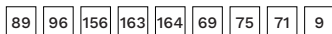

### MATERIALI E COLORI

KERATEK GERMIC NANOTECHNOLOGY DNE		Euro <b>646</b>
	<b>Black</b> K86	LKB45086
	<b>Dove Grey</b> K93	LKB45093
	<b>Champagne</b> K95	LKB45095
	<b>White</b> K96	LKB45096
	<b>Light Grey</b> K97	LKB45097
	<b>Dark Grey</b> K99	LKB45099

GRANITEK NATURAL GRANITE EFFECT		Euro <b>505</b>
<b>METAL</b>	<b>Titanium</b> M73	LMB45073
	<b>Aluminium</b> M79	LMB45079

<b>MATT</b>	<b>Nero</b> G40	LGB45040
	<b>Tortora</b> G43	LGB45043
	<b>Cemento</b> G48	LGB45048
	<b>Bianco</b> G68	LGB45068
	<b>Espresso</b> G78	LGB45078

<b>CLASSIC</b>	<b>Avena</b> G51	LGB45051
	<b>Antracite</b> G59	LGB45059
	<b>Bianco Antico</b> G62	LGB45062

# BEST 450 SOTTOTOP



Nero G40

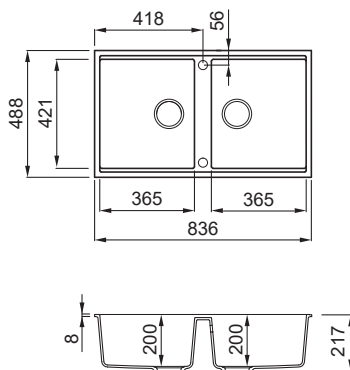

Lavello 2 vasche



### CARATTERISTICHE

Dimensioni (mm) **836 x 488**  
 Base (mm) **900**  
 Foro da incasso (mm) **795 x 448 R6**  
 Profondità Vasca 1 (mm) **200**  
 Profondità Vasca 2 (mm) **200**  
 Installazione **Sottotop**  
 Orientamento **Reversibile**

### ACCESSORI CONSIGLIATI

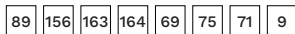

### MATERIALI E COLORI

KERATEK GERMIC NANOTECHNOLOGY DNE		Euro <b>677</b>
	<b>Black</b> K86	LKB45086BSO
	<b>Dove Grey</b> K93	LKB45093BSO
	<b>Champagne</b> K95	LKB45095BSO
	<b>White</b> K96	LKB45096BSO
	<b>Light Grey</b> K97	LKB45097BSO
	<b>Dark Grey</b> K99	LKB45099BSO

GRANITEK NATURAL GRANITE EFFECT		Euro <b>530</b>
<b>METAL</b>	<b>Titanium</b> M73	LMB45073BSO
	<b>Aluminium</b> M79	LMB45079BSO

<b>MATT</b>	<b>Nero</b> G40	LGB45040BSO
	<b>Tortora</b> G43	LGB45043BSO
	<b>Cemento</b> G48	LGB45048BSO
	<b>Bianco</b> G68	LGB45068BSO
	<b>Espresso</b> G78	LGB45078BSO

<b>CLASSIC</b>	<b>Avena</b> G51	LGB45051BSO
	<b>Antracite</b> G59	LGB45059BSO
	<b>Bianco Antico</b> G62	LGB45062BSO



Lavello Best 480 Titanium M73 | Miscelatore Stream Cromato



MAGGIORI  
INFORMAZIONI  
LINEA UNICO



### ELOGIO DELL'UNICITÀ

Unicità è una parola magica. Essere unici significa immaginare e creare prodotti e spazi che non c'erano, sentirsi meglio con sé stessi, provare strade mai percorse per tracciare una nuova rotta. La tua.

## PLUS UNICO



VASCA XL







ACCESSORI  
ELEMENT







AREA  
ACCESSORI  
INTEGRATA

### **GRANITEK**<sup>®</sup> NATURAL GRANITE EFFECT

-  **Titanium**  
M73
-  **Aluminium**  
M79
-  **Nero**  
G40
-  **Tortora**  
G43
-  **Cemento**  
G48
-  **Bianco**  
G68
-  **Espresso**  
G78

-  **Avena**  
G51
-  **Antracite**  
G59
-  **Bianco Antico**  
G62

### **KERATEK**<sup>®</sup> CERAMIC NANOTECHNOLOGY CN6

-  **Black**  
K86
-  **Dove Grey**  
K93
-  **White**  
K96
-  **Light Grey**  
K97

## I MODELLI UNICO

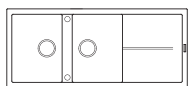

UNICO 500

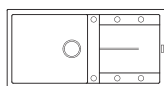

UNICO 480

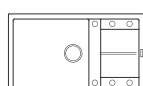

UNICO 410

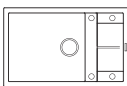

UNICO 310

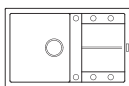

UNICO 300

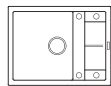

UNICO 125

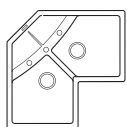

UNICO CORNER

**Corredo del lavello:** Sifone salvaspazio, troppopieno tondo, pilette e ganci.

## ACCESSORI CONSIGLIATI

88

### ELEMENT TAGLIERE SLIDING 50 CM

ATH010QU  
Pag. 142



#### Finiture

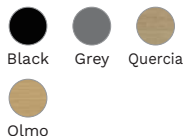

156

### ELEMENT DRAINER FLEX 500

ARS023BK  
Pag. 144



#### Finiture



97

### ELEMENT POP-UP PUSH CONTROL

ASP13002BK  
Pag. 147



#### Finiture

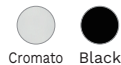

75

### CESTELLO

ACI01307  
Pag. 151



\*Per ulteriori informazioni vai alla sezione accessori a pag. 140

## IL PERFETTO MATCH MISCELATORI



### TRAIL - Cemento G48 MGKTRA48

Pag. 159

Disponibile nelle colorazioni



## OPTIONAL



### KIT ELEMENT ELEMENT POP UP PUSH CONTROL ASP23002

Pag. 147

## elleci | BEAUTY



Una linea di prodotti appositamente studiata per la cura dei lavelli in composito.

Scopri di più a pag. 200

# UNICO 500



Titanium  
M73

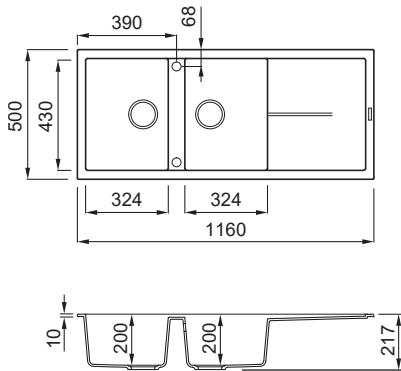

Lavello 2 vasche con gocciolatoio



### CARATTERISTICHE

Dimensioni (mm) **1160 x 500**  
 Base (mm) **800**  
 Foro da incasso (mm) **1140 x 480**  
 Profondità Vasca 1 (mm) **200**  
 Profondità Vasca 2 (mm) **200**  
 Installazione **Sopratop**  
 Orientamento **Reversibile**

### ACCESSORI CONSIGLIATI

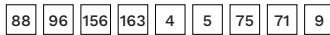

### MATERIALI E COLORI

KERATEK GERMIC NANOTECHNOLOGY DNR		Euro <b>643</b>
	<b>Black</b> K86	LKU50086
	<b>Dove Grey</b> K93	LKU50093
	<b>White</b> K96	LKU50096
	<b>Light Grey</b> K97	LKU50097

GRANITEK NATURAL GRANITE EFFECT		Euro <b>517</b>	
METAL		<b>Titanium</b> M73	LMU50073
		<b>Aluminium</b> M79	LMU50079

MATT		<b>Nero</b> G40	Euro <b>496</b> LGU50040
		<b>Tortora</b> G43	LGU50043
		<b>Cemento</b> G48	LGU50048
		<b>Bianco</b> G68	LGU50068

CLASSIC		<b>Espresso</b> G78	LGU50078
		<b>Avena</b> G51	Euro <b>496</b> LGU50051
		<b>Antracite</b> G59	LGU50059

		<b>Bianco Antico</b> G62	LGU50062
--	--	-----------------------------	----------

# UNICO 480



Titanium  
M73

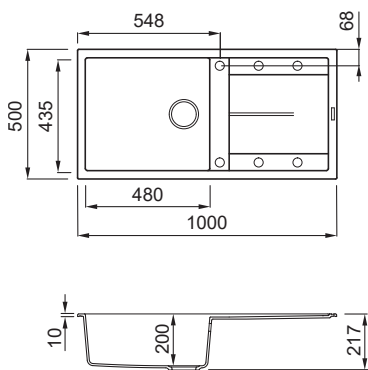

Lavello 1 vasca con gocciolatoio



### CARATTERISTICHE

Dimensioni (mm) **1000 x 500**  
 Base (mm) **600**  
 Foro da incasso (mm) **980 x 480**  
 Profondità Vasca (mm) **200**  
 Installazione **Sopratop**  
 Orientamento **Reversibile**

### ACCESSORI CONSIGLIATI

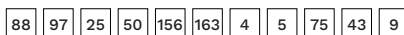

### MATERIALI E COLORI

KERATEK GERMIC NANOTECHNOLOGY DNR		Euro <b>640</b>
	<b>Black</b> K86	LKU48086
	<b>Dove Grey</b> K93	LKU48093
	<b>White</b> K96	LKU48096
	<b>Light Grey</b> K97	LKU48097

GRANITEK NATURAL GRANITE EFFECT		Euro <b>514</b>	
METAL		<b>Titanium</b> M73	LMU48073
		<b>Aluminium</b> M79	LMU48079

MATT		<b>Nero</b> G40	Euro <b>490</b> LGU48040
		<b>Tortora</b> G43	LGU48043
		<b>Cemento</b> G48	LGU48048
		<b>Bianco</b> G68	LGU48068

CLASSIC		<b>Espresso</b> G78	LGU48078
		<b>Avena</b> G51	Euro <b>490</b> LGU48051
		<b>Antracite</b> G59	LGU48059

		<b>Bianco Antico</b> G62	LGU48062
--	--	-----------------------------	----------



## UNICO 410



Aluminium  
M79

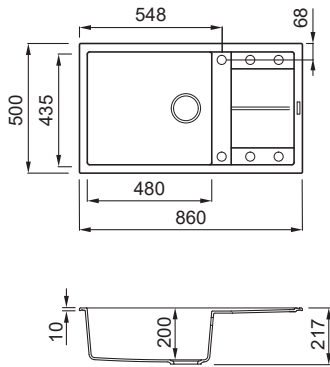

Lavello 1 vasca con gocciolatoio



### CARATTERISTICHE

Dimensioni (mm) **860 x 500**  
 Base (mm) **600**  
 Foro da incasso (mm) **840 x 480**  
 Profondità Vasca (mm) **200**  
 Installazione **Sopratop**  
 Orientamento **Reversibile**

### ACCESSORI CONSIGLIATI

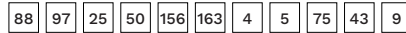

### MATERIALI E COLORI

KERATEX <small>CERAMIC NANOTECHNOLOGY ONE</small>		Euro <b>567</b>
	<b>Black</b> K86	LKU41086
	<b>Dove Grey</b> K93	LKU41093
	<b>White</b> K96	LKU41096
	<b>Light Grey</b> K97	LKU41097

GRANITEK <small>NATURAL GRANITE EFFECT</small>		Euro <b>454</b>
	<b>Titanium</b> M73	LMU41073
	<b>Aluminium</b> M79	LMU41079

METAL

MATT

	<b>Nero</b> G40	Euro <b>433</b> LGU41040
	<b>Tortora</b> G43	LGU41043
	<b>Cemento</b> G48	LGU41048
	<b>Bianco</b> G68	LGU41068
	<b>Espresso</b> G78	LGU41078

CLASSIC

	<b>Avena</b> G51	Euro <b>433</b> LGU41051
	<b>Antracite</b> G59	LGU41059
	<b>Bianco Antico</b> G62	LGU41062

## UNICO 310



Aluminium  
M79

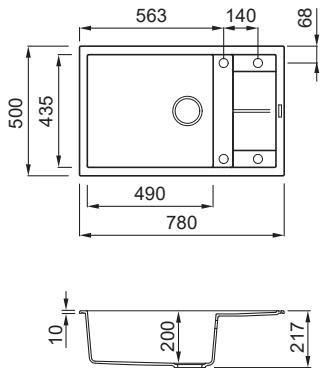

Lavello 1 vasca con gocciolatoio



### CARATTERISTICHE

Dimensioni (mm) **780 x 500**  
 Base (mm) **600 ||| 800 se inizio composizione**  
 Foro da incasso (mm) **760 x 480**  
 Profondità Vasca (mm) **200**  
 Installazione **Sopratop**  
 Orientamento **Reversibile**

### ACCESSORI CONSIGLIATI

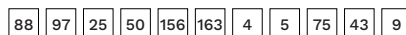

### MATERIALI E COLORI

KERATEX <small>CERAMIC NANOTECHNOLOGY ONE</small>		Euro <b>567</b>
	<b>Black</b> K86	LKU31086
	<b>Dove Grey</b> K93	LKU31093
	<b>White</b> K96	LKU31096
	<b>Light Grey</b> K97	LKU31097

GRANITEK <small>NATURAL GRANITE EFFECT</small>		Euro <b>454</b>
	<b>Titanium</b> M73	LMU31073
	<b>Aluminium</b> M79	LMU31079

METAL

MATT

	<b>Nero</b> G40	Euro <b>433</b> LGU31040
	<b>Tortora</b> G43	LGU31043
	<b>Cemento</b> G48	LGU31048
	<b>Bianco</b> G68	LGU31068
	<b>Espresso</b> G78	LGU31078

CLASSIC

	<b>Avena</b> G51	Euro <b>433</b> LGU31051
	<b>Antracite</b> G59	LGU31059
	<b>Bianco Antico</b> G62	LGU31062

# UNICO 300



Nero G40

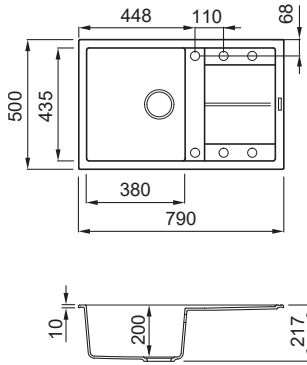

Lavello 1 vasca con gocciolatoio



### CARATTERISTICHE

Dimensioni (mm) **790 x 500**  
 Base (mm) **500**  
 Foro da incasso (mm) **770 x 480**  
 Profondità Vasca (mm) **200**  
 Installazione **Sopratop**  
 Orientamento **Reversibile**

### ACCESSORI CONSIGLIATI

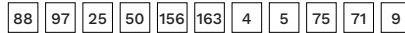

### MATERIALI E COLORI

KERATEK GERMIC NANOTECHNOLOGY DNR		Euro 554
	<b>Black</b> K86	LKU30086
	<b>Dove Grey</b> K93	LKU30093
	<b>White</b> K96	LKU30096
	<b>Light Grey</b> K97	LKU30097

GRANITEK NATURAL GRANITE EFFECT		Euro 444
<b>METAL</b>	<b>Titanium</b> M73	LMU30073
	<b>Aluminium</b> M79	LMU30079

<b>MATT</b>	<b>Nero</b> G40	LGU30040
	<b>Tortora</b> G43	LGU30043
	<b>Cemento</b> G48	LGU30048
	<b>Bianco</b> G68	LGU30068
	<b>Espresso</b> G78	LGU30078

<b>CLASSIC</b>	<b>Avena</b> G51	LGU30051
	<b>Antracite</b> G59	LGU30059
	<b>Bianco Antico</b> G62	LGU30062

# UNICO 125



Nero G40

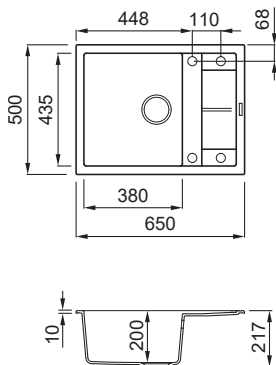

Lavello 1 vasca con gocciolatoio



### CARATTERISTICHE

Dimensioni (mm) **650 x 500**  
 Base (mm) **500**  
 Foro da incasso (mm) **630 x 480**  
 Profondità Vasca (mm) **200**  
 Installazione **Sopratop**  
 Orientamento **Reversibile**

### ACCESSORI CONSIGLIATI

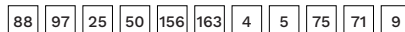

### MATERIALI E COLORI

KERATEK GERMIC NANOTECHNOLOGY DNR		Euro 512
	<b>Black</b> K86	LKU12586
	<b>Dove Grey</b> K93	LKU12593
	<b>White</b> K96	LKU12596
	<b>Light Grey</b> K97	LKU12597

GRANITEK NATURAL GRANITE EFFECT		Euro 411
<b>METAL</b>	<b>Titanium</b> M73	LMU12573
	<b>Aluminium</b> M79	LMU12579

<b>MATT</b>	<b>Nero</b> G40	LGU12540
	<b>Tortora</b> G43	LGU12543
	<b>Cemento</b> G48	LGU12548
	<b>Bianco</b> G68	LGU12568
	<b>Espresso</b> G78	LGU12578

<b>CLASSIC</b>	<b>Avena</b> G51	LGU12551
	<b>Antracite</b> G59	LGU12559
	<b>Bianco Antico</b> G62	LGU12562

# UNICO CORNER



Bianco  
G68

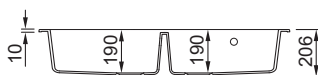
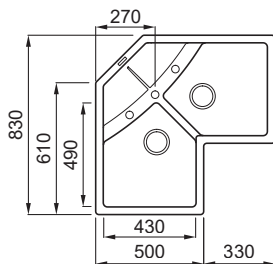

Lavello angolare 2 vasche con  
gocciolatoio



### CARATTERISTICHE

Dimensioni (mm) **830 x 830**  
 Base (mm) **Corner**  
 Foro da incasso (mm) **Da dima\***  
 Profondità Vasca 1 (mm) **190**  
 Profondità Vasca 2 (mm) **190**  
 Installazione **Sopratop**  
 Orientamento **Reversibile**

### ACCESSORI CONSIGLIATI

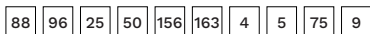

### MATERIALI E COLORI

**GRANITEK**  
NATURAL GRANITE EFFECT

METAL

- Titanium**  
M73
- Aluminium**  
M79

Euro **708**  
LMUCOR73  
LMUCOR79

MATT

- Nero**  
G40
- Tortora**  
G43
- Cemento**  
G48
- Bianco**  
G68
- Espresso**  
G78

Euro **678**  
LGUCOR40  
LGUCOR43  
LGUCOR48  
LGUCOR68  
LGUCOR78

CLASSIC

- Avena**  
G51
- Antracite**  
G59
- Bianco Antico**  
G62

Euro **678**  
LGUCOR51  
LGUCOR59  
LGUCOR62

\*dima inclusa nella confezione o scaricabile dalla sezione download specifica del sito [www.elleci.com/it](http://www.elleci.com/it)



Lavello Unico Corner Nero G40 | Miscelatore Trail Plus Nero G40



MAGGIORI  
INFORMAZIONI  
LINEA EGO



**DESIGN AVVOLGENTE**

Una collezione di lavelli studiata per incontrare morbidi gusti. Le linee che la compongono sono molto leggere e formano delle curve che ne conferiscono un design avvolgente. Ogni modello è combinabile con numerosi accessori e molteplici colorazioni.

PLUS **EGO**



ACCESSORI  
ELEMENT



DESIGN  
AVVOLGENTE

**GRANITEK**<sup>®</sup>  
NATURAL GRANITE EFFECT

● **Titanium**  
M73

● **Aluminium**  
M79

● **Nero**  
G40

● **Tortora**  
G43

● **Cemento**  
G48

● **Bianco**  
G68

● **Avena**  
G51

● **Antracite**  
G59

● **Bianco Antico**  
G62

## I MODELLI EGO

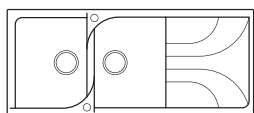

EGO **500**

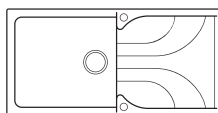

EGO **480**

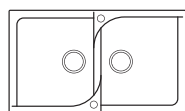

EGO **450**

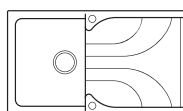

EGO **400**

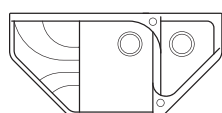

EGO **ESA**

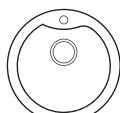

EGO **ROUND**

**Corredo del lavello:** Sifone salvaspazio, troppopieno tondo, pilette e ganci.

## ACCESSORI CONSIGLIATI

88

### ELEMENT TAGLIERE SLIDING 50 CM

ATH010QU  
Pag. **142**



#### Finiture

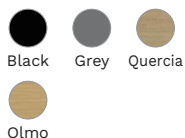

156

### ELEMENT DRAINER FLEX 500

ARS023BK  
Pag. **144**



#### Finiture



96

### ELEMENT POP-UP PUSH CONTROL 2 VIE

ASP23002  
Pag. **147**



#### Finiture



5

### COLANDER

AVI03001  
Pag. **150**



\*Per ulteriori informazioni vai alla sezione accessori a pag. **140**

## IL PERFETTO MATCH MISCELATORI



### VOLTA - Titanium M73 MMKVTAT73

Pag. **164**

Disponibile nelle colorazioni



## OPTIONAL



### KIT ELEMENT ELEMENT POP UP PUSH CONTROL ASP23002

Pag. **147**

## elleci | BEAUTY



Una linea di prodotti appositamente studiata per la cura dei lavelli in composito.

Scopri di più a pag. **200**

# EGO 500



Nero G40

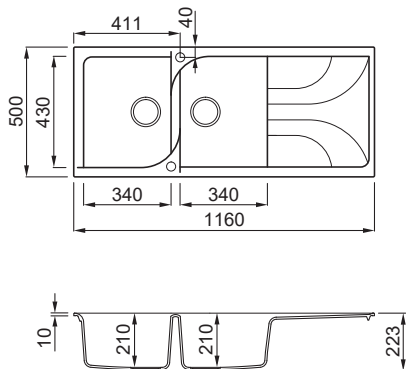

Lavello 2 vasche con gocciolatoio



### CARATTERISTICHE

Dimensioni (mm) **1160 x 500**  
 Base (mm) **800**  
 Foro da incasso (mm) **1140 x 485**  
 Profondità Vasca 1 (mm) **210**  
 Profondità Vasca 2 (mm) **210**  
 Installazione **Sopratop**  
 Orientamento **Reversibile**

### ACCESSORI CONSIGLIATI

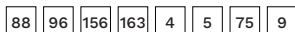

### MATERIALI E COLORI

		<b>GRANITEK</b> NATURAL GRANITE EFFECT	Euro <b>496</b>
METAL		<b>Titanium</b> M73	LME50073
		<b>Aluminium</b> M79	LME50079
			Euro <b>473</b>
MATT		<b>Nero</b> G40	LGE50040
		<b>Tortora</b> G43	LGE50043
		<b>Cemento</b> G48	LGE50048
		<b>Bianco</b> G68	LGE50068
			Euro <b>473</b>
CLASSIC		<b>Avena</b> G51	LGE50051
		<b>Antracite</b> G59	LGE50059
		<b>Bianco Antico</b> G62	LGE50062

# EGO 480



Nero G40

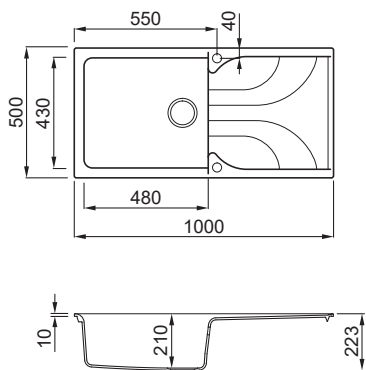

Lavello 1 vasca con gocciolatoio



### CARATTERISTICHE

Dimensioni (mm) **1000 x 500**  
 Base (mm) **600**  
 Foro da incasso (mm) **980 x 485**  
 Profondità Vasca (mm) **210**  
 Installazione **Sopratop**  
 Orientamento **Reversibile**

### ACCESSORI CONSIGLIATI

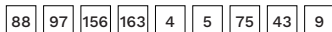

### MATERIALI E COLORI

		<b>GRANITEK</b> NATURAL GRANITE EFFECT	Euro <b>490</b>
METAL		<b>Titanium</b> M73	LME48073
		<b>Aluminium</b> M79	LME48079
			Euro <b>461</b>
MATT		<b>Nero</b> G40	LGE48040
		<b>Tortora</b> G43	LGE48043
		<b>Cemento</b> G48	LGE48048
		<b>Bianco</b> G68	LGE48068
			Euro <b>461</b>
CLASSIC		<b>Avena</b> G51	LGE48051
		<b>Antracite</b> G59	LGE48059
		<b>Bianco Antico</b> G62	LGE48062

## EGO 400



Bianco  
G68

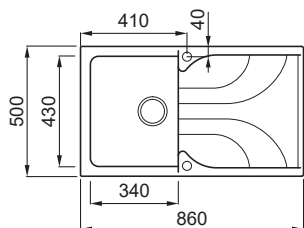

Lavello 1 vasca con gocciolatoio



### CARATTERISTICHE

Dimensioni (mm)	<b>860 x 500</b>
Base (mm)	<b>450</b>
Foro da incasso (mm)	<b>840 x 490</b>
Profondità Vasca (mm)	<b>210</b>
Installazione	<b>Sopratop</b>
Orientamento	<b>Reversibile</b>

### ACCESSORI CONSIGLIATI



### MATERIALI E COLORI

**GRANITEK**  
NATURAL GRANITE EFFECT

METAL

- Titanium M73
- Aluminium M79

Euro **424**  
LME40073  
LME40079

MATT

- Nero G40
- Tortora G43
- Cemento G48
- Bianco G68

Euro **406**  
LGE40040  
LGE40043  
LGE40048  
LGE40068

CLASSIC

- Avena G51
- Antracite G59
- Bianco Antico G62

Euro **406**  
LGE40051  
LGE40059  
LGE40062

## EGO 450



Bianco  
G68

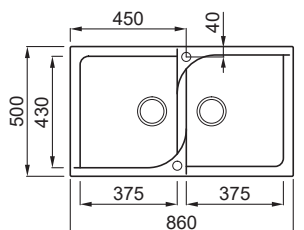

Lavello 2 vasche



### CARATTERISTICHE

Dimensioni (mm)	<b>860 x 500</b>
Base (mm)	<b>900</b>
Foro da incasso (mm)	<b>840 x 485</b>
Profondità Vasca 1 (mm)	<b>210</b>
Profondità Vasca 2 (mm)	<b>210</b>
Installazione	<b>Sopratop</b>
Orientamento	<b>Reversibile</b>

### ACCESSORI CONSIGLIATI

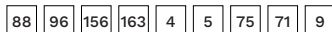

### MATERIALI E COLORI

**GRANITEK**  
NATURAL GRANITE EFFECT

METAL

- Titanium M73
- Aluminium M79

Euro **451**  
LME45073  
LME45079

MATT

- Nero G40
- Tortora G43
- Cemento G48
- Bianco G68

Euro **428**  
LGE45040  
LGE45043  
LGE45048  
LGE45068

CLASSIC

- Avena G51
- Antracite G59
- Bianco Antico G62

Euro **428**  
LGE45051  
LGE45059  
LGE45062

# EGO ROUND



Titanium M73

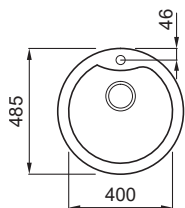

Lavello 1 vasca



### CARATTERISTICHE

Dimensioni (mm)	<b>Ø 485</b>
Base (mm)	<b>500</b>
Foro da incasso (mm)	<b>Ø 465</b>
Profondità Vasca (mm)	<b>210</b>
Installazione	<b>Sopratop</b>
Orientamento	<b>Non reversibile</b>

### ACCESSORI CONSIGLIATI



### MATERIALI E COLORI

<b>GRANITEK</b> NATURAL GRANITE EFFECT		Euro <b>330</b>
METAL	<b>Titanium</b> M73	LGEROU73
	<b>Aluminium</b> M79	LGEROU79
Euro <b>314</b>		
MATT	<b>Nero</b> G40	LGEROU40
	<b>Tortora</b> G43	LGEROU43
	<b>Bianco</b> G68	LGEROU68
Euro <b>314</b>		
CLASSIC	<b>Avena</b> G51	LGEROU51
	<b>Antracite</b> G59	LGEROU59
	<b>Bianco Antico</b> G62	LGEROU62

# EGO ESA



Titanium M73

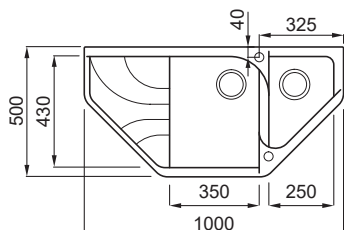

Lavello 2 vasche con gocciolatoio



### CARATTERISTICHE

Dimensioni (mm)	<b>1000 x 500</b>
Base (mm)	<b>800     1200 se inizio composizione a sinistra     800 se inizio composizione a destra</b>
Foro da incasso (mm)	<b>Da dima*</b>
Profondità Vasca 1 (mm)	<b>210</b>
Profondità Vasca 2 (mm)	<b>120</b>
Installazione	<b>Sopratop</b>
Orientamento	<b>Non reversibile</b>

### ACCESSORI CONSIGLIATI

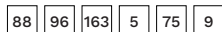

### MATERIALI E COLORI

<b>GRANITEK</b> NATURAL GRANITE EFFECT		Euro <b>476</b>
METAL	<b>Titanium</b> M73	LMEESA73
	<b>Aluminium</b> M79	LMEESA79
Euro <b>451</b>		
MATT	<b>Nero</b> G40	LGEESA40
	<b>Tortora</b> G43	LGEESA43
	<b>Bianco</b> G68	LGEESA68
Euro <b>451</b>		
CLASSIC	<b>Avena</b> G51	LGEESA51
	<b>Antracite</b> G59	LGEESA59
	<b>Bianco Antico</b> G62	LGEESA62

\*dima inclusa nella confezione o scaricabile dalla sezione download specifica del sito [www.elleci.com/it](http://www.elleci.com/it)





Lavello Ego 450 Titanium M73 | Miscelatore Ares Titanium M73



MAGGIORI  
INFORMAZIONI  
LINEA EASY



**L'ESSENZIALE SENZA TEMPO**

Un prodotto unico dallo spiccato carattere innovativo che armonizza una funzionalità estrema con la capacità di poter "modellarsi" alle esigenze di chi lo utilizza fino a poter "scompare" del tutto.

PLUS **EASY**



VASCA XL



ACCESSORI  
ELEMENT



PRISMA  
CLEAN



DESIGN  
ESSENZIALE

**GRANITEK**<sup>®</sup>  
NATURAL GRANITE EFFECT

● **Titanium**  
M73

● **Aluminium**  
M79

● **Nero**  
G40

● **Tortora**  
G43

● **Cemento**  
G48

● **Bianco**  
G68

● **Espresso**  
G78

● **Avena**  
G51

● **Antracite**  
G59

● **Bianco Antico**  
G62

## I MODELLI EASY

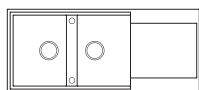

EASY 500

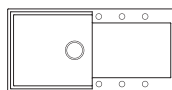

EASY 480

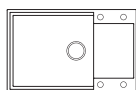

EASY 310

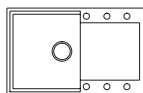

EASY 300

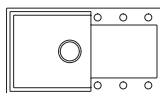

EASY 290

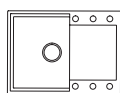

EASY 135

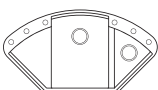

EASY CORNER

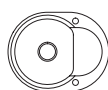

EASY 600 ROUND

**Corredo del lavello:** Sifone salvaspazio, troppopieno tondo, pilette e ganci.

## ACCESSORI CONSIGLIATI

88

### ELEMENT TAGLIERE SLIDING 50 CM

ATH010QU  
Pag. 142



#### Finiture

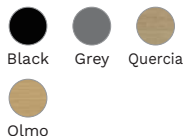

156

### ELEMENT DRAINER FLEX 500

ARS023BK  
Pag. 144

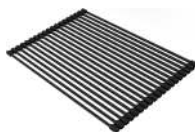

#### Finiture



97

### ELEMENT POP-UP PUSH CONTROL

ASP13002BK  
Pag. 147



#### Finiture



5

### COLANDER

AVI03001  
Pag. 150



\*Per ulteriori informazioni vai alla sezione accessori a pag. 140

## IL PERFETTO MATCH MISCELATORI



### ATHENA - Tortora G43 MGKATH43

Pag. 161

Disponibile nelle colorazioni



## OPTIONAL



### KIT ELEMENT ELEMENT DISPENSER SAPONE TONDO ADIO2300

Pag. 145

## elleci | BEAUTY



Una linea di prodotti appositamente studiata per la cura dei lavelli in composito.

Scopri di più a pag. 200

# EASY 500



Nero G40

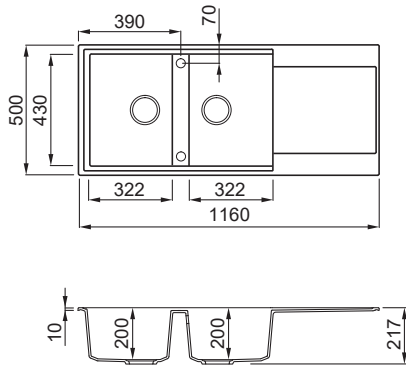

Lavello 2 vasche con gocciolatoio



### CARATTERISTICHE

Dimensioni (mm) **1160 x 500**  
 Base (mm) **800**  
 Foro da incasso (mm) **1140 x 480**  
 Profondità Vasca 1 (mm) **200**  
 Profondità Vasca 2 (mm) **200**  
 Installazione **Sopratop**  
 Orientamento **Reversibile**

### ACCESSORI CONSIGLIATI

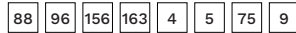

### MATERIALI E COLORI

**GRANITEK**  
NATURAL GRANITE EFFECT

METAL

- Titanium M73
- Aluminium M79

Euro **449**

LMY50073

LMY50079

MATT

- Nero G40
- Tortora G43
- Cemento G48
- Bianco G68
- Espresso G78

Euro **428**

LGY50040

LGY50043

LGY50048

LGY50068

LGY50078

CLASSIC

- Avena G51
- Antracite G59
- Bianco Antico G62

Euro **428**

LGY50051

LGY50059

LGY50062

# EASY 480



Nero G40

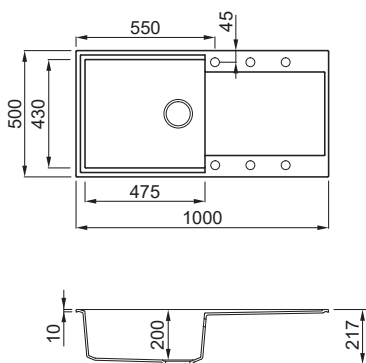

Lavello 1 vasca con gocciolatoio



### CARATTERISTICHE

Dimensioni (mm) **1000 x 500**  
 Base (mm) **600**  
 Foro da incasso (mm) **980 x 480**  
 Profondità Vasca (mm) **200**  
 Installazione **Sopratop**  
 Orientamento **Reversibile**

### ACCESSORI CONSIGLIATI

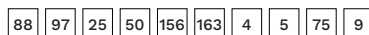

### MATERIALI E COLORI

**GRANITEK**  
NATURAL GRANITE EFFECT

METAL

- Titanium M73
- Aluminium M79

Euro **414**

LMY48073

LMY48079

MATT

- Nero G40
- Tortora G43
- Cemento G48
- Bianco G68
- Espresso G78

Euro **394**

LGY48040

LGY48043

LGY48048

LGY48068

LGY48078

CLASSIC

- Avena G51
- Antracite G59
- Bianco Antico G62

Euro **394**

LGY48051

LGY48059

LGY48062

## EASY 310



Bianco  
G68

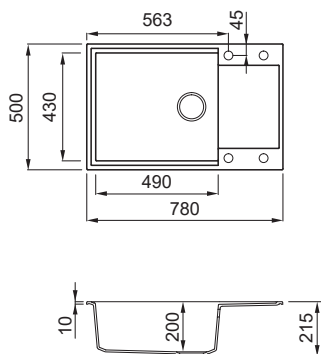

Lavello 1 vasca con gocciolatoio



### CARATTERISTICHE

Dimensioni (mm)	<b>780 x 500</b>
Base (mm)	<b>600     800 se inizio composizione</b>
Foro da incasso (mm)	<b>760 x 480</b>
Profondità Vasca (mm)	<b>200</b>
Installazione	<b>Sopratop</b>
Orientamento	<b>Reversibile</b>

### ACCESSORI CONSIGLIATI

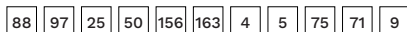

### MATERIALI E COLORI

#### GRANITEK

NATURAL GRANITE EFFECT

METAL		<b>Titanium</b> M73	Euro <b>354</b> LMY31073
		<b>Aluminium</b> M79	LMY31079

MATT		<b>Nero</b> G40	Euro <b>337</b> LGY31040
		<b>Tortora</b> G43	LGY31043
		<b>Cemento</b> G48	LGY31048
		<b>Bianco</b> G68	LGY31068
		<b>Espresso</b> G78	LGY31078

CLASSIC		<b>Avena</b> G51	Euro <b>337</b> LGY31051
		<b>Antracite</b> G59	LGY31059
		<b>Bianco Antico</b> G62	LGY31062

## EASY 300



Bianco  
G68

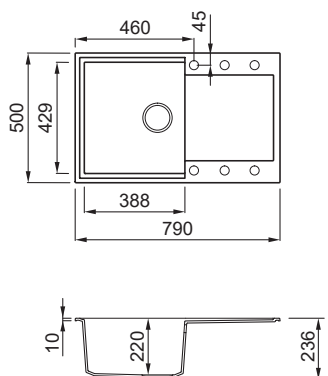

Lavello 1 vasca con gocciolatoio



### CARATTERISTICHE

Dimensioni (mm)	<b>790 x 500</b>
Base (mm)	<b>500     600 se inizio composizione</b>
Foro da incasso (mm)	<b>770 x 480</b>
Profondità Vasca (mm)	<b>220</b>
Installazione	<b>Sopratop</b>
Orientamento	<b>Reversibile</b>

### ACCESSORI CONSIGLIATI

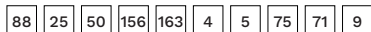

### MATERIALI E COLORI

#### GRANITEK

NATURAL GRANITE EFFECT

METAL		<b>Titanium</b> M73	Euro <b>342</b> LMY30073
		<b>Aluminium</b> M79	LMY30079

MATT		<b>Nero</b> G40	Euro <b>326</b> LGY30040
		<b>Tortora</b> G43	LGY30043
		<b>Cemento</b> G48	LGY30048
		<b>Bianco</b> G68	LGY30068
		<b>Espresso</b> G78	LGY30078

CLASSIC		<b>Avena</b> G51	Euro <b>326</b> LGY30051
		<b>Antracite</b> G59	LGY30059
		<b>Bianco Antico</b> G62	LGY30062

# EASY 290

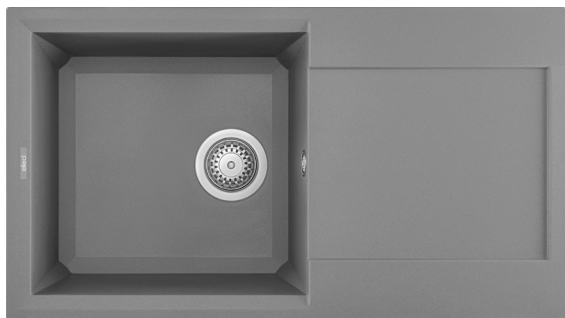

**Titanium**  
M73

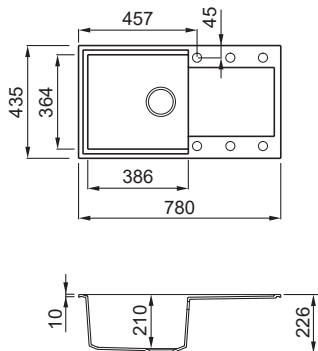

Lavello 1 vasca con gocciolatoio



### CARATTERISTICHE

Dimensioni (mm) **780 x 435**  
 Base (mm) **500 ||| 600 se inizio composizione**  
 Foro da incasso (mm) **760 x 415**  
 Profondità Vasca (mm) **210**  
 Installazione **Sopratop**  
 Orientamento **Reversibile**

### ACCESSORI CONSIGLIATI

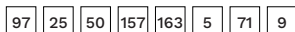

### MATERIALI E COLORI



METAL

- Titanium**  
M73
- Aluminium**  
M79

Euro **342**  
 LMY29073  
 LMY29079

MATT

- Nero**  
G40
- Tortora**  
G43
- Cemento**  
G48
- Bianco**  
G68
- Espresso**  
G78

Euro **326**  
 LGY29040  
 LGY29043  
 LGY29048  
 LGY29068  
 LGY29078

CLASSIC

- Avena**  
G51
- Antracite**  
G59
- Bianco Antico**  
G62

Euro **326**  
 LGY29051  
 LGY29059  
 LGY29062

# EASY 135

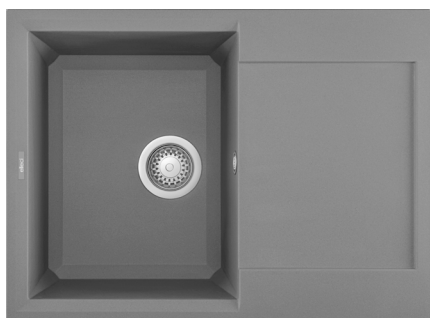

**Titanium**  
M73

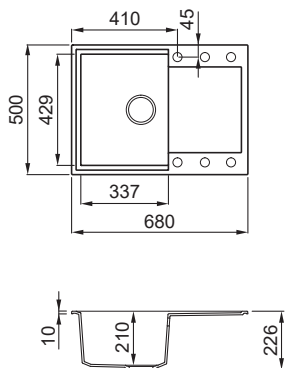

Lavello 1 vasca con gocciolatoio



### CARATTERISTICHE

Dimensioni (mm) **680 x 500**  
 Base (mm) **450 ||| 600 se inizio composizione**  
 Foro da incasso (mm) **660 x 480**  
 Profondità Vasca (mm) **210**  
 Installazione **Sopratop**  
 Orientamento **Reversibile**

### ACCESSORI CONSIGLIATI

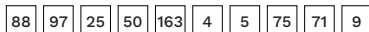

### MATERIALI E COLORI



METAL

- Titanium**  
M73
- Aluminium**  
M79

Euro **291**  
 LMY13573  
 LMY13579

MATT

- Nero**  
G40
- Tortora**  
G43
- Cemento**  
G48
- Bianco**  
G68
- Espresso**  
G78

Euro **277**  
 LGY13540  
 LGY13543  
 LGY13548  
 LGY13568  
 LGY13578

CLASSIC

- Avena**  
G51
- Antracite**  
G59
- Bianco Antico**  
G62

Euro **277**  
 LGY13551  
 LGY13559  
 LGY13562

## EASY CORNER



Aluminium M79

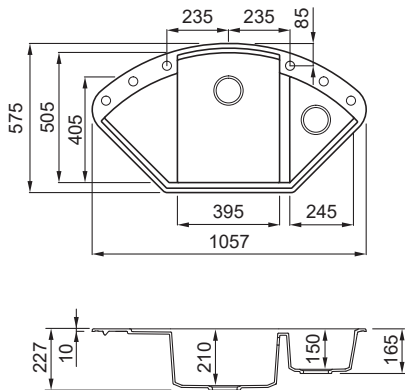

Lavello angolare 1 vasca ½ con gocciolatoio



### CARATTERISTICHE

Dimensioni (mm)  
Base (mm)

**1057 x 575**  
**Corner ||| 800 ||| 1200 se inizio comp. a sx || 800 se inizio comp. a dx (Top minimo 650 mm)**  
**Da dima\***  
**210**  
**150**  
**Sopratop**  
**Non reversibile**

Foro da incasso (mm)  
Profondità Vasca 1 (mm)  
Profondità Vasca 2 (mm)  
Installazione  
Orientamento

### ACCESSORI CONSIGLIATI



### MATERIALI E COLORI

<b>GRANITEK</b> <small>NATURAL GRANITE EFFECT</small>		Euro <b>476</b>
METAL	<b>Titanium M73</b>	LMYC0R73
	<b>Aluminium M79</b>	LMYC0R79
Euro <b>451</b>		
MATT	<b>Nero G40</b>	LGYC0R40
	<b>Tortora G43</b>	LGYC0R43
	<b>Cemento G48</b>	LGYC0R48
	<b>Bianco G68</b>	LGYC0R68
	<b>Espresso G78</b>	LGYC0R78
Euro <b>451</b>		
CLASSIC	<b>Avena G51</b>	LGYC0R51
	<b>Antracite G59</b>	LGYC0R59
	<b>Bianco Antico G62</b>	LGYC0R62

\*dima inclusa nella confezione o scaricabile dalla sezione download specifica del sito [www.elleci.com/it](http://www.elleci.com/it)

## EASY 600 ROUND



Aluminium M79

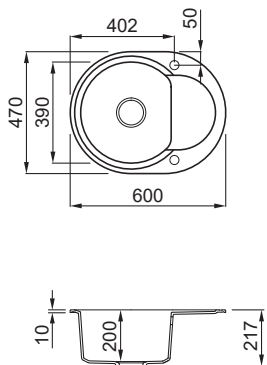

Lavello 1 vasca con gocciolatoio



### CARATTERISTICHE

Dimensioni (mm)  
Base (mm)  
Foro da incasso (mm)  
Profondità Vasca (mm)  
Installazione  
Orientamento

**600 x 470**  
**450**  
**Da dima\***  
**200**  
**Sopratop**  
**Reversibile**

### ACCESSORI CONSIGLIATI

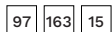

### MATERIALI E COLORI

<b>GRANITEK</b> <small>NATURAL GRANITE EFFECT</small>		Euro <b>280</b>
METAL	<b>Titanium M73</b>	LMYR6073
	<b>Aluminium M79</b>	LMYR6079
Euro <b>266</b>		
MATT	<b>Nero G40</b>	LGYR6040
	<b>Tortora G43</b>	LGYR6043
	<b>Cemento G48</b>	LGYR6048
	<b>Bianco G68</b>	LGYR6068
	<b>Espresso G78</b>	LGYR6078
Euro <b>266</b>		
CLASSIC	<b>Avena G51</b>	LGYR6051
	<b>Antracite G59</b>	LGYR6059
	<b>Bianco Antico G62</b>	LGYR6062

\*dima inclusa nella confezione o scaricabile dalla sezione download specifica del sito [www.elleci.com/it](http://www.elleci.com/it)



MAGGIORI  
INFORMAZIONI  
LINEA LIFE



**EVERYDAY LIFE**

Il classico incontra il moderno attraverso forme e linee discrete, morbide ed essenziali.  
L'estetica mette al centro la propria essenza, funzionalità concreta di ciò che è importante nell'uso quotidiano.

PLUS **LIFE**



ACCESSORI  
ELEMENT



VASCA CON  
ANGOLI  
ARROTONDATI



DESIGN  
ESSENZIALE

**GRANITEK**<sup>®</sup>  
NATURAL GRANITE EFFECT

**Titanium**  
M73

**Aluminium**  
M79

**Nero**  
G40

**Tortora**  
G43

**Cemento**  
G48

**Bianco**  
G68

**Espresso**  
G78

**Avena**  
G51

**Antracite**  
G59

**Bianco Antico**  
G62



## I MODELLI LIFE

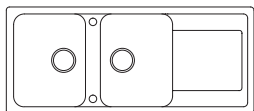

LIFE 500

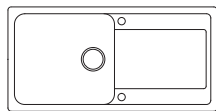

LIFE 480

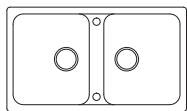

LIFE 450

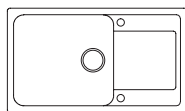

LIFE 410

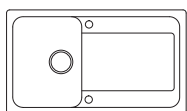

LIFE 400

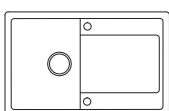

LIFE 300

**Corredo del lavello:** Sifone salvaspazio, troppopieno tondo, pilette e ganci.

## ACCESSORI CONSIGLIATI

88

**ELEMENT TAGLIERE  
SLIDING 50 CM**  
ATH010BK  
Pag. 142



### Finiture

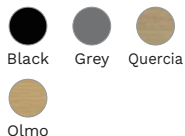

71

**BOTTOM GRID S**  
AGB01306  
Pag. 150



## IL PERFETTO MATCH MISCELATORI



**TRAIL PLUS - Cromato CR**  
MIKTRPCR

Pag. 159

Disponibile nelle colorazioni

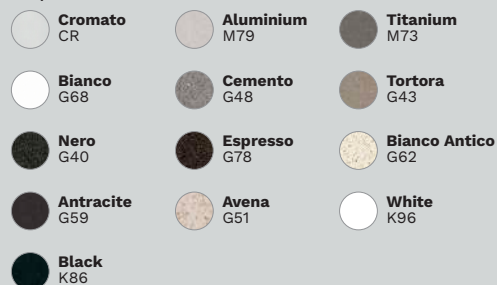

## OPTIONAL



KIT ELEMENT  
**ELEMENT DISPENSER SAPONE TONDO**  
ADIO2300

Pag. 145

## elleci | BEAUTY



Una linea di prodotti appositamente studiata per la cura dei lavelli in composito.

Scopri di più a pag. 200

\*Per ulteriori informazioni vai alla sezione accessori a pag. 140

# LIFE 500 NEW



Bianco  
G68

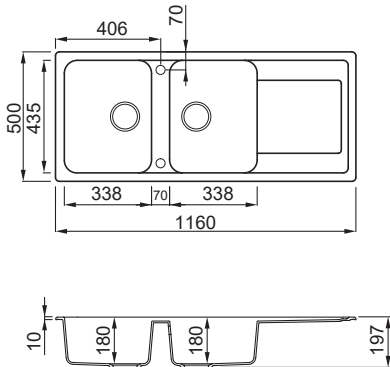

Lavello 2 vasche con gocciolatoio

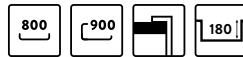

### CARATTERISTICHE

Dimensioni (mm) **1160 x 500**  
 Base (mm) **800 ||| 900 se inizio composizione**  
 Foro da incasso (mm) **1140 x 480**  
 Profondità Vasca 1 (mm) **180**  
 Profondità Vasca 2 (mm) **180**  
 Installazione **Sopratop**  
 Orientamento **Reversibile**

### MATERIALI E COLORI

		<b>GRANITEK</b> <small>NATURAL GRANITE EFFECT</small>	Euro <b>413</b>
METAL		<b>Titanium</b> M73	LM250073
		<b>Aluminium</b> M79	LM250079
			Euro <b>398</b>
MATT		<b>Nero</b> G40	LG250040
		<b>Tortora</b> G43	LG250043
		<b>Cemento</b> G48	LG250048
		<b>Bianco</b> G68	LG250068
		<b>Espresso</b> G78	LG250078
			Euro <b>398</b>
CLASSIC		<b>Avena</b> G51	LG250051
		<b>Antracite</b> G59	LG250059
		<b>Bianco Antico</b> G62	LG250062

# LIFE 480 NEW



Bianco  
G68

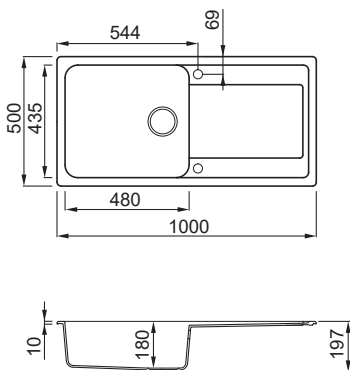

Lavello 1 vasca con gocciolatoio



### CARATTERISTICHE

Dimensioni (mm) **1000 x 500**  
 Base (mm) **600**  
 Foro da incasso (mm) **980 x 480**  
 Profondità Vasca (mm) **180**  
 Installazione **Sopratop**  
 Orientamento **Reversibile**

### MATERIALI E COLORI

		<b>GRANITEK</b> <small>NATURAL GRANITE EFFECT</small>	Euro <b>411</b>
METAL		<b>Titanium</b> M73	LM248073
		<b>Aluminium</b> M79	LM248079
			Euro <b>393</b>
MATT		<b>Nero</b> G40	LG248040
		<b>Tortora</b> G43	LG248043
		<b>Cemento</b> G48	LG248048
		<b>Bianco</b> G68	LG248068
		<b>Espresso</b> G78	LG248078
			Euro <b>393</b>
CLASSIC		<b>Avena</b> G51	LG248051
		<b>Antracite</b> G59	LG248059
		<b>Bianco Antico</b> G62	LG248062

LIFE 410 **NEW**



Cemento G48

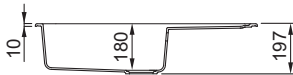
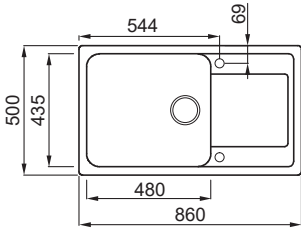

Lavello 1 vasca con gocciolatoio

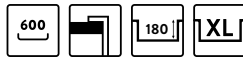

**CARATTERISTICHE**

Dimensioni (mm) **860 x 500**  
 Base (mm) **600**  
 Foro da incasso (mm) **840 x 480**  
 Profondità Vasca (mm) **180**  
 Installazione **Sopratop**  
 Orientamento **Reversibile**

**MATERIALI E COLORI**

		<b>GRANITEK</b> <small>NATURAL GRANITE EFFECT</small>	Euro <b>411</b>
METAL		<b>Titanium</b> M73	LM241073
		<b>Aluminium</b> M79	LM241079
			Euro <b>393</b>
MATT		<b>Nero</b> G40	LG241040
		<b>Tortora</b> G43	LG241043
		<b>Cemento</b> G48	LG241048
		<b>Bianco</b> G68	LG241068
		<b>Espresso</b> G78	LG241078
			Euro <b>393</b>
CLASSIC		<b>Avena</b> G51	LG241051
		<b>Antracite</b> G59	LG241059
		<b>Bianco Antico</b> G62	LG241062

LIFE 400 **NEW**



Cemento G48

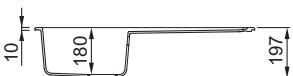
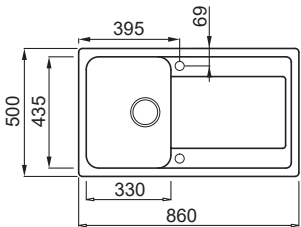

Lavello 1 vasca con gocciolatoio



**CARATTERISTICHE**

Dimensioni (mm) **860 x 500**  
 Base (mm) **450**  
 Foro da incasso (mm) **840 x 480**  
 Profondità Vasca (mm) **180**  
 Installazione **Sopratop**  
 Orientamento **Reversibile**

**MATERIALI E COLORI**

		<b>GRANITEK</b> <small>NATURAL GRANITE EFFECT</small>	Euro <b>360</b>
METAL		<b>Titanium</b> M73	LM240073
		<b>Aluminium</b> M79	LM240079
			Euro <b>348</b>
MATT		<b>Nero</b> G40	LG240040
		<b>Tortora</b> G43	LG240043
		<b>Cemento</b> G48	LG240048
		<b>Bianco</b> G68	LG240068
		<b>Espresso</b> G78	LG240078
			Euro <b>348</b>
CLASSIC		<b>Avena</b> G51	LG240051
		<b>Antracite</b> G59	LG240059
		<b>Bianco Antico</b> G62	LG240062

# LIFE 300 NEW



**Tortora**  
G43

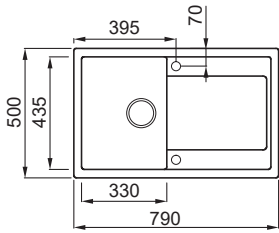

Lavello 1 vasca con gocciolatoio



### CARATTERISTICHE

Dimensioni (mm) **790 x 500**  
 Base (mm) **450**  
 Foro da incasso (mm) **770 x 480**  
 Profondità Vasca (mm) **180**  
 Installazione **Sopratop**  
 Orientamento **Reversibile**

### MATERIALI E COLORI

		<b>GRANITEK</b> <small>NATURAL GRANITE EFFECT</small>	Euro <b>360</b>
METAL		<b>Titanium</b> M73	LM230073
		<b>Aluminium</b> M79	LM230079
			Euro <b>348</b>
MATT		<b>Nero</b> G40	LG230040
		<b>Tortora</b> G43	LG230043
		<b>Cemento</b> G48	LG230048
		<b>Bianco</b> G68	LG230068
		<b>Espresso</b> G78	LG230078
			Euro <b>348</b>
CLASSIC		<b>Avena</b> G51	LG230051
		<b>Antracite</b> G59	LG230059
		<b>Bianco Antico</b> G62	LG230062

# LIFE 450 NEW



**Tortora**  
G43

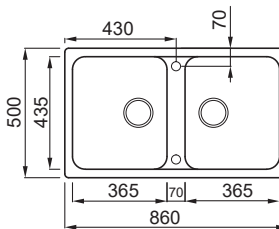

Lavello 2 vasche



### CARATTERISTICHE

Dimensioni (mm) **860 x 500**  
 Base (mm) **900**  
 Foro da incasso (mm) **840 x 480**  
 Profondità Vasca 1 (mm) **180**  
 Profondità Vasca 2 (mm) **180**  
 Installazione **Sopratop**  
 Orientamento **Reversibile**

### MATERIALI E COLORI

		<b>GRANITEK</b> <small>NATURAL GRANITE EFFECT</small>	Euro <b>381</b>
METAL		<b>Titanium</b> M73	LM245073
		<b>Aluminium</b> M79	LM245079
			Euro <b>367</b>
MATT		<b>Nero</b> G40	LG245040
		<b>Tortora</b> G43	LG245043
		<b>Cemento</b> G48	LG245048
		<b>Bianco</b> G68	LG245068
		<b>Espresso</b> G78	LG245078
			Euro <b>367</b>
CLASSIC		<b>Avena</b> G51	LG245051
		<b>Antracite</b> G59	LG245059
		<b>Bianco Antico</b> G62	LG245062



Lavello Life 480 Espresso G78 | Miscelatore Trail Cromato



MAGGIORI  
INFORMAZIONI  
LINEA FOX



### VERSATILITÀ E PRATICITÀ

Una collezione di lavelli molto versatile. Si adatta perfettamente ad ogni tipologia di spazio a disposizione sul top da cucina. Ogni modello è combinabile con numerosi accessori e molteplici colorazioni.

### PLUS FOX



VASCA CON  
ANGOLI  
ARROTONDATI



ACCESSORI  
ELEMENT

**GRANITEK**<sup>®</sup>  
NATURAL GRANITE EFFECT

● **Titanium**  
M73

● **Aluminium**  
M79

● **Nero**  
G40

○ **Bianco**  
G68

● **Avena**  
G51

● **Antracite**  
G59

● **Bianco Antico**  
G62

## I MODELLI FOX

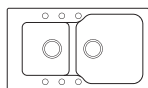

FOX 430

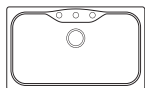

FOX 360

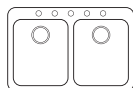

FOX 340

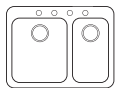

FOX 330



FOX 200

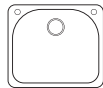

FOX 180



FOX ROUND

**Corredo del lavello:** Sifone salvaspazio, troppopieno tondo, pilette e ganci.

## ACCESSORI CONSIGLIATI

88

### ELEMENT TAGLIERE SLIDING 50 CM

ATH010QU  
Pag. 142



#### Finiture

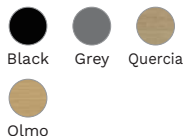

156

### ELEMENT DRAINER FLEX 500

ARS023BK  
Pag. 144



#### Finiture



155

### ELEMENT TAGLIERE FOX 360

ATH130OL  
Pag. 143



#### Finiture



11

### CESTELLO FOX 360

ACI03300  
Pag. 151



\*Per ulteriori informazioni vai alla sezione accessori a pag. 140

## IL PERFETTO MATCH MISCELATORI



### CHEF - Cromato CR MIKCHECR

Pag. 156

Disponibile nelle colorazioni

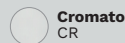

## OPTIONAL



KIT ELEMENT

### ELEMENT DISPENSER SAPONE TONDO ADIO2300

Pag. 145

## elleci | BEAUTY



Una linea di prodotti appositamente studiata per la cura dei lavelli in composito.

Scopri di più a pag. 200

# FOX 360



**Avena G51**

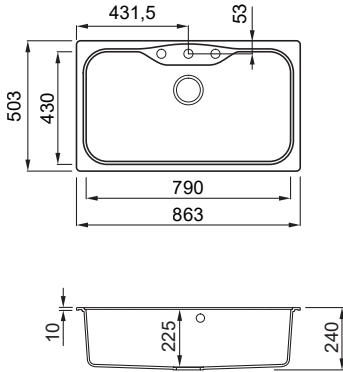

Lavello 1 vasca

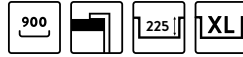

### CARATTERISTICHE

Dimensioni (mm)	<b>863 x 503</b>
Base (mm)	<b>900</b>
Foro da incasso (mm)	<b>840 x 490</b>
Profondità Vasca (mm)	<b>225</b>
Installazione	<b>Sopratop</b>
Orientamento	<b>Non reversibile</b>

### ACCESSORI CONSIGLIATI

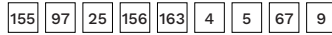

### MATERIALI E COLORI

		<b>GRANITEK</b> NATURAL GRANITE EFFECT	Euro <b>432</b>
METAL		<b>Titanium M73</b>	LMF36073
		<b>Aluminium M79</b>	LMF36079
			Euro <b>412</b>
MATT		<b>Nero G40</b>	LGF36040
		<b>Bianco G68</b>	LGF36068
			Euro <b>412</b>
CLASSIC		<b>Avena G51</b>	LGF36051
		<b>Antracite G59</b>	LGF36059
		<b>Bianco Antico G62</b>	LGF36062

# FOX 200



**Bianco Antico G62**

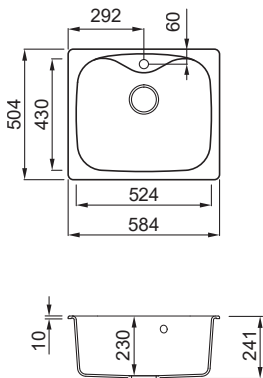

Lavello 1 vasca



### CARATTERISTICHE

Dimensioni (mm)	<b>584 x 504</b>
Base (mm)	<b>600</b>
Foro da incasso (mm)	<b>560 x 480 R32</b>
Profondità Vasca (mm)	<b>230</b>
Installazione	<b>Sopratop</b>
Orientamento	<b>Non reversibile</b>

### ACCESSORI CONSIGLIATI

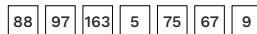

### MATERIALI E COLORI

		<b>GRANITEK</b> NATURAL GRANITE EFFECT	Euro <b>394</b>
METAL		<b>Titanium M73</b>	LMF20073
		<b>Aluminium M79</b>	LMF20079
			Euro <b>371</b>
MATT		<b>Nero G40</b>	LGF20040
		<b>Bianco G68</b>	LGF20068
			Euro <b>371</b>
CLASSIC		<b>Avena G51</b>	LGF20051
		<b>Antracite G59</b>	LGF20059
		<b>Bianco Antico G62</b>	LGF20062

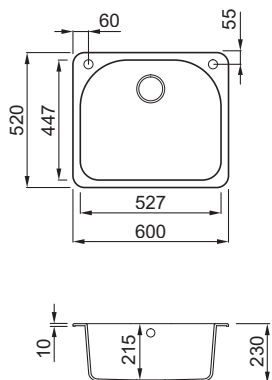

## FOX 180

Avena  
G51

## Lavello 1 vasca

**CARATTERISTICHE**

Dimensioni (mm)	<b>600 x 520</b>
Base (mm)	<b>600</b>
Foro da incasso (mm)	<b>580 x 510 R32</b>
Profondità Vasca (mm)	<b>215</b>
Installazione	<b>Sopratop</b>
Orientamento	<b>Non reversibile</b>

**ACCESSORI CONSIGLIATI****MATERIALI E COLORI****GRANITEK**  
NATURAL GRANITE EFFECT

MATT

Euro **407**  
LGF18040BTP  
LGF18068BTP

CLASSIC

Euro **407**  
LGF18051BTP  
LGF18059BTP  
LGF18062BTP

## FOX ROUND

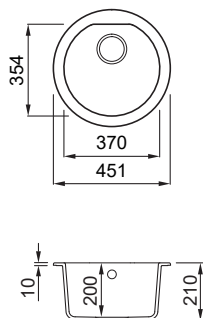
Avena  
G51

## Lavello 1 vasca

**CARATTERISTICHE**

Dimensioni (mm)	<b>Ø 451</b>
Base (mm)	<b>450</b>
Foro da incasso (mm)	<b>Ø 430</b>
Profondità Vasca (mm)	<b>200</b>
Installazione	<b>Sopratop</b>
Orientamento	<b>Non reversibile</b>

**ACCESSORI CONSIGLIATI****MATERIALI E COLORI****GRANITEK**  
NATURAL GRANITE EFFECT

MATT

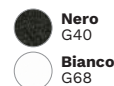
Euro **302**  
LGFROU40  
LGFROU68

CLASSIC

Euro **302**  
LGFROU51  
LGFROU59  
LGFROU62

## FOX 430



Bianco  
G68

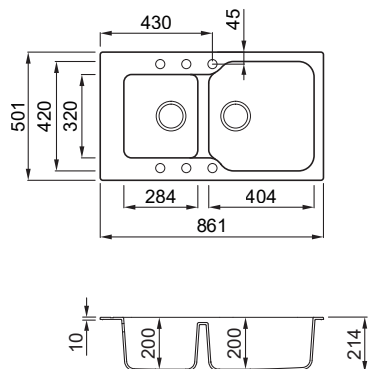

Lavello 2 vasche

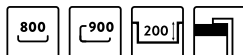

### CARATTERISTICHE

Dimensioni (mm)	<b>861 x 501</b>
Base (mm)	<b>800     900 se inizio composizione</b>
Foro da incasso (mm)	<b>840 x 490</b>
Profondità Vasca 1 (mm)	<b>200</b>
Profondità Vasca 2 (mm)	<b>200</b>
Installazione	<b>Sopratop</b>
Orientamento	<b>Reversibile</b>

### ACCESSORI CONSIGLIATI

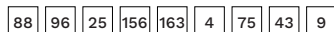

### MATERIALI E COLORI

MATT		<b>Nero</b> G40	Euro <b>407</b> LGF43040
		<b>Bianco</b> G68	LGF43068
	Euro <b>407</b>		
CLASSIC		<b>Avena</b> G51	LGF43051
		<b>Antracite</b> G59	LGF43059
		<b>Bianco Antico</b> G62	LGF43062

## FOX 340



Bianco  
G68

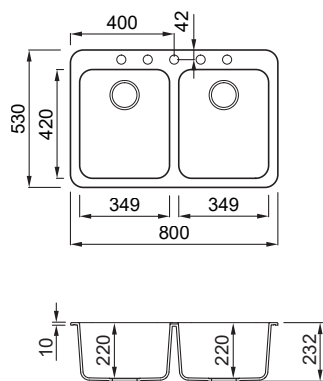

Lavello 2 vasche



### CARATTERISTICHE

Dimensioni (mm)	<b>800 x 530</b>
Base (mm)	<b>800     900 se inizio composizione</b>
Foro da incasso (mm)	<b>780 x 520 R32</b>
Profondità Vasca 1 (mm)	<b>220</b>
Profondità Vasca 2 (mm)	<b>220</b>
Installazione	<b>Sopratop</b>
Orientamento	<b>Non reversibile</b>

### ACCESSORI CONSIGLIATI

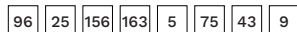

### MATERIALI E COLORI

MATT		<b>Nero</b> G40	Euro <b>394</b> LGF34040BTP
		<b>Bianco</b> G68	LGF34068BTP
	Euro <b>394</b>		
CLASSIC		<b>Avena</b> G51	LGF34051BTP
		<b>Antracite</b> G59	LGF34059BTP
		<b>Bianco Antico</b> G62	LGF34062BTP

FOX 330



Nero G40

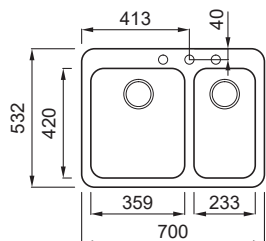

Lavello 2 vasche



**CARATTERISTICHE**

Dimensioni (mm)	<b>700 x 532</b>
Base (mm)	<b>800</b>
Foro da incasso (mm)	<b>680 x 520 R32</b>
Profondità Vasca 1 (mm)	<b>230</b>
Profondità Vasca 2 (mm)	<b>200</b>
Installazione	<b>Sopratop</b>
Orientamento	<b>Non reversibile</b>

**ACCESSORI CONSIGLIATI**

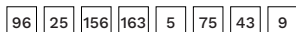

**MATERIALI E COLORI**

**GRANITEK**  
NATURAL GRANITE EFFECT

MATT



Euro **376**  
LGF33040BTP  
LGF33068BTP

CLASSIC



Euro **376**  
LGF33051BTP  
LGF33059BTP  
LGF33062BTP



Lavello Fox 360 Avena G51 | Miscelatore Reno Avena G51 | Tagliere Fox 360 Quercia



MAGGIORI  
INFORMAZIONI  
LINEA MASTER



**LO STILE COUNTRY SENZA TEMPO**

Una collezione di lavelli dal design country, perfetto per chi preferisce un ambiente caldo e classico ma con una forte personalità. Ogni modello è combinabile con numerosi accessori e molteplici colorazioni.

**PLUS MASTER**







VASCA CON  
ANGOLI  
ARROTONDATI



ACCESSORI  
ELEMENT

**GRANITEK**<sup>®</sup>  
NATURAL GRANITE EFFECT

-  **Nero**  
G40
-  **Bianco**  
G68
-  **Avena**  
G51
-  **Antracite**  
G59
-  **Bianco Antico**  
G62

## I MODELLI MASTER

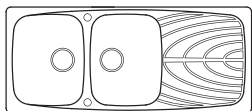

MASTER 500

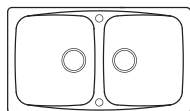

MASTER 450

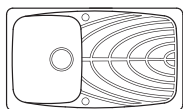

MASTER 400

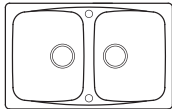

MASTER 350

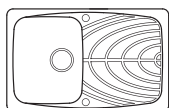

MASTER 300

**Corredo del lavello:** Sifone salvaspazio, troppopieno tondo, pilette e ganci.

## ACCESSORI CONSIGLIATI

88

### ELEMENT TAGLIERE SLIDING 50 CM

ATH010QU  
Pag. 142



#### Finiture

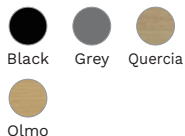

156

### ELEMENT DRAINER FLEX 500

ARS023BK  
Pag. 144

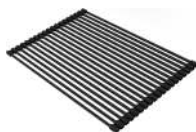

#### Finiture



5

### COLANDER

AVI03001  
Pag. 150



75

### CESTELLO

ACI01307  
Pag. 151



\*Per ulteriori informazioni vai alla sezione accessori a pag. 140

## IL PERFETTO MATCH

### MISCELATORI



### DANUBIO - Bianco G68 MGKDAN68

Pag. 165

Disponibile nelle colorazioni



## OPTIONAL



### KIT ELEMENT ELEMENT POP UP PUSH CONTROL ASP23002

Pag. 147

## elleci | BEAUTY



Una linea di prodotti appositamente studiata per la cura dei lavelli in composito.

Scopri di più a pag. 200

## MASTER 500



Avena  
G51

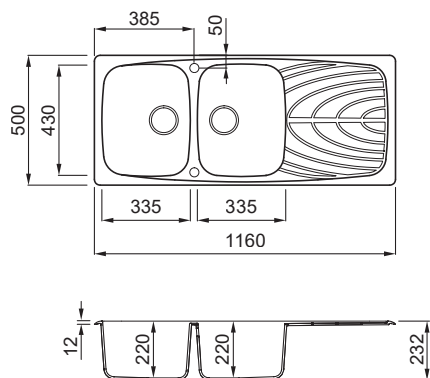

Lavello 2 vasche con gocciolatoio



### CARATTERISTICHE

Dimensioni (mm)	<b>1160 x 500</b>
Base (mm)	<b>800</b>
Foro da incasso (mm)	<b>1140 x 480</b>
Profondità Vasca 1 (mm)	<b>220</b>
Profondità Vasca 2 (mm)	<b>220</b>
Installazione	<b>Sopratop</b>
Orientamento	<b>Reversibile</b>

### ACCESSORI CONSIGLIATI

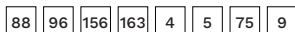

### MATERIALI E COLORI

MATT	<b>Nero</b> G40	Euro <b>428</b> LGM50040
	<b>Bianco</b> G68	LGM50068
CLASSIC	<b>Avena</b> G51	Euro <b>428</b> LGM50051
	<b>Antracite</b> G59	LGM50059
	<b>Bianco Antico</b> G62	LGM50062

## MASTER 400



Avena  
G51

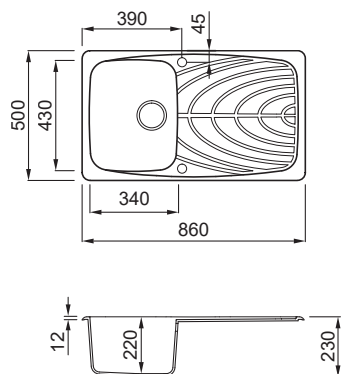

Lavello 1 vasca con gocciolatoio



### CARATTERISTICHE

Dimensioni (mm)	<b>860 x 500</b>
Base (mm)	<b>450</b>
Foro da incasso (mm)	<b>840 x 480</b>
Profondità Vasca (mm)	<b>220</b>
Installazione	<b>Sopratop</b>
Orientamento	<b>Reversibile</b>

### ACCESSORI CONSIGLIATI

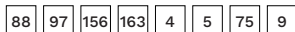

### MATERIALI E COLORI

MATT	<b>Nero</b> G40	Euro <b>371</b> LGM40040
	<b>Bianco</b> G68	LGM40068
CLASSIC	<b>Avena</b> G51	Euro <b>371</b> LGM40051
	<b>Antracite</b> G59	LGM40059
	<b>Bianco Antico</b> G62	LGM40062

## MASTER 300



Nero  
G40

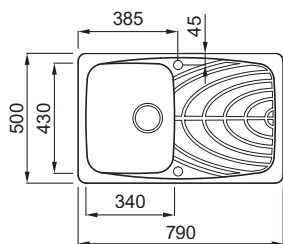

Lavello 1 vasca con gocciolatoio



### CARATTERISTICHE

Dimensioni (mm)	<b>790 x 500</b>
Base (mm)	<b>450</b>
Foro da incasso (mm)	<b>770 x 480</b>
Profondità Vasca (mm)	<b>220</b>
Installazione	<b>Sopratop</b>
Orientamento	<b>Reversibile</b>

### ACCESSORI CONSIGLIATI

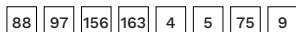

### MATERIALI E COLORI

**GRANITEK**  
NATURAL GRANITE EFFECT

MATT



Euro **371**  
LGM30040  
LGM30068

CLASSIC



Euro **371**  
LGM30051  
LGM30059  
LGM30062

## MASTER 450



Nero  
G40

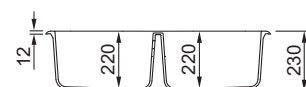
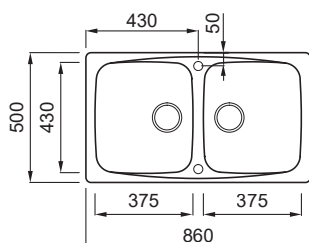

Lavello 2 vasche



### CARATTERISTICHE

Dimensioni (mm)	<b>860 x 500</b>
Base (mm)	<b>900</b>
Foro da incasso (mm)	<b>840 x 480</b>
Profondità Vasca 1 (mm)	<b>220</b>
Profondità Vasca 2 (mm)	<b>220</b>
Installazione	<b>Sopratop</b>
Orientamento	<b>Reversibile</b>

### ACCESSORI CONSIGLIATI

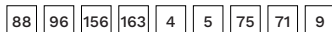

### MATERIALI E COLORI

**GRANITEK**  
NATURAL GRANITE EFFECT

MATT



Euro **394**  
LGM45040  
LGM45068

CLASSIC



Euro **394**  
LGM45051  
LGM45059  
LGM45062

# MASTER 350



Avena  
G51

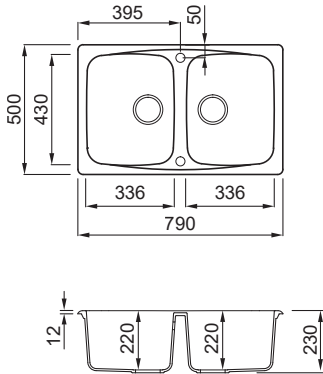

## Lavello 2 vasche

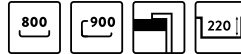

### CARATTERISTICHE

Dimensioni (mm)	<b>790 x 500</b>
Base (mm)	<b>800     900 se inizio composizione</b>
Foro da incasso (mm)	<b>770 x 480</b>
Profondità Vasca 1 (mm)	<b>220</b>
Profondità Vasca 2 (mm)	<b>220</b>
Installazione	<b>Sopratop</b>
Orientamento	<b>Reversibile</b>

### ACCESSORI CONSIGLIATI

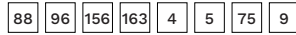

## MATERIALI E COLORI

**GRANITEK**  
NATURAL GRANITE EFFECT

MATT



Euro **394**  
LGM35040  
LGM35068

CLASSIC

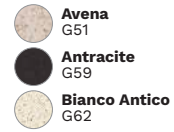

Euro **394**  
LGM35051  
LGM35059  
LGM35062





Lavello Master 500 Avena G51 | Miscelatore Danubio Avena G51

COLLEZIONE  
**LAVELLI  
INOX**

**2 ANNI - YEARS  
WARRANTY  
GARANTITO**

**CONFIGURA IL TUO LAVELLO INOX**

Scegli tra collezione, tipologie e accessori per configurare il tuo lavello da cucina ideale.

**SATINATA**

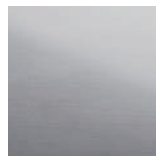

Opaco ma lucente, l'acciaio satinato conserva per anni, inalterati, i suoi valori di eleganza, igiene e resistenza all'usura dell'utilizzo quotidiano.



DISEGNI TECNICI  
APPROFONDITI  
**GAMMA INOX**

COLLEZIONE

**COMPASS** NEW

La linea Compass si caratterizza per il Banco Rubinetteria integrato e per le sue linee minimal. Vasche singole in diverse dimensioni, versatili e pratiche, apportano funzionalità in cucina. Collezione Compass in acciaio inox AISI 304 18/10.



FLAT



FILOTOP



PROFONDITÀ  
VASCA  
200 MM



MUNITO DI FORO  
MISCELATORE

COLLEZIONE

**ESPRIT** NEW

Una serie di eleganti e funzionali vasche dal raggio interno minimo (12 mm), installabile in 3 modalità.

Semifilo: in appoggio sul piano di lavoro.

Filotop: con inserimento in un alloggiamento profondo 1 mm ricavato sul top.

Sottotop: sotto il piano di lavoro.

Collezione Esprit in acciaio inox AISI 304 18/10.



FLAT



FILOTOP



SOTTOTOP



PROFONDITÀ  
VASCA  
200 MM

COLLEZIONE

**W-SQUARE**

Vasche profonde ed alti spessori. Lavelli con raggio interno minimo (12 mm) e piletta quadrata dall'estetica ancora più accattivante.

Collezione W-Square con piletta quadrata, semifilo, filotop e sottotop in acciaio inox AISI 304 18/10.



FLAT



FILOTOP



SOTTOTOP



PROFONDITÀ  
VASCA  
200 MM



PILETTA  
QUADRATA

COLLEZIONE

**SKY**

Per tutto il pianeta cucine. Design puro e semplice che trova posto in tutti i tipi di arredamento.

Collezione Sky da incasso in acciaio inox AISI 304 18/10.



SOPRATOP



PROFONDITÀ  
VASCA  
205 - 160 MM



MUNITO DI FORO  
MISCELATORE

COMPASS 700 **NEW**



Satinato  
ST

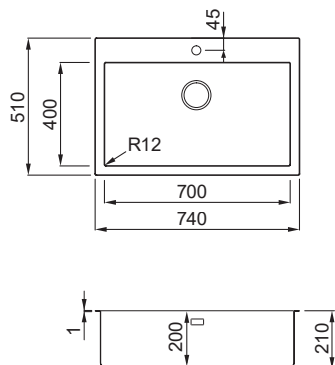

Lavello 1 vasca in acciaio inox satinato AISI 304 spessore 10/10



**CARATTERISTICHE**

Dimensioni (mm)	<b>740 x 510</b>
Raggio vasca (mm)	<b>12</b>
Base (mm)	<b>800</b>
Foro da incasso (mm)	<b>730 x 495 R10 (Flat), 730 x 495 (Filotop)</b>
Profondità Vasca (mm)	<b>200</b>
Installazione	<b>Flat, Filotop</b>
Orientamento	<b>Non reversibile</b>

**Banco rubinetteria a bordo**

**ACCESSORI CONSIGLIATI**

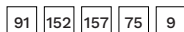

**Corredo del lavello:** Sifone salvaspazio, pilette, troppopieno e ganci fissaggio.

**MATERIALI E COLORI**

**INOX**



Satinato  
ST

Euro **616**  
LIM700SAC

COMPASS 500 **NEW**



Satinato  
ST

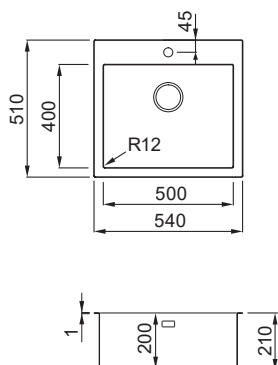

Lavello 1 vasca in acciaio inox satinato AISI 304 spessore 10/10



**CARATTERISTICHE**

Dimensioni (mm)	<b>540 x 510</b>
Raggio vasca (mm)	<b>12</b>
Base (mm)	<b>600</b>
Foro da incasso (mm)	<b>530 x 495 R10 (Flat), 530 x 495 (Filotop)</b>
Profondità Vasca (mm)	<b>200</b>
Installazione	<b>Flat, Filotop</b>
Orientamento	<b>Non reversibile</b>

**Banco rubinetteria a bordo**

**ACCESSORI CONSIGLIATI**

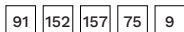

**Corredo del lavello:** Sifone salvaspazio, pilette, troppopieno e ganci fissaggio.

**MATERIALI E COLORI**

**INOX**



Satinato  
ST

Euro **578**  
LIM500SAC

# COMPASS 400 NEW



Satinato  
ST

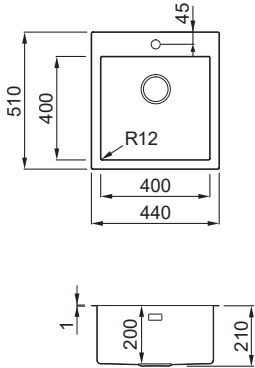

Lavello 1 vasca in acciaio inox satinato AISI 304 spessore 10/10



### CARATTERISTICHE

Dimensioni (mm)	<b>440 x 510</b>
Raggio vasca (mm)	<b>12</b>
Base (mm)	<b>450 (Flat), 600 (Filotop)</b>
Foro da incasso (mm)	<b>430 x 495 R10 (Flat), 430 x 495 (Filotop)</b>
Profondità Vasca (mm)	<b>200</b>
Installazione	<b>Flat, Filotop</b>
Orientamento	<b>Non reversibile</b>

**Banco rubinetteria a bordo**

### ACCESSORI CONSIGLIATI



**Corredo del lavello:** Sifone salvaspazio, pilette, troppopieno e ganci fissaggio.

## ACCESSORI LAVELLI INOX

### COMPASS

91

#### ELEMENT TAGLIERE 420

ATH040OL  
Euro **128**

Pag. **143**



152

#### ELEMENT COLANDER 418

AVP035BK  
Euro **67**

Pag. **145**



157

#### ELEMENT DRAINER FLEX 440

ARS013BK  
Euro **83**

Pag. **144**

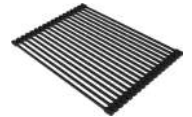

75

#### CESTELLO

ACI01307  
Euro **105**

Pag. **151**



### SKY (Escluso Sky Round 435)

88

#### ELEMENT TAGLIERE SLIDING 50 CM

ATH010BK  
Euro **153**

Pag. **142**



156

#### ELEMENT DRAINER FLEX 500

ARS023BK  
Euro **92**

Pag. **144**



ESPRIT **700** **NEW**



Satinato  
ST

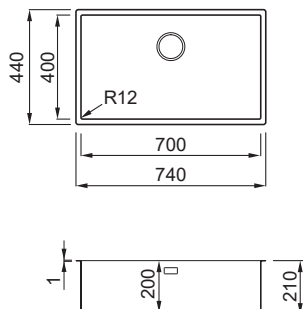

Lavello 1 vasca in acciaio inox satinato AISI 304 spessore 10/10



**CARATTERISTICHE**

Dimensioni (mm)	<b>740 x 440</b>
Raggio vasca (mm)	<b>12</b>
Base (mm)	<b>800</b>
Foro da incasso (mm)	<b>730 x 430 R10 (Flat), 701 x 401 R13 (Sottotop), 730 x 430 (Filotop)</b>
Profondità Vasca (mm)	<b>200</b>
Installazione	<b>Flat, Filotop, Sottotop</b>
Orientamento	<b>Non reversibile</b>

**ACCESSORI CONSIGLIATI**

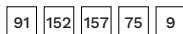

**Corredo del lavello:** Sifone salvaspazio, pilette, troppopieno e ganci fissaggio.

**MATERIALI E COLORI**

**INOX**



Satinato  
ST

Euro **508**  
LIE700SAC

ESPRIT **500** **NEW**



Satinato  
ST

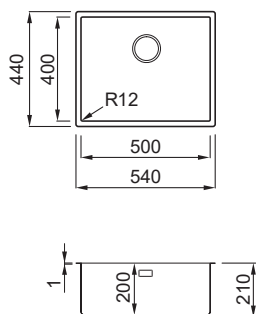

Lavello 1 vasca in acciaio inox satinato AISI 304 spessore 10/10



**CARATTERISTICHE**

Dimensioni (mm)	<b>540 x 440</b>
Raggio vasca (mm)	<b>12</b>
Base (mm)	<b>600</b>
Foro da incasso (mm)	<b>530 x 430 R10 (Flat), 501 x 401 R13 (Sottotop), 530 x 430 (Filotop)</b>
Profondità Vasca (mm)	<b>200</b>
Installazione	<b>Flat, Filotop, Sottotop</b>
Orientamento	<b>Non reversibile</b>

**ACCESSORI CONSIGLIATI**

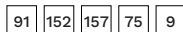

**Corredo del lavello:** Sifone salvaspazio, pilette, troppopieno e ganci fissaggio.

**MATERIALI E COLORI**

**INOX**



Satinato  
ST

Euro **448**  
LIE500SAC

# ESPRIT 400 NEW



Satinato  
ST

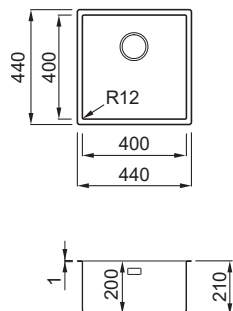

Lavello 1 vasca in acciaio inox satinato AISI 304 spessore 10/10



### CARATTERISTICHE

Dimensioni (mm)	<b>440 x 440</b>
Raggio vasca (mm)	<b>12</b>
Base (mm)	<b>450 (Flat, Sottotop), 600 (Filotop)</b>
Foro da incasso (mm)	<b>430 x 430 R10 (Flat), 401 x 401 R13 (Sottotop), 430 x 430 (Filotop)</b>
Profondità Vasca (mm)	<b>200</b>
Installazione	<b>Flat, Filotop, Sottotop</b>
Orientamento	<b>Non reversibile</b>

### ACCESSORI CONSIGLIATI

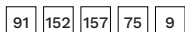

**Corredo del lavello:** Sifone salvaspazio, pilette, troppopieno e ganci fissaggio.

## ACCESSORI LAVELLI INOX

ESPRIT

91  
**ELEMENT  
TAGLIERE 420**  
ATH040OL  
Euro **128**  
Pag. **143**



152  
**ELEMENT  
COLANDER 418**  
AVP035BK  
Euro **67**  
Pag. **145**



157  
**ELEMENT DRAINER  
FLEX 440**  
ARS013BK  
Euro **83**  
Pag. **144**

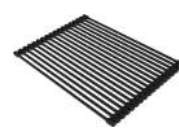

75  
**CESTELLO**  
ACI01307  
Euro **105**  
Pag. **151**



**SKY (Escluso Sky Round 435)**  
88  
**ELEMENT TAGLIERE  
SLIDING 50 CM**  
ATH010QU  
Euro **153**  
Pag. **142**



156  
**ELEMENT DRAINER  
FLEX 500**  
ARS023BK  
Euro **92**  
Pag. **144**



## W-SQUARE 700



Satinato  
ST

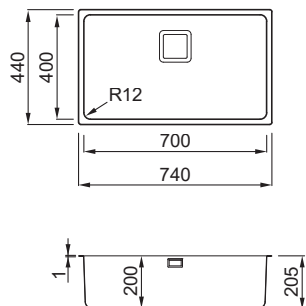

Lavello 1 vasca in acciaio inox satinato AISI 304 spessore 10/10



### CARATTERISTICHE

Dimensioni (mm)	<b>740 x 440</b>
Raggio vasca (mm)	<b>12</b>
Base (mm)	<b>800</b>
Foro da incasso (mm)	<b>730 x 430 R10 (Flat), 701 x 401 R13 (Sottotop), 730 x 430 (Filotop)</b>
Profondità Vasca (mm)	<b>200</b>
Installazione	<b>Flat, Filotop, Sottotop</b>
Orientamento	<b>Non reversibile</b>

### ACCESSORI CONSIGLIATI

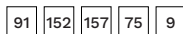

**Corredo del lavello:** Sifone salvaspazio, pilette, troppopieno e ganci fissaggio.

## W-SQUARE 500



Satinato  
ST

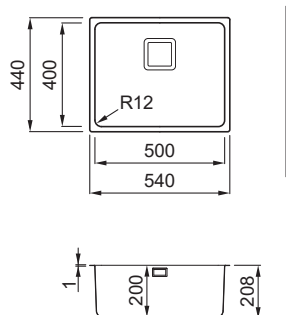

Lavello 1 vasca in acciaio inox satinato AISI 304 spessore 10/10



### CARATTERISTICHE

Dimensioni (mm)	<b>540 x 440</b>
Raggio vasca (mm)	<b>12</b>
Base (mm)	<b>600</b>
Foro da incasso (mm)	<b>530 x 430 R10 (Flat), 501 x 401 R13 (Sottotop), 530 x 430 (Filotop)</b>
Profondità Vasca (mm)	<b>200</b>
Installazione	<b>Flat, Filotop, Sottotop</b>
Orientamento	<b>Non reversibile</b>

### ACCESSORI CONSIGLIATI

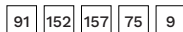

**Corredo del lavello:** Sifone salvaspazio, pilette, troppopieno e ganci fissaggio.

### MATERIALI E COLORI

**INOX**



Euro **506**

LIW700SACMU

### MATERIALI E COLORI

**INOX**



Euro **418**

LIW500SACMU

# W-SQUARE 400



Satinato  
ST

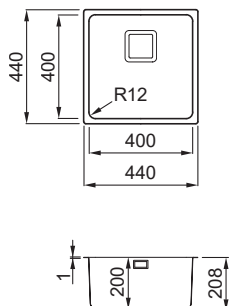

Lavello 1 vasca in acciaio inox satinato AISI 304 spessore 10/10



## CARATTERISTICHE

Dimensioni (mm)	<b>440 x 440</b>
Raggio vasca (mm)	<b>12</b>
Base (mm)	<b>450 (Flat, Sottotop), 600 (Filotop)</b>
Foro da incasso (mm)	<b>430 x 430 R10 (Flat), 401 x 401 R13 (Sottotop), 430 x 430 (Filotop)</b>
Profondità Vasca (mm)	<b>200</b>
Installazione	<b>Flat, Filotop, Sottotop</b>
Orientamento	<b>Non reversibile</b>

## ACCESSORI CONSIGLIATI

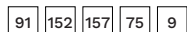

**Corredo del lavello:** Sifone salvaspazio, pilette, troppopieno e ganci fissaggio.

## ACCESSORI LAVELLI INOX

### W-SQUARE

91

#### ELEMENT TAGLIERE 420

ATH040OL  
Euro **128**

Pag. **143**



152

#### ELEMENT COLANDER 418

AVP035BK  
Euro **67**

Pag. **145**



157

#### ELEMENT DRAINER FLEX 440

ARS013BK  
Euro **83**

Pag. **144**

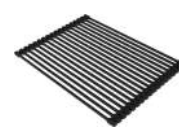

75

#### CESTELLO

ACI01307  
Euro **105**

Pag. **151**



### SKY (Escluso Sky Round 435)

88

#### ELEMENT TAGLIERE SLIDING 50 CM

ATH010QU  
Euro **153**

Pag. **142**



156

#### ELEMENT DRAINER FLEX 500

ARS023BK  
Euro **92**

Pag. **144**





## SKY 500



Satinato  
ST

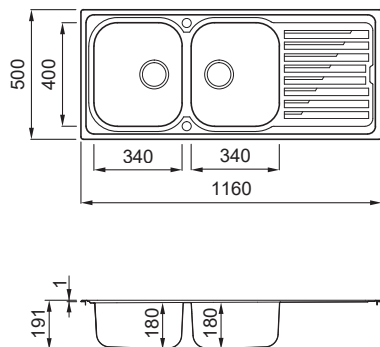

Lavello in acciaio inox satinato AISI 304 spessore 6/10 2 vasche con gocciolatoio



### CARATTERISTICHE

Dimensioni (mm)	<b>1160 x 500</b>
Base (mm)	<b>800</b>
Foro da incasso (mm)	<b>1140 x 480</b>
Profondità Vasca 1 (mm)	<b>180</b>
Profondità Vasca 2 (mm)	<b>180</b>
Installazione	<b>Sopratop</b>
Orientamento	<b>Non reversibile</b>

**Banco rubinetteria a bordo**

### ACCESSORI CONSIGLIATI



**Corredo del lavello:** Sifone salvaspazio, pilette, troppopieno e ganci fissaggio.

## SKY 480



Satinato  
ST

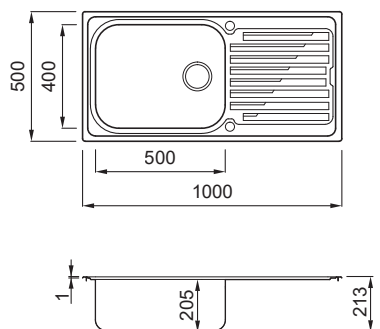

Lavello in acciaio inox satinato AISI 304 spessore 6/10 1 vasca con gocciolatoio



### CARATTERISTICHE

Dimensioni (mm)	<b>1000 x 500</b>
Base (mm)	<b>600</b>
Foro da incasso (mm)	<b>980 x 480</b>
Profondità Vasca (mm)	<b>205</b>
Installazione	<b>Sopratop</b>
Orientamento	<b>Non reversibile</b>

**Banco rubinetteria a bordo**

### ACCESSORI CONSIGLIATI



**Corredo del lavello:** Sifone salvaspazio, pilette, troppopieno e ganci fissaggio.

### MATERIALI E COLORI

#### INOX



Euro **312**  
LIK500SACDX  
LIK500SACSX

### MATERIALI E COLORI

#### INOX



Euro **304**  
LIK480SACDX  
LIK480SACSX

## SKY 400



Satinato  
ST

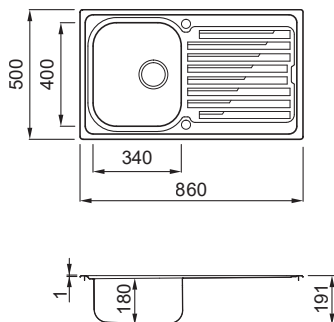

Lavello in acciaio inox satinato AISI 304  
spessore 6/10 1 vasca con gocciolatoio



### CARATTERISTICHE

Dimensioni (mm)	<b>860 x 500</b>
Base (mm)	<b>450</b>
Foro da incasso (mm)	<b>840 x 480</b>
Profondità Vasca (mm)	<b>180</b>
Installazione	<b>Sopratop</b>
Orientamento	<b>Non reversibile</b>

**Banco rubinetteria a bordo**

### ACCESSORI CONSIGLIATI



**Corredo del lavello:** Sifone salvaspazio, pilette, troppopieno e ganci fissaggio.

## SKY 125



Satinato  
ST

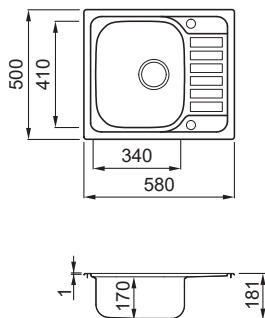

Lavello in acciaio inox satinato AISI 304  
spessore 6/10 1 vasca con gocciolatoio



### CARATTERISTICHE

Dimensioni (mm)	<b>580 x 500</b>
Base (mm)	<b>450</b>
Foro da incasso (mm)	<b>560 x 480</b>
Profondità Vasca (mm)	<b>170</b>
Installazione	<b>Sopratop</b>
Orientamento	<b>Non reversibile</b>

**Banco rubinetteria a bordo**

### ACCESSORI CONSIGLIATI

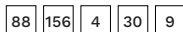

**Corredo del lavello:** Sifone salvaspazio, pilette, troppopieno e ganci fissaggio.

### MATERIALI E COLORI

#### INOX



Euro **232**  
LIK400SACDX  
LIK400SACSX

### MATERIALI E COLORI

#### INOX



Euro **126**  
LIX125SACDX  
LIX125SACSX

## SKY 360



Satinato  
ST

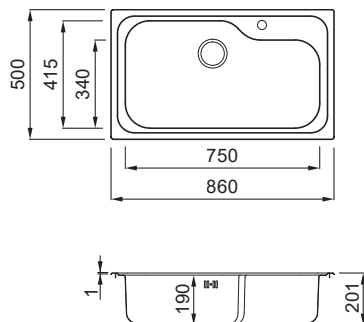

Lavello 1 vasca in acciaio inox satinato AISI 304 spessore 6/10



### CARATTERISTICHE

Dimensioni (mm)	<b>860 x 500</b>
Base (mm)	<b>900</b>
Foro da incasso (mm)	<b>840 x 480</b>
Profondità Vasca (mm)	<b>190</b>
Installazione	<b>Sopratop</b>
Orientamento	<b>Non reversibile</b>

**Banco rubinetteria a bordo**

### ACCESSORI CONSIGLIATI



**Corredo del lavello:** Sifone salvaspazio, pilette, troppopieno e ganci fissaggio.

## SKY 450



Satinato  
ST

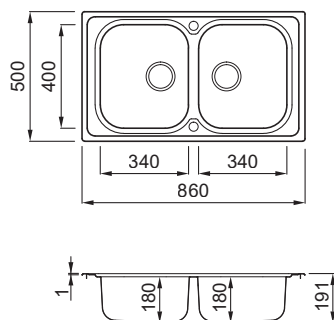

Lavello 2 vasche in acciaio inox satinato AISI 304 spessore 6/10



### CARATTERISTICHE

Dimensioni (mm)	<b>860 x 500</b>
Base (mm)	<b>800     900 se inizio composizione</b>
Foro da incasso (mm)	<b>840 x 480</b>
Profondità Vasca 1 (mm)	<b>180</b>
Profondità Vasca 2 (mm)	<b>180</b>
Installazione	<b>Sopratop</b>
Orientamento	<b>Reversibile</b>

**Banco rubinetteria a bordo**

### ACCESSORI CONSIGLIATI



**Corredo del lavello:** Sifone salvaspazio, pilette, troppopieno e ganci fissaggio.

### MATERIALI E COLORI

**INOX**



Satinato  
ST

Euro **377**  
LIK360SAC

### MATERIALI E COLORI

**INOX**



Satinato  
ST

Euro **282**  
LIK450SAC

## SKY 435 ROUND



Satinato  
ST

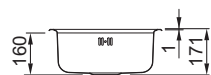
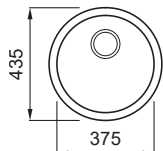

Lavello 1 vasca in acciaio inox satinato AISI 304 spessore 6/10



### CARATTERISTICHE

Dimensioni (mm)	<b>Ø 435</b>
Base (mm)	<b>450</b>
Foro da incasso (mm)	<b>Ø 415</b>
Profondità Vasca (mm)	<b>160</b>
Installazione	<b>Sopratop</b>
Orientamento	<b>Non reversibile</b>

### ACCESSORI CONSIGLIATI

15

**Corredo del lavello:** Sifone salvaspazio, pilette, troppopieno e ganci fissaggio.

### MATERIALI E COLORI

**INOX**



Euro **117**  
LIKROUSAC

## SKY CORNER



Satinato  
ST

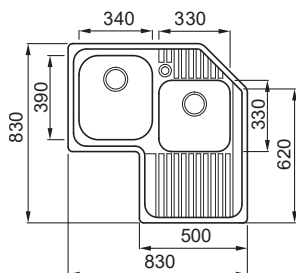

Lavello angolare in acciaio inox satinato AISI 304 spessore 6/10 2 vasche con gocciolatoio



### CARATTERISTICHE

Dimensioni (mm)	<b>830 x 830</b>
Base (mm)	<b>Corner</b>
Foro da incasso (mm)	<b>Da dima*</b>
Profondità Vasca 1 (mm)	<b>210</b>
Profondità Vasca 2 (mm)	<b>200</b>
Installazione	<b>Sopratop</b>
Orientamento	<b>Non reversibile</b>

### ACCESSORI CONSIGLIATI

88 156 4 30 9

**Corredo del lavello:** Sifone salvaspazio, pilette, troppopieno e ganci fissaggio.

\*dima inclusa nella confezione o scaricabile dalla sezione download specifica del sito [www.elleci.com/it](http://www.elleci.com/it)

### MATERIALI E COLORI

**INOX**



Euro **782**  
LIKORSACDX



LIKORSACSX

# ACCESSORI LAVELLI INOX

SKY

91  
**ELEMENT  
 TAGLIERE 420**  
 ATH040OL  
 Euro **128**  
 Pag. **143**



152  
**ELEMENT  
 COLANDER 418**  
 AVP035BK  
 Euro **67**  
 Pag. **145**



157  
**ELEMENT DRAINER  
 FLEX 440**  
 ARS013BK  
 Euro **83**  
 Pag. **144**

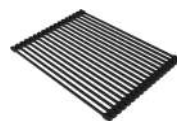

75  
**CESTELLO**  
 ACI01307  
 Euro **105**  
 Pag. **151**



**SKY (Escluso Sky Round 435)**

88  
**ELEMENT TAGLIERE  
 SLIDING 50 CM**  
 ATH010QU  
 Euro **153**  
 Pag. **142**



156  
**ELEMENT DRAINER  
 FLEX 500**  
 ARS023BK  
 Euro **92**  
 Pag. **144**



LAVELLI INOX



Compass 700 | Miscelatore Flux Cromato | Element Drainer flex 500 | Piano induzione Urban 80

COLLEZIONE  
**ACCESSORI**



## THE IDEAL PARTNER FOR EVERY MOMENT

Accessori Elleci: i perfetti alleati in cucina; ottimizzano lo spazio nell'area preparazione con soluzioni tecniche e funzionali che possono caratterizzare e rendere unico lo stile della cucina.

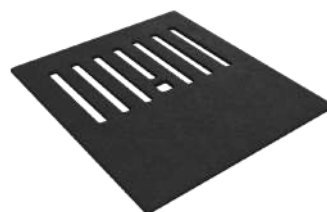

### TAGLIERE ELEMENT BEST WORKSTATION

Uno speciale tagliere che grazie al suo design diviene sistema multifunzione salvaspazio in quanto utilizzabile sia a bordo lavello che all'interno della vasca.

- BLACK
- GREY
- WOOD
- QUERCIA
- OLMO



### COLANDER ELEMENT BEST WORKSTATION

L'accessorio ideale per organizzare e scolare.



- BLACK
- CR CROMATO

**ELEMENT DISPENSER  
SAPONE TONDO**

Un utile accessorio integrato che crea spazio aggiuntivo nel lavello.



**DRAINER FLEX 500**

Dall'utilizzo versatile è comodissimo sia come scolapiatti (posizionato sopra il lavello) che come tappetino appoggiato sul top cucina.



- BLACK
- INOX
- GOLD

**KIT ELEMENT  
OPEN UP FLOW PRO**

Il suo stile semplice ma elegante e la semplicità di utilizzo lo rendono un kit moderno e adeguato per ogni stile.

## 193 ELEMENT TAGLIERE SPAZIO

Tagliere multifunzione in HPL

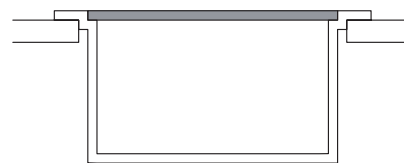
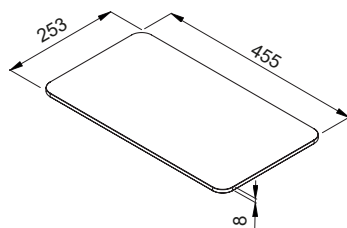

### COLORI DISPONIBILI

- Black**  
ATH123BK      Euro **112**
- Wood**  
ATH123WD      Euro **112**

### COMPATIBILITÀ COLLEZIONE

SPAZIO



## 88 ELEMENT TAGLIERE SLIDING 50

Tagliere multifunzione in HPL

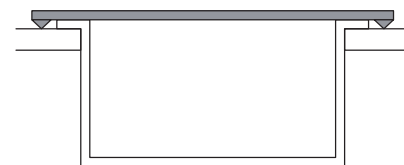
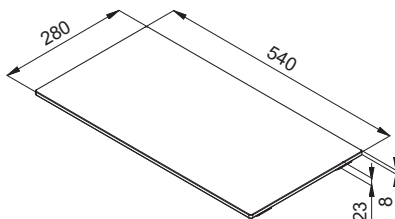

### COLORI DISPONIBILI

- Black**  
ATH010BK      Euro **153**
- Grey**  
ATH010GR      Euro **153**
- Quercia**  
ATH010QU      Euro **153**
- Olmo**  
ATH010OL      Euro **153**

### COMPATIBILITÀ COLLEZIONE

UNICO  
MASTER  
KARISMA  
FOX  
EGO  
EASY  
SKY



## 89 ELEMENT TAGLIERE BEST LINE

Tagliere multifunzione in HPL

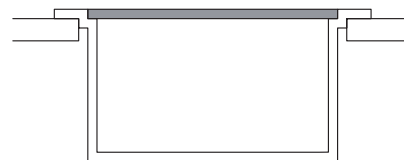
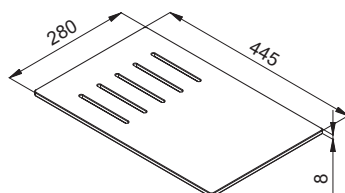

### COLORI DISPONIBILI

- Black**  
ATH020BK      Euro **128**
- Grey**  
ATH020GR      Euro **128**
- Quercia**  
ATH020QU      Euro **128**
- Olmo**  
ATH020OL      Euro **128**

### COMPATIBILITÀ COLLEZIONE

BEST





91 **ELEMENT TAGLIERE 420**

Tagliere multifunzione in HPL

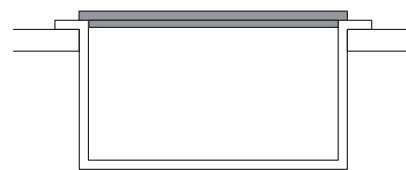
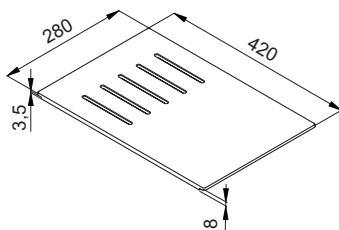

**COLORI DISPONIBILI**

● <b>Black</b>	ATH040BK	Euro <b>128</b>
● <b>Grey</b>	ATH040GR	Euro <b>128</b>
● <b>Quercia</b>	ATH040QU	Euro <b>128</b>
● <b>Olmo</b>	ATH040OL	Euro <b>128</b>
● <b>Wood</b>	ATH040WD	Euro <b>128</b>

**COMPATIBILITÀ COLLEZIONE**

ZEN  
QUADRA  
INTEGRA  
W-SQUARE  
COMPASS  
ESPRIT  
ZEN-F



155 **ELEMENT TAGLIERE FOX 360**

Tagliere multifunzione in HPL con vaschetta

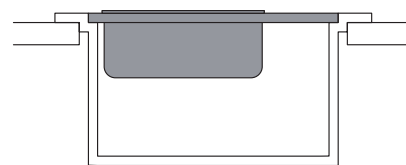
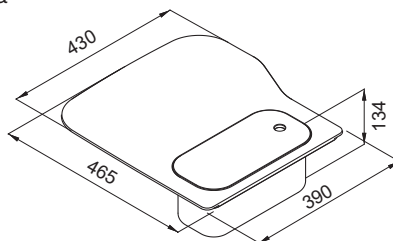

**COLORI DISPONIBILI**

● <b>Quercia</b>	ATH130QU	Euro <b>187</b>
● <b>Olmo</b>	ATH130OL	Euro <b>187</b>

**COMPATIBILITÀ COLLEZIONE**

FOX



93 **ELEMENT TAGLIERE BEST WORKSTATION**

Tagliere multifunzione in HPL

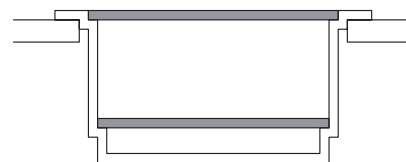
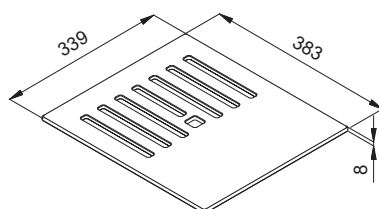

**COLORI DISPONIBILI**

● <b>Black</b>	ATH073BK	Euro <b>132</b>
● <b>Grey</b>	ATH073GR	Euro <b>132</b>
● <b>Quercia</b>	ATH073QU	Euro <b>132</b>
● <b>Olmo</b>	ATH073OL	Euro <b>132</b>
● <b>Wood</b>	ATH073WD	Euro <b>132</b>

**COMPATIBILITÀ COLLEZIONE**

BEST WORKSTATION



ACCESSORI

## 157 ELEMENT DRAINER FLEX 440

Drainer Flex in silicone

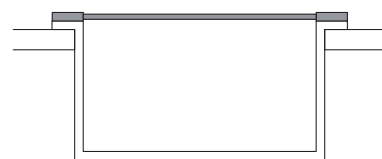
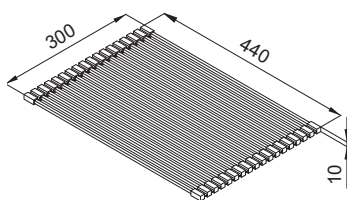

### COLORI DISPONIBILI

● **Black**  
ARS013BK Euro **83**

### COMPATIBILITÀ COLLEZIONE

GLOBE  
ZEN  
QUADRA  
QUADRA SOTTOTOP  
KARISMA  
INTEGRA  
EASY  
W-SQUARE  
COMPASS  
ESPRIT  
ZEN-F



## 156 ELEMENT DRAINER FLEX 500

Drainer Flex in silicone

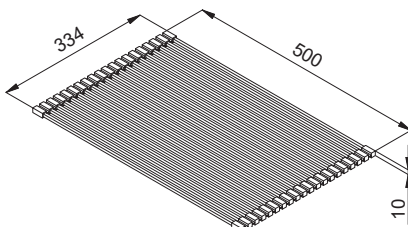

### COLORI DISPONIBILI

● **Black**  
ARS023BK Euro **92**

### COMPATIBILITÀ COLLEZIONE

UNICO  
QUADRA  
QUADRA SOTTOTOP  
MASTER  
FOX  
EGO  
EASY  
BEST  
BEST WORKSTATION  
SKY



## 153 ELEMENT COLANDER BEST WORKSTATION

Colander in Polipropilene

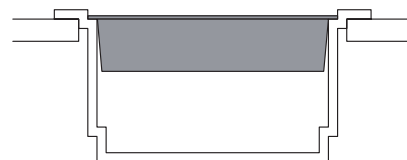
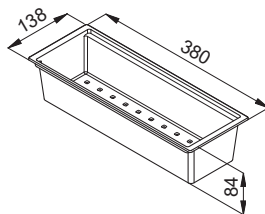

### COLORI DISPONIBILI

● **Black**  
AVP034BK Euro **67**

### COMPATIBILITÀ COLLEZIONE

BEST WORKSTATION



152 **ELEMENT COLANDER** 418

Colander in Polipropilene

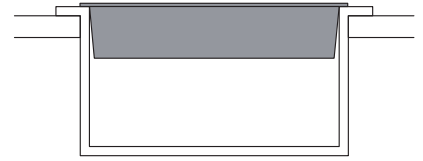
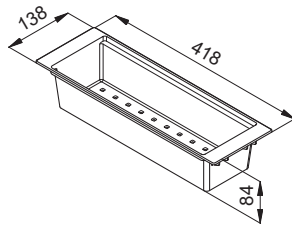

**COLORI DISPONIBILI**

● **Black**  
AVP035BK Euro **67**

**COMPATIBILITÀ COLLEZIONE**

ZEN  
QUADRA  
QUADRA SOTTOTOP  
INTEGRA  
SKY  
W-SQUARE  
COMPASS  
ESPRIT  
ZEN-F



25 **ELEMENT DISPENSER SAPONE TONDO**

Dispenser sapone

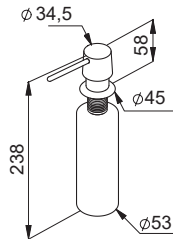

**COLORI DISPONIBILI**

● **Cromato**  
ADI02300 Euro **44**  
● **Black**  
ADI02300BK Euro **67**

**COMPATIBILITÀ COLLEZIONE**

UNICO  
QUADRA  
QUADRA SOTTOTOP  
FOX  
EASY  
BEST WORKSTATION



50 **ELEMENT DISPENSER SAPONE QUADRATO**

Dispenser sapone

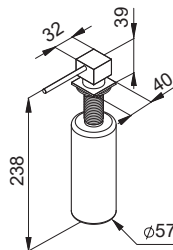

**COLORI DISPONIBILI**

● **Cromato**  
ADI02301 Euro **106**

**COMPATIBILITÀ COLLEZIONE**

UNICO  
QUADRA  
QUADRA SOTTOTOP  
KARISMA  
EASY  
BEST WORKSTATION



## 163 ELEMENT COVER PILETTA MATERICA

Cover piletta materica

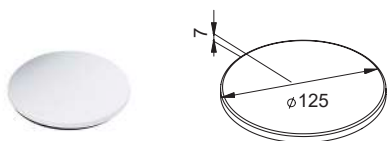





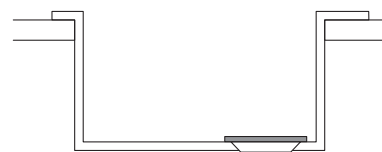





### COMPATIBILITÀ COLLEZIONE

ZEN  
UNICO  
QUADRA  
QUADRA SOTTOTOP  
MASTER  
INTEGRA  
FOX  
EGO  
EASY  
BEST  
BEST WORKSTATION



### COLORI DISPONIBILI

 <b>Black</b> AKCP1286 Euro <b>44</b>	 <b>Dark Grey</b> AKCP1299 Euro <b>44</b>
 <b>Dove Grey</b> AKCP1293 Euro <b>44</b>	 <b>Nero</b> AGCP1240 Euro <b>44</b>
 <b>Champagne</b> AKCP1295 Euro <b>44</b>	 <b>Tortora</b> AGCP1243 Euro <b>44</b>
 <b>White</b> AKCP1296 Euro <b>44</b>	 <b>Cemento</b> AGCP1248 Euro <b>44</b>
 <b>Light Grey</b> AKCP1297 Euro <b>44</b>	 <b>Bianco</b> AGCP1268 Euro <b>44</b>



## 88 KIT PILETTA E TROPPOPIENO

Kit Piletta e Troppopieno

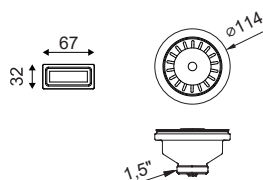

### COLORI DISPONIBILI

 <b>Black</b> COMPP90CTPLUXABK Euro <b>77</b>
---

### COMPATIBILITÀ COLLEZIONE

ZEN  
INTEGRA  
BEST  
BEST WORKSTATION



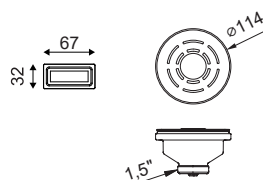

## 164 ELEMENT KIT FLOW PRO E TROPPO PIENO

Kit Piletta Flow Pro e Troppopieno



### COLORI DISPONIBILI

 <b>Black Matt</b> KITWPT-F-1VSELL-BK Euro <b>115</b>
 <b>Gold</b> KITWPT-F-1VSELL-GD Euro <b>95</b>

### COMPATIBILITÀ COLLEZIONE

SPAZIO  
BEST WORKSTATION  
ZEN  
ZEN F  
INTEGRA  
BEST



100 **ELEMENT OPEN-UP** PUSH CONTROL

Sistema di scarico 1 via via Flow Pro con comando remoto Open Up

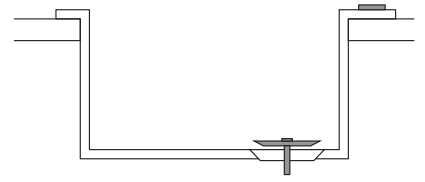
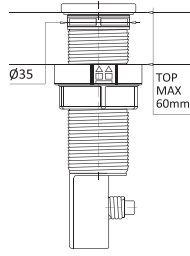

**COLORI DISPONIBILI**

- Inox**  
ASP13004                      Euro **66**
- Gold**  
ASP13004GD                  Euro **146**
- Black**  
ASP13004BK                  Euro **146**

**COMPATIBILITÀ COLLEZIONE**

- SPAZIO
- BEST WORKSTATION
- ZEN
- ZEN F
- INTEGRA
- BEST



97 **ELEMENT POP-UP** PUSH CONTROL

Kit piletta automatica a 1 via

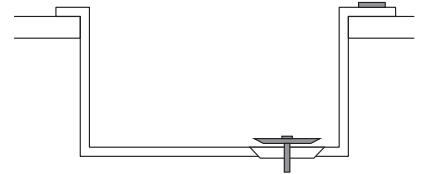
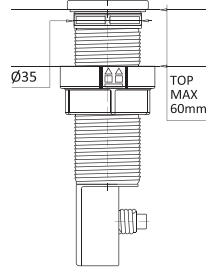

**COLORI DISPONIBILI**

- Cromato**  
ASP13002                      Euro **38**
- Black**  
ASP13002BK                  Euro **100**

**COMPATIBILITÀ COLLEZIONE**

- UNICO
- QUADRA
- MASTER
- FOX
- EGO
- EASY
- BEST
- BEST WORKSTATION



96 **ELEMENT POP-UP** PUSH CONTROL 2 VIE

Kit piletta automatica a 2 vie

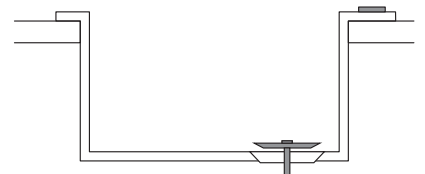
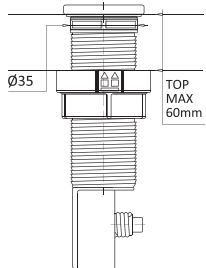

**COLORI DISPONIBILI**

- Cromato**  
ASP23002                      Euro **74**
- Black**  
ASP23002BK                  Euro **135**

**COMPATIBILITÀ COLLEZIONE**

- UNICO
- QUADRA
- QUADRA SOTTOTOP
- MASTER
- FOX
- EGO
- EASY
- BEST



## 97 ELEMENT POP-UP PUSH CONTROL

Kit piletta quadrata automatica a 1 via

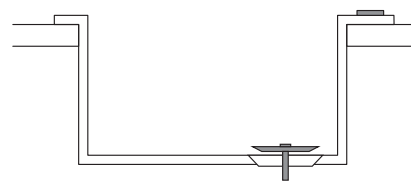
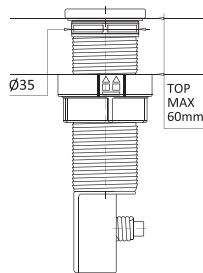

### COLORI DISPONIBILI

● Cromato  
ASP16302

Euro 62

### COMPATIBILITÀ COLLEZIONE

KARISMA





ACCESSORI

## TAGLIERI

### 4 TAGLIERE SCORREVOLE IN LEGNO



CARATTERISTICHE  
Dimensione (mm) 540 x 300  
Codice ATL01000  
Euro 104

### 10 TAGLIERE IN LEGNO EGO ROUND



CARATTERISTICHE  
Dimensione (mm) Ø435  
Codice ATL02300  
Euro 98

### 16 TAGLIERE IN LEGNO FOX ROUND / SKY ROUND 435



CARATTERISTICHE  
Dimensione (mm) Ø395  
Codice ATL02301  
Euro 98

### 46 TAGLIERE SKY 360



CARATTERISTICHE  
Dimensione (mm) 375 x 435  
Codice ATL01303  
Euro 90

## COLANDER

### 5 COLANDER



CARATTERISTICHE  
Dimensione (mm) 322 x 195 x 95  
Codice AVI03001  
Euro 131

### 63 COLANDER EASY CORNER



CARATTERISTICHE  
Dimensione (mm) 400 x 284 x 8  
Codice AVI03307  
Euro 121

### 61 COLANDER STD L



CARATTERISTICHE  
Dimensione (mm) 462 x 134 x 72  
Codice AVI03305  
Euro 131

### 70 COLANDER BEST LINE



CARATTERISTICHE  
Dimensione (mm) 444 x 142 x 103  
Codice AVI03000  
Euro 114

## BOTTOM GRID

### 43 BOTTOM GRID



CARATTERISTICHE  
Dimensione (mm) 277 x 348  
Codice AGB01300  
Euro 78

### 67 BOTTOM GRID M

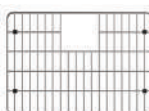

CARATTERISTICHE  
Dimensione (mm) 445 x 310  
Codice AGB01304  
Euro 110

### 68 BOTTOM GRID L



CARATTERISTICHE  
Dimensione (mm) 590 x 334  
Codice AGB01303  
Euro 110

### 71 BOTTOM GRID S



CARATTERISTICHE  
Dimensione (mm) 285 x 300  
Codice AGB01306  
Euro 120



## CESTELLI

### 8 CESTELLO EGO ROUND



CARATTERISTICHE

Dimensione (mm) Ø 345  
Codice ACI02300  
Euro 54

### 11 CESTELLO FOX 360



CARATTERISTICHE

Dimensione (mm) 405 x 312 x 195  
Codice ACI03300  
Euro 108

### 15 CESTELLO FOX ROUND / EASY ROUND / SKY ROUND 435



CARATTERISTICHE

Dimensione (mm) Ø 320  
Codice ACI02301  
Euro 74

### 69 CESTELLO BEST LINE



CARATTERISTICHE

Dimensione (mm) 444 x 292 x 82  
Codice ACI01306  
Euro 93

### 30 CESTELLO SKY



CARATTERISTICHE

Dimensione (mm) 348 x 324 x 112  
Codice ACI01304  
Euro 96

### 75 CESTELLO



CARATTERISTICHE

Dimensione (mm) 385 x 270 x 180  
Codice ACI01307  
Euro 105

### 49 CESTELLO SKY 360



CARATTERISTICHE

Dimensione (mm) 375 x 250 x 190  
Codice ACI01305  
Euro 130

## ALTRI ACCESSORI

### 9 SCOLAPIATTI



CARATTERISTICHE

Dimensione (mm) 300 x 185 x 82  
Codice ADI01300  
Euro 50

### 48 VASCHETTA IN POLICARBONATO SKY 360



CARATTERISTICHE

Dimensione (mm) 270 x 137 x 60  
Codice AVP01302  
Euro 23

### 47 VASCHETTA SKY 360



CARATTERISTICHE

Dimensione (mm) 274 x 148 x 63  
Codice AVI03002  
Euro 62

# COLLEZIONE MISCELATORI

Pensati per caratterizzare gli ambienti e per soddisfare le esigenze di ogni tipo di cucina, uniscono estetica e funzionalità. Una linea di miscelatori di design in diverse finiture e stili; moderni, utili ed al tempo stesso rispettosi dell'ambiente.



#### FULL COLOR

Miscelatori verniciati in ogni parte e componente del colore del lavello per un abbinamento perfetto ed una sensazione di continuità totale.

#### METAL FINISHINGS

Finiture eleganti e raffinate. Una Family line studiata per il perfect match con le componenti del lavello e con il mondo della cottura Elleci.



#### BLACK MATT

Una speciale finitura che incarna uno dei principali trend del design e si adatta anche alla perfezione a quasi qualsiasi stile offrendo infinite possibilità di personalizzazione.

#### ENERGY SAVE CARTRIDGE

Tecnologia che consente di erogare solo acqua fredda con la leva in posizione centrale, risparmiando energia e rispettando l'ambiente.

**PROFESSIONAL**



**NEW** **ARCADIA** \*  
PAG. 154

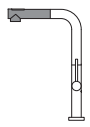

**FLUX** \*  
PAG. 155

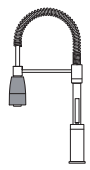

**CHEF** \*  
PAG. 156

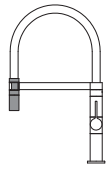

**WAVE** \*  
PAG. 154

**CANNA L**



**NEW** **KENT**  
PAG. 155



**TEMA**  
PAG. 156



**ARES**  
PAG. 157



**STREAM PLUS** \*  
PAG. 158



**DANUBIO**  
PAG. 165

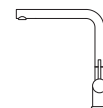

**STREAM**  
PAG. 158



**TRAIL PLUS** \*  
PAG. 159

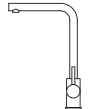

**TRAIL**  
PAG. 159

**FILTRANTE**

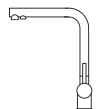

**TOURMALINE**  
PAG. 160

**CANNA A PONTE**

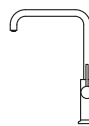

**NEW** **HYPE**  
PAG. 162

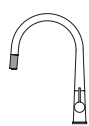

**NEW** **ATHENA PLUS** \*  
PAG. 161



**DORA PLUS** \*  
PAG. 162

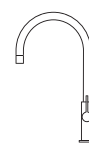

**VOLTA**  
PAG. 164

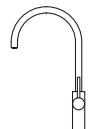

**NEW** **CLUB**  
PAG. 163



**NEVA** \*  
PAG. 165

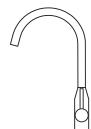

**ADIGE**  
PAG. 162



**ATHENA**  
PAG. 161



**BRIDGE**  
PAG. 163

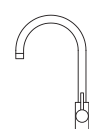

**CLOUD**  
PAG. 164

**TRADITIONAL**

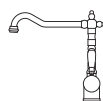

**RIO**  
PAG. 169

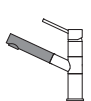

**RENO** \*  
PAG. 166

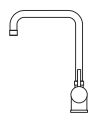

**SENNA**  
PAG. 167



**SAVA**  
PAG. 166

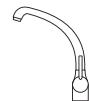

**PO**  
PAG. 167



**VENERE** \*  
PAG. 168



**MINERVA**  
PAG. 168

**FUNZIONI**  
MISCELATORI



CANNA GIREVOLE

\*



DOCCETTA



CAMBIO GETTO



FILTRANTE



SOTTO FINESTRA



FULL COLOR



SAVE ENERGY CARTRIDGE

# MISCELATORI ARCADIA **NEW**



Miscelatore monocomando con canna alta girevole e doccetta estraibile doppio getto

## CARATTERISTICHE

Base (mm) **47**  
 Rotazione canna **360°**  
 Tipologia flessibile **Inox 3/8"**  
 Lunghezza flessibile **390 mm**  
 Cartuccia (ø mm) **25**  
 Foro top (mm) **35**

## FINITURE Euro 390

 **Cromato** MIKARCCR  
 CR

## COLORE \* Euro 480

 **Black** MOKARCBK  
 BK

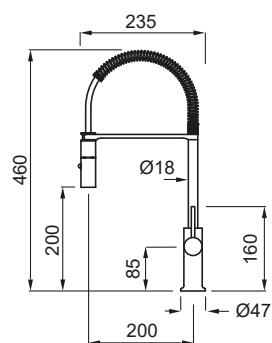

CR Cromato

# WAVE



Miscelatore monocomando con canna alta girevole in silicone e doccetta estraibile

## CARATTERISTICHE

Base (mm) **50**  
 Rotazione canna **360°**  
 Tipologia flessibile **Inox 3/8"**  
 Lunghezza flessibile **400 mm**  
 Cartuccia (ø mm) **25**  
 Foro top (mm) **35**

## FINITURE Euro 315

 **Cromato** MIKWAVCR  
 CR

## COLORE \* Euro 357

 **Black** MOKWAVBK  
 BK

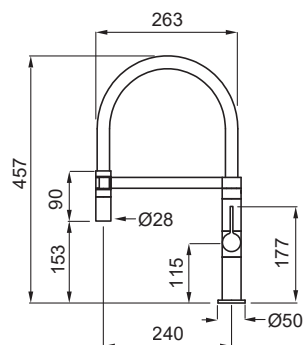

CR Cromato

\* Colori abbinabili ai materiali Keratek e Granitek

**KENT** NEW



Gold  
GD

Miscelatore monocomando con canna girevole e comando remoto

**CARATTERISTICHE**

Base (mm) **46 (canna) - 52 (comando)**  
 Rotazione canna **360°**  
 Tipologia flessibile **Inox 3/8"**  
 Lunghezza flessibile **490 mm**  
 Cartuccia (ø mm) **25**  
 Foro top (mm) **35 (canna) - 35 (comando)**

**FINITURE** Euro **520**

 **Cr. Spazzolato** MIKKENCS  
CS

Euro **650**

 **Gold** MOKKENG  
GD

**COLORE \*** Euro **460**

 **Black** MOKKEN  
BK

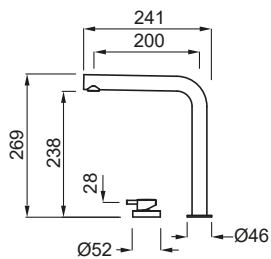

CS Cr. Spazzolato

**FLUX**



Black  
BK

Miscelatore monocomando con canna girevole e doccetta estraibile doppio getto

**CARATTERISTICHE**

Base (mm) **50**  
 Rotazione canna **360°**  
 Tipologia flessibile **Inox 3/8"**  
 Lunghezza flessibile **550 mm**  
 Cartuccia (ø mm) **25**  
 Foro top (mm) **35**

**FINITURE** Euro **428**

 **Cromato** MIKFLUCR  
CR

**COLORE \*** Euro **473**

 **Black** MOKFLUBK  
BK

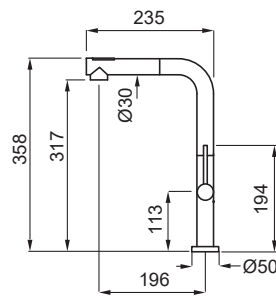

CR Cromato

\* Colori abbinabili ai materiali Keratek e Granitek

MISCELATORI

# MISCELATORI CHEF



Miscelatore monocomando con canna alta girevole e doccetta doppio getto

## CARATTERISTICHE

Base (mm) **50**  
 Rotazione canna **360°**  
 Tipologia flessibile **Inox 3/8"**  
 Lunghezza flessibile **350 mm**  
 Cartuccia (ø mm) **35**  
 Foro top (mm) **35**

## FINITURE Euro 360

 **Cromato CR** MIKCHECR

## COLORE \* Euro 398

 **Black K86** MKKCHE86  
 **Nero G40** MGKCHE40

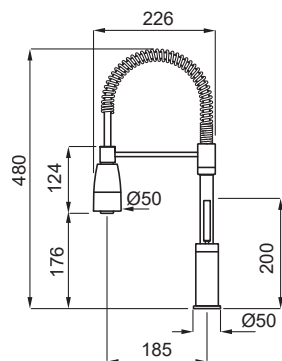

CR Cromato

# TEMA



Miscelatore monocomando con canna girevole







## CARATTERISTICHE

Base (mm) **50**  
 Rotazione canna **360°**  
 Tipologia flessibile **Inox 3/8"**  
 Lunghezza flessibile **700 mm**  
 Cartuccia (ø mm) **25**  
 Foro top (mm) **35**

## FINITURE Euro 518

 **Cromato CR** MIKTEMCR

## COLORE \* Euro 574

 **Black K86** MKKTEM86  
 **Dove Grey K93** MKKTEM93  
 **Champagne K95** MKKTEM95  
 **White K96** MKKTEM96  
 **Light Grey K97** MKKTEM97  
 **Dark Grey K99** MKKTEM99

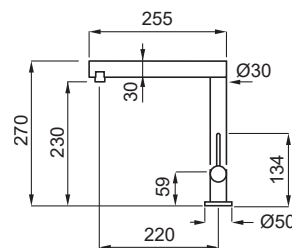

CR Cromato

\* Colori abbinabili ai materiali Keratek e Granitek

**HYPE** NEW





Miscelatore monocomando con canna girevole

**CARATTERISTICHE**

Base (mm) **47**  
 Rotazione canna **360°**  
 Tipologia flessibile **Inox 3/8"**  
 Lunghezza flessibile **390 mm**  
 Cartuccia (ø mm) **25**  
 Foro top (mm) **35**

**FINITURE** Euro **398**

 **Cr. Spazzolato** MIKHYP  
 CS  
 **Gold** MOKHYPGD  
 GD

**COLORE \*** Euro **318**

 **Black** MOKHYPBK  
 BK

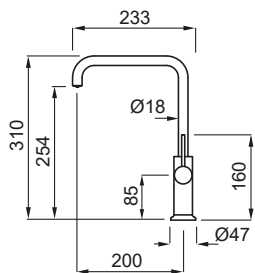

CS Cr. Spazzolato

**ARES**



Miscelatore monocomando con canna girevole









**CARATTERISTICHE**

Base (mm) **45**  
 Rotazione canna **360°**  
 Tipologia flessibile **Inox 3/8"**  
 Lunghezza flessibile **350 mm**  
 Cartuccia (ø mm) **25**  
 Foro top (mm) **35**

**FINITURE** Euro **345**

 **Cromato** MIKARECR  
 CR

**COLORE \*** Euro **430**

 **Black** MKKARE86  
 K86  
 **White** MKKARE96  
 K96  
 **Titanium** MMKARE73  
 M73  
 **Aluminium** MMKARE79  
 M79  
 **Nero** MGKARE40  
 G40  
 **Tortora** MGKARE43  
 G43  
 **Cemento** MGKARE48  
 G48  
 **Bianco** MGKARE68  
 G68

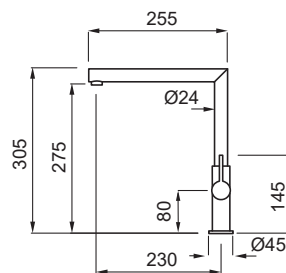

CR Cromato

\* Colori abbinabili ai materiali Keratek e Granitek

# MISCELATORI STREAM



**Tortora**  
G43

Miscelatore monocomando con canna girevole

## CARATTERISTICHE

Base (mm) **50**  
 Rotazione canna **360°**  
 Tipologia flessibile **Inox 3/8"**  
 Lunghezza flessibile **350 mm**  
 Cartuccia (ø mm) **35**  
 Foro top (mm) **35**











## FINITURE

 Euro 315

 **Cromato** **CR** MIKSTRCR

## COLORE \*

 Euro 360

-  **Black** **K86** MKKSTR86
-  **White** **K96** MKKSTR96
-  **Dark Grey** **K99** MKKSTR99
-  **Titanium** **M73** MMKSTR73
-  **Aluminium** **M79** MMKSTR79
-  **Nero** **G40** MGKSTR40
-  **Tortora** **G43** MGKSTR43
-  **Cemento** **G48** MGKSTR48
-  **Bianco** **G68** MGKSTR68
-  **Espresso** **G78** MGKSTR78
-  **Avena** **G51** MGKSTR51

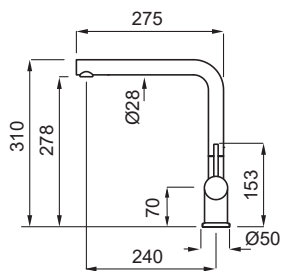

**CR Cromato**

# STREAM PLUS



**Black**  
K86

Miscelatore monocomando con canna girevole e doccetta estraibile

## CARATTERISTICHE

Base (mm) **50**  
 Rotazione canna **360°**  
 Tipologia flessibile **Inox 3/8"**  
 Lunghezza flessibile **350 mm**  
 Cartuccia (ø mm) **35**  
 Foro top (mm) **35**















## FINITURE

 Euro 364

 **Cromato** **CR** MIKSTPCR

## COLORE \*

 Euro 413

-  **Black** **K86** MKKSTP86
-  **Dove Grey** **K93** MKKSTP93
-  **Champagne** **K95** MKKSTP95
-  **White** **K96** MKKSTP96
-  **Light Grey** **K97** MKKSTP97
-  **Dark Grey** **K99** MKKSTP99
-  **Titanium** **M73** MMKSTP73
-  **Aluminium** **M79** MMKSTP79
-  **Nero** **G40** MGKSTP40
-  **Tortora** **G43** MGKSTP43
-  **Cemento** **G48** MGKSTP48
-  **Bianco** **G68** MGKSTP68
-  **Espresso** **G78** MGKSTP78
-  **Avena** **G51** MGKSTP51

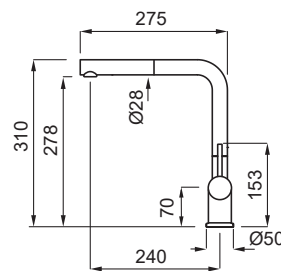

**CR Cromato**

\* Colori abbinabili ai materiali Keratek e Granitek



# TRAIL



Nero  
G40

Miscelatore monocomando con canna girevole

### CARATTERISTICHE

Base (mm) **50**  
 Rotazione canna **360°**  
 Tipologia flessibile **Inox 3/8"**  
 Lunghezza flessibile **350 mm**  
 Cartuccia (ø mm) **35**  
 Foro top (mm) **35**

### FINITURE

**Cromato CR** MIKTRACR **Euro 216**

### COLORE \*

- |  |                          |          |
|--|--------------------------|----------|
|  | <b>Black K86</b>         | MKKTRA86 |
|  | <b>Dove Grey K93</b>     | MKKTRA93 |
|  | <b>Champagne K95</b>     | MKKTRA95 |
|  | <b>White K96</b>         | MKKTRA96 |
|  | <b>Light Grey K97</b>    | MKKTRA97 |
|  | <b>Dark Grey K99</b>     | MKKTRA99 |
|  | <b>Titanium M73</b>      | MMKTRA73 |
|  | <b>Aluminium M79</b>     | MMKTRA79 |
|  | <b>Nero G40</b>          | MGKTRA40 |
|  | <b>Tortora G43</b>       | MGKTRA43 |
|  | <b>Cemento G48</b>       | MGKTRA48 |
|  | <b>Bianco G68</b>        | MGKTRA68 |
|  | <b>Espresso G78</b>      | MGKTRA78 |
|  | <b>Avena G51</b>         | MGKTRA51 |
|  | <b>Antracite G59</b>     | MGKTRA59 |
|  | <b>Bianco Antico G62</b> | MGKTRA62 |

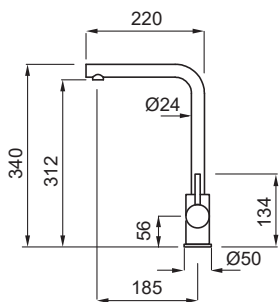

CR Cromato

# TRAIL PLUS



Bianco  
G68

Miscelatore monocomando con canna girevole e doccetta estraibile

### CARATTERISTICHE

Base (mm) **50**  
 Rotazione canna **360°**  
 Tipologia flessibile **Inox 3/8"**  
 Lunghezza flessibile **400 mm**  
 Cartuccia (ø mm) **35**  
 Foro top (mm) **35**

### FINITURE

**Cromato CR** MIKTRPCR **Euro 292**

### COLORE \*

- |  |                          |          |
|--|--------------------------|----------|
|  | <b>Black K86</b>         | MKKTRP86 |
|  | <b>White K96</b>         | MKKTRP96 |
|  | <b>Titanium M73</b>      | MMKTRP73 |
|  | <b>Aluminium M79</b>     | MMKTRP79 |
|  | <b>Nero G40</b>          | MGKTRP40 |
|  | <b>Tortora G43</b>       | MGKTRP43 |
|  | <b>Cemento G48</b>       | MGKTRP48 |
|  | <b>Bianco G68</b>        | MGKTRP68 |
|  | <b>Espresso G78</b>      | MGKTRP78 |
|  | <b>Avena G51</b>         | MGKTRP51 |
|  | <b>Antracite G59</b>     | MGKTRP59 |
|  | <b>Bianco Antico G62</b> | MGKTRP62 |

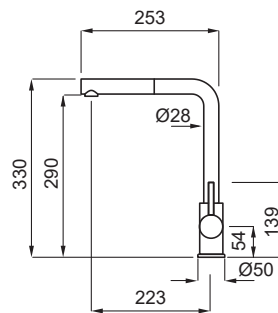

CR Cromato

\* Colori abbinabili ai materiali Keratek e Granitek

MISCELATORI

# MISCELATORI TOURMALINE



Miscelatore filtrante monocomando con canna girevole

## CARATTERISTICHE

Base (mm)	<b>50</b>
Rotazione canna	<b>360°</b>
Tipologia flessibile	<b>Inox 3/8"</b>
Lunghezza flessibile	<b>400 mm</b>
Cartuccia (ø mm)	<b>35</b>
Foro top (mm)	<b>35</b>





## FINITURE

Euro **311**

 <b>Inox</b>	MIKTOUIN
<b>IN</b>	

## COLORE \*

Euro **311**

 <b>Black</b>	MKKTOU86
<b>K86</b>	
 <b>White</b>	MKKTOU96
<b>K96</b>	
 <b>Nero</b>	MGKTOU40
<b>G40</b>	
 <b>Bianco</b>	MGKTOU68
<b>G68</b>	
 <b>Avena</b>	MGKTOU51
<b>G51</b>	

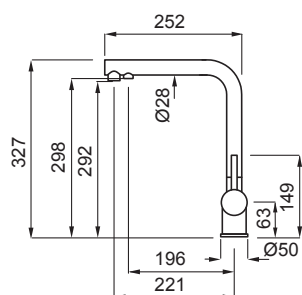

## SISTEMA DI FILTRAGGIO

Il sistema filtrante Elleci trasforma il rubinetto della tua cucina in una sorgente d'acqua fresca e depurata. Un miscelatore con sistema filtrante riduce il contenuto di metalli pesanti, cloro e calcare presenti nell'acqua del rubinetto ed è pratico da utilizzare poiché il filtro è collegato direttamente al rubinetto dell'impianto idrico di casa e fornisce in tal modo acqua filtrata ogni volta che serve.

La cartuccia di ricambio del filtro assicura una capacità filtrante di 4.000 litri (consigliata la sostituzione almeno a cadenza annuale):

- Durata fino a 4.000 litri / 6 mesi

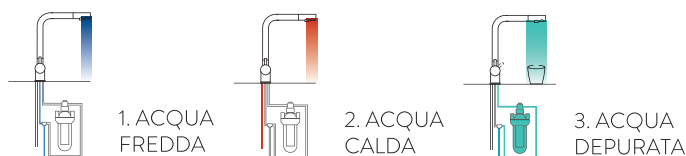

## ACCESSORI



Kit Filtraggio  
AF101300  
Euro **160**



Ricambio Filtro  
RFP01300  
Euro **83**

\* Colori abbinabili ai materiali Keratek e Granitek

# ATHENA

# ATHENA PLUS NEW



Miscelatore monocomando con canna girevole

Miscelatore monocomando con canna girevole e doccetta estraibile

### CARATTERISTICHE

Base (mm) **35**  
 Rotazione canna **360°**  
 Tipologia flessibile **Inox 3/8"**  
 Lunghezza flessibile **500 mm**  
 Cartuccia (ø mm) **25**  
 Foro top (mm) **48**

### FINITURE Euro 290

 **Cromato CR** MIKATHCR

### COLORE \* Euro 363

 **Titanium M73** MMKATH73  
 **Aluminium M79** MMKATH79  
 **Nero G40** MGKATH40  
 **Tortora G43** MGKATH43  
 **Cemento G48** MGKATH48  
 **Bianco G68** MGKATH68

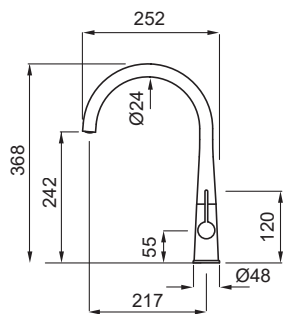







### CARATTERISTICHE

Base (mm) **35**  
 Rotazione canna **360°**  
 Tipologia flessibile **Inox 3/8"**  
 Lunghezza flessibile **500 mm**  
 Cartuccia (ø mm) **25**  
 Foro top (mm) **48**

### FINITURE Euro 320

 **Cromato CR** MIKATPCR

### COLORE \* Euro 390

 **Titanium M73** MMKATP73  
 **Aluminium M79** MMKATP79  
 **Nero G40** MGKATP40  
 **Tortora G43** MGKATP43  
 **Cemento G48** MGKATP48  
 **Bianco G68** MGKATP68

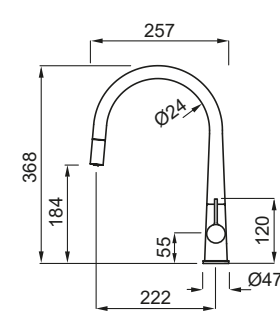

CR Cromato



CR Cromato

\* Colori abbinabili ai materiali Keratek e Granitek

MISCELATORI

# MISCELATORI ADIGE



Miscelatore monocomando con canna girevole

## CARATTERISTICHE

Base (mm)	<b>50</b>
Rotazione canna	<b>360°</b>
Tipologia flessibile	<b>Inox 3/8"</b>
Lunghezza flessibile	<b>400 mm</b>
Cartuccia (ø mm)	<b>35</b>
Foro top (mm)	<b>35</b>

## FINITURE

Euro **317**

	<b>Inox</b>	MIKADIIN
---	-------------	----------

## COLORE \*

Euro **317**

	<b>Black</b>	MKKADI86
	<b>White</b>	MKKADI96
	<b>Nero</b>	MGKADI40
	<b>Bianco</b>	MGKADI68

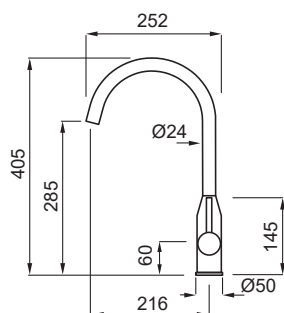

# DORA PLUS



Miscelatore monocomando con canna girevole e doccetta estraibile

## CARATTERISTICHE

Base (mm)	<b>50</b>
Rotazione canna	<b>360°</b>
Tipologia flessibile	<b>Inox 3/8"</b>
Lunghezza flessibile	<b>400 mm</b>
Cartuccia (ø mm)	<b>35</b>
Foro top (mm)	<b>35</b>

## FINITURE

Euro **386**

	<b>Inox</b>	MIKDRPIN
---	-------------	----------

## COLORE \*

Euro **386**

	<b>Black</b>	MKKDRP86
	<b>White</b>	MKKDRP96
	<b>Nero</b>	MGKDRP40
	<b>Bianco</b>	MGKDRP68

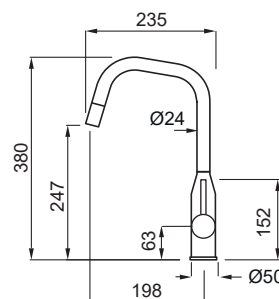

\* Colori abbinabili ai materiali Keratek e Granitek

**CLUB** NEW





Miscelatore monocomando con canna girevole

**CARATTERISTICHE**

Base (mm) **47**  
 Rotazione canna **360°**  
 Tipologia flessibile **Inox 3/8"**  
 Lunghezza flessibile **390 mm**  
 Cartuccia (ø mm) **25**  
 Foro top (mm) **35**

**FINITURE** Euro **398**

 **Cr. Spazzolato** MIKCLUCS  
 CS  
 **Gold** MOKCLUGD  
 GD

**COLORE \*** Euro **318**

 **Black** MOKCLUBK  
 BK

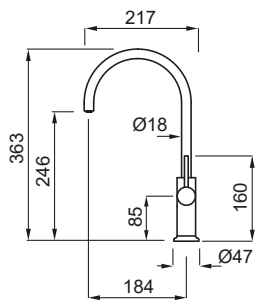

**CS Cr. Spazzolato**

**BRIDGE**



Miscelatore monocomando con canna girevole

**CARATTERISTICHE**

Base (mm) **50**  
 Rotazione canna **360°**  
 Tipologia flessibile **Inox 3/8"**  
 Lunghezza flessibile **350 mm**  
 Cartuccia (ø mm) **35**  
 Foro top (mm) **35**

**FINITURE** Euro **234**

 **Cromato** MIKBRICR  
 CR

**COLORE \*** Euro **281**

 **Black** MKKBRI86  
 K86  
 **White** MKKBRI96  
 K96  
 **Titanium** MMKBRI73  
 M73  
 **Aluminium** MMKBRI79  
 M79  
 **Nero** MGKBRI40  
 G40  
 **Tortora** MGKBRI43  
 G43  
 **Cemento** MGKBRI48  
 G48  
 **Bianco** MGKBRI68  
 G68  
 **Avena** MGKBRI51  
 G51

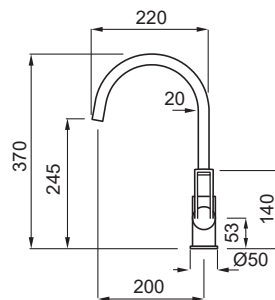

**CR Cromato**

\* Colori abbinabili ai materiali Keratek e Granitek

MISCELATORI

# MISCELATORI VOLTA



Miscelatore monocomando con canna girevole

## CARATTERISTICHE

Base (mm) **45**  
 Rotazione canna **360°**  
 Tipologia flessibile **Inox 3/8"**  
 Lunghezza flessibile **350 mm**  
 Cartuccia (ø mm) **35**  
 Foro top (mm) **35**

## FINITURE

**Euro 287**  
 Cromato CR MIKVTA CR

## COLORE \*

	<b>Black</b> K86	MKKVTA86
	<b>White</b> K96	MKKVTA96
	<b>Titanium</b> M73	MMKVTA73
	<b>Aluminium</b> M79	MMKVTA79
	<b>Nero</b> G40	MGKVTA40
	<b>Tortora</b> G43	MGKVTA43
	<b>Cemento</b> G48	MGKVTA48
	<b>Bianco</b> G68	MGKVTA68

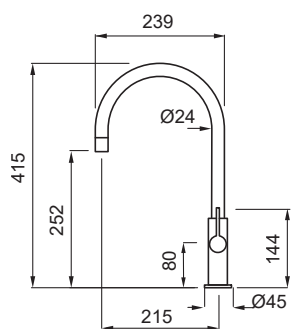

CR Cromato

# CLOUD



Miscelatore monocomando con canna girevole

## CARATTERISTICHE

Base (mm) **48**  
 Rotazione canna **360°**  
 Tipologia flessibile **Inox 3/8"**  
 Lunghezza flessibile **390 mm**  
 Cartuccia (ø mm) **35**  
 Foro top (mm) **35**

## FINITURE

**Euro 198**  
 Cromato CR MIKCLO CR

## COLORE \*

	<b>Black</b> K86	MKKCLO86
	<b>Dove Grey</b> K93	MKKCLO93
	<b>Champagne</b> K95	MKKCLO95
	<b>White</b> K96	MKKCLO96
	<b>Light Grey</b> K97	MKKCLO97
	<b>Dark Grey</b> K99	MKKCLO99
	<b>Titanium</b> M73	MMKCLO73
	<b>Aluminium</b> M79	MMKCLO79
	<b>Nero</b> G40	MGKCLO40
	<b>Tortora</b> G43	MGKCLO43
	<b>Cemento</b> G48	MGKCLO48
	<b>Bianco</b> G68	MGKCLO68
	<b>Espresso</b> G78	MGKCLO78
	<b>Avena</b> G51	MGKCLO51
	<b>Antracite</b> G59	MGKCLO59
	<b>Bianco Antico</b> G62	MGKCLO62

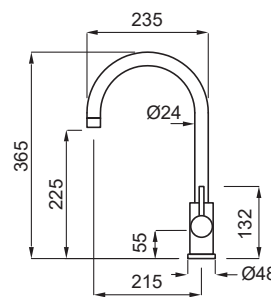

CR Cromato

\* Colori abbinabili ai materiali Keratek e Granitek

# NEVA



Miscelatore monocomando con canna girevole e doccetta estraibile

## CARATTERISTICHE

Base (mm) **50**  
 Rotazione canna **360°**  
 Tipologia flessibile **Inox 3/8"**  
 Lunghezza flessibile **400 mm**  
 Cartuccia (ø mm) **35**  
 Foro top (mm) **35**

## FINITURE

**Inox** IN MIKNEVIN Euro **318**

## COLORE \*

**Nero** G40 MGKNEV40 Euro **318**  
**Bianco** G68 MGKNEV68  
**Avena** G51 MGKNEV51  
**Antracite** G59 MGKNEV59  
**Bianco Antico** G62 MGKNEV62

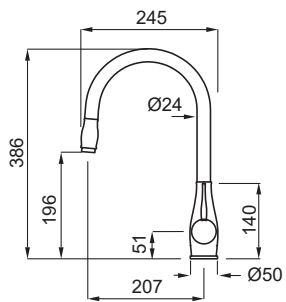

# DANUBIO



Miscelatore monocomando reclinabile con canna girevole

## CARATTERISTICHE

Base (mm) **50**  
 Rotazione canna **360°**  
 Tipologia flessibile **Inox 3/8"**  
 Lunghezza flessibile **350 mm**  
 Cartuccia (ø mm) **40**  
 Foro top (mm) **35**

## FINITURE

**Cromato** CR MIKDANCR Euro **370**

## COLORE \*

**Nero** G40 MGKDAN40 Euro **412**  
**Bianco** G68 MGKDAN68  
**Avena** G51 MGKDAN51

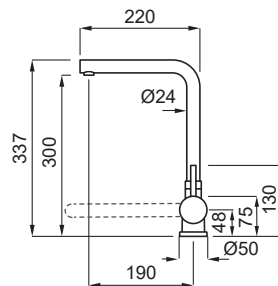

CR Cromato

\* Colori abbinabili ai materiali Keratek e Granitek

MISCELATORI

# MISCELATORI SAVA



**Cemento**  
G48

Miscelatore monocomando con canna girevole

## CARATTERISTICHE

Base (mm) **50**  
 Rotazione canna **360°**  
 Tipologia flessibile **Inox 3/8"**  
 Lunghezza flessibile **350 mm**  
 Cartuccia (ø mm) **35**  
 Foro top (mm) **35**

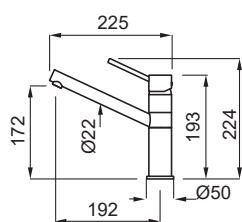

## FINITURE Euro 221

**Cromato** CR MIKSAVCR

## COLORE \* Euro 270

- Black** K86 MKKSAV86
- White** K96 MKKSAV96
- Titanium** M73 MMKSAV73
- Aluminium** M79 MMKSAV79
- Nero** G40 MGKSAV40
- Tortora** G43 MGKSAV43
- Cemento** G48 MGKSAV48
- Bianco** G68 MGKSAV68
- Espresso** G78 MGKSAV78
- Avena** G51 MGKSAV51
- Antracite** G59 MGKSAV59
- Bianco Antico** G62 MGKSAV62



**CR Cromato**

# RENO



**Tortora**  
G43

Miscelatore monocomando con canna girevole e doccetta estraibile

## CARATTERISTICHE

Base (mm) **50**  
 Rotazione canna **360°**  
 Tipologia flessibile **Inox 3/8"**  
 Lunghezza flessibile **350 mm**  
 Cartuccia (ø mm) **35**  
 Foro top (mm) **35**

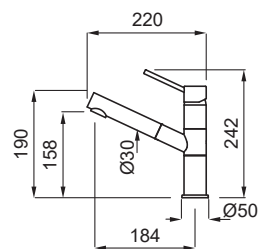

## FINITURE Euro 276

**Cromato** CR MIKRENCR

## COLORE \* Euro 328

- Black** K86 MKKREN86
- White** K96 MKKREN96
- Titanium** M73 MMKREN73
- Aluminium** M79 MMKREN79
- Nero** G40 MGKREN40
- Tortora** G43 MGKREN43
- Cemento** G48 MGKREN48
- Bianco** G68 MGKREN68
- Espresso** G78 MGKREN78
- Avena** G51 MGKREN51
- Antracite** G59 MGKREN59
- Bianco Antico** G62 MGKREN62



**CR Cromato**

\* Colori abbinabili ai materiali Keratek e Granitek



# SENNA



Miscelatore monocomando con canna girevole

## CARATTERISTICHE

Base (mm) **54**  
 Rotazione canna **360°**  
 Tipologia flessibile **Inox 3/8"**  
 Lunghezza flessibile **350 mm**  
 Cartuccia (ø mm) **35**  
 Foro top (mm) **35**

## FINITURE Euro 174

 **Cromato CR** MIKSENCR

## COLORE \* Euro 222

-  **Nero G40** MGKSEN40
-  **Bianco G68** MGKSEN68
-  **Avena G51** MGKSEN51
-  **Antracite G59** MGKSEN59
-  **Bianco Antico G62** MGKSEN62

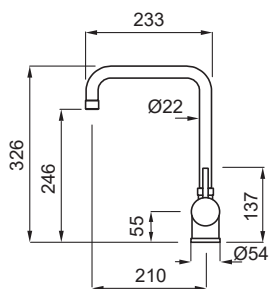

CR Cromato

# PO



Miscelatore monocomando con canna girevole

## CARATTERISTICHE

Base (mm) **51**  
 Rotazione canna **360°**  
 Tipologia flessibile **Inox 3/8"**  
 Lunghezza flessibile **330 mm**  
 Cartuccia (ø mm) **35**  
 Foro top (mm) **35**

## FINITURE Euro 190

 **Cromato CR** MIKPOCR

## COLORE \* Euro 213

-  **Titanium M73** MMKPO73
-  **Aluminium M79** MMKPO79
-  **Nero G40** MGKPO40
-  **Bianco G68** MGKPO68
-  **Avena G51** MGKPO51
-  **Antracite G59** MGKPO59
-  **Bianco Antico G62** MGKPO62

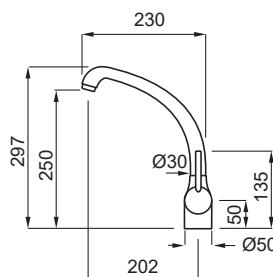

CR Cromato

\* Colori abbinabili ai materiali Keratek e Granitek

# MISCELATORI MINERVA



Miscelatore monocomando con canna girevole

## CARATTERISTICHE

Base (mm)	<b>50</b>
Rotazione canna	<b>360°</b>
Tipologia flessibile	<b>Inox 3/8"</b>
Lunghezza flessibile	<b>400 mm</b>
Cartuccia (ø mm)	<b>40</b>
Foro top (mm)	<b>35</b>

## FINITURE

Euro 105

	<b>Cromato</b> CR	MIKMINCR
---	----------------------	----------

## COLORE \*

Euro 146

	<b>Titanium</b> M73	MMKMIN73
	<b>Aluminium</b> M79	MMKMIN79
	<b>Nero</b> G40	MGKMIN40
	<b>Bianco</b> G68	MGKMIN68
	<b>Avena</b> G51	MGKMIN51
	<b>Antracite</b> G59	MGKMIN59
	<b>Bianco Antico</b> G62	MGKMIN62

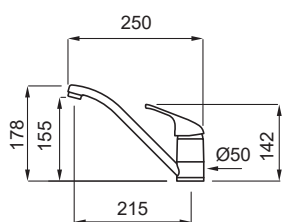

CR Cromato

# VENERE

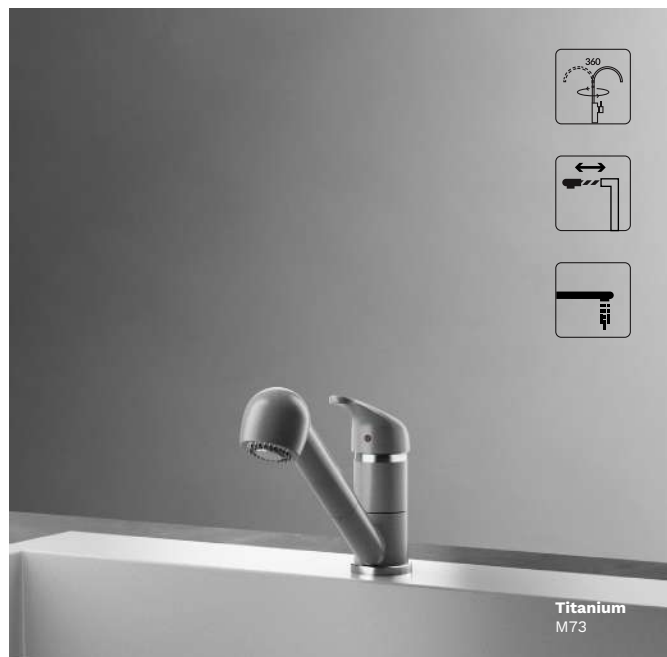

Miscelatore monocomando con canna girevole e doccetta estraibile doppio getto

## CARATTERISTICHE

Base (mm)	<b>55</b>
Rotazione canna	<b>360°</b>
Tipologia flessibile	<b>Inox 3/8"</b>
Lunghezza flessibile	<b>350 mm</b>
Cartuccia (ø mm)	<b>35</b>
Foro top (mm)	<b>35</b>







## FINITURE

Euro 152

	<b>Cromato</b> CR	MIKVENCR
---	----------------------	----------

## COLORE \*

Euro 190

	<b>Titanium</b> M73	MMKVEN73
	<b>Aluminium</b> M79	MMKVEN79
	<b>Bianco</b> G68	MGKVEN68
	<b>Avena</b> G51	MGKVEN51
	<b>Antracite</b> G59	MGKVEN59
	<b>Bianco Antico</b> G62	MGKVEN62

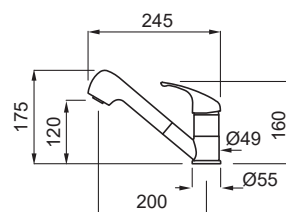

CR Cromato

\* Colori abbinabili ai materiali Keratek e Granitek

# RIO



Bianco Antico  
G62

Miscelatore monocomando con canna girevole

### CARATTERISTICHE

Base (mm) **54**  
 Rotazione canna **360°**  
 Tipologia flessibile **Inox 3/8"**  
 Lunghezza flessibile **350 mm**  
 Cartuccia (ø mm) **35**  
 Foro top (mm) **35**

### FINITURE

Euro **315**

 **Cromato** **CR** MIKRIOCR

Euro **336**

 **Rame** **RA** MIKRIORA

### COLORE \*

Euro **336**

 **Avena** **G51** MGKRIO51

 **Antracite** **G59** MGKRIO59

 **Bianco Antico** **G62** MGKRIO62

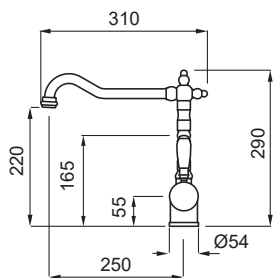

CR Cromato

\* Colori abbinabili ai materiali Keratek e Granitek



MISCELATORI

COLLEZIONE  
**ELDOM**  
URBAN



**URBAN  
GAS ON GLASS 75**

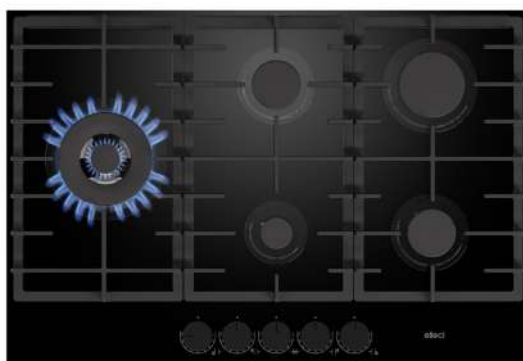

**TOTAL BLACK GLASS**

Una combinazione profonda e brillante allo stesso tempo. La famiglia di prodotti Urban è caratterizzata dall'unione del materiale vetro e il colore nero per un risultato elegante, lineare e pulito.



**FULL COLOR MATCHING**

Abbinamento totale.

Piano cottura, lavello, miscelatore e forno uniti da un unico colore.

Il lavello e il miscelatore sono verniciati in ogni loro parte del colore di riferimento, il forno si abbinerà attraverso la cornice laterale, mentre il piano cottura attraverso la base di appoggio.



**PLANO 75**



Piano cottura a induzione in vetroceramica da 80 cm

CARATTERISTICHE

4 zone cottura con funzione **Bridge**

- 2 \* - 210 mm
- 3.0 kW + Ø 250 mm
- 2.3 kW + Ø 145 mm
- 1.4 kW

Comando **Stop-Go** di sospensione e riavvio cottura.

Led bianchi.

Comandi slider.

Fino a 9 livelli di potenza.

Limitatore di potenza programmabile su 8 livelli (1.0 - 1.5 - 2.8 - 3.5 - 3.7 - 4.5 - 6.0 - 7.4 kW).

Potenza massima 7.4 kW.

Programmazione digitale del tempo di cottura indipendente per ciascuna zona.

Funzione timer con allarme acustico.

Spegnimento automatico.

Rilevazione presenza pentola.

FINITURE

**Black**  
K86

Euro 1.940

PVIU801BK

SICUREZZA

Indicatore calore residuo.

Blocco di sicurezza bambini.

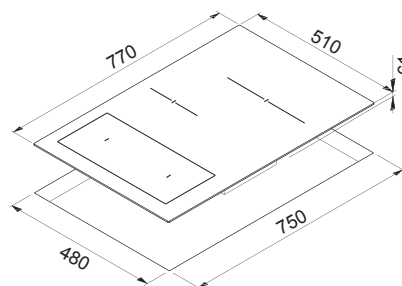

**PLUS**

**1 kW** LIMITATORE DI POTENZA

**+** BRIDGE ZONE

**↔** SLIDING TOUCH CONTROL

**>||** STOP GO

**LED** WHITE LED

PLUS



**URBAN 60** **NEW**

60



Piano cottura a induzione in vetroceramica da 60 cm

CARATTERISTICHE

4 zone cottura con funzione **Bridge**

- 2 \* - 210 mm
- 3.0 kW + Ø 200 mm
- 2.3 kW + Ø 145 mm
- 1.4 kW

Comando **Stop-Go** di sospensione e riavvio cottura.

Led bianchi.

Comandi slider.

Fino a 9 livelli di potenza.

Limitatore di potenza programmabile su 8 livelli (1.0 - 1.5 - 2.8 - 3.5 - 3.7 - 4.5 - 6.0 - 7.4 kW).

Potenza massima 7.4 kW.

Programmazione digitale del tempo di cottura indipendente per ciascuna zona.

Funzione timer con allarme acustico.

Spegnimento automatico.

Rilevazione presenza pentola.

FINITURE



**Euro 1.825**

PVIU601BK

SICUREZZA

Indicatore calore residuo.

Blocco di sicurezza bambini.

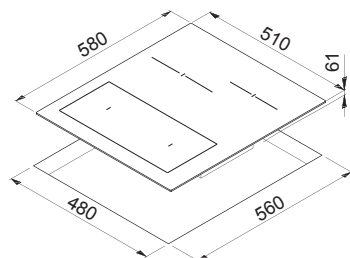

PLUS



**URBAN 30** **NEW**

30



Piano cottura a induzione in vetroceramica da 30 cm

CARATTERISTICHE

2 zone cottura con funzione **Bridge**

- 2 \* - 210 mm
- Comando **Stop-Go** di sospensione e riavvio cottura.
- Led bianchi.
- Comandi slider.
- Fino a 9 livelli di potenza.
- Limitatore di potenza programmabile su 8 livelli (1.0 - 1.5 - 2.8 - 3.5 - 3.7 kW).
- Potenza massima 3.7 kW.
- Programmazione digitale del tempo di cottura indipendente per ciascuna zona.
- Funzione timer con allarme acustico.
- Spegnimento automatico.
- Rilevazione presenza pentola.

Led bianchi.

Comandi slider.

Fino a 9 livelli di potenza.

Limitatore di potenza programmabile su 8 livelli (1.0 - 1.5 - 2.8 - 3.5 - 3.7 kW).

Potenza massima 3.7 kW.

Programmazione digitale del tempo di cottura indipendente per ciascuna zona.

Funzione timer con allarme acustico.

Spegnimento automatico.

Rilevazione presenza pentola.

FINITURE



**Euro 1.230**

PVIU301BK

SICUREZZA

Indicatore calore residuo.

Blocco di sicurezza bambini.

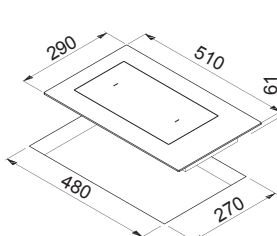

PLUS



COLLEZIONE  
**PIANI**  
GAS ON GLASS

**URBAN 90** **NEW**

90



Piano cottura a gas in cristallo temperato da 90 cm

#### CARATTERISTICHE

5 Bruciatori a gas

- 1 Ausiliario 1 kW
- 2 Semirapido 1,75 kW
- 1 Rapido 2 kW

• **1 Bruciatore Wok 4 kW posizione laterale sinistra**

Griglie d'appoggio e copri-spartifiamma in ghisa per una migliore trasmissione del calore senza sprechi e dispersioni. Manopole nere soft touch per una migliore piacevolezza d'uso.

**Step Flame Control:** 9 livelli di potenza per il minimo spreco energetico.

Accensione elettrica sottomanopola. Kit ugelli GPL in dotazione.

#### FINITURE



**Black**  
K86

**Euro 1.050**

PVGU901BK

#### SICUREZZA

Termovalvola di sicurezza.

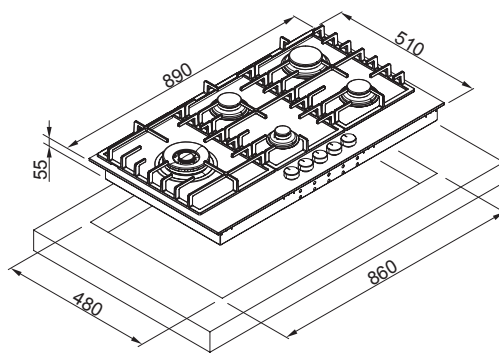

#### PLUS



**GRIGLIE IN GHISA**



**STEP FLAME CONTROL**



**MANOPOLE NERE SOFT TOUCH**



**BRUCIATORE WOK**

#### PLUS





**URBAN 75** NEW

75



Piano cottura a gas in cristallo temperato da 75 cm

CARATTERISTICHE

- 5 Bruciatori a gas
- 1 Ausiliario 1 kW
- 2 Semirapido 1,75 kW
- 1 Rapido 2 kW
- **1 Bruciatore Wok 4 kW posizione laterale sinistra**

Griglie d'appoggio e copri-spartifiamma in ghisa per una migliore trasmissione del calore senza sprechi e dispersioni. Manopole nere soft touch per una migliore piacevolezza d'uso.

**Step Flame Control:** 9 livelli di potenza per il minimo spreco energetico. Accensione elettrica sottomanopola. Kit ugelli GPL in dotazione.

FINITURE



**Black**  
K86

Euro 998

PVGU751BK

SICUREZZA

Termovalvola di sicurezza.

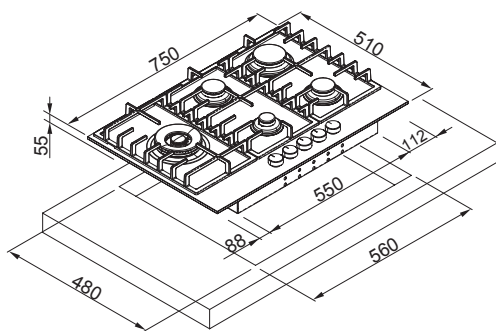

PLUS



**URBAN 60** NEW

60



Piano cottura a gas in cristallo temperato da 60 cm

CARATTERISTICHE

- 4 Bruciatori a gas
- 1 Ausiliario 1 kW
- 2 Semirapido 1,75 kW
- 1 Rapido 3 Kw

Griglie d'appoggio e copri-spartifiamma in ghisa per una migliore trasmissione del calore senza sprechi e dispersioni. Manopole nere soft touch per una migliore piacevolezza d'uso.

**Step Flame Control:** 9 livelli di potenza per il minimo spreco energetico. Accensione elettrica sottomanopola. Kit ugelli GPL in dotazione.

FINITURE



**Black**  
K86

Euro 775

PVGU601BK

SICUREZZA

Termovalvola di sicurezza.

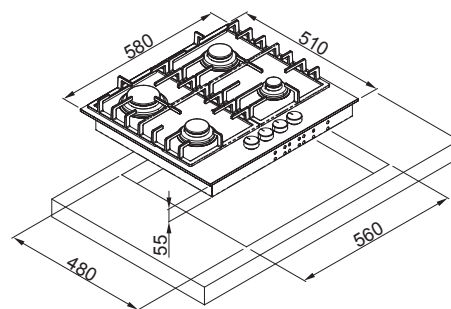

PLUS



## PLANO PLUS 75

75



Piano cottura a gas smaltato da 75 cm

### CARATTERISTICHE

5 Bruciatori a gas

- 1 Ausiliario 1 kW
- 2 Semirapido 1,75 kW
- 1 Rapido 3 kW

• **1 Bruciatore Wok 4 kW posizione centrale**

Griglie d'appoggio e copri-spartifiamma in ghisa per una migliore trasmissione del calore senza sprechi e dispersioni.

Manopole nere soft touch per una migliore piacevolezza d'uso.

**Step Flame Control:** 9 livelli di potenza per il minimo spreco energetico.

**FLAT BURNER FULL BLACK.**

Accensione elettrica integrata sottomanopola.

Kit ugelli GPL in dotazione.

### SICUREZZA

Termovalvola di sicurezza.

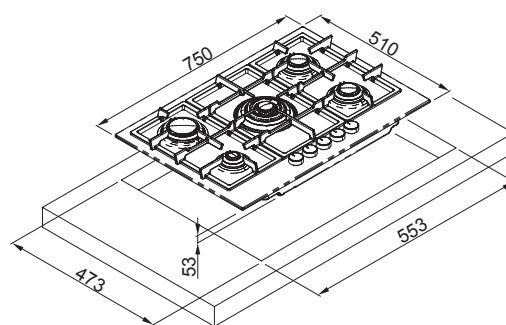

PLUS



COLORI\*

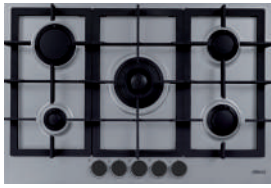

**Euro 1.030**

● **Light Grey** PKPP75197CS  
K97



**Euro 1.030**

○ **White** PKPP75196CS  
K96

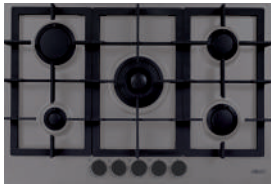

**Euro 1.030**

● **Dove Grey** PKPP75193CS  
K93



**Euro 1.030**

● **Black** PKPP75186CS  
K86



**Euro 1.030**

○ **Bianco** PGPP75168CS  
G68



**Euro 1.030**

● **Nero** PGPP75140CS  
G40

PLUS



**GRIGLIE IN GHISA**



**STEP FLAME CONTROL**



**FLAT BURNER**



**ACCENSIONE INTEGRATA SOTTOMANOPOLA**



**CORONA WOK**

Bruciatore doppia corona Wok



Manopole nere soft touch



\*Colori abbinabili ai materiali Keratek e Granitek

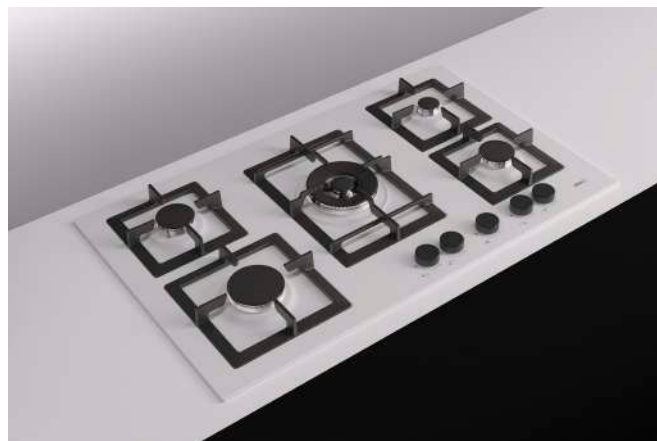

Piano cottura a gas smaltato da 90 cm

CARATTERISTICHE

5 Bruciatori a gas

- 1 Ausiliario 1 kW
- 2 Semirapido 1,75 kW
- 1 Rapido 3 kW

• **1 Bruciatore Wok 4 kW posizione centrale**

Griglie d'appoggio e copri-spartifiamma in ghisa per una migliore trasmissione del calore senza sprechi e dispersioni.

Manopole nere soft touch per una migliore piacevolezza d'uso.

Accensione elettrica integrata sottomanopola.

Kit ugelli GPL in dotazione.

SICUREZZA

Termovalvola di sicurezza.

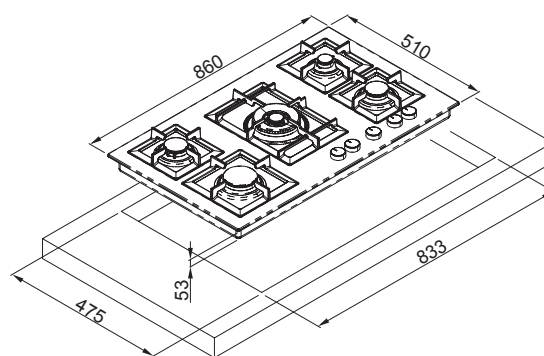

PLUS



COLORI\*



**Euro 748**

**Bianco**  
G68

PGSP90168CS



**Euro 748**

**Nero**  
G40

PGSP90140CS

**PLUS**



**GRIGLIE IN  
GHISA**



**ACCENSIONE INTEGRATA  
SOTTOMANOPOLA**



**CORONA  
WOK**

Griglie in ghisa



Manopole nere soft touch



\*Colori abbinabili ai materiali Keratek e Granitek

# PLANO 75

75



Piano cottura a gas smaltato da 75 cm

## CARATTERISTICHE

5 Bruciatori a gas

- 1 Ausiliario 1 kW
- 2 Semirapido 1,75 kW
- 1 Rapido 3 kW

• **1 Bruciatore Wok 4 kW posizione centrale**

Accensione sottomanopola

Griglie d'appoggio e copri-spartifiamma in ghisa per una migliore trasmissione del calore senza sprechi e dispersioni.

Manopole nere soft touch per una migliore piacevolezza d'uso.

Accensione elettrica integrata sottomanopola.

Kit ugelli GPL in dotazione.

## SICUREZZA

Termovalvola di sicurezza.

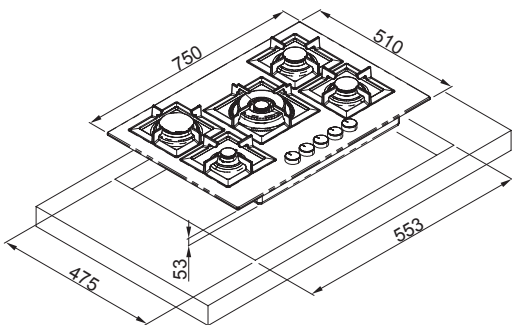

## PLUS



## COLORI\*

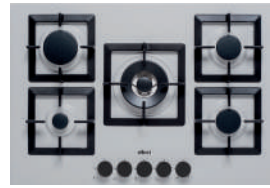

**Euro 690**

Aluminium PMSP75179CS  
M79



**Euro 690**

Titanium PMSP75173CS  
M73



**Euro 674**

Bianco PGSP75168CS  
G68



**Euro 674**

Avena PGSP75151CS  
G51



**Euro 674**

Tortora PGSP75143CS  
G43



**Euro 674**

Nero PGSP75140CS  
G40

## FINITURE



**Euro 680**

Inox PIAP751INCS  
IN

\*Colori abbinabili ai materiali Granitek

# PLANO 60

60

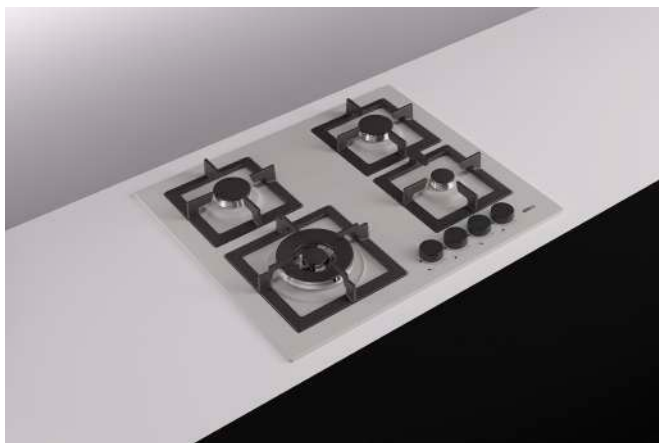

Piano cottura a gas smaltato da 60 cm

## CARATTERISTICHE

4 Bruciatori a gas

- 1 Ausiliario 1 kW
- 2 Semirapido 1,75 kW

• **1 Bruciatore Wok 3.1 kW posizione laterale sinistra**

Griglie d'appoggio e copri-spartifiamma in ghisa per una migliore trasmissione del calore senza sprechi e dispersioni.

Manopole nere soft touch per una migliore piacevolezza d'uso.

Accensione elettrica sottomanopola.

Kit ugelli GPL in dotazione.

## SICUREZZA

Termovalvola di sicurezza.

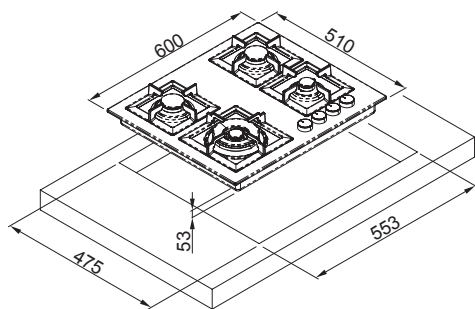

## PLUS



## COLORI\*



**Euro 617**

● **Aluminium** PMSP60179WS  
M79



**Euro 617**

● **Titanium** PMSP60173WS  
M73



**Euro 602**

● **Bianco** PGSP60168WS  
G68



**Euro 602**

● **Avena** PGSP60151WS  
G51

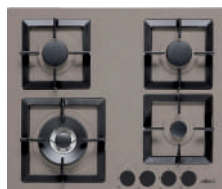

**Euro 602**

● **Tortora** PGSP60143WS  
G43



**Euro 602**

● **Nero** PGSP60140WS  
G40

## FINITURE



**Euro 608**

● **Inox** PIAP601INWS  
IN

\*Colori abbinabili ai materiali Granitek

## STYLE 75

75



Piano cottura a gas smaltato da 75 cm

### CARATTERISTICHE

5 Bruciatori a gas

- 1 Ausiliario 1 kW
- 2 Semirapido 1,75 kW
- 1 Rapido 3 kW

• **1 Bruciatore Wok 4 kW posizione centrale.**

Griglie lamellari.

Manopole nere soft touch per una migliore piacevolezza d'uso.

Accensione elettrica integrata sottomanopola.  
Kit ugelli GPL in dotazione.

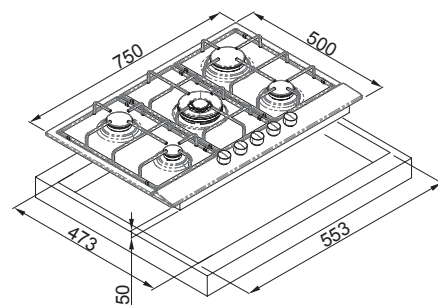

### SICUREZZA

Termovalvola di sicurezza.

### COLORI\*



**Euro 626**

○ **Bianco** PGSS75368CB  
G68



**Euro 626**

● **Antracite** PGSS75359CB  
G59



**Euro 626**

● **Avena** PGSS75351CB  
G51



**Euro 626**

● **Cemento** PGSS75348CB  
G48

### PLUS



\* Colori abbinabili ai materiali Granitek



# STYLE 60

60

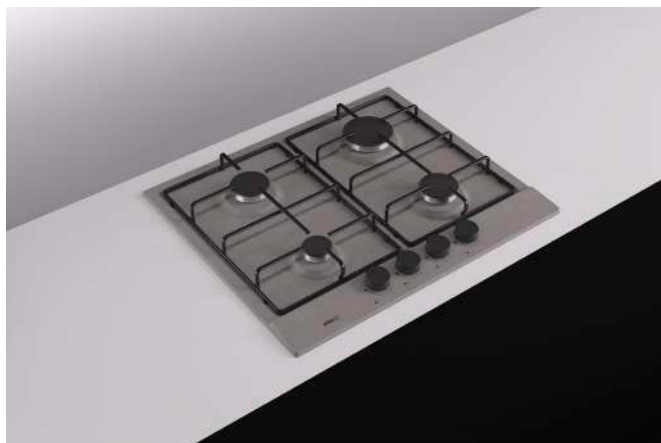

Piano cottura a gas smaltato da 60 cm

### CARATTERISTICHE

- 4 Bruciatori a gas
  - 1 Ausiliario 1 kW
  - 2 Semirapido 1,75 kW
  - 1 Rapido 3 kW
- Griglie lamellari.  
Manopole nere soft touch per una migliore piacevolezza d'uso.  
Accensione elettrica integrata sottomanopola.  
Kit ugelli GPL in dotazione.

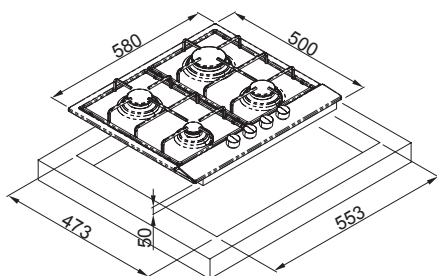

### SICUREZZA

Termovalvola di sicurezza.

### COLORI\*

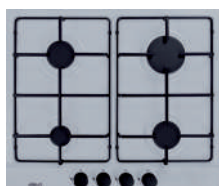

**Euro 495**

**Bianco** PGSS60268WB  
G68



**Euro 495**

**Antracite** PGSS60259WB  
G59



**Euro 495**

**Avena** PGSS60251WB  
G51



**Euro 495**

**Cemento** PGSS60248WB  
G48

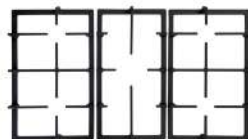

Griglie in ghisa Style 75

**Euro 214**

AKG03303

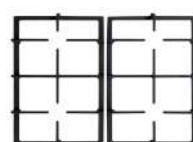

Griglie in ghisa Style 60

**Euro 146**

AKG01304

### PLUS



ACCENSIONE INTEGRATA  
SOTTOMANOPOLA



VALVOLA DI  
SICUREZZA



CORONA  
WOK

### PLUS



\*Colori abbinabili ai materiali Granitek



Piano cottura a gas smaltato da 90 cm

CARATTERISTICHE

- 5 Bruciatori a gas
- 1 Ausiliario 1 kW
  - 2 Semirapido 1,75 kW
  - 1 Rapido 3 kW

- **1 Bruciatore Wok 4 kW posizione centrale**

Griglie d'appoggio e copri-spartifiamma in ghisa per una migliore trasmissione del calore senza sprechi e dispersioni. Manopole nere soft touch per una migliore piacevolezza d'uso. Accensione elettrica sottomanopola. Kit ugelli GPL in dotazione.

COLORI\*

 **Avena**  
G51

**Euro 710**

PGCO90151WS

SICUREZZA

Termovalvola di sicurezza.

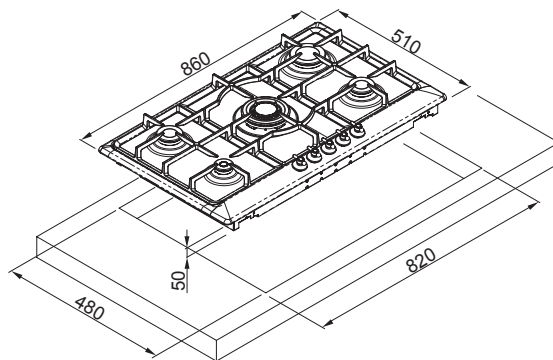

PLUS



\* Colori abbinabili ai materiali Granitek

# COUNTRY 75 NEW

75



Piano cottura a gas smaltato da 75cm

## CARATTERISTICHE

5 Bruciatori a gas

- 1 Ausiliario 1 kW
- 2 Semirapido 1,75 kW
- 1 Rapido 3 kW

• **1 Bruciatore Wok 4 kW posizione laterale sinistra**

Griglie d'appoggio e copri-spartifiamma in ghisa per una migliore trasmissione del calore senza sprechi e dispersioni. Manopole nere soft touch per una migliore piacevolezza d'uso. Accensione elettrica sottomanopola. Kit ugelli GPL in dotazione.

## COLORI\*

**Avena**  
G51

## Euro 698

PGCO75151WS

## SICUREZZA

Termovalvola di sicurezza.

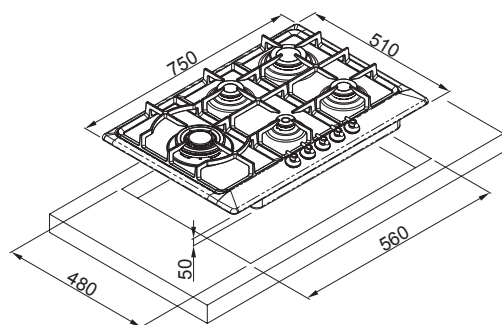

## PLUS



\*Colori abbinabili ai materiali Granitek

## PLUS



**GRIGLIE IN GHISA**



**ACCENSIONE INTEGRATA SOTTOMANOPOLA**



**CORONA WOK**

COLLEZIONE  
**FORNI**  
URBAN



**PLUS**

-  **PORTA FREDDA**
-  **VETRO PORTA REMOVIBILE**
-  **CAVITÀ XXL**
-  **DISPLAY LED BIANCHI**
-  **MANOPOLE SOFT TOUCH**
-  **TOTAL BLACK GLASS**
-  **MULTI FUNCTION**
-  **TOUCH CONTROL**

**URBAN PLUS** NEW



Forno elettrico termoventilato 9 funzioni total black glass

CARATTERISTICHE

Classe energetica A.  
 Funzione **Steam Cleaning** pulizia a vapore.  
 Programmazione digitale 6 tasti led bianchi.  
 2 manopole nere soft touch per una migliore piacevolezza d'uso.  
 Maniglia total black.  
**Cavità XXL** Black 80 litri easy to clean.  
 6 livelli di cottura.  
 1 griglia + 1 leccarda.  
 Luce forno.  
 Guide cromate laterali.  
 Porta interna removibile.

**COLORI\***

 **Black**  
BK

**Euro 892**

FVUP601BKNB

SICUREZZA

Porta fredda con triplo vetro.  
 Ventilazione tangenziale di raffreddamento.

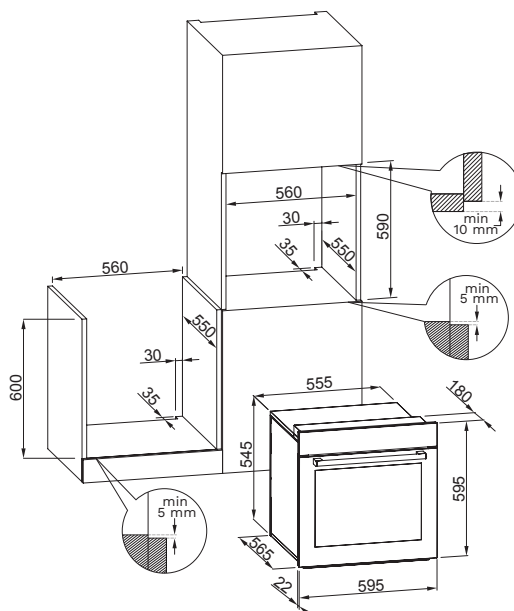

FUNZIONI



PLUS



**URBAN** NEW



Forno elettrico multifunzione 8 funzioni total black glass

CARATTERISTICHE

Classe energetica A.  
 Timer meccanico.  
 3 manopole nere soft touch per una migliore piacevolezza d'uso.  
 Maniglia total black.  
**Cavità XXL** Black 80 litri easy to clean.  
 6 livelli di cottura.  
 1 griglia + 1 leccarda.  
 Luce forno.  
 Guide cromate laterali.  
 Porta interna removibile.

**COLORI\*** **Euro 711**

**Black** FVUR601BKNB  
 BK

SICUREZZA

Porta fredda con triplo vetro.  
 Ventilazione tangenziale di raffreddamento.

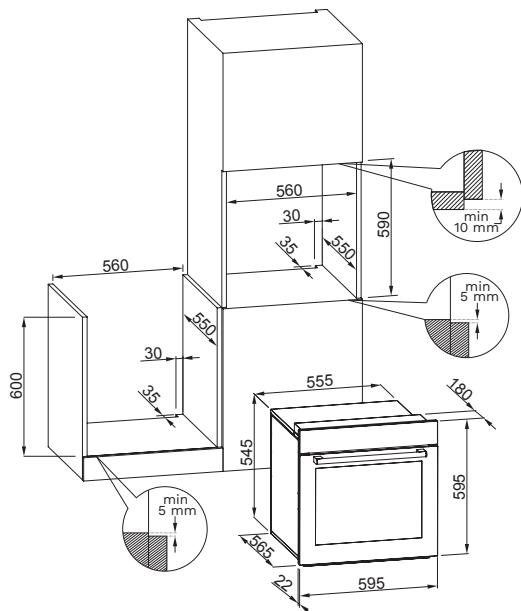

FUNZIONI

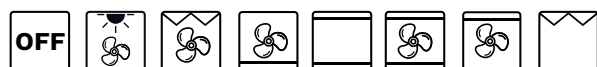

PLUS



**URBAN MW** NEW



Forno microonde multifunzione total black glass

CARATTERISTICHE

Capacità 28 L.  
 Apertura porta a Sinistra.  
 Programmatore elettronico con display digitale led bianchi.  
 Cottura grill/combinata.  
 Scongelo automatico in base a tempo e peso.  
 Pulsante di avvio rapido.  
 Piatto in vetro.  
 Piatto girevole diametro 288 mm.  
 Blocco di sicurezza.  
 Griglia microonde.  
 Touch Control.

**COLORI\*** **Euro 768**

**Black** FVUR281BKWS  
 BK

SICUREZZA

Funzione blocco bambini.

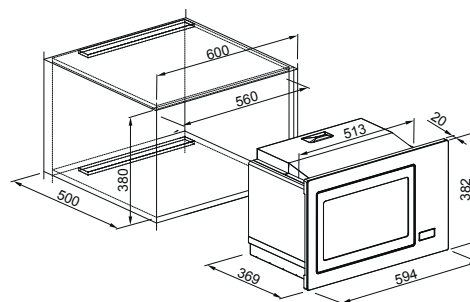

FUNZIONI



PLUS



FORNI



## PLANO PLUS NEW



Forno elettrico termoventilato 9 funzioni

### CARATTERISTICHE

Classe energetica A.

Funzione **Steam Cleaning** pulizia a vapore.  
Programmazione digitale 6 tasti led bianchi.

2 manopole nere soft touch per una migliore piacevolezza d'uso.  
Maniglia total black.

**Cavità XXL** Black 80 litri easy to clean.

6 livelli di cottura.

1 griglia + 1 leccarda.

Luce forno.

Guide cromate laterali.

Porta interna removibile.

Cornice frontale forno in colore.

### SICUREZZA

Porta fredda con triplo vetro.

Ventilazione tangenziale di raffreddamento.

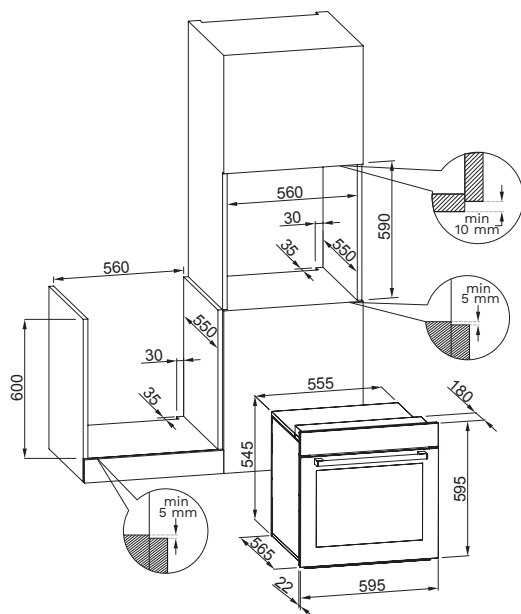

### FUNZIONI



### PLUS



COLORI\*



**Euro 972**

● **Light Grey** FKPP60297NS  
K97



**Euro 972**

○ **White** FKPP60296NS  
K96



**Euro 972**

● **Dove Grey** FKPP60293NS  
K93



**Euro 972**

● **Black** FKPP60286NS  
K86



**Euro 972**

● **Aluminium** FMPP60279NS  
M79



**Euro 972**

● **Titanium** FMPP60273NS  
M73



**Euro 972**

○ **Bianco** FGPP60268NS  
G68



**Euro 972**

● **Avena** FGPP60251NS  
G51



**Euro 972**

● **Tortora** FGPP60243NS  
G43



**Euro 972**

● **Nero** FGPP60240NS  
G40

FINITURE



**Euro 926**

● **Inox** FIPP602INNS  
IN

\*Colori abbinabili ai materiali Keratek e Granitek

PLUS



**PORTA FREDDA**



**VETRO PORTA REMOVIBILE**



**CAVITÀ XXL**



**DISPLAY LED BIANCHI**



**MANOPOLE SOFT TOUCH**

COLLEZIONE  
**FORNI**  
PLANO



**PLANO** NEW



Forno elettrico multifunzione 8 funzioni

CARATTERISTICHE

Classe energetica A.  
Timer meccanico.  
3 manopole nere soft touch per una migliore piacevolezza d'uso.  
Maniglia total black.  
**Cavità XXL** Black 80 litri easy to clean.  
6 livelli di cottura.  
1 griglia + 1 leccarda.  
Luce forno.  
Guide cromate laterali.  
Porta interna removibile.  
Cornice frontale forno in colore.

SICUREZZA

Porta fredda con triplo vetro.  
Ventilazione tangenziale di raffreddamento.

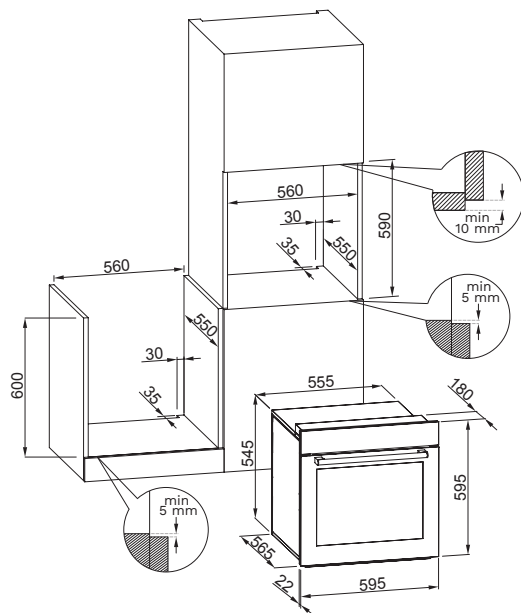

FUNZIONI

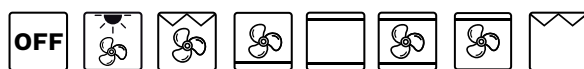

PLUS





COLORI\*



euro 791

**Aluminium** FMSP60279NS  
M79



euro 791

**Titanium** FMSP60273NS  
M73



euro 791

**Bianco** FGSP60268NS  
G68



euro 791

**Avena** FGSP60251NS  
G51



euro 791

**Tortora** FGSP60243NS  
G43



euro 791

**Nero** FGSP60240NS  
G40

FINITURE



euro 740

**Inox** FIAP602INNS  
IN

\*Colori abbinabili ai materiali Granitek

PLUS



**PORTA FREDDA**



**VETRO PORTA REMOVIBILE**



**CAVITÀ XXL**



**MANOPOLE SOFT TOUCH**

## PLANO MW



Forno microonde multifunzione 10 funzioni

### CARATTERISTICHE

Capacità 28 L.  
Apertura porta a Sinistra.  
Programmatore elettronico con display digitale led bianchi.  
Cottura grill/combinata.  
Scongelamento automatico in base a tempo e peso.  
Pulsante di avvio rapido.  
Piatto in vetro.  
Piatto girevole diametro 315 mm.  
Blocco di sicurezza.  
Griglia microonde.  
Cornice frontale forno in colore.

### SICUREZZA

Funzione blocco bambini.

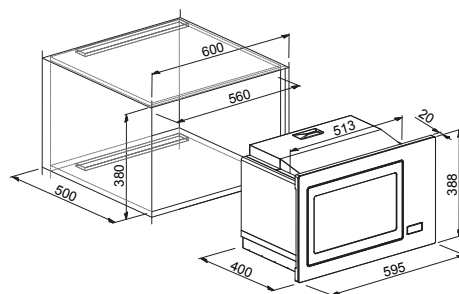

### FUNZIONI



### PLUS



**PLUS**



DISPLAY  
LED BIANCHI



10 PROGRAMMI

COLORI\*



euro 768

● **Light Grey** FKSP28197WS  
K97



euro 768

○ **White** FKSP28196WS  
K96



euro 768

● **Dove Grey** FKSP28193WS  
K93



euro 768

● **Black** FKSP28186WS  
K86



euro 768

● **Aluminium** FMSP28179WS  
M79



euro 768

● **Titanium** FMSP28173WS  
M73



euro 768

○ **Bianco** FGSP28168WS  
G68



euro 768

● **Avena** FGSP28151WS  
G51



euro 768

● **Antracite** FGSP28159WS  
G59



euro 768

● **Cemento** FGSP28148WS  
G48



euro 768

● **Tortora** FGSP28143WS  
G43



euro 768

● **Nero** FGSP28140WS  
G40

FINITURE



euro 657

● **Inox** FIAP281INWS  
IN

\*Colori abbinabili ai materiali Keratek e Granitek

COLLEZIONE  
**FORNI**  
COUNTRY



**PLUS**



**PORTA FREDDA**



**VETRO PORTA REMOVIBILE**



**CAVITÀ XXL**



**MANOPOLE E MANIGLIE OTTONATE**

**COUNTRY** **NEW**



Forno elettrico multifunzione 8 funzioni

**CARATTERISTICHE**

Classe energetica A.  
Timer analogico.  
Maniglia finitura ottone antico.  
**Cavità XXL** Black 80 litri easy to clean.  
6 livelli di cottura.  
1 griglia + 1 leccarda.  
Luce forno.  
Guide cromate laterali.  
Porta interna removibile.

**COLORI\***

**Euro 785**



**Avena**  
G51

FGC060151NS

**SICUREZZA**

Porta fredda con triplo vetro.  
Ventilazione tangenziale di raffreddamento.

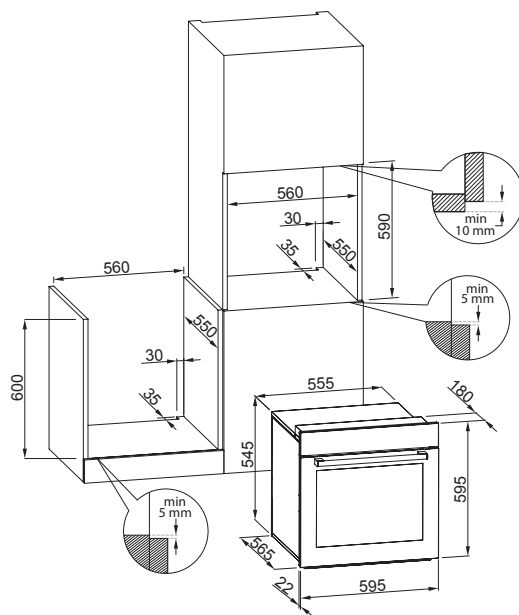

**FUNZIONI**



**PLUS**



\*Colori abbinabili ai materiali Granitek



COLLEZIONE  
**CAPPE**



## BRIO



Cappa aspirante smaltata

### CARATTERISTICHE

Dimensioni (mm) **782 x 372 x 490**  
 Comandi **Slider**  
 Numero Velocità **3**  
 Portata Massima **368 m3/h**  
 Pressione **218 Pa**  
 Rumorosità Massima **58 dbA**  
 Bocca Uscita **120**  
 Classe Energetica **D**

### COLORI\* Euro 841

● Nero G40 KGPB8040M

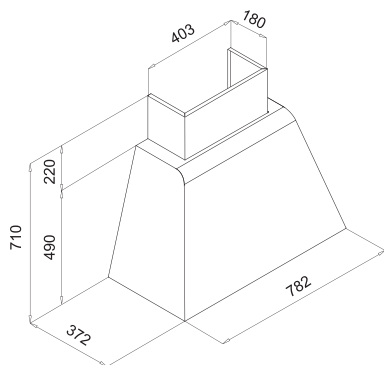

**Accessorio**  
**filtro carbone Euro 90**

AFC01304

## URBAN



Cappa aspirante smaltata

### CARATTERISTICHE

Dimensioni (mm) **Ø 493 x h 406**  
 Comandi **Slider**  
 Numero Velocità **3**  
 Portata Massima **520 m3/h**  
 Pressione **151 Pa**  
 Rumorosità Massima **65 dbA**  
 Bocca Uscita **120**  
 Classe Energetica **D**

### COLORI\* Euro 723

● Nero G40 KGPUR040M

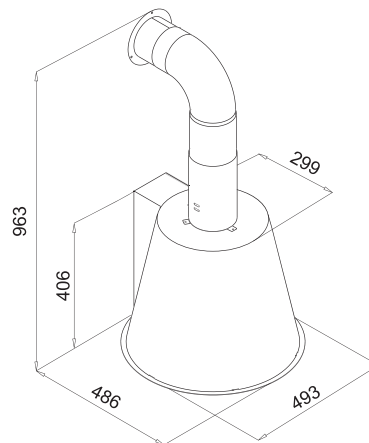

**Accessorio**  
**filtro carbone Euro 90**

AFC01305

\*Colori abbinabili ai materiali Granitek

COLLEZIONE  
**DISSIPATORI**

**2 ANNI - YEARS  
WARRANTY**  
**GARANTITO**

Il dissipatore di rifiuti alimentari (DRA) è un moderno elettrodomestico essenziale che ci libera dai rifiuti organici e rende la nostra vita più facile in cucina. È sufficiente premere un solo pulsante e il cibo verrà triturato e smaltito. Facile da installare, non ingombrante, silenzioso e sicuro. I rifiuti vengono ridotti in piccole particelle e scaricati nel sistema fognario attraverso l'acqua.

**VANTAGGI**

Niente più cattivi odori  
Risparmio economico  
Riduzione dei rifiuti da smaltire  
Ambiente più sano  
Riduzione CO2

**PIÙ SILENZIOSO DEL 40%**

Tutti i dissipatori Elleci sono progettati per ridurre al minimo il coefficiente di vibrazione e la rumorosità. Con la combinazione di questi due fattori i dissipatori Elleci sono più silenziosi del 40% rispetto ai prodotti tradizionali.

**GRANDE CAMERA DI DISSIPAZIONE**

Una cavità volumetrica maggiore comporta un minor rischio di intasamento e una migliore triturazione.

ATTRAVERSO QUESTO ELETTRODOMESTICO È POSSIBILE SMALTIRE RIFIUTI ORGANICI QUALI: FRUTTA, VERDURA, LISCE DI PESCE, GUSCI, OSSA DI POLLO E MOLTI ALTRI.

Non è possibile smaltire cibi fibrosi quali: carciofi, finocchi, ananas, ecc.

## STAINLESS STEEL HIGH QUALITY PARTS

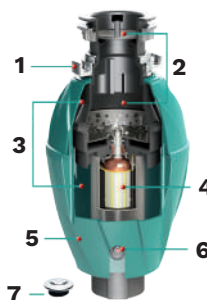

- 1 Installazione facile e veloce
- 2 Protezione Antibatterica e Sistema Antiodore
- 3 Componenti in acciaio inox
- 4 Motore a corrente diretta ad elevata potenza
- 5 Innovativo Design Italiano
- 6 Sistema Reset di Sicurezza
- 7 Interruttore pneumatico ad aria incluso



## 1000 TOP

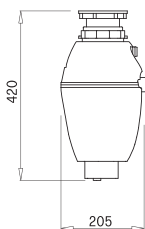

**4.8**  
KG

### CARATTERISTICHE

Dimensioni (mm)  
205 X 420  
Deluxe 1 Hp  
TDH01000  
Euro **510**

Potenza Watt: 750  
Tensione VAC: 220/240  
Assorbimento: 3,4  
r/min.: 2800  
Peso: 4,8  
Capacità: 1070 ml.

### ACCESSORI INCLUSI



GOMITO DI FISSAGGIO



GOMMA PARASPRUZZI  
REMOVIBILE E LAVABILE  
(ANCHE IN LAVASTOVIGLIE)



SPINGITORE RIFIUTI



TAPPO  
STANDARD



AIR SWITCH:  
ATTUATORE PNEUMATICO  
(PULSANTE DI ACCENSIONE  
AD ARIA, NON ELETTRONICO)

### ACCESSORI CONSIGLIATI



FLANGIA DISSIPATORE  
PER PILETTA QUADRATA  
Pag. 203



RADIOCOMANDO  
ACCENSIONE  
Pag. 203

## 750 TOP

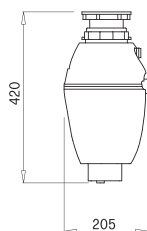

**4.7**  
KG

### CARATTERISTICHE

Dimensioni (mm)  
205 X 420  
3/4 HP  
TDH00750  
Euro **456**

Potenza Watt: 550  
Tensione VAC: 220/240  
Assorbimento: 2,5  
r/min.: 2800  
Peso: 4,7  
Capacità: 1070 ml.

## 750

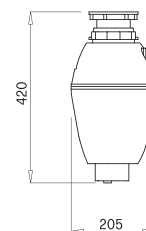

**4.5**  
KG

### CARATTERISTICHE

Dimensioni (mm)  
205 X 420  
3/4 HP  
TDM00750  
Euro **425**

Potenza Watt: 550  
Tensione VAC: 220/240  
Assorbimento: 2,5  
r/min.: 2800  
Peso: 4,5  
Capacità: 860 ml.

## 500 TOP

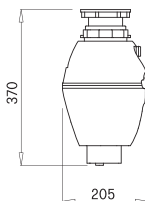

**4.5**  
KG

### CARATTERISTICHE

Dimensioni (mm)  
205 X 370  
1/2 HP  
TDH00500  
Euro **374**

Potenza Watt: 375  
Tensione VAC: 220/240  
Assorbimento: 1,7  
r/min.: 2800  
Peso: 4,5  
Capacità: 1070 ml.

## 500

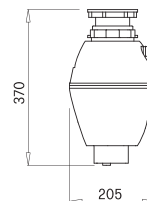

**4.3**  
KG

### CARATTERISTICHE

Dimensioni (mm)  
205 X 370  
1/2 HP  
TDM00500  
Euro **352**

Potenza Watt: 375  
Tensione VAC: 220/240  
Assorbimento: 1,7  
r/min.: 2800  
Peso: 4,3  
Capacità: 860 ml.



Una linea di prodotti, con specifiche caratteristiche, realizzati per facilitare le operazioni quotidiane di pulizia e cura delle superfici per mantenere nel tempo la bellezza dei prodotti Elleci.

elleci | BEAUTY



SCORPI DI PIÙ



DLL01602  
28 Euro  
0,2 LT/KG **NEW**

**DAILY CLEANER – SGRASSANTE**  
Detergente spray sgrassante, rimuove tracce di sporco, germi e batteri rispettando le superfici. È indicato per la pulizia periodica dei lavelli in composito Elleci.



DLC01603  
38 Euro  
0,2 LT/KG **NEW**

**DEEP CLEANER – EXTRA ACTION**  
Detergente in crema con azione smacchiante, rimuove le macchie più ostiche su tutti i lavelli Elleci in composito di colore chiaro.



DLA01603  
28 Euro  
0,2 LT/KG **NEW**

**DAILY CLEANER – ANTICALCARE**  
Detergente spray anticalcare, scioglie le incrostazioni rispettando le superfici. È indicato per una pulizia periodica dei lavelli Elleci in composito.



DLP01601  
30 Euro  
0,1 LT/KG **NEW**

**BEAUTY PROTECTOR**  
Detergente spray protettivo, salvaguarda da sporco, residui calcarei e mantiene la bellezza del prodotto nel tempo ravvivando la colorazione e aumentandone l'idrorepellenza.



**ESPOSITORE DA BANCO PRODOTTI PER LA PULIZIA**  
Un comodo box impilabile in cartone disponibile su richiesta.



DLA01602  
30 Euro  
0,25 LT/KG

**DAILY CLEANER – CLEAN POWER**  
Detergente spray di pulizia specifico per superfici colorate e smaltate. È indicato per una pulizia quotidiana dei miscelatori e degli elettrodomestici colorati Elleci.



DKP01000  
18 Euro

**FAST CLEAN – KIT SPUGNE**  
Kit composto da 3 spugne antigraffio dotate di doppio strato utile a rimuovere lo sporco, anche il più intenso. La parte bianca agisce senza graffiare le superfici delicate, mentre la parte blu più morbida, ha un potere assorbente.



DKP01001  
24 Euro

**FAST CLEAN – PANNI IN MICROFIBRA**  
Kit composto da 2 panni in microfibra con speciale motivo a scacchiera ad alta assorbenza per lasciare asciutto il lavello e togliere ogni residuo lasciando inalterata la superficie.

# CURA E MANUTENZIONE



Mantenere nel tempo l'estetica e la funzionalità del prodotto è estremamente semplice. È sufficiente pulire ed asciugare quotidianamente utilizzando detergenti neutri o specifici della linea **Elleci Beauty** senza lasciare che depositi e residui agiscano a lungo sulle superfici.



ULTERIORI  
AVVERTENZE  
E CONSIGLI



Rimuovere eventuali macchie utilizzando una spugna morbida e un detergente neutro per i piatti o un prodotto specifico della linea Elleci Beauty.



Risciacquare abbondantemente le superfici utilizzando acqua tiepida.



















Asciugare con cura la superficie con un panno morbido o in microfibra per impedire la formazione di depositi di calcare.



Per prevenire la formazione delle macchie di calcare sulla superficie, si raccomanda di eseguire una pulizia più approfondita una o due volte alla settimana utilizzando un detergente anticalcare disincrostante come lo spray anticalcare Daily Clean della linea Elleci Beauty.

# SPARE PARTS

	<b>SET PILETTA FLOW PRO INOX, UNA VIA</b> SCARICO PILETTA UNA VIA DA 3-1/2" CON TAPPO CESTELLO FLOW PRO INOX E TUBO CORRUGATO, SENZA TROPPOPIENO	CODICE WPT90CTPLUXF	EURO 35,00
	<b>SET TROPPOPIENO RETTANGOLARE</b> TROPPOPIENO CON USCITA RETTANGOLARE SLIM E COVER INOX, COMPLETO DI ATTACCHI	CODICE KTSMELL	EURO 10,00
	<b>SET PILETTA FLOW PRO CON TROPPOPIENO SLIM NERO</b> SCARICO PILETTA UNA VIA DA 3-1/2" CON TAPPO CESTELLO FLOW PRO NERO E TUBO CORRUGATO CON TROPPOPIENO SLIM "ELLECI" NERO	CODICE KITWPT-F-1VSELL-BK	EURO 115,00
	<b>SET PILETTA FLOW PRO CON TROPPOPIENO SLIM GOLD</b> SCARICO PILETTA UNA VIA DA 3,1/2" CON TAPPO CESTELLO FLOW PRO GOLD E TUBO CORRUGATO CONTROPPOPIENO SLIM "ELLECI" GOLD	CODICE KITWPT-F-1VSELL-GD	EURO 95,00
	<b>TAPPO SCARICO FLOW PRO INOX</b> TAPPO CESTELLO FLOW PRO INOX SPAZZOLATO	CODICE TAPF01IN	EURO 25,00
	<b>TAPPO SCARICO FLOW PRO NERO</b> TAPPO CESTELLO FLOW PRO NERO	CODICE TAPF01BK	EURO 95,00
	<b>TAPPO SCARICO FLOW PRO GOLD</b> TAPPO CESTELLO FLOW PRO GOLD	CODICE TAPF01GD	EURO 70,00
	<b>SET PILETTA UNA VIA INOX</b> SCARICO PILETTA UNA VIA DA 3-1/2" CON TAPPO CESTELLO E TUBO CORRUGATO, SENZA TROPPOPIENO	CODICE WBB90CTPLUXR	EURO 10,00
	<b>SET PILETTA CHIUSA INOX</b> SCARICO PILETTA 3-1/2" CHIUSA CON TAPPO CESTELLO	CODICE WBB90STPLUXR	EURO 10,00
	<b>SET PILETTA UNA VIA, SCARICO QUADRATO</b> SCARICO PILETTA QUADRATA UNA VIA CON TUBO CORRUGATO, SENZA TROPPOPIENO	CODICE WPT90CTPLUXQ	EURO 40,00
	<b>SET PILETTA</b> SCARICO PILETTA CHIUSA DA 70mm, CON TAPPO CESTELLO, SET ESCLUSIVO PER LAVELLI EASY 325 e EASY 425	CODICE WPT70STPLUXA	EURO 12,00
	<b>SET TROPPOPIENO TONDO</b> TROPPOPIENO CON USCITA TONDA E COVER INOX, COMPLETO DI ATTACCHI	CODICE KTTMELL	EURO 8,00
	<b>SET SIFONERIA UNA VIA</b> SIFONE ISPEZIONABILE SALVASPAZIO A UNA VIA PER LAVELLI UNA VASCA	CODICE COMPSIF1V	EURO 8,00
	<b>SET SIFONERIA DUE VIE</b> SIFONE ISPEZIONABILE SALVASPAZIO A DUE VIE PER LAVELLI DUE VASCHE	CODICE COMPSIF2V	EURO 10,00
	<b>SET SIFONERIA DUE VIE SFASATE</b> SIFONE ISPEZIONABILE SALVASPAZIO A DUE VIE SFASATE, PER LAVELLI CON DUE VASCHE	CODICE COMPSIF2VU	EURO 10,00
	<b>SET GANCI SOPRATOP</b> N°6 GANCI FISSAGGIO AD INCLINAZIONE 23° CON VITI PREMONTATE E SPESSORI IN PLASTICA, PER FISSAGGIO LAVELLO COMPOSITO	CODICE BOXGAN06	EURO 12,00

LAVELLI IN COMPOSITO

	<p><b>SET GANCI SOPRATOP</b> N°6 GANCI FISSAGGIO AD INCLINAZIONE 90° CON VITI PREMONTATE E SPESSORI IN PLASTICA, PER FISSAGGIO LAVELLO COMPOSITO</p>	<p>CODICE BOXGAN06S</p>	<p>EURO 12,00</p>	<p>LAVELLI IN COMPOSITO</p>
	<p><b>SET GANCI SOTTOTOP</b> N°6 GANCI FISSAGGIO CON VITI PER LAVELLO COMPOSITO AD INSTALLAZIONE SOTTOTOP</p>	<p>CODICE AKS01301</p>	<p>EURO 18,00</p>	
	<p><b>FRESA PER FORATURA</b> FRESA A TAZZA DIAMANTATA, DIAMETRO 35mm PER EFFETTUARE FORO MISCELATORE SU LAVELLO COMPOSITO</p>	<p>CODICE FRES17</p>	<p>EURO 18,00</p>	
	<p><b>ESPOSITORE DA BANCO PRODOTTI PER LA PULIZIA</b> BOX CARTONE SET PRODOTTI PER LA PULIZIA</p>	<p>SU RICHIESTA</p>		
	<p><b>SET PILETTA QUADRATA UNA VIA CON TROPPOPIENO RETTANGOLARE</b> SCARICO PILETTA QUADRATO CON TUBO CORRUGATO E TROPPOPIENO RETTANGOLARE SLIM</p>	<p>CODICE COMPP90CTPLUXW</p>	<p>EURO 40,00</p>	<p>LAVELLI INOX</p>
	<p><b>SET PILETTA UNA VIA CON TROPPOPIENO RETTANGOLARE</b> SCARICO PILETTA 3-1/2" CON TUBO CORRUGATO E TROPPOPIENO RETTANGOLARE SLIM</p>	<p>CODICE COMPP90CTPLUXC</p>	<p>EURO 12,00</p>	
	<p><b>TAPPO</b> TAPPO DISSIPATORE TONDO</p>	<p>CODICE IKT90004</p>	<p>EURO 15,00</p>	<p>DISSIPATORI</p>
	<p><b>SET FLANGIA RACCORDO</b> FLANGIA DI RACCORDO PER DISSIPATORE ELLECI CON GUARNIZIONI, PARASCHIZZI IN GOMMA, ANELLO E GHIERA DI FISSAGGIO</p>	<p>CODICE IKT90001</p>	<p>EURO 20,00</p>	
	<p><b>FLANGIA DI RACCORDO QUADRATA PER DISSIPATORE ELLECI</b> PER LAVELLI CON SCARICO QUADRATO</p>	<p>CODICE ATQ01300</p>	<p>EURO 38,00</p>	
	<p><b>FLANGIA MAGGIORATA</b> FLANGIA DI RACCORDO CON FILETTATURA AUMENTATA, PER INSTALLAZIONE DISSIPATORE SU SUPERFICI CON SPESSORE MAGGIORATO</p>	<p>CODICE MLT90007</p>	<p>EURO 65,00</p>	
	<p><b>SET GOMITO FISSAGGIO</b> GOMITO DI FISSAGGIO CON GUARNIZIONI</p>	<p>CODICE IKT90003</p>	<p>EURO 18,00</p>	
	<p><b>SET PULSANTE PNEUMATICO</b> PULSANTE PNEUMATICO CON TUBO IN GOMMA E DADO DI FISSAGGIO, PER L'ACCENSIONE DEL DISSIPATORE</p>	<p>CODICE IKT90002</p>	<p>EURO 30,00</p>	
	<p><b>PARASCHIZZI</b> PARASCHIZZI IN GOMMA CON ALETTE</p>	<p>CODICE PPT90010</p>	<p>EURO 10,00</p>	
	<p><b>RADICOMANDO</b> RADIOCOMANDO ACCENSIONE DISSIPATORE</p>	<p>CODICE ARP01300</p>	<p>EURO 84,00</p>	
	<p><b>SPINGITORE RIFIUTI</b> SPINGITORE RIFIUTI IN PLASTICA</p>	<p>CODICE PPT90000</p>	<p>EURO 18,00</p>	
	<p><b>MANOPOLA SILVER</b> MANOPOLA SILVER PER PIANI COTTURA PLANO</p>	<p>CODICE AMP06300</p>	<p>EURO 13,00</p>	<p>PIANI C.</p>

# ELLECI È SEMPRE PIÙ VICINA A TE

Elleci ha cura dei propri clienti e lo dimostra utilizzando i materiali più innovativi e le tecnologie più all'avanguardia per offrire il massimo della qualità.

Qualità certificata da precise norme di produzione, conformi a ISO 9001:2015, ISO 14001:2015 e ISO 45001:2018.

Elleci ti assicura una garanzia della durata variabile, a seconda della categoria del prodotto che hai scelto.

Tali durate sono indicate nei rispettivi manuali di utilizzo/installazione.

PRODOTTO	GARANZIA
LAVELLI COMPOSITO GARANZIA 2 ANNI* _ KERATEK	<b>20 ANNI</b>
LAVELLI COMPOSITO GARANZIA 2 ANNI* _ GRANITEK	<b>10 ANNI</b>
LAVELLI INOX / MISCELATORI / ELETTRODOMESTICI / ACCESSORI	<b>2 ANNI</b>
DISSIPATORI	<b>2 ANNI</b>

\* Elleci offre ai suoi clienti la possibilità, previa registrazione prodotto, di usufruire anche della garanzia convenzionale (oltre quella legale) di 10 anni per i lavelli in Granitek e 20 anni per i lavelli in Keratek.

## MODALITÀ DI ASSISTENZA TECNICA

### LAVELLI | MISCELATORI | ACCESSORI | DISSIPATORI

In caso di assistenza tecnica su lavelli in composito, lavelli inox, miscelatori, accessori e dissipatori, e dopo l'inserimento dei necessari dati e documentazioni, il Customer Care elaborerà la pratica, fornendoti riscontro entro le 48 ore successive.

Se la pratica rientra in garanzia, essa verrà conclusa nell'arco dei 7 giorni successivi alla data dell'invio della mail con la comunicazione dell'esito della pratica stessa.

### PIANI COTTURA | FORNI | CAPPE

In caso di segnalazioni riguardanti gli elettrodomestici (piani cottura, forni e cappe), esse verranno gestite tramite circa 350 centri di assistenza tecnica (CAT) da noi appositamente incaricati. Anche in questo caso, dopo aver fornito i necessari dati e documentazioni, il Customer Care Elleci prenderà contatto con te entro le 48 ore successive alla segnalazione per definire e concordare le successive tempistiche di uscita e/o di risoluzione pratica.

UN NUOVO NUMERO VERDE  
A TUA DISPOSIZIONE,  
UN NUOVO SERVIZIO DI ASSISTENZA  
PRE E POST-VENDITA

Elleci ha potenziato il suo Customer Care, un vero e proprio team di professionisti pronto ad offrirti un servizio ancora più tempestivo ed efficiente. Un solo numero verde per gestire tutte le richieste, attivo dal lunedì al venerdì dalle 8.30 alle 13.00 e dalle 14.00 alle 17.30, e raggiungibile sia da numero fisso sia da smartphone.











Il Customer Care Elleci sarà al tuo fianco in modo rapido e affidabile, provvedendo a trovare la soluzione più idonea per garantire la tua piena soddisfazione.

**NUMERO VERDE**  
**800 800 803**











Per maggiori informazioni  
visita il sito [www.elleci.com](http://www.elleci.com)

**LAVELLI**



-  Base
-  Base  
SE INIZIO COMPOSIZIONE SX
-  Base  
SE INIZIO COMPOSIZIONE DX
-  Sopratop
-  Sottotop
-  Filotop
-  Flat
-  Appoggio
-  Profondità 1 vasca
-  Profondità 2 vasche
-  Vasca XL

**MISCELATORI**



-  Green
-  Inox AISI 304
-  Cambio getto
-  Doccetta
-  Reclinabile
-  Funzionamento leva 90°
-  Rotazione 360°
-  Full colour

**FORNI**

-  Classe energetica
-  Vano cottura XL
-  Defrost con illuminazione
-  Fan Defrost
-  Resistenza superiore e inferiore ventilata
-  Resistenza circolare ventilata
-  Resistenza inferiore ventilata
-  Resistenza inferiore e resistenza circolare ventilata
-  Grill doppia resistenza superiore ventilata
-  Grill
-  Doppio grill
-  Resistenza inferiore e superiore
-  Resistenza inferiore
-  Resistenza superiore
-  Steam clean
-  Cottura pizza
-  Funzione riscaldamento
-  Cottura patate
-  Cottura carne
-  Cottura pesce
-  Cottura verdura
-  Riscaldamento bevande

-  Cottura pasta
-  Preparazione popcorn
-  Cottura pollo

**DISSIPATORI**

-  Go green
-  Sistema antiiodori
-  Sistema di sicurezza

REALIZZATO DA ELLECI S.P.A.

in collaborazione con

ARCHÈ AGENCY S.R.L.

TIPOGRAFIA LUCE

Stampa

Stampato su carta certificata FSC.

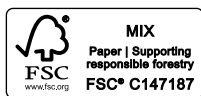

IL CATALOGO È PROPRIETÀ DI ELLECI S.P.A. TUTTI I DIRITTI SONO RISERVATI.

Sono tassativamente vietate le riproduzioni del presente catalogo, anche parziali, per fini commerciali senza specifica autorizzazione da parte di Elleci.

---

Elleci S.p.A. declina ogni responsabilità per possibili errori o inesattezze contenute nel catalogo, oltre a precisare che le immagini inserite e i dati forniti sono puramente indicativi.

LA STAMPA TIPOGRAFICA NON SEMPRE RIPRODUCE FEDELMENTE LE TINTE ED I MATERIALI ORIGINALI.

La riproduzione dei colori è PERTANTO da ritenersi puramente indicativa.

ELLECI S.P.A. SI RISERVA DI APPORTARE IN QUALSIASI MOMENTO E SENZA PREAVVISO MODIFICHE RITENUTE UTILI AL MIGLIORAMENTO DEI PROPRI PRODOTTI PRESENTI SU QUESTO CATALOGO.

I prezzi riportati nel presente Catalogo Listino sono al netto di IVA, trasporto ed eventuale ECO-Contributo RAEE.

---

Per l'installazione, l'utilizzo e la manutenzione dei prodotti acquistati, attenersi scrupolosamente a quanto riportato nel libretto di istruzione e manutenzione contenuto nella confezione. Non seguire scrupolosamente quanto indicato nei manuali di uso e manutenzione potrebbe comportare un decadimento delle prestazioni del prodotto e la esclusione della garanzia.

I prodotti contenuti all'interno di questo catalogo sono realizzati con la finalità di ottenere una fedeltà cromatica attraverso tecnologie costruttive differenti, per questo motivo eventuali variazioni nelle tonalità dei prodotti sono da attribuire al diverso materiale di base e rientrano in un range di tolleranza.

---





**Every day choices make your life.**