

LC-POWER™

LC-M40-UWQHD-144

GAMING MONITOR



BEDIENUNGSANLEITUNG

INHALT

1. Sicherheitshinweise
2. Wartung
3. Verpackungsinhalt
4. Produktübersicht
5. Standfußinstallation
6. Wandmontage
7. Anschließen der Kabel
8. Leuchtanzeige
9. OSD-Menü
10. Technische Daten

1. Sicherheitshinweise

Setzen Sie den Monitor nicht einer feuchten Umgebung, Regen oder anderen Flüssigkeiten aus.

Öffnen Sie nicht das Monitorgehäuse! Stromschlaggefahr durch Hochspannung innerhalb des Monitors!

Betrieb:

- Halten Sie den Monitor von direkter Sonneneinstrahlung und anderen Wärmequellen (z.B. Heizungen) fern.
- Halten Sie jegliche Flüssigkeiten vom Monitor fern.
- Achten Sie darauf, dass nichts in die Belüftungsöffnungen fallen kann.
- Blockieren Sie nicht die Belüftungsöffnungen, um eine Überhitzung zu vermeiden.
- Schlagen Sie nicht gegen den Monitor und lassen Sie das Gerät nicht fallen.

2. Wartung

ACHTUNG: Ziehen Sie das Netzkabel aus der Steckdose, bevor Sie den Monitor reinigen.

- Zum Reinigen des Bildschirms benutzen Sie ein weiches Tuch, das Sie leicht (!) mit destilliertem Wasser angefeuchtet haben.
- Verwenden Sie am besten spezielle Reinigungstücher für Bildschirme.
- Benutzen Sie keinesfalls Benzin, Verdünnung, sehr saure oder alkalische Mittel, Scheuermittel oder Druckluft!
- Ungeeignete Reinigungsmittel können den Monitor beschädigen und unschöne Schlieren auf dem Bildschirm und dem Gehäuse hinterlassen.
- Ziehen Sie den Netzstecker, wenn Sie den Monitor längere Zeit nicht benutzen.
- Halten Sie den Monitor von sämtlichen Flüssigkeiten, Staub und Feuchtigkeit fern.
- Falls der Monitor mit Flüssigkeiten in Berührung gerät, wischen Sie ihn sofort mit einem Tuch trocken.
- Falls Flüssigkeiten in die Belüftungsöffnungen eindringen, ziehen Sie sofort den Netzstecker und benutzen Sie den Monitor nicht mehr. Bitte wenden Sie sich an einen professionellen Servicetechniker.

Rechtliche Hinweise:

HDMI[™]
HIGH-DEFINITION MULTIMEDIA INTERFACE

HDMI, das HDMI-Logo und „High-Definition Multimedia Interface“ sind Marken oder eingetragene Marken der HDMI Licensing Administrator LLC in den USA und anderen Ländern.

3. Verpackungsinhalt

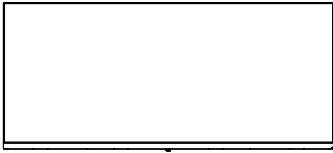

1 x Monitor

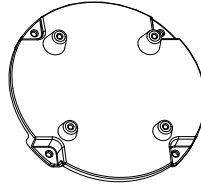

Wandmontierte
dekorative Abdeckung

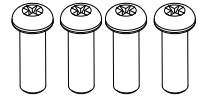

4 x PM5*15mm
Schraubenbolzen

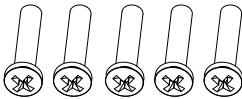

5 x M4*16mm Schraubenbolzen
(Wandmontage)

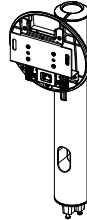

Ständerschaft x 1
(mit angebrachter Halterung)

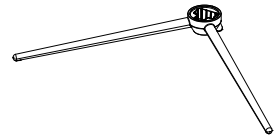

1 x Ständerbasis

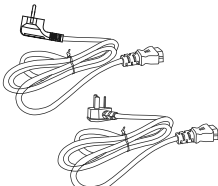

1 x Europäisches Netzkabel
1 x Britisches Netzkabel



1 x DP-Kabel

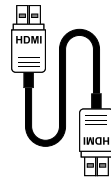

1 x HDMI-Kabel

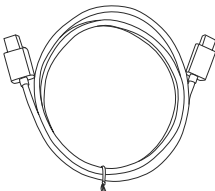

Type-C-Kabel



1 x Schraubendreher



Bedienungsanleitung



Eventuell sind zusätzliche Schrauben als Ersatz beigelegt.

4. Produktübersicht

4.1 — Tasten am Monitor

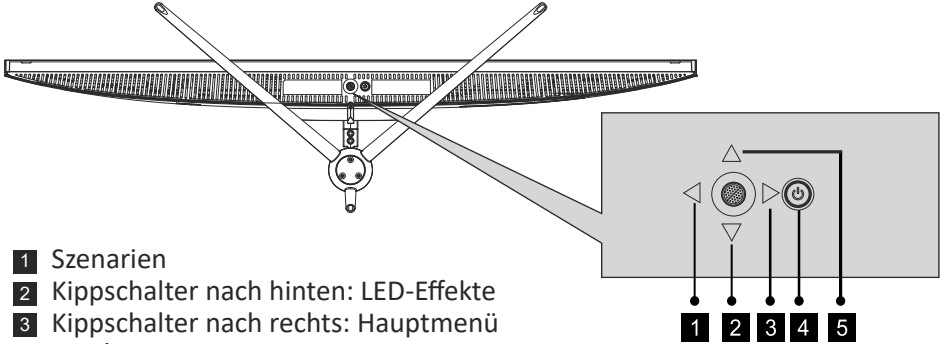

- 1 Szenarien
- 2 Kippschalter nach hinten: LED-Effekte
- 3 Kippschalter nach rechts: Hauptmenü
- 4 Ein-/Aus-Taste: Schaltet den Monitor ein und aus.
- 5 GamePlus

4.2 — Monitoranschlüsse

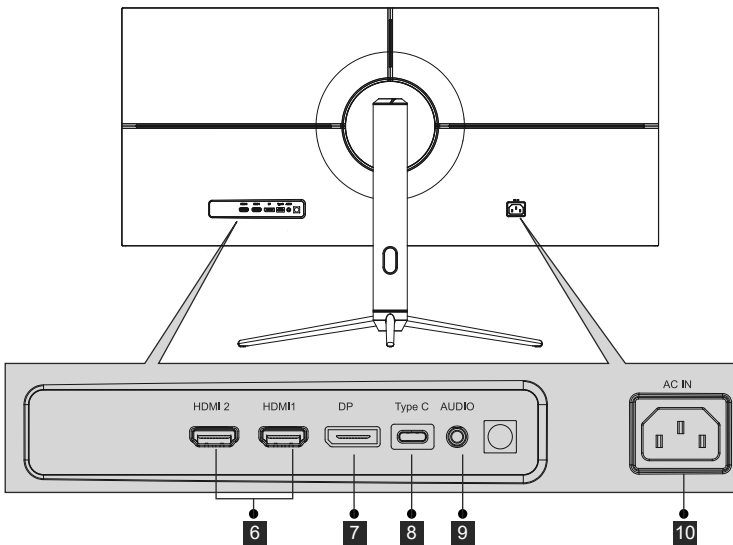

- 6 **HDMI-Eingänge:** Schließen Sie einen Stecker des HDMI-Kabels an den HDMI-Ausgang des Computers, den anderen Stecker an den HDMI-Port des Monitors an.
- 7 **DP-Anschluss:** Schließen Sie einen Stecker des DP-Kabels an den DP-Ausgang des Computers, den anderen Stecker an den DP-Port des Monitors an.
- 8 **Type-C:** Schließen Sie einen Stecker des Type-C-Kabels an den Type-C-Ausgang des Computers, den anderen Stecker an den Type-C-Port des Monitors an.
- 9 **Audioausgang:** Schließen Sie das Audiokabel zur Ausgabe von Audiosignalen an.
- 10 **Netzanschluss:** Hier schließen Sie das Netzkabel zur Stromversorgung des Monitors an.

5. Standfußinstallation

1. Öffnen Sie die Verpackung, nehmen Sie den Schaumstoff heraus und platzieren Sie es auf einem Tisch.

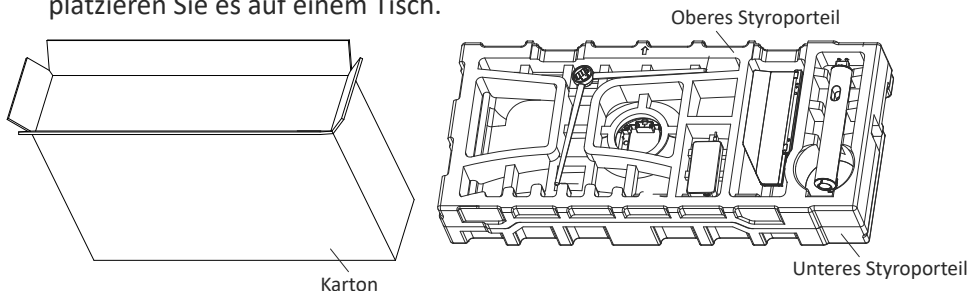

2. Nehmen Sie die obere Styroporabdeckung ab, entnehmen Sie den Rumpf aus dem Plastikbeutel und legen Sie ihn wieder in die Aussparung des unteren Styroporteils.

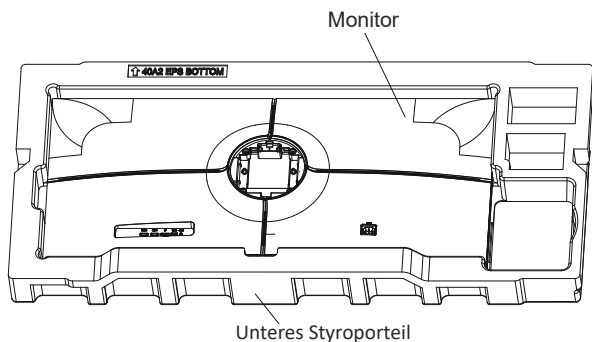

3. Nehmen Sie die Basis und die Halterung des Monitors heraus und befestigen Sie diese mit den drei PM5 x 15-mm-Schrauben (eine zusätzliche Ersatzschraube ist im Lieferumfang enthalten). Sie Abbildung unten.

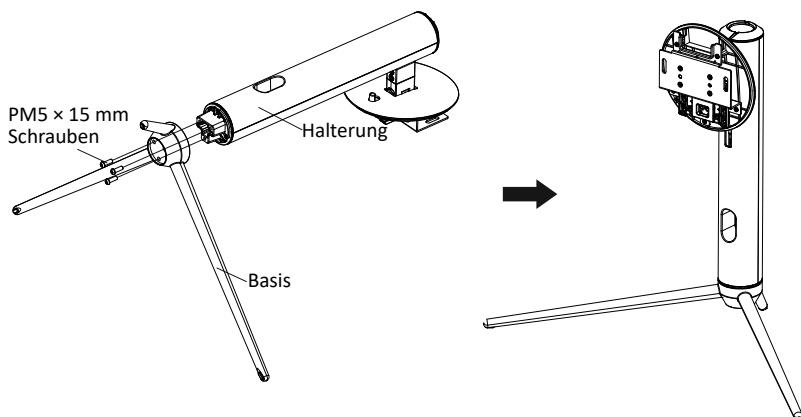

- Führen Sie die zusammengebaute Halterung schräg mit dem oberen Rand zuerst in die Öffnung der Rückseite des Monitorgehäuses ein. Drücken Sie die Halterung sanft nach unten bis diese einrastet.

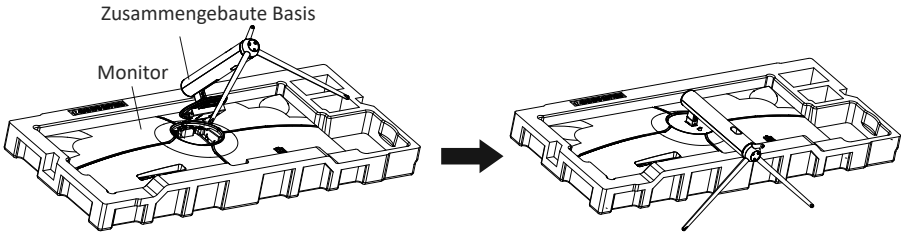

- Halten Sie den Trägerschaft mit der Hand und stellen Sie das Gerät auf.
Hinweis: Wenn Sie das Gerät aufrichten, dürfen Sie es nicht am Bildschirm festhalten und ihn nicht auf den Kopf drehen, um zu verhindern, dass das Gerät den Bildschirm beschädigt.

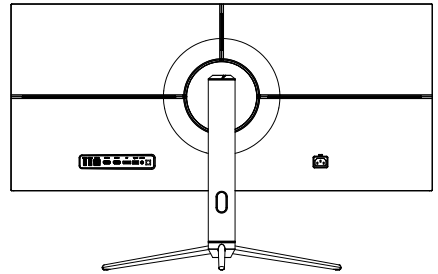
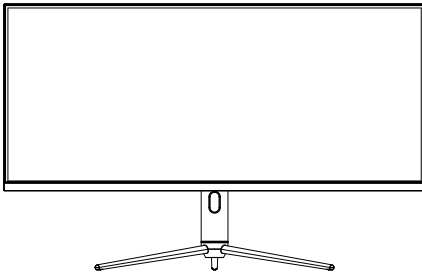

-  Legen Sie den Monitor auf eine flache Unterlage, bevor Sie den Ständer abnehmen.

6. Wandmontage



Die mitgelieferten Schrauben eignen sich ausschließlich zum Fixieren des Monitors an einer VESA-Halterung mit 75 x 75 mm Schraubenabstand. VESA-Halterungen und Montagezubehör erhalten Sie separat im Fachhandel.

- Öffnen Sie die Verpackung, nehmen Sie den Schaumstoff heraus und platzieren Sie es auf einem Tisch.

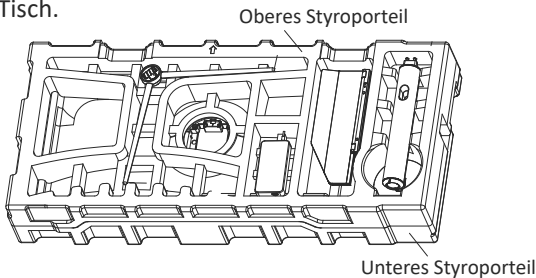

2. Nehmen Sie die obere Styroporabdeckung ab, entnehmen Sie den Rumpf aus dem Plastikbeutel und legen Sie ihn wieder in die Aussparung des unteren Styroporteils.

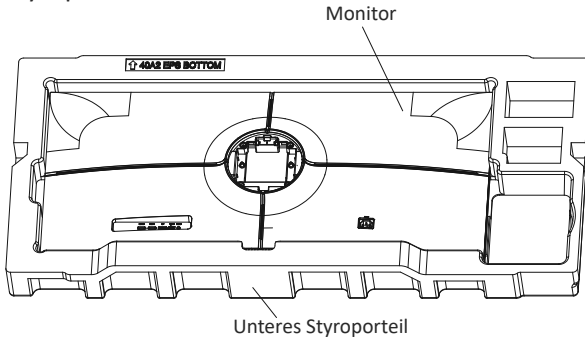

3. Entfernen Sie die hängende Zierabdeckung von der Innenseite des Aufsatzes. Nehmen Sie den Wandadapter und befestigen Sie diesen mit den vier Schrauben (PM4 x 16 mm) an der Rückseite des Monitorgehäuses.



Wandadapter



Fünf PM4 x 16 Schrauben, einschließlich einem Ersatzteil

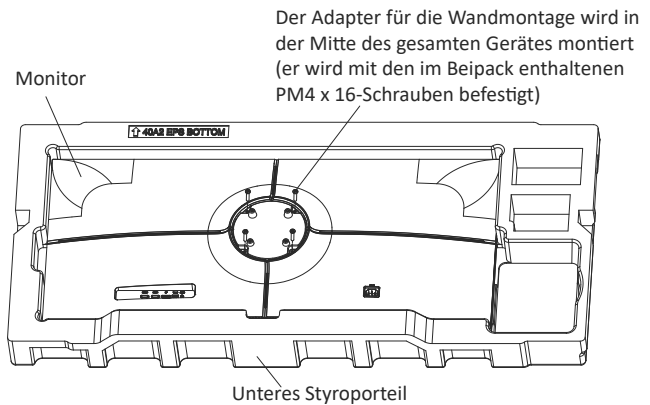

4. Berühren Sie den Bildschirm während der Bedienung der Wandhalterung nicht direkt mit den Händen.

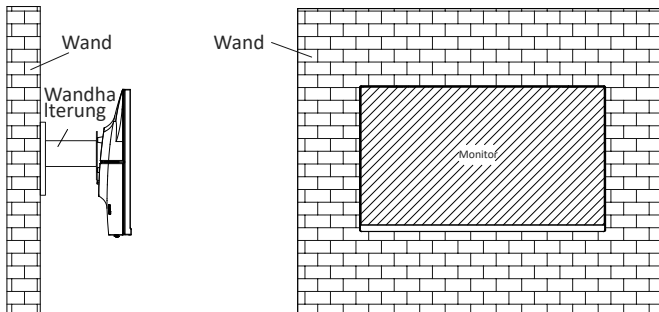

7. Anschließen der Kabel

1. Schließen Sie das DP-Kabel an den DP-Ausgang der PC-Grafikkarte an. Alternativ können Sie auch ein HDMI-Kabel verwenden. Ein HDMI-Kabel ist enthalten.
2. Verbinden Sie das andere Ende des DP-Kabels mit dem entsprechenden Anschluss am Monitor. Siehe Abbildung unten.

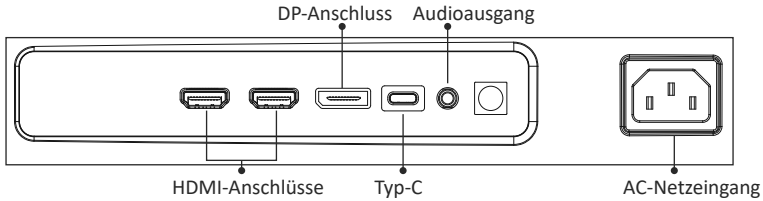

3. Verbinden Sie das Netzkabel mit Ihrem Monitor und einer Steckdose. Sollten Sie eine Steckdose nicht direkt nutzen können und eine Mehrfachsteckdose verwenden, sollte diese einen Überspannungsschutz mit ausreichender Kapazität bieten.
4. Zum Einschalten drücken Sie die Netztaaste am Monitor.

8. Leuchtanzeige

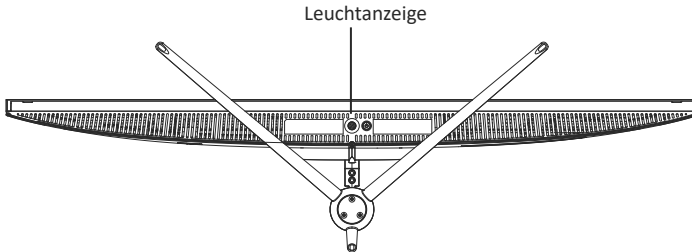

Leuchtanzeige

Blaues Leuchten bedeutet, dass der Monitor mit Strom versorgt wird und normal arbeitet. Blinkt das Licht rot, bedeutet das, dass keine Videoquelle vorhanden ist, kein horizontales oder vertikales Signal erkannt wurde oder die Stromversorgung schwach ist. Vergewissern Sie sich, dass Ihr Computer eingeschaltet ist und alle Videokabel vollständig eingesteckt und/oder angeschlossen sind.

9. OSD-Menü

Mit dem OSD-Menü (On-Screen Display) können Sie die Monitoreinstellungen anpassen. Das OSD-Menü erscheint, wenn Sie bei eingeschaltetem Monitor die M-Taste drücken.

 Wenn Sie den Monitor zum ersten Mal benutzen, passen sich die Einstellungen automatisch der Konfiguration Ihres Computers an.

OSD-Menü

1. Drücken Sie eine der Tasten (↵, ▼, ▲, ○, ⏻), um das Navigationsfenster zu öffnen.

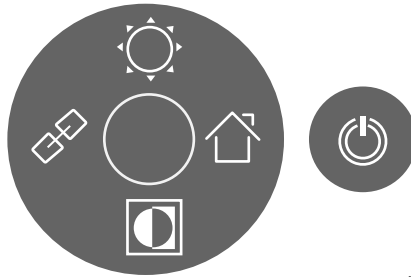

2. Drücken Sie zum Aufrufen des OSD-Bildschirms (🏠).

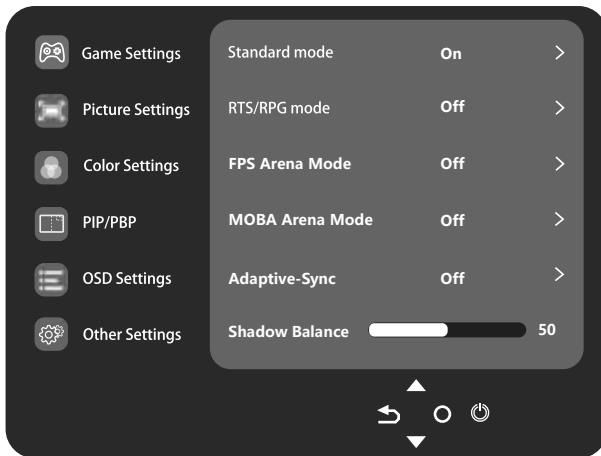

- 3. Drücken Sie ▼ oder ▲, um die Funktionen zu durchsuchen.
 - Wählen Sie die gewünschte Funktion und drücken Sie dann ○, um das Untermenü aufzurufen.
 - Drücken Sie ▼ oder ▲, um das Untermenü zu durchsuchen, und drücken Sie dann ○, um die Auswahl der gewünschten Funktion zu bestätigen.
 - Drücken Sie ▼ oder ▲, um eine Option auszuwählen. Anschließend drücken Sie ○, um die Einstellungen zu bestätigen und das aktuelle Menü zu verlassen.
- 4. Drücken Sie ↵, um die Menüoberfläche zu verlassen.

10. Technische Daten

| | |
|-----------------------------------|--|
| Modell | LC-M40-UWQHD-144 |
| Bildschirmgröße | 40" |
| Bildformat | 21:9 |
| Beleuchtung | E-LED |
| Helligkeit | 400 cd/m ² (typisch) |
| Panel | ADS (IPS) |
| Auflösung | DP1.4: 3440 × 1440 bei 144Hz HDMI 2.0: 3440 × 1440 bei 100Hz Type-C: 3440 × 1440 bei 60 Hz |
| Bildwiederholfrequenz | 144 Hz |
| Reaktionszeit | OD - 4 ms |
| Betrachtungswinkel | ≥ 178°(H) / ≥ 178°(V) |
| Kontrastverhältnis | 1200:1 |
| VESA-Montage | 75 x 75mm |
| Farben | 16,7 Mio. |
| Adaptive-Sync | Ja |
| Signaleingang | DP 1.4 x 1, HDMI 2.0 x 2, Typ C x 1 |
| Stromeingang | 100 – 240 Wechselspannung, 50/60 Hz, 3,0 A |
| Audio | |
| Lautsprecher | Nein |
| Audioausgang | Ja |
| Zubehör | |
| Netzkabel | Ja |
| HDMI-Kabel | Ja |
| DP-Kabel | Ja |
| Weitere Funktionen | |
| Niedrig. Blau | Ja |
| Abmessungen | |
| Abmessungen (mit Ständer) | 994,1*596,4*286,8mm |
| Abmessungen (ohne Ständer) | 994,1*418,3*82,4mm |
| Nettogewicht | 10,98kg |
| Bruttogewicht | 14,38kg |

TABLE OF CONTENTS

1. Safety Precautions
2. Maintenance
3. Box Contents
4. Product Overview
5. Stand Installation
6. Wall Mounting
7. Connectivity Options
8. Indicator Light
9. OSD
10. Technical Specifications

1. SAFETY PRECAUTIONS

Do not expose the monitor to a humid environment, rain or other liquids. Do not open the monitor housing to avoid any shock due to electrical or mechanical hazards.

Operation:

- Keep the monitor out of direct sunlight or other heat sources like stoves.
- Keep the monitor away from any liquid.
- Remove any object that could fall into the ventilation holes.
- Do not block the ventilation holes to avoid overheating.
- Do not knock or drop the monitor.

2.MAINTENANCE

CAUTION: Unplug the power cable from the outlet before cleaning the monitor.

- To clean your screen, slightly moisten a soft, clean cloth with water.
- Please use a special screen-cleaning tissue if possible.
- Do not use benzene, thinner, ammonia, abrasive cleaners or compressed air.
- Inappropriate cleaning solutions may damage the monitor or leave a milkyfilm on screen or housing.
- Unplug the monitor if you are not going to use it for a longer time period.
- Do not expose the monitor to dust, liquids or a humid environment.
- In case the monitor gets in touch with any liquid, wipe it down immediately using a dry cloth.
- In case any liquid gets spilled into the ventilation holes, do not use the monitor anymore. Please contact a professional service technician.

Legal notice:



The terms HDMI and HDMI High Definition Multimedia Interface, and the HDMI logo are trademarks or registered trademarks of HDMI Licensing Administrator, Inc. in the USA and other countries.

3.Box Contents

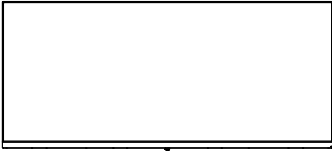

Monitor x1

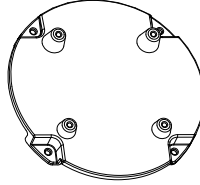

Wall mounted decorative cover

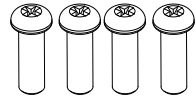

PM5*15mm Screw BoltsX4

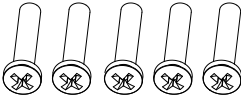

M4*16mm Screw Bolts X5
(Wall mounting)



Stand Stem x 1
(with Attached Bracket)

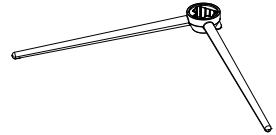

Stand Base x1

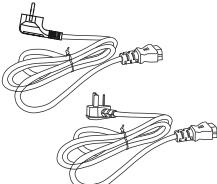

European Power Cable x 1
British Power Cable x 1



DP Cable x1

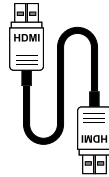

HDMI Cable x1

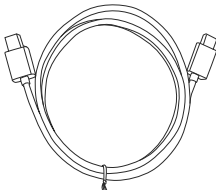

Type C Cable



Screwdriver x 1



User Manual



Extra screws may be included as backup.

4. Product Overview

4.1 —Monitor Buttons

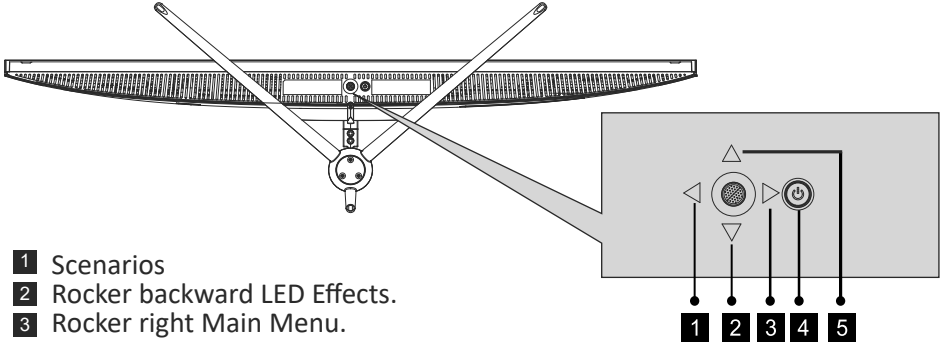

- 1 Scenarios
- 2 Rocker backward LED Effects.
- 3 Rocker right Main Menu.
- 4 Power Button: Press to turn the monitor on/off.
- 5 GamePlus

4.2—Monitor Ports

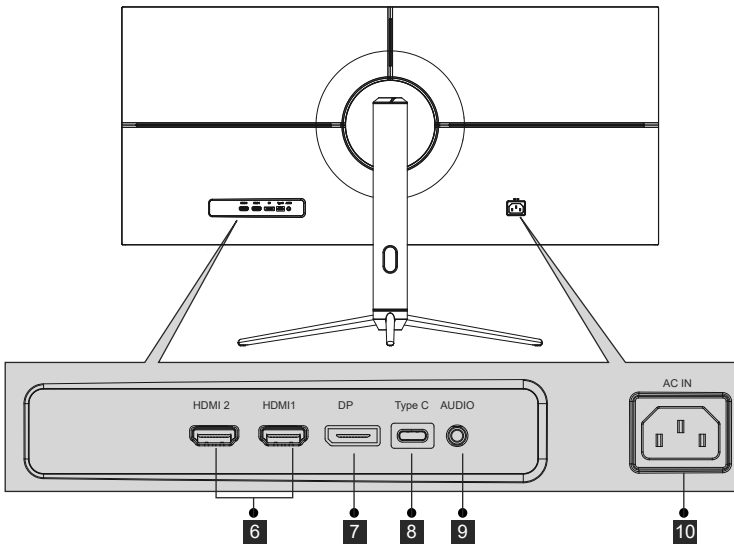

- 6 **HDMI Input:** Insert one end of the HDMI cable into the computer's HDMI output and connect the other end to the monitor's HDMI port.
- 7 **DP Connectors:** Insert one end of the DP cable into the computer's DP output and connect the other end to the monitor's DP port.
- 8 **Type-C:** Insert one end of the Type-c cable into the computer's Type-c output and connect the other end to the monitor's Type-c port.
- 9 **Audio Output:** Insert the audio cable for output of audio signals.
- 10 **Power Connector:** Insert the power cable to supply power to the monitor.

5. Stand Installation

1. Open the package, and then take out the foam and place it on a table.

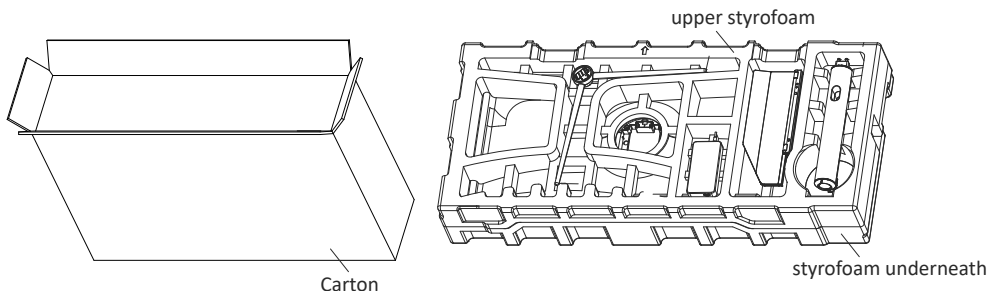

2. Take off the upper cover of styrofoam, take out the fuselage from the plastic bag, and place it in the lower cover cavity of poly dragon again.

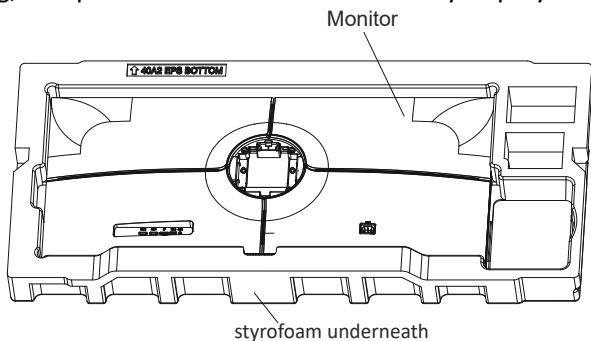

3. Take out the bracket and base, and lock them with three PM5*15mm countersunk screws (including one spare screw), as shown in the figure above.

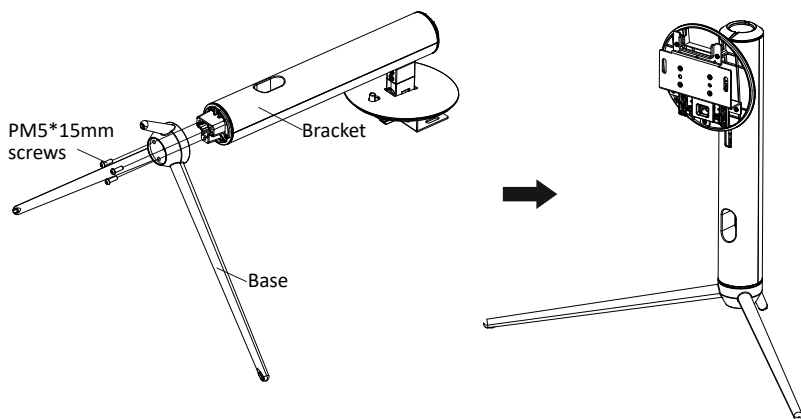

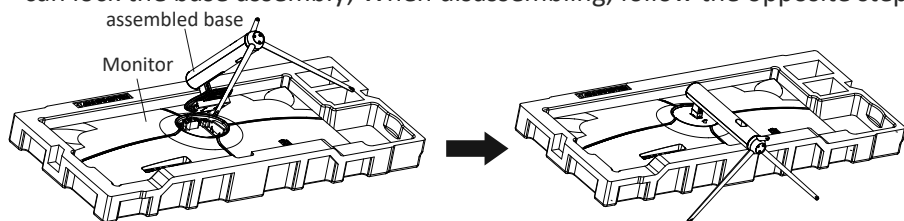

4. As shown in the figure above, put the base assembly assembled in step 3 into the corresponding sink of the rear shell, gently press the bracket to make the shaft assembly clip into the lock, then hold the middle position of the bracket, gently lift the fuselage twice without tripping, so as to ensure that the buckle can lock the base assembly; When disassembling, follow the opposite steps.

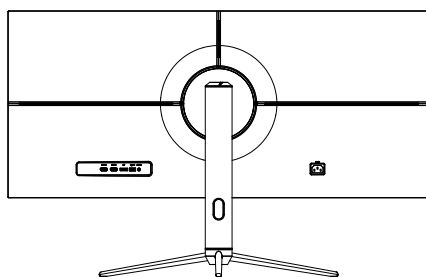
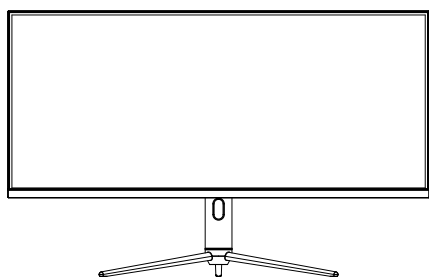

5. Hold the support shaft by hand and erect the machine.

Note: in the process of erecting the machine, please do not hold the screen or turn it upside down with your hands to prevent the machine from breaking the screen.



-  Make sure the monitor is laid on a flat surface before removing the stand.

6. Wall Mounting

 This monitor only includes screws which may be used when attaching the monitor to a VESA 75*75mm type mount. No VESA mount or mounting accessory is included.

1. Open the package, and then take out the foam and place it on a table.

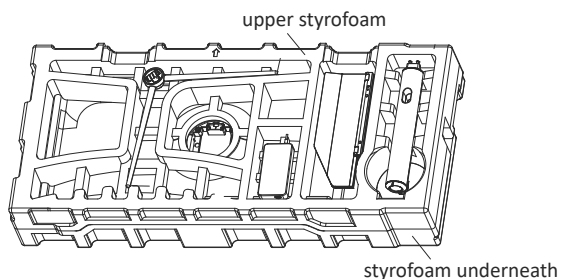

2. Take off the upper cover of poly dragon, take out the fuselage from the plastic bag, and place it in the lower cover cavity of poly dragon again.

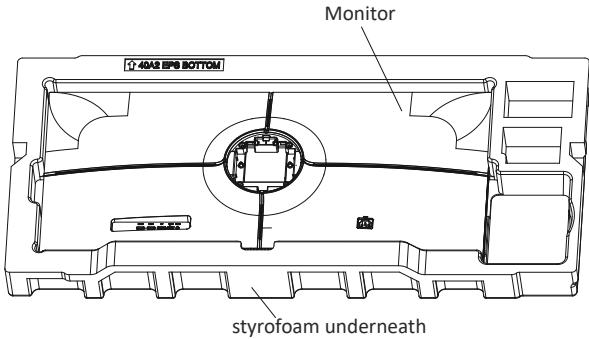

3. remove the hanging decorative cover from the inside of the attachment, lock the M4 thread hole in the middle of the shell with the 4 PM4*16 screws, and lock it with a screwdriver (for example, the green representative stud).

The wall mounted adapter is assembled in the middle of the whole machine (fixed with PM4*16 screws in the accessory package)

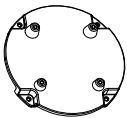

Wall mounted decorative cover



Five PM4*16 screws, including one spare part

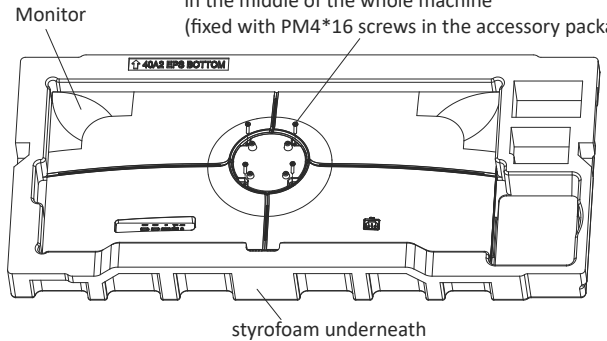

4. Do not touch the screen directly with hands during operating wall mount.

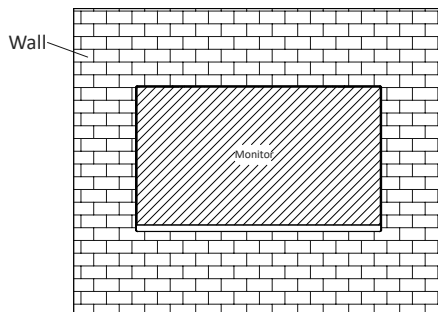
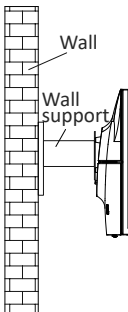

7. Connectivity Options

1. Insert one end of the DP cable into your PC's graphics card. An HDMI cable may also be used. HDMI cable is included.
2. Connect the other end of the cable to the corresponding connector on your monitor.

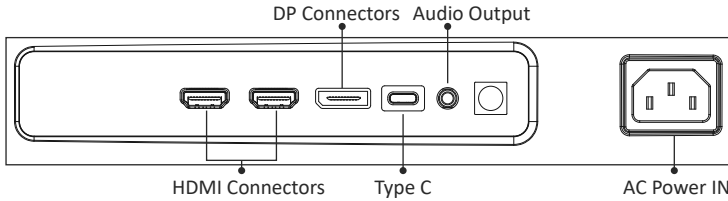

3. Connect the power cable to your monitor then connect the other end to your power source. It is recommended that you use a surge protector with adequate voltage if a wall outlet cannot be reached directly.
4. Locate the power button on the monitor and press it to turn the monitor on.

8. Light Indicator

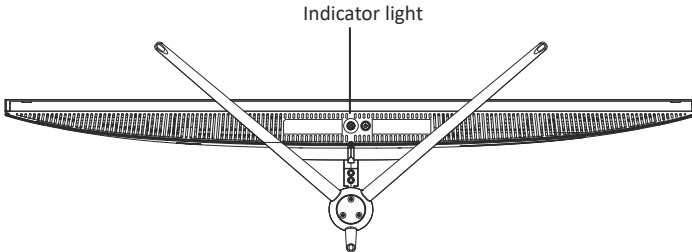

Indicator Light

Solid blue light indicates power is on and the monitor is operating normally. Flashing red light indicates no video source, no horizontal or vertical signal has been detected or power is low. Please ensure your computer is on and all video cables are fully inserted and/or connected.

9. OSD

The On-Screen Display (OSD) Menu may be used to adjust your monitor's settings and appears on screen after turning on the monitor and pressing the M button.

 When using the monitor for the first time, settings will automatically adjust to optimal settings according to your computer's configuration and parts etc.

OSD Menu

1. Press any one of the buttons (↶, ▼, ▲, ○, ⏻) to activate the navigation window.

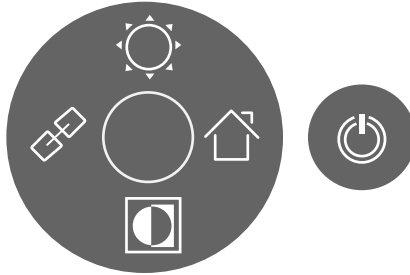

2. Press() to enter the OSD screen.

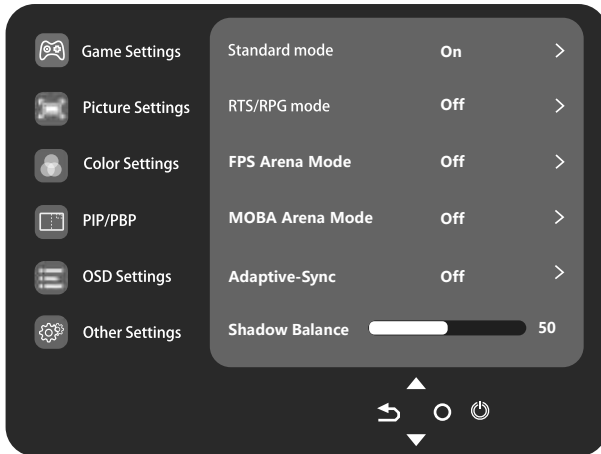

3. Press ▼ or ▲ browse function.

-Select the desired function and press ○ to enter the submenu.

-Press ▼ or ▲ to browse the submenu, and then press ○ to confirm the selection of the desired function.

-Press ▼ or ▲ to select an option, then press ○ to confirm the settings and exit the current menu.

4. Press ↶ to exit the menu interface

10. Technical Specifications

| | |
|-------------------------------|--|
| Model | LC-M40-UWQHD-144 |
| Screen Size | 40" |
| Aspect Ratio | 21:9 |
| Backlight | E-LED |
| Brightness | 400 cd/m ² (typ.) |
| Panel | ADS(IPS) |
| Resolution | DP1.4: 3440*1440@144Hz HDMI 2.0: 3440*1440@100Hz Type-C:3440*1440@60Hz |
| Refresh Rate | 144Hz |
| Response Time | OD 4ms |
| Viewing Angle | ≥ 178°(H) / ≥ 178°(V) |
| Contrast Ratio | 1200:1 |
| VESA Mounting | 75 x 75mm |
| Colours | 16.7M |
| Adaptive-Sync | Yes |
| Signal Input | DP 1.4*1, HDMI 2.0*2, Type C*1 |
| Power Input | AC 100-240V~ 50/60Hz, 3.0A |
| Audio | |
| Speakers | No |
| Audio Out | Yes |
| Accessories | |
| Power Cable | Yes |
| HDMI Cable | Yes |
| DP Cable | Yes |
| Additional Functions | |
| Low Blue Light | Yes |
| Physical Dimensions | |
| Dimensions (w/ Stand) | 994.1*596.4*286.8mm |
| Dimensions (w/o Stand) | 994.1*418.3*82.4mm |
| Net Weight | 10.98kg |
| Gross Weight | 14.38kg |

TABLE DES MATIÈRES

1. Précautions relatives à la sécurité
2. Maintenance
3. Contenu de la boîte
4. Description du produit
5. Installation du socle
6. Montage mural
7. Les options de connectivité
8. Témoin lumineux
9. OSD
10. Spécifications techniques

1. Précautions relatives à la sécurité

N'exposez pas le moniteur à un environnement humide, à la pluie ou à d'autres liquides.

Afin d'éviter tout choc dû à des risques électriques ou mécaniques, n'ouvrez pas le boîtier du moniteur.

Fonctionnement :

- Maintenez le moniteur à l'abri de la lumière directe du soleil ou d'autres sources de chaleur comme les convecteurs.
- Maintenez le moniteur éloigné de tout liquide.
- Retirez tout objet qui pourrait tomber dans les orifices de ventilation.
- Afin d'éviter toute surchauffe, n'obstruez pas les orifices de ventilation.
- Ne heurtez pas et ne laissez pas tomber le moniteur.

2. Maintenance

ATTENTION : Débranchez le cordon d'alimentation de la prise murale avant de nettoyer le moniteur,

- Pour nettoyer votre écran anti-statique, humidifiez légèrement un chiffon doux et propre avec de l'eau.
- Si possible, veuillez utiliser un chiffon spécial de nettoyage d'écran.
- N'utilisez pas de diluant, de benzène, d'ammoniac, de nettoyeur abrasif ni d'air comprimé.
- Les solutions de nettoyage inappropriées peuvent endommager le moniteur ou laisser un film blanchâtre sur l'écran ou sur le boîtier.
- Débranchez le moniteur si vous ne prévoyez pas de l'utiliser pendant une période prolongée.
- N'exposez pas le moniteur à la poussière, aux liquides ou à un environnement humide.
- Si le moniteur entre en contact avec un liquide, essuyez-le immédiatement avec un chiffon sec.
- Si du liquide rejaillit sur les ouvertures de ventilation, cessez d'utiliser le moniteur. Veuillez contacter un technicien professionnel.

Rappel légal :

HDMI[™]
HIGH-DEFINITION MULTIMEDIA INTERFACE

Les termes Interface Multimédia Haute Définition HDM1 et HDMI1, et le logo HDM1 sont des marques déposées par l'administrateur de licence d'HMD1, Inc. aux États-Unis et dans d'autres pays.

3. Contenu de la boîte

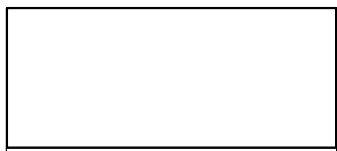

Moniteur x1

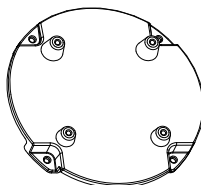

Couvercle
décoratif mural

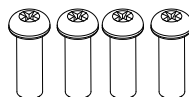

Boulon fileté PM5*15mm x 4

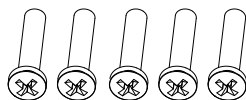

Boulon fileté M4* 16mm x 5
(montage mural)

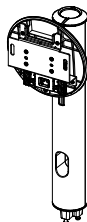

Tige de support x 1
(avec support attaché)

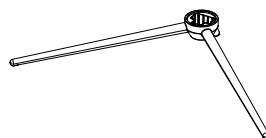

Support Base x 1

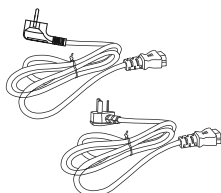

Câble d'alimentation européen x 1
Câble d'alimentation britannique x 1

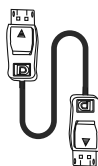

Câble DP x1

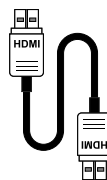

Câble HDMI x1

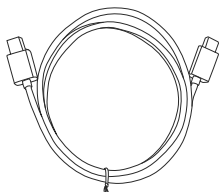

Câble Type-C



Tournevis x 1

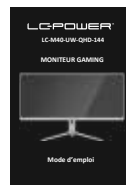

Mode d'emploi



Des vis supplémentaires peuvent être fournies servant de vis de secours.

4. Description du produit

4.1 — Boutons du moniteur

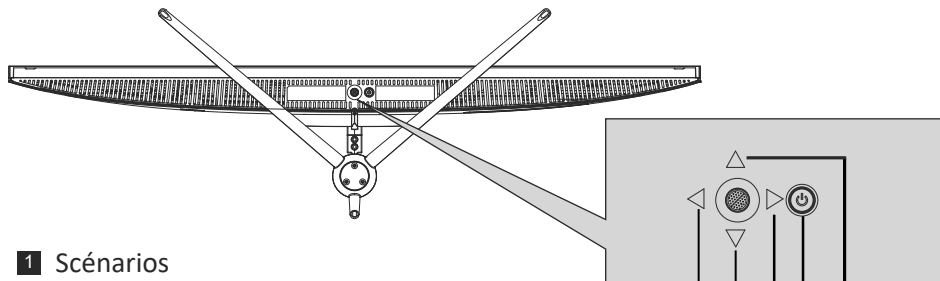

- 1 Scénarios
- 2 Bascule vers l'arrière : Effets DEL.
- 3 Bascule vers la droite : Menu principal.
- 4 Bouton d'alimentation : Appuyez pour allumer ou éteindre le moniteur.
- 5 GamePlus

4.2 — Ports du moniteur

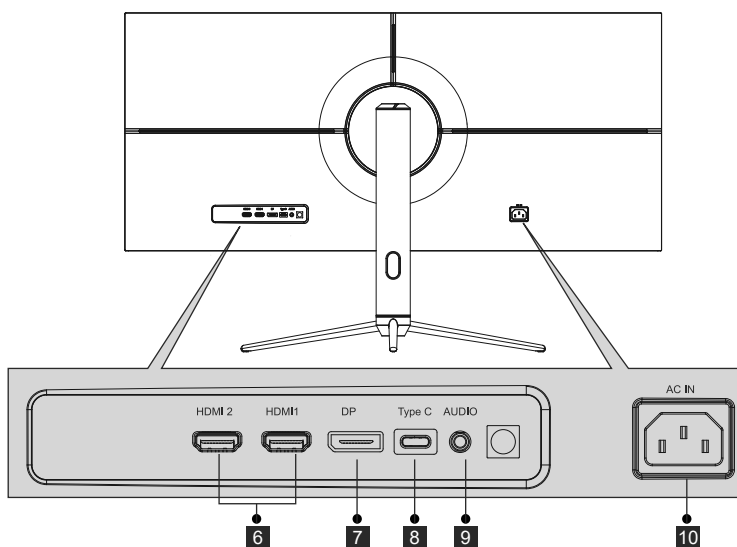

- 6 **Entrée HDMI** : Insérez une extrémité du câble HDMI dans la sortie HDMI de l'ordinateur puis branchez l'autre extrémité du câble dans le port HDMI du moniteur.
- 7 **Connecteurs DP** : Insérez une extrémité du câble DP dans la sortie DP de l'ordinateur puis branchez l'autre extrémité du câble dans le port DP du moniteur.
- 8 **Type-C** : Insérer une extrémité du câble Type-C dans la sortie Type-C de l'ordinateur puis branchez l'autre extrémité du câble dans le port Type-C du moniteur.
- 9 **Sortie audio** : Insérez le câble audio pour obtenir des signaux audio de sortie.
- 10 **Connecteur d'alimentation** : Insérez le câble d'alimentation pour alimenter le moniteur.

5. Installation du socle

1. Défaites l'emballage, sortez la mousse et placez le produit sur une table horizontale.

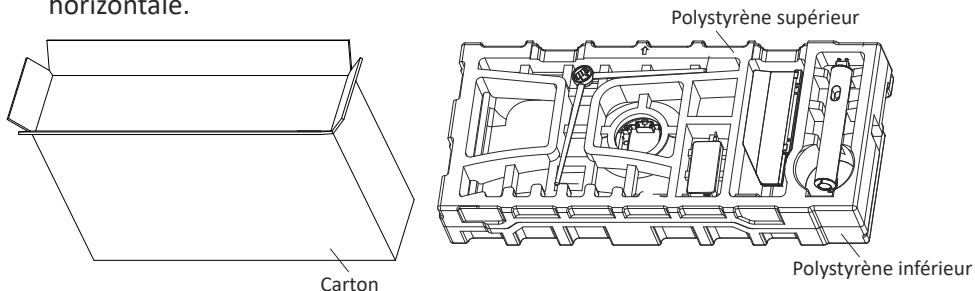

2. Retirez le couvercle supérieur de polystyrène, sortez le fuselage du sac plastique et replacez-le dans la cavité du couvercle inférieur du polystyrène.

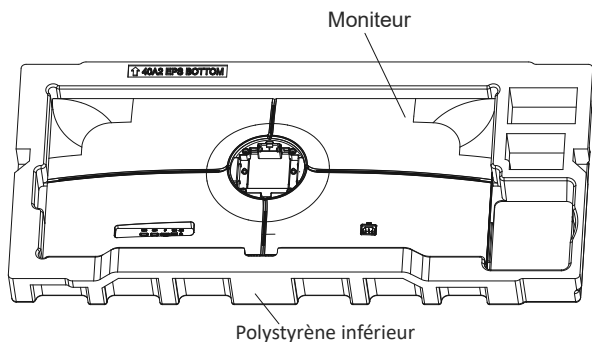

3. Sortez le support et le socle et attachez-les ensemble à l'aide de 3 vis à tête fraisée PM5*15mm (y compris une vis de rechange), comme indiqué sur la figure ci-dessus.

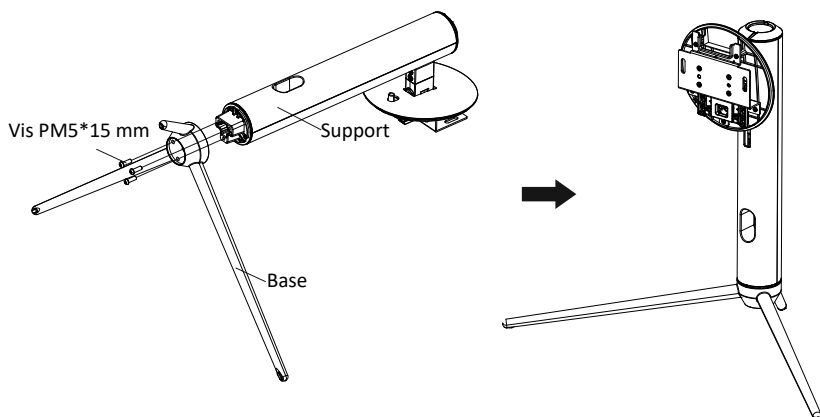

- Comme indiqué sur la figure ci-dessous, mettez l'assemblage du socle monté à l'étape 3 dans la fente correspondante située dans la coque arrière, appuyez doucement sur le support pour que l'assemblage de l'arbre clipse dans le verrou, puis tenez la position intermédiaire du support, soulevez doucement le fuselage à deux reprises sans le faire bouger, de façon à garantir que la boucle puisse se fixer à l'assemblage du socle. Procédez dans l'ordre inverse pour le désassemblage.

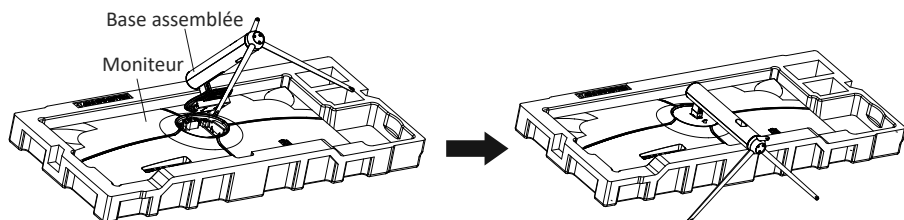

- Dressez la machine en tenant l'arbre du support à la main.
Remarque : durant le processus de mise en place de la machine, veuillez ne pas tenir ou retourner l'écran à la main, ceci afin d'éviter de le fendre.

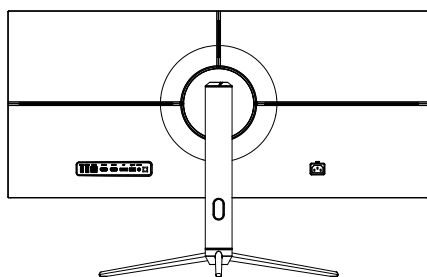
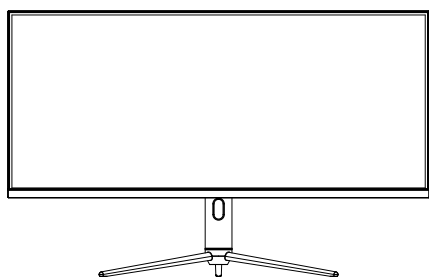

-  Assurez-vous que le moniteur est posé sur une surface plane avant de retirer le socle.

6. Montage mural



Ce moniteur comprend uniquement les vis qui peuvent être nécessaires lors de la fixation de celui-ci à un support de type VESA 75*75 mm. Aucun support ou accessoire de fixation VESA n'est inclus.

- Défaites l'emballage, sortez la mousse et placez le produit sur une table horizontale.

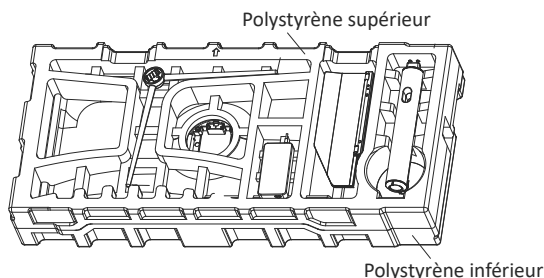

- Retirez le couvercle supérieur de polystyrène, sortez le fuselage du sac plastique et placez-le dans la cavité du couvercle inférieur du polystyrène.

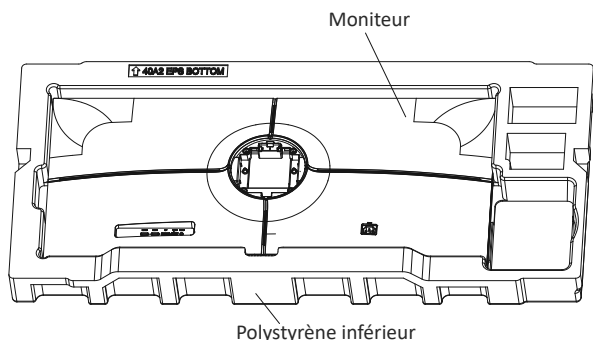

- Retirez le couvercle décoratif de suspension de l'intérieur de l'accessoire, verrouillez le trou fileté M4 au milieu de la coque à l'aide de 4 vis 4 PM4*16, puis fixez-le à l'aide d'un tournevis (par exemple, le tournevis vert).

L'adaptateur de fixation murale est assemblé au milieu de la machine. (Il est fixé à l'aide de vis PM4*16 qui se trouve dans le sac d'accessoire).

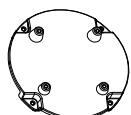

Couvercle décoratif mural



Cinq vis PM4*16, Y compris une pièce de rechange

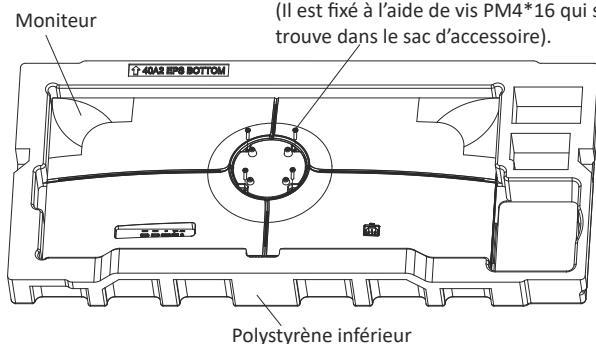

- Ne touchez pas l'écran directement avec les mains pendant que vous procédez à l'installation murale.

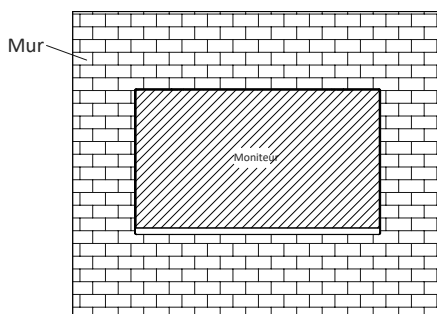
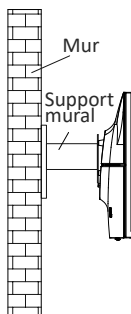

7. Les options de connectivité

1. Insérez une extrémité du câble DP dans la carte graphique de votre PC. Vous pouvez également utiliser un câble HDMI. Le câble HDMI est inclus.
2. Branchez l'autre extrémité du câble sur le connecteur correspondant de votre moniteur.

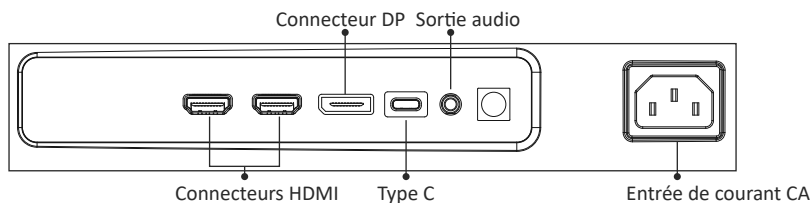

3. Connectez le câble d'alimentation à votre moniteur, puis connectez l'autre extrémité à votre source d'alimentation. Il est recommandé d'utiliser un parasurtenseur avec une tension adéquate si une prise murale ne peut pas être atteinte directement.
4. Localisez le bouton d'alimentation sur le moniteur et appuyez dessus pour allumer le moniteur.

8. Témoin lumineux

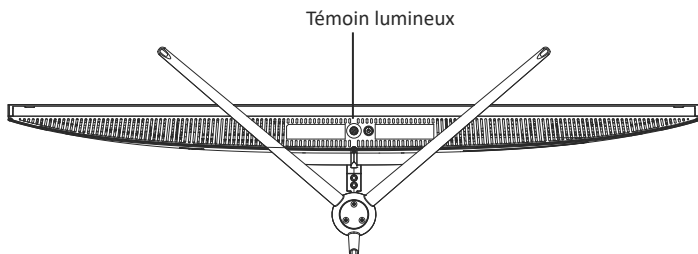

Témoin lumineux

Le voyant bleu fixe indique que l'appareil est sous tension et que le moniteur fonctionne normalement. Une lumière bleue clignotante indique qu'il n'y a pas de source vidéo, et qu'aucun signal horizontal ou vertical n'a été détecté ou bien que le courant est faible. Veuillez vous assurer que votre ordinateur est allumé et que tous les câbles vidéo sont correctement insérés et/ou branchés.

9. OSD

Le menu d'affichage à l'écran (OSD) peut être utilisé pour régler les paramètres de votre moniteur et apparaît à l'écran après avoir allumé le moniteur et appuyé sur le bouton M.

 Lorsque vous utilisez le moniteur pour la première fois, les paramètres se règlent automatiquement sur les valeurs optimales en fonction de la configuration et des composants de votre ordinateur, etc.

MENU OSD



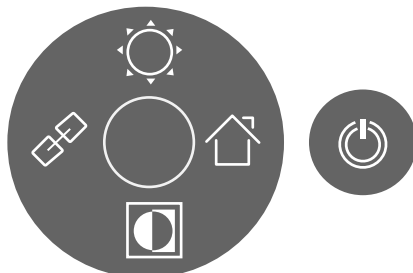

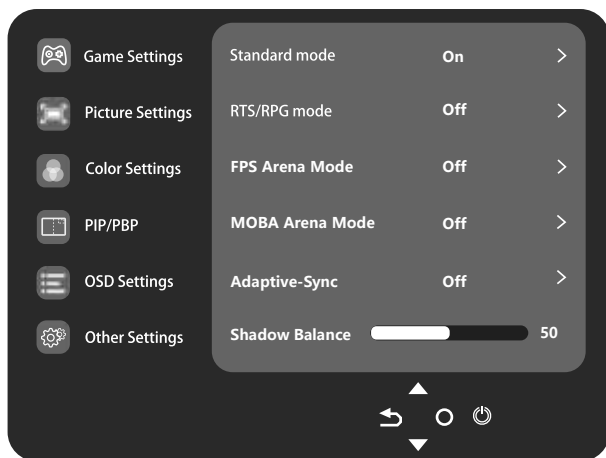

1. Appuyez sur l'un des boutons (, , , , ) pour activer la fenêtre de navigation.



2. Appuyez sur () pour entrer dans l'écran OSD.



3. Appuyez sur  ou  naviguez dans les fonctions.

- Sélectionner la fonction désirée puis appuyez sur  pour entrer dans le sous-menu.
- Appuyez sur  ou  pour naviguer dans le sous-menu, puis appuyez sur  pour confirmer la sélection de la fonction souhaitée.
- Appuyez sur  ou  pour sélectionner une option, puis appuyez sur  pour confirmer les paramètres et quitter le menu courant.

4. Appuyez sur  pour quitter l'interface de menu.

10. Spécifications Techniques

| | |
|----------------------------------|--|
| Modèle | LC-M40-UWQHD-144 |
| Taille d'écran | 40" |
| Format d'image | 21:9 |
| Rétroéclairage | E-LED |
| Luminosité | 400 cd/m ² (typique) |
| Panneau | ADS(IPS) |
| Résolution | DP1.4 : 3440 * 1440 à 144Hz HDMI 2.0 : 3440 * 1440 à 100Hz Type-C : 3440*1440@60Hz |
| Taux de rafraîchissement | 144Hz |
| Temps de réponse | OD 4ms |
| Angles de vue | ≥ 178° (H) / ≥ 178° (V) |
| Taux de contraste | 1200:1 |
| Montage VESA | 75 x 75mm |
| Couleurs | 16,7 M |
| Adaptive-Sync | Oui |
| Entrée de signal | DP 1.4*1, HDMI 2.0*2, Type C*1 |
| Entrée de courant : | CA 100-240V, 50/60Hz, 3,0A |
| Audio | |
| Haut-parleurs | Aucune |
| Sortie Audio | Oui |
| Accessoires | |
| Câble d'alimentation | Oui |
| Câble HDMI | Oui |
| Câble DP | Oui |
| Fonctions supplémentaires | |
| Faible lumière bleue | Oui |
| Dimensions physiques | |
| Dimensions (avec socle) | 994,1 * 596,4 * 286,8mm |
| Dimensions (sans socle) | 994,1 * 418,3 * 82,4mm |
| Poids net | 10,98kg |
| Poids brut | 14,38kg |

INDICE

1. Precauzioni sulla sicurezza
2. Maintenance
3. Contenuto della confezione
4. Descrizione del prodotto
5. Installazione del supporto
6. Montaggio a parete
7. Opzioni di connettività
8. Indicatore
9. OSD
10. Specifiche tecniche

1. Precauzioni sulla sicurezza

Non esporre il monitor a un ambiente umido, pioggia o altri liquidi.
Non aprire l'alloggiamento del monitor per evitare scosse dovute a rischi elettrici o meccanici.

Funzionamento:

- Tenere il monitor lontano dalla luce solare diretta o da altre fonti di calore come stufe.
- Tenere il monitor lontano da qualsiasi liquido.
- Rimuovere eventuali oggetti che potrebbero cadere nei fori di ventilazione.
- Non ostruire i fori di ventilazione per evitare il surriscaldamento.
- Non far subir urti né far cadere il monitor.

2. Maintenance

ATTENZIONE: Scollegare il cavo di alimentazione dalla presa prima di pulire il monitor.

- Per pulire lo schermo, inumidire leggermente un panno morbido e pulito.
- Utilizzare uno speciale panno per la pulizia dello schermo, se possibile.
- Non utilizzare benzene, solventi, ammoniaca, detergenti abrasivi o aria compressa.
- Le soluzioni di pulizia inadeguate potrebbero danneggiare il monitor o lasciare una pellicola lattiginosa sullo schermo o sull'alloggiamento.
- Scollegare il monitor se non lo si utilizza per un periodo di tempo più lungo.
- Non esporre il monitor a polvere, liquidi o ambienti umidi.
- Se il monitor viene a contatto con qualsiasi liquido, pulirlo immediatamente con un panno asciutto.
- In caso di versamento di liquido nei fori di ventilazione, non utilizzare più il monitor. Contattare un tecnico di assistenza professionale.

Avviso legale:

HDMI™
HIGH-DEFINITION MULTIMEDIA INTERFACE

I termini HDMI, HDMI High-Definition Multimedia Interface e il logo HDMI sono marchi di fabbrica o marchi registrati di HDMI Licensing Administrator, Inc. negli Stati Uniti e in altri Paesi.

3. Contenuto della confezione

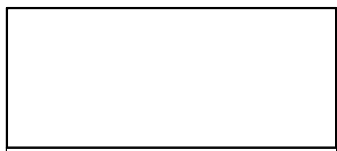

Monitor x 1

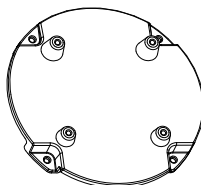

Copertura decorativa a muro

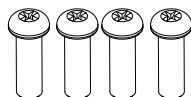

Bulloni PM5*15mm x 4

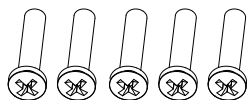

Bulloni M4*16mm x 5
(Montatura a muro)

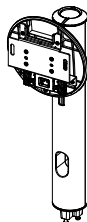

Attacco supporto x 1
(con staffa fissata)

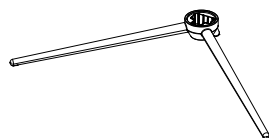

Base supporto x 1

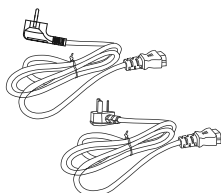

Cavo di alimentazione europeo x 1
Cavo di alimentazione britannico x 1

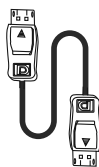

Cavo DP x 1

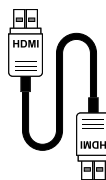

Cavo HDMI x 1

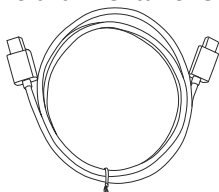

Cavo tipo C



Cacciavite x 1



MANUALE UTENTE



Potrebbero essere incluse viti extra di ricambio.

4. Descrizione del prodotto

4.1 — Tasti del monitor

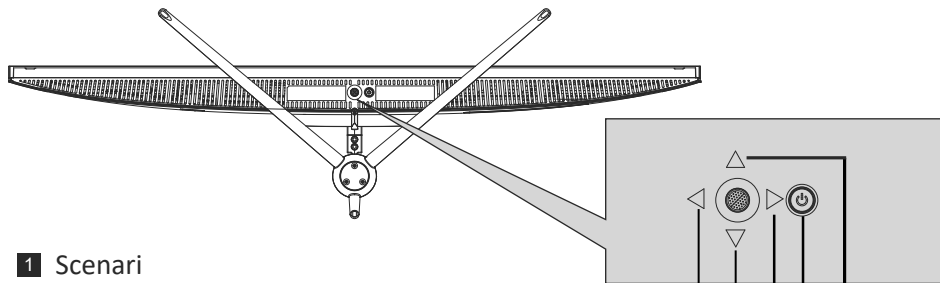

- 1 Scenari
- 2 Interruttore a leva indietro per effetti LED:
- 3 Interruttore a leva a destra per menu principale
- 4 Tasto alimentazione: Premere per accendere/spegnere il monitor.
- 5 GamePlus

4.2 — Porte del monitor

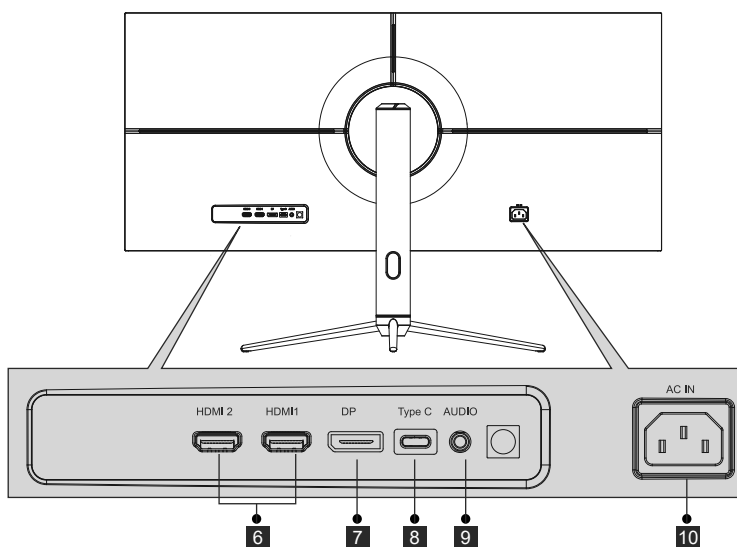

- 6 **Ingresso HDMI:** Inserire un'estremità del cavo HDMI nell'uscita HDMI del computer e collegare l'altra estremità alla porta HDMI del monitor.
- 7 **Connettori DP:** Inserire un'estremità del cavo DP nell'uscita DP del computer e collegare l'altra estremità alla porta DP del monitor.
- 8 **Tipo C:** Inserire un'estremità del cavo Tipo C nell'uscita Tipo C del computer e collegare l'altra estremità alla porta Tipo C del monitor.
- 9 **Uscita audio:** Inserire il cavo audio per l'uscita dei segnali audio.
- 10 **Connettore di alimentazione:** Inserire il cavo di alimentazione nell'alimentatore del monitor.

5. Installazione del supporto

1. Aprire il pacco, e in seguito togliere la gommapiuma e riporlo sul tavolo.

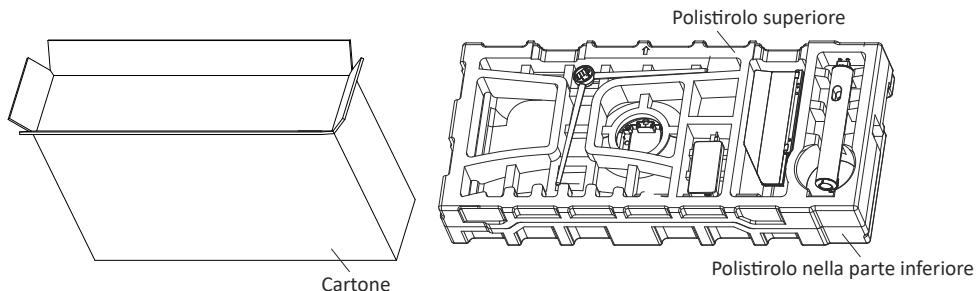

2. Rimuovere la copertura superiore di polistirolo, rimuovere la fusoliera dalla busta di plastica, e posizionarla nuovamente nella cavità coperta inferiore di polistirolo.

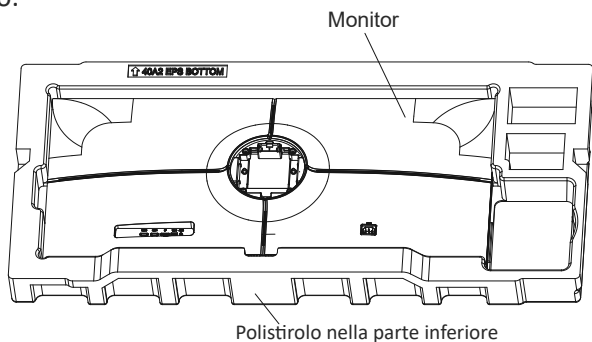

3. Rimuovere la staffa e la base, e posizionarle con tre viti svasate PM 5 x 15 mm (compresa una vite di ricambio), come mostrato nella figura precedente.

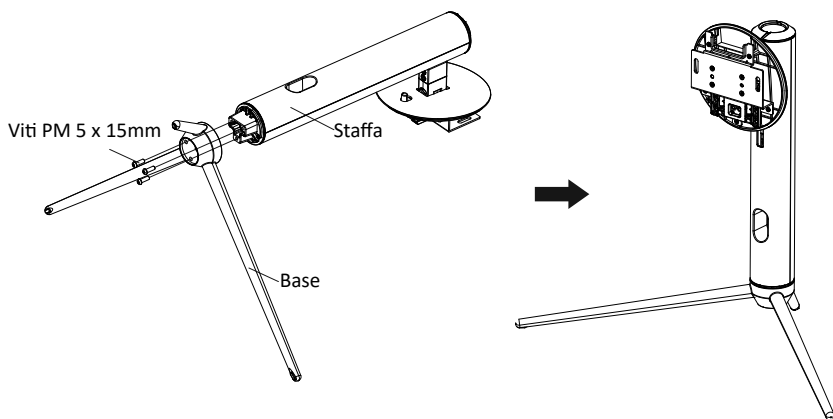

4. Come mostrato nella figura precedente, posizionare l'assemblaggio di base assemblato nel passaggio 3 nel corrispondente vano nella scocca posteriore, premere delicatamente la staffa per far sì che l'asse si agganci al blocco, in seguito tenere la posizione media della staffa, alzare con delicatezza la fusoliera due volte senza farla cadere, in modo da assicurarsi che la fibbia possa bloccare l'assemblaggio di base; durante il disassemblaggio, seguire i passaggi opposti.

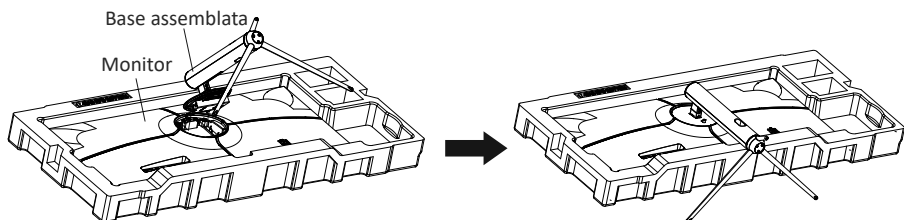

5. Tenere l'albero di supporto con la mano e raddrizzare la macchina.
Attenzione: durante il montaggio della macchina, non tenere lo schermo o girarlo a testa in giù con le mani al fine di impedire alla macchina di rompere lo schermo.

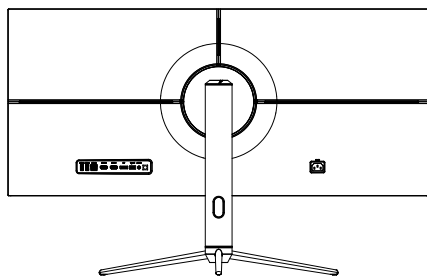
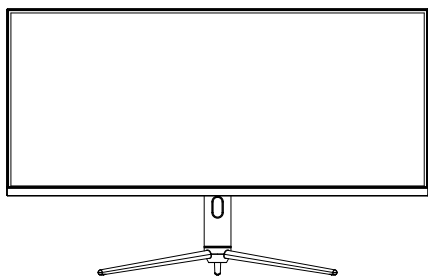

-  Assicurarsi che il monitor sia posizionato su una superficie piana prima di rimuovere il supporto.

6. Montaggio a parete



Questo monitor include solo viti che possono essere utilizzate quando si collega il monitor a un supporto di tipo VESA 75*75 mm. Non sono inclusi accessori per montaggio o supporto VESA.

1. Aprire il pacco, e in seguito togliere la gommapiuma e riporlo sul tavolo.

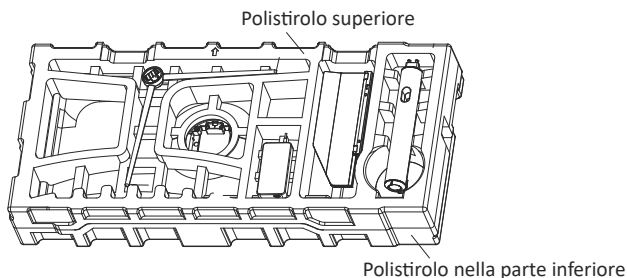

2. Rimuovere la copertura superiore di polistirolo , rimuovere la fusoliera dalla busta di plastica, e posizionarla nella cavità coperta inferiore di polistirolo .

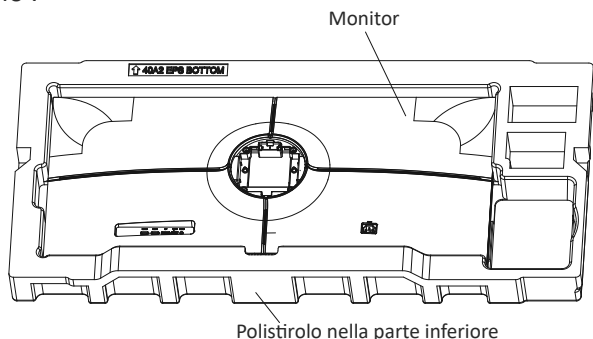

3. Rimuovere la copertura decorativa appesa dalla parte interna del fissaggio, bloccare il foro del cavo M4 al centro dell'involucro con le 4 viti PM 4 x 16, e bloccarlo con un cacciaviti (per esempio, il perno verde di rappresentanza).

L'adattatore montato a muro è assemblato nella parte centrale della macchina (Fissato con viti PM 4 x 166 nel pacco accessori)

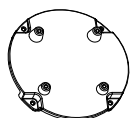

Copertura decorativa a muro



Cinque viti PM 4 x 16 compresa una di ricambio

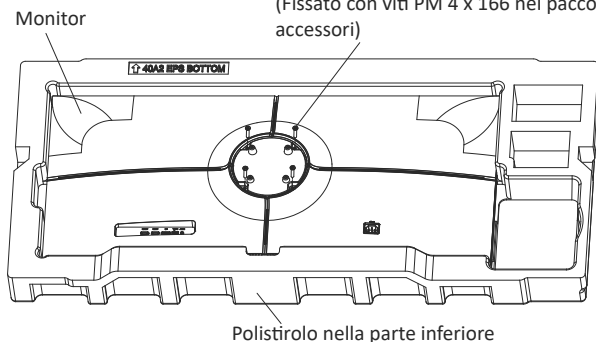

4. Non toccare lo schermo direttamente con le mani durante l'operazione della montatura al muro.

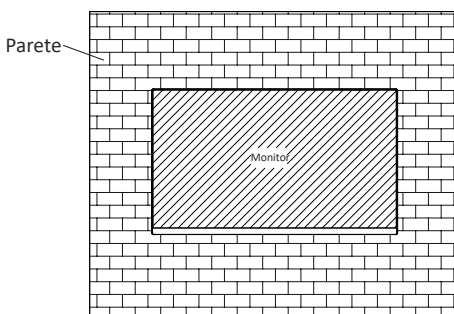
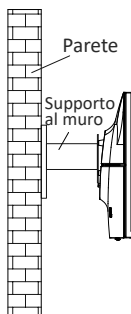

7. Opzioni di connettività

1. Inserire un'estremità del cavo DP nella scheda grafica del PC. È inoltre possibile utilizzare un cavo HDMI. Il cavo HDMI è incluso.
2. Collegare l'altra estremità del cavo al corrispondente connettore del monitor.

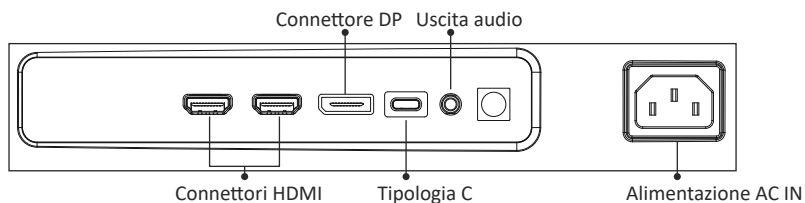

3. Collegare il cavo di alimentazione al monitor, quindi collegare l'altra estremità alla fonte di alimentazione. Si consiglia di utilizzare un limitatore di sovratensione con una tensione adeguata, se non è possibile raggiungere direttamente una presa a muro.
4. Individuare il tasto di accensione sul monitor e premerlo per accenderlo.

8. Indicatore

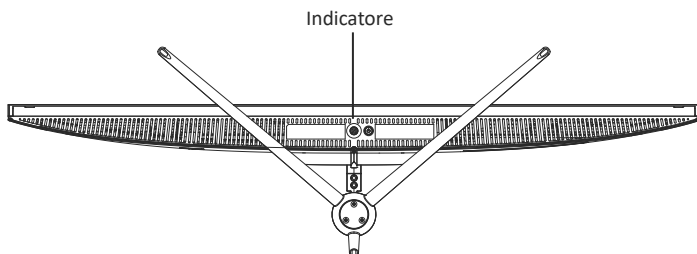

Indicatore





La spia blu fissa indica che l'alimentazione è accesa e il monitor funziona normalmente. La spia rossa lampeggiante indica nessuna sorgente video, nessun segnale orizzontale o verticale trovato oppure energia bassa. Assicurarsi che il computer sia acceso e che tutti i cavi video siano inseriti e/o connessi completamente.

9. OSD

Il menu OSD (On-Screen Display) può essere utilizzato per regolare le impostazioni del monitor e appare sullo schermo dopo aver acceso il monitor e premuto il tasto M.

 Quando si utilizza il monitor per la prima volta, le impostazioni si adattano automaticamente alle impostazioni ottimali in base alla configurazione e alle parti del computer, ecc.

Menu OSD



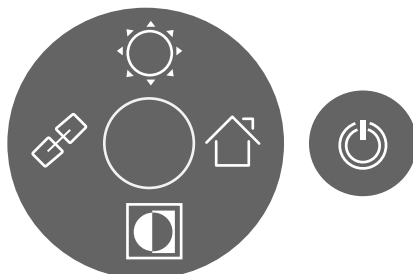

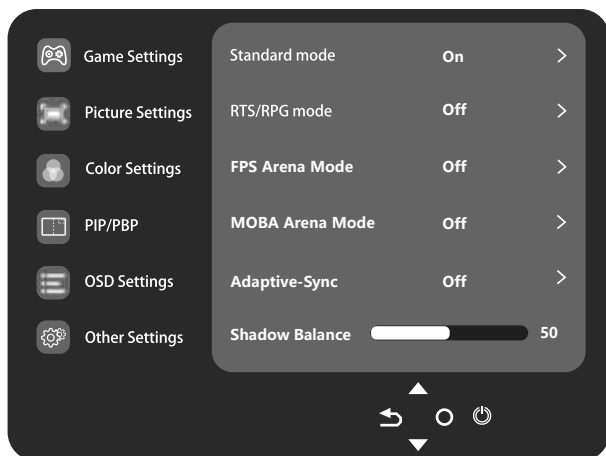

1. Premere un tasto (, , , , ) per attivare la finestra di navigazione.



2. Premere () per accedere alla schermata OSD.



3. Funzione premi  o  naviga.

- Selezionare la funzione desiderata e premere  per entrare nel submenu.
- Premere  o  per navigare nel submenu, e in seguito premere  per confermare la selezione della funzione desiderata.
- Premere  o  per selezionare un'opzione, e in seguito premere  per confermare le impostazioni e uscire dal menu corrente.

4. Premi  per uscire dall'interfaccia menu

10. Specifiche tecniche

| | |
|------------------------------------|--|
| Modello | LC-M40-UWQHD-144 |
| Dimensioni schermo | 40" |
| Proporzioni | 21:9 |
| Retroilluminazione | E-LED |
| Luminosità | 400 cd/m ² (tip.) |
| Pannello | ADS(IPS) |
| Risoluzione | DP1.4: 3440*1440 a 144Hz HDMI 2.0: 3440*1440 a 100 Hz Tipo C:3440*1440 a 60 Hz |
| Frequenza di aggiornamento | 144 Hz |
| Tempo di risposta | OD 4 ms |
| Angolo di visione | ≥ 178° (O) / ≥ 178° (V) |
| Rapporto di contrasto | 1200:1 |
| Supporto VESA | 75 x 75mm |
| Colori | 16,7M |
| Adaptive-Sync | Sì |
| Ingresso segnale | DP 1.4 x 1, HDMI 2.0 x 2, Tipologia C x 1 |
| Ingresso alimentazione | 100-240 V CA, 50/60 Hz, 3,0A |
| Audio | |
| Altoparlanti | No |
| Uscita audio | Sì |
| Accessori | |
| Cavo di alimentazione | Sì |
| Cavo HDMI | Sì |
| Cavo DP | Sì |
| Altre funzioni | |
| Luce blu bassa | Sì |
| Dimensioni fisiche | |
| Dimensioni (con supporto) | 994,1*596,4*286,8mm |
| Dimensioni (senza supporto) | 994,1*418,3*82,4mm |
| Peso netto | 10,98 kg |
| Peso lordo | 14,38 kg |

TABLA DE CONTENIDO

1. Precauciones de seguridad
2. Mantenimiento
3. Contenido de la caja
4. Información general del producto
5. Instalación del pedestal
6. Instalación en pared
7. Opciones de conectividad
8. Indicador luminoso
9. Menús OSD
10. Especificaciones técnicas

1. PRECAUCIONES DE SEGURIDAD

No exponga el monitor a un entorno húmedo, a la lluvia ni a otros líquidos. Para evitar descargas eléctricas debidas a riesgos eléctricos o mecánicos, no abra la carcasa del monitor.

Funcionamiento:

- Mantenga el monitor alejado de la luz solar directa u otras fuentes de calor como puede ser una estufa.
- Mantenga el monitor alejado de cualquier líquido.
- Retire cualquier objeto que pueda caer en los orificios de ventilación.
- Para evitar el sobrecalentamiento, no bloquee los orificios de ventilación.
- No golpee ni deje caer el monitor.

2. MANTENIMIENTO

PRECAUCIÓN: Desenchufe el cable de alimentación de la toma de corriente antes de limpiar el monitor.

- Para limpiar la pantalla, humedezca ligeramente un paño suave y limpio con agua.
- Si es posible, utilice una toallita especial para limpiar pantallas.
- No utilice benceno, diluyentes, amoníaco, limpiadores abrasivos o aire comprimido.
- Las soluciones de limpieza inadecuadas pueden dañar el monitor o dejar una película lechosa en la pantalla o la carcasa.
- Desenchufe el monitor si no la va a utilizar durante un prolongado período de tiempo.
- No exponga el monitor al polvo, a líquidos o a un entorno húmedo.
- En caso de que el monitor entre en contacto con líquidos, límpielo inmediatamente con un paño seco.
- Si se derrama líquido en los orificios de ventilación, no use más el monitor. Póngase en contacto con un técnico de servicio profesional.

Aviso legal:



Los términos HDMI, HDMI High-Definition Multimedia Interface y el logotipo de HDMI son marcas comerciales o marcas registradas de HDMI Licensing, Administrator, Inc. en EE. UU. y otros países.

3. Contenido de la caja

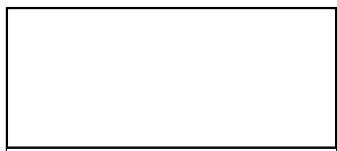

Monitor x 1

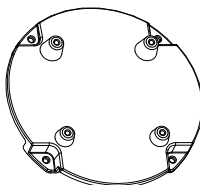

Tapa decorativa
instalada en la pared

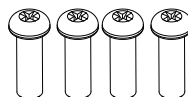

Tornillos PM5*15mm x 4

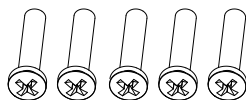

Tornillos M4*16mm x 5
(Instalación en pared)

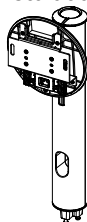

Tubo del pedestal x 1
(con soporte acoplado)

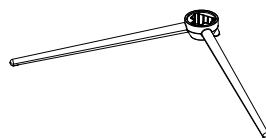

Base del pedestal x1

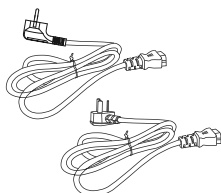

Cable alimentación europeo x 1
Cable alimentación británico x 1

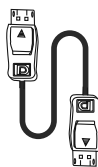

Cable DP x1

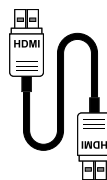

Cable HDMI x 1

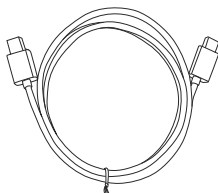

Cable Tipo C



Destornillador x 1



Manual del usuario



Se pueden incluir tornillos adicionales de repuesto.

4. Información general del producto

4.1 — Botones del monitor

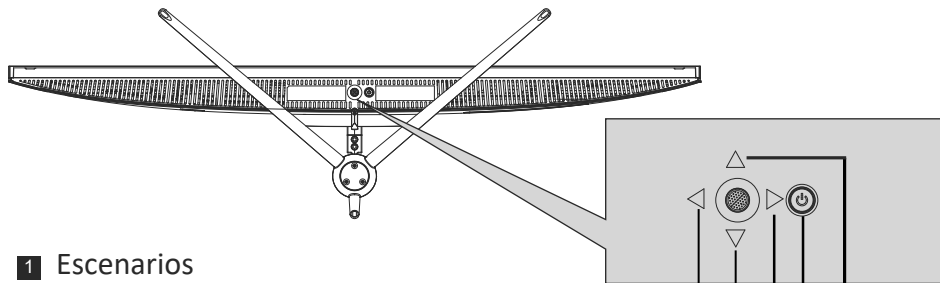

- 1 Escenarios
- 2 Efectos de LED hacia atrás del oscilador.
- 3 Menú principal derecho del oscilador.
- 4 Botón de alimentación: Presione este botón para encender o apagar el monitor.
- 5 GamePlus

4.2 — Puertos del monitor

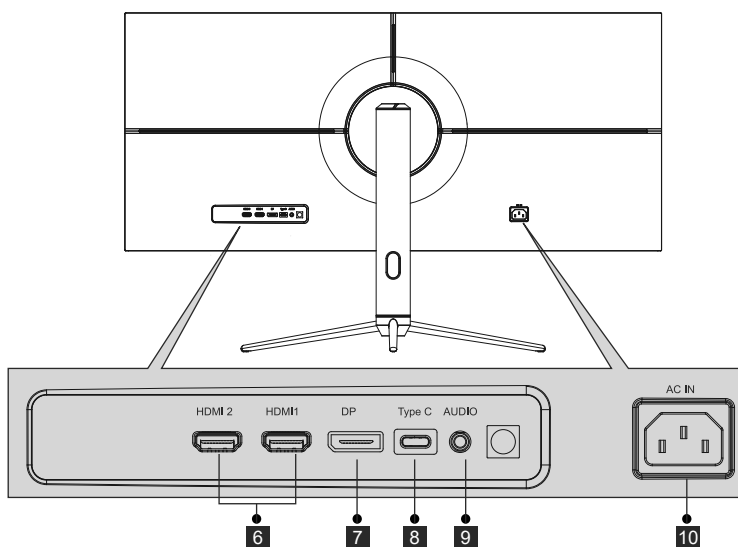

- 6 **Entrada HDMI:** inserte un extremo del cable HDMI en la salida HDMI de su PC y conecte el otro extremo al puerto HDMI del monitor.
- 7 **Conectores DP:** inserte un extremo del cable DP en la salida DP de su PC y conecte el otro extremo al puerto DP del monitor.
- 8 **Tipo-C:** inserte un extremo del cable Tipo-C en la salida Tipo-C de su PC y conecte el otro extremo al puerto Tipo-C del monitor.
- 9 **Salida de audio:** inserte el cable de audio para la salida de señales de audio.
- 10 **Conector de alimentación:** inserte el cable de alimentación para proporcionar energía al monitor.

5. Instalación del pedestal

1. Abra el paquete y, a continuación, saque la espuma y colóquela sobre una mesa.

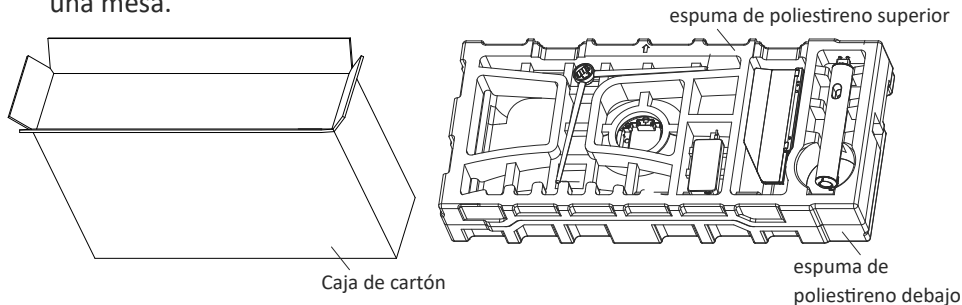

2. Quite la cubierta superior de espuma de poliestireno, saque la carcasa de la bolsa de plástico y colóquela en la cavidad de la cubierta inferior de la espuma de poliestireno nuevamente.

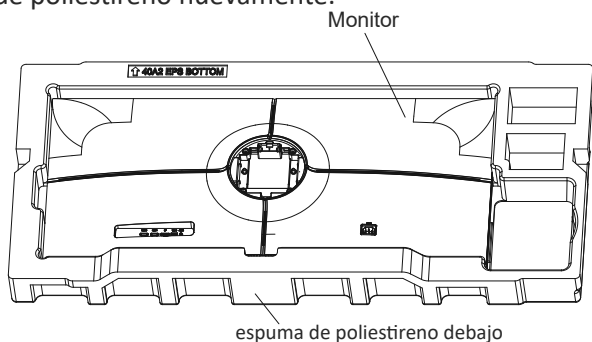

3. Saque el soporte y la base y fíjelos con tres tornillos avellanados PM5*15 mm (incluido un tornillo de repuesto), como se muestra en la figura anterior.

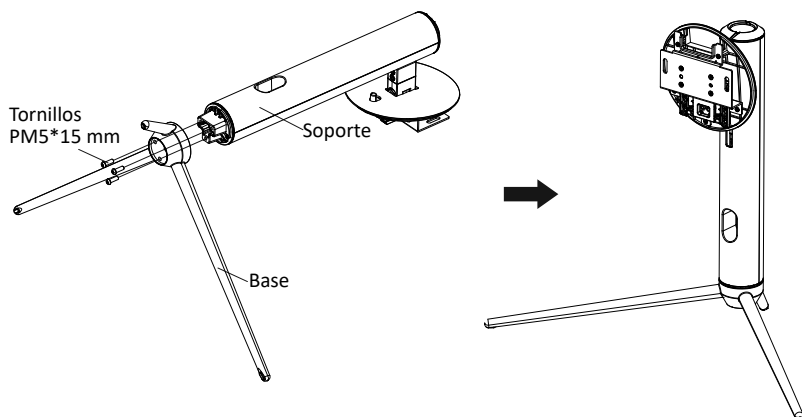

4. Como se muestra en la figura anterior, coloque el ensamblaje de la base montado en el paso 3 en el receptor correspondiente de la carcasa trasera, presione suavemente el soporte para hacer que el ensamblaje del eje se enganche en el seguro, a continuación, sostenga el soporte por su posición central, levante suavemente la carcasa dos veces sin tropezar, con el fin de garantizar que la hebilla pueda bloquear el conjunto de la base. Para realizar el desmontaje, siga los pasos en orden inverso.

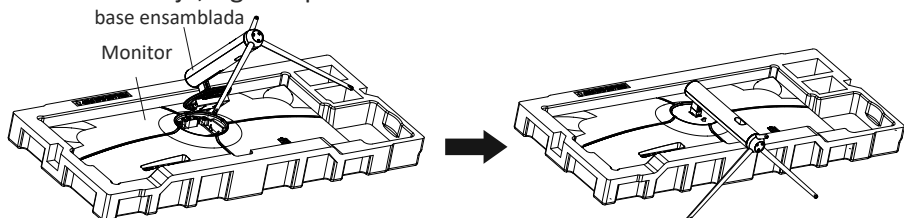

5. Sostenga el eje de soporte con la mano y levante la máquina.
Nota: A la hora de levantar la máquina, no sujete la pantalla ni la ponga boca abajo con las manos para evitar que se rompa la pantalla de dicha máquina.

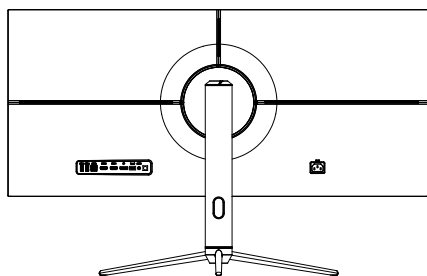
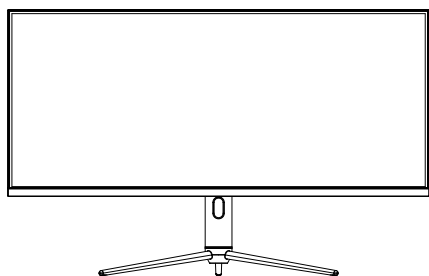

-  Asegúrese de colocar el monitor sobre una superficie plana antes de quitar el pedestal.

6. Instalación en pared



Este monitor solo incluye tornillos que pueden usarse al conectar el monitor a un soporte tipo VESA de 75*75 mm. No se incluye un soporte VESA ni un accesorio de montaje.

1. Abra el paquete y, a continuación, saque la espuma y colóquela sobre una mesa.

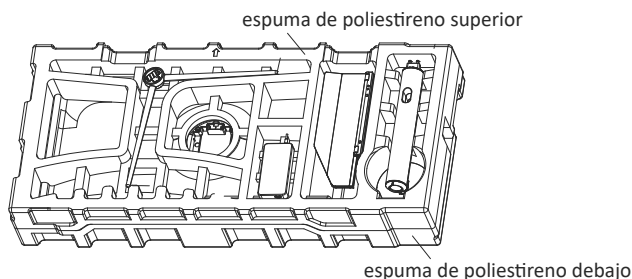

2. Quite la cubierta superior de espuma de poliestireno, saque la carcasa de la bolsa de plástico y colóquela en la cavidad de la cubierta inferior de poliestireno nuevamente.

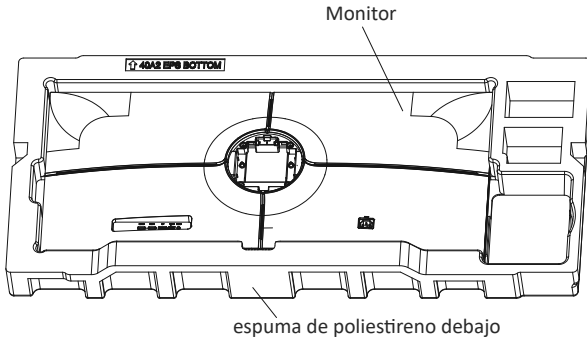

3. Retire la cubierta decorativa colgante del interior del accesorio, bloquee el orificio de la rosca M4 en el medio de la carcasa con los 4 tornillos PM4*16 y bloquéelo con un destornillador (por ejemplo, el perno representativo verde).

El adaptador instalado en la pared se ensambla en el medio de toda la máquina (fijado con tornillos PM4*16 incluidos en el paquete de accesorios)

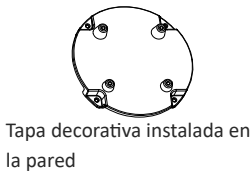

Cinco tornillos PM4*16, incluida una pieza de repuesto

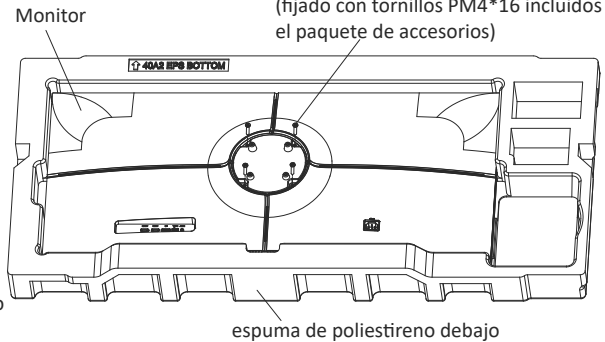

4. No toque la pantalla directamente con las manos durante el funcionamiento del montaje en pared.

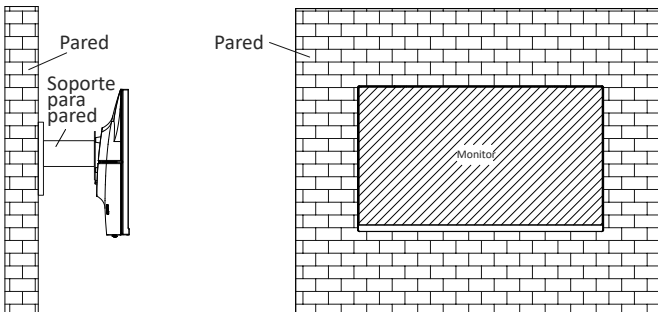

7. Opciones de conectividad

1. Inserte un extremo del cable DP en la tarjeta gráfica de su PC. También se puede usar un cable HDMI. El cable HDMI se incluye.
2. Enchufe el otro extremo del cable en el conector correspondiente del monitor.

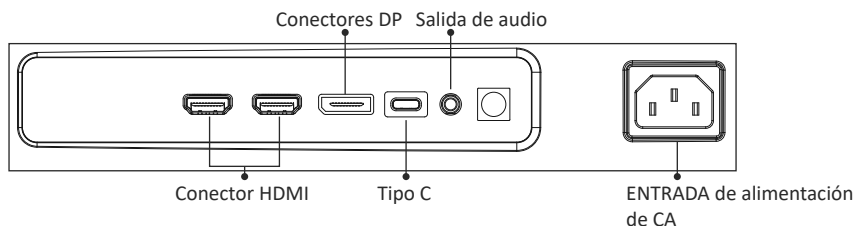

3. Conecte el cable de alimentación al monitor y, a continuación, conecte el otro extremo a la fuente de alimentación. Se recomienda utilizar un protector contra sobretensiones con un voltaje adecuado si no se puede acceder directamente a una toma de corriente.
4. Localice el botón de alimentación del monitor y presiónelo para encenderlo.

8. Indicador luminoso

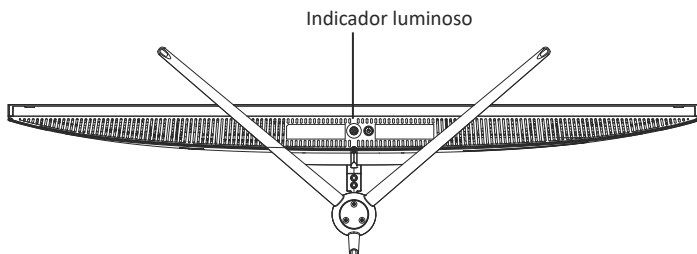

Indicador luminoso





La luz azul fija indica que la alimentación está activada y que el monitor está funcionando con normalidad. La luz roja intermitente indica que no hay fuente de video, no se ha detectado ninguna señal horizontal o vertical o que la energía es baja. Asegúrese de que el equipo esté encendido y que todos los cables de vídeo estén completamente insertados y/o conectados.

9. Menús OSD

El menú de visualización en pantalla (OSD) se puede usar para ajustar la configuración del monitor y aparece en la pantalla después de encender el monitor y presionar el botón M.

 Cuando use el monitor por primera vez, la configuración se ajustará automáticamente a la configuración óptima de acuerdo con la configuración y las partes de su PC, etc.





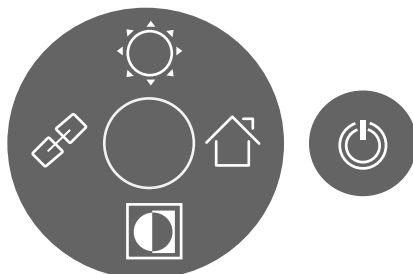



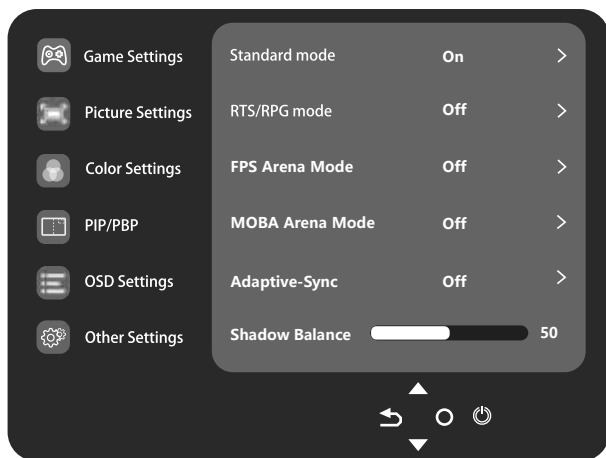

Menú OSD

1. Presione cualquiera de los botones (, , , , ) para activar la ventana de navegación.



2. Presione () para entrar en la pantalla OSD.



3. Presione  o  para navegar por la función.
- Seleccione la función que desee y presione  para entrar en el submenú.
 - Presione  o  para navegar por el submenú y, a continuación, presione  para confirmar la selección de la función deseada.
 - Presione  o  para resaltar una opción y, a continuación, presione  para confirmar la configuración y salir del menú actual.
4. Presione  para salir de la interfaz de menú.

10. Especificaciones técnicas

| | |
|--------------------------------|---|
| Modelo | LC-M40-UWQHD-144 |
| Tamaño de la pantalla | 40" |
| Relación de aspecto | 21:9 |
| Luz de fondo | E-LED |
| Brillo | 400 cd/m ² (valor típico) |
| Panel | ADS (IPS) |
| Resolución | DP1.4: 3440*1440 a 144Hz HDMI 2.0: 3440*1440 a 100 Hz Tipo-C: 3440*1440 a 60 Hz |
| Tasa de actualización | 144 Hz |
| Tiempo de respuesta | OD 4 ms |
| Ángulo de visión | ≥ 178° (H) / ≥ 178° (V) |
| Relación de contraste | 1200:1 |
| Soporte VESA | 75 x 75mm |
| Colores | 16,7 millones |
| Adaptive-Sync | Sí |
| Señal de entrada | DP 1.4*1, HDMI 2.0*2, Tipo C*1 |
| Entrada de alimentación | 100-240 VCA, 50/60 Hz 3.0A |
| Audio | |
| Altavoces | No |
| Salida de audio | Sí |
| Accesorios | |
| Cable de alimentación | Sí |
| Cable HDMI | Sí |
| Cable DP | Sí |
| Funciones adicionales | |
| Luz Azul baja | Sí |
| Dimensiones físicas | |
| Dimensiones (con base) | 994,1*596,4*286,8mm |
| Dimensiones (sin base) | 994,1*418,3*82,4mm |
| Peso neto | 10,98 kg |
| Peso bruto | 14,38 kg |

LC-POWER™

Silent power Electronics GmbH

Formerweg 8

47877 Willich

Germany

www.lc-power.com