

Desktop Monitor Arm with Clamp



Istruzioni installazione
Installation Instruction

ICA-LCD 501BK



Gentile Cliente,

grazie per aver scelto un prodotto Techly.

Istruzioni disimballaggio

- Aprire il cartone con cura, rimuovere il contenuto e distenderlo su un cartone o altro materiale protettivo per evitare danni.
- Verificare che il contenuto della confezione corrisponda alla lista delle parti nella pagina successiva per assicurarsi che tutti i componenti siano presenti e non siano danneggiati. Non utilizzare parti difettose o danneggiate.
- Leggere attentamente le istruzioni riportate nel presente manuale prima di procedere all'installazione.
- Tenere sempre questo manuale per future consultazioni.

Importanti informazioni sulla sicurezza

- Installare e utilizzare questo prodotto con cura. Leggere cortesemente le istruzioni prima di cominciare l'installazione e seguire scrupolosamente tutte le indicazioni contenute qui. Utilizzare adeguati dispositivi di sicurezza durante l'installazione.
- Contattare del personale qualificato per effettuare l'installazione se non avete compreso le indicazioni contenute in questo manuale o avete dei dubbi in merito alla sicurezza dell'installazione.

Non utilizzate il prodotto per uno scopo o in una configurazione non espressamente specificata in queste istruzioni. Si declina qualsiasi responsabilità per danni derivanti da un errato assemblaggio, errato montaggio o uso non corretto del prodotto.

Al termine delle operazioni di montaggio assicurarsi che il tutto sia stato effettuato a regola d'arte.

Dear Customer,

thanks for choosing a Techly product. Enjoy the using.

Unpacking Instructions

- Carefully open the carton, remove contents and lay out on cardboard or other protective surface to avoid damage.
- Check package contents against the Supplied Parts List in the next page to assure that all components were received undamaged. Do not use damaged or defective parts.
- Carefully read all instructions before attempting installation.
- Please keep the instruction manual for next consultations.

Important Safety Information

- Install and operate this device with care. Please read this instruction before installation, and carefully follow all instructions contained herein. Use proper safety equipment during installation.
- Please call a qualified installation contractor for help if you don't understand these directions or have any doubts about the safety of the installation.

Do not use this product for any purpose or in any configuration not explicitly specified in this instruction. We hereby disclaims any and all liability for injury or damage arising from incorrect assembly, incorrect mounting, or incorrect use of this product.

At the end of the fixing care that the support is installed in the correct way.



ATTENZIONE: Questo supporto per monitor da scrivania deve essere posizionato sulla scrivania in modo sicuro. Se il montaggio non è stato effettuato in modo corretto e stabile, ciò potrebbe causare la caduta della staffa, determinando lesioni o danni a cose e persone.



CAUTION: This TV Desk mount must be securely attached to the horizontal desk. If the mount is not properly installed it may fall, resulting in possible injury and/or damage.

LISTA DELLE PARTI FORNITE | SUPPLIED PARTS LIST

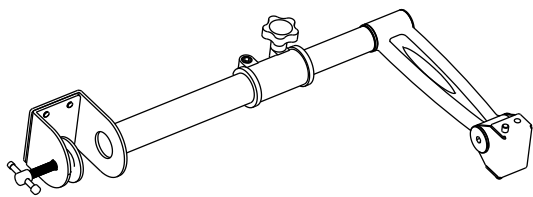

(1) Supporto da scrivania assemblato-a
(1) Desk bracket assembled -a

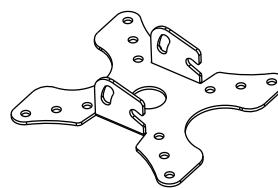

(1) Supporto monitor-b
(1) Monitor bracket -b

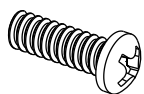

(4) M4x12 Vite-c
(4) M4x12 Bolt-c

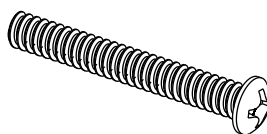

(4) M4x30 Vite-d
(4) M4x30 Bolt-d

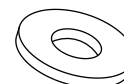

(8) M4 Rondella-e
(8) M4 Washer-e

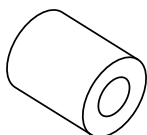

(4) M4 Distanziatore-f
(4) M4 Space-f

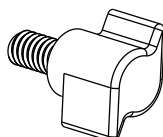

(2) Manopola di sicurezza-g
(2) Safety knob-g

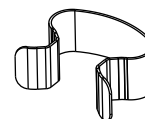

(1) Anello passacavo-h
(1) Cable ring-h

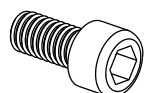

2x Vite a brugola (i)
2x Allen Bolt (i)



2 x Rondella dentellata (j)
2 x Spring Washer (j)

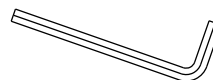

1 x Chiave a brugola (k)
1 x Allen Key (k)



(2) M6 Rondella (l)
(2) M6 Washer (l)

STEP 1 Montaggio del supporto alla scrivania | Mounting the bracket to the Desk

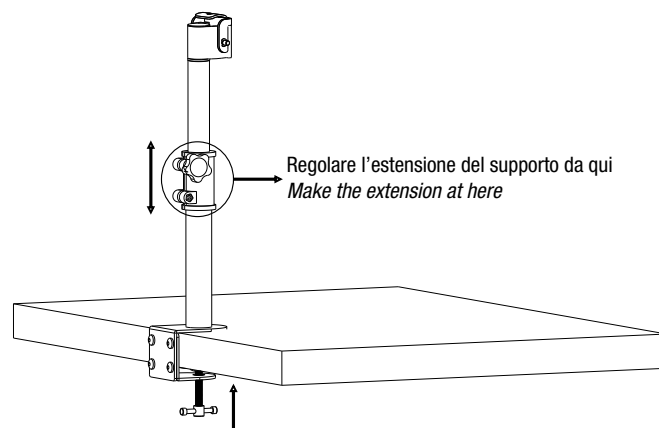
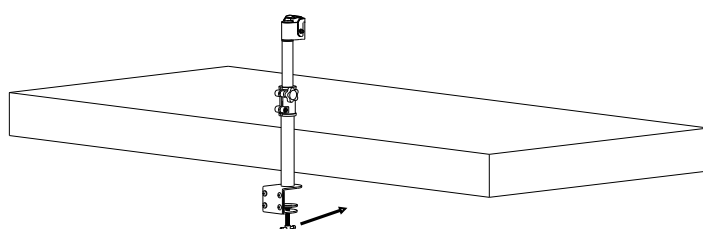

STEP 2 Montare la placca per il monitor alla TV | *Mounting the Monitor Bracket to the TV*

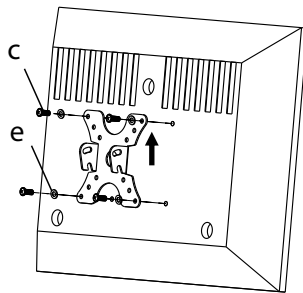

Per TV con retro piatto
For flat back TV

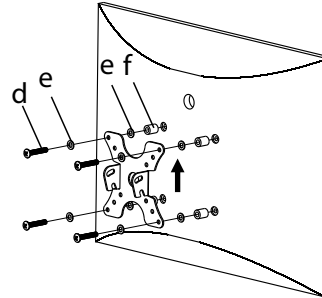

Per TV con retro curvo
For curved back TV

STEP 3 Fissare il monitor al supporto da scrivania e aggiungere la manopola | *Attaching monitor to desktop bracket and adding the knobs*

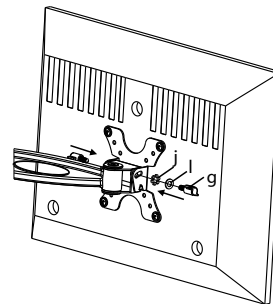
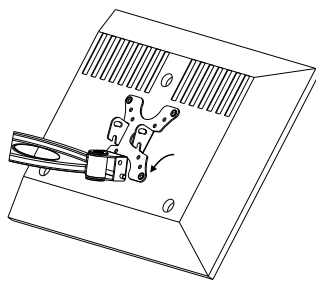

Nota: e' possibile utilizzare le 2 viti a brugola (i) invece della manopola di plastica se avete difficoltà a fissare l'angolo di inclinazione della TV.
Remarks: You can use the supplied 2pcs Allen Bolt (i) to instead of plastic knobs if you have problem to fix the TV tilting angle.

STEP 4 Installare l'anello passacavi sul braccio | *Install the Cable Management Ring on the Arm*

