



# 3.0 CLASSROOM

LA SCELTA MIGLIORE PER LA CLASSE MODULARE

Banchi modulari, sedie e moduli esagonali

Le nuove metodologie didattiche rendono necessario riorganizzare la disposizione della classe in tempi brevi per assecondare le più svariate esigenze di apprendimento, garantendo al contempo la massima sicurezza di studenti e docenti. Per soddisfare questa esigenza abbiamo studiato una soluzione modulare completa di banchi, sedie ergonomiche e moduli esagonali centrali per postazioni circolari composte da più banchi. Gli arredi CLASSE 3.0 sono capaci di adattarsi alle diverse esigenze della scuola di

oggi: dalle postazioni singole per la classica lezione frontale a configurazioni multiple a isola, a ferro di cavallo o lineari, capaci di ospitare gruppi di 2, 4, 6 o più studenti e perfetti per attività collaborative.

**Tutte le soluzioni sono disponibili con diverse altezze per andare incontro alle diverse stature degli studenti e rispondono sia alla normativa CE sulla sicurezza che ai requisiti stabiliti dal D.Lgs. n. 81/2008. Sono inoltre certificati come UNI EN 1729-1:2016.**



ZGD65-GRGR-2-L2T  
ZGD65-GRGR-3-L2T



H-ZGD65-ORGR-2-L2T  
H-ZGD65-ORGR-3-L2T



H-ZGD65-BLGR-2-L2T  
H-ZGD65-BLGR-3-L2T



ZGD65-GRGR-2M-L2T  
ZGD65-GRGR-3M-L2T



ZGD65-GRGR-2S-L2T  
ZGD65-GRGR-3S-L2T

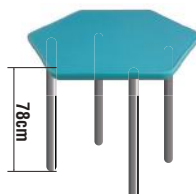

ZGD65-GRGR-2-ES2  
ZGD65-GRGR-3-ES2

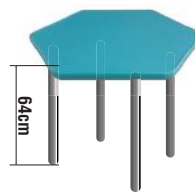

ZGD65-GRGR-2M-ES  
ZGD65-GRGR-3M-ES

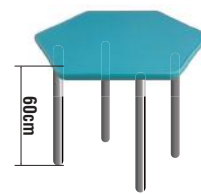

ZGD65-GRGR-2S-ES2  
ZGD65-GRGR-3S-ES2



YGD52-GRGR-2  
YGD52-GRGR-3



H-YGD52-ORGR-2  
H-YGD52-ORGR-3



YGD52-BLGR-2  
H-YGD52-BLGR-3



YGD52-GRGR-2M2  
YGD52-GRGR-3M2



YGD52-GRGR-2S2  
YGD52-GRGR-3S2



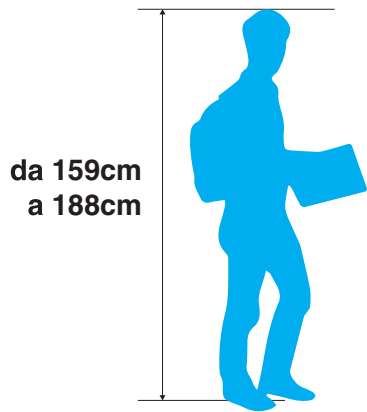

**GRANDEZZA 6**

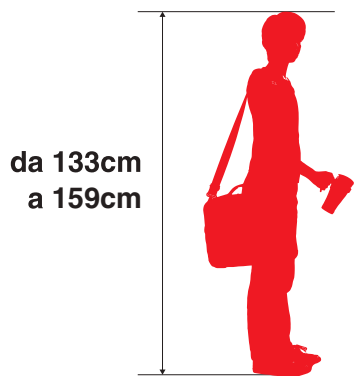
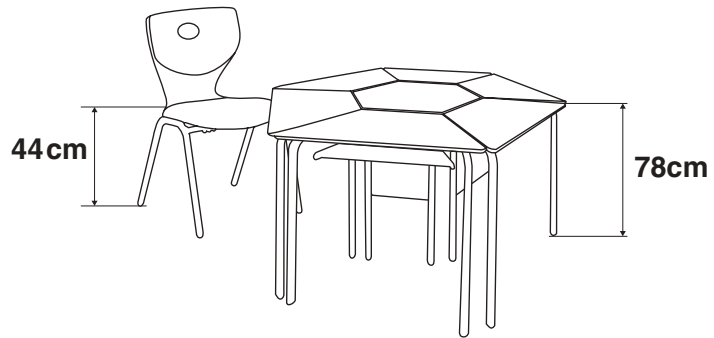

**GRANDEZZA 4**

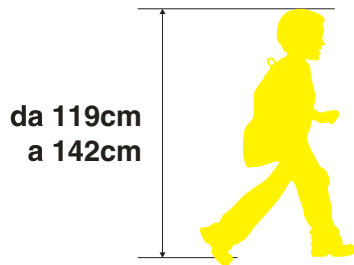
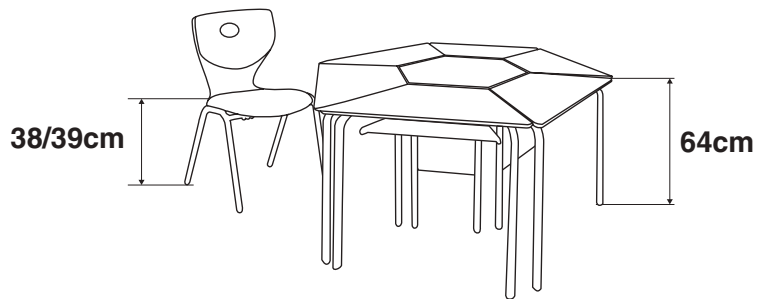

**GRANDEZZA 3**

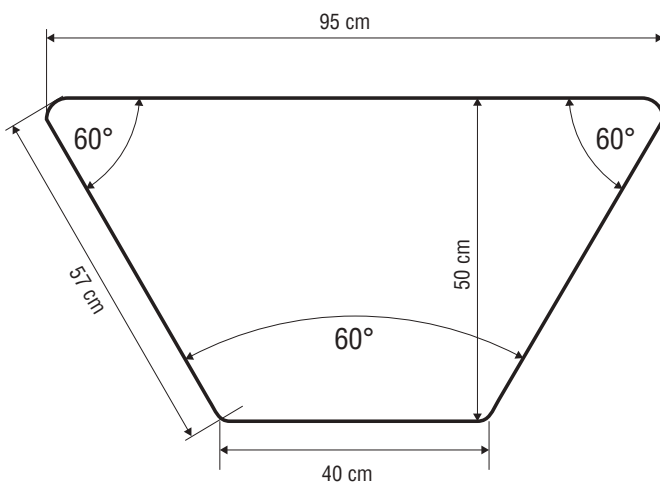
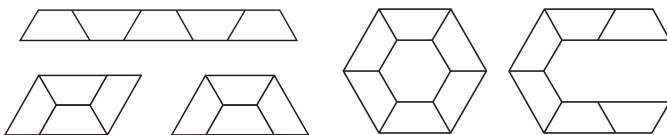
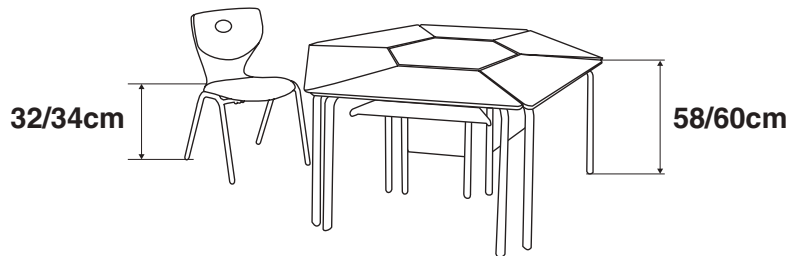

ZGD65-GRGR-2S-L2  
ZGD65-GRGR-3S-L2



ZGD65-GRGR-2S-L  
ZGD65-GRGR-3S-L

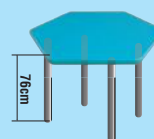

ZGD65-GRGR-2-ES  
ZGD65-GRGR-3-ES

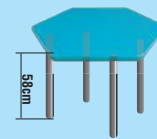

ZGD65-GRGR-2S-ES  
ZGD65-GRGR-3S-ES



YGD52-GRGR-2S  
YGD52-GRGR-3S

**PRODOTTI  
FINE SERIE**



	Codice	Grandezza	Altezza	Dimensioni	Colore	Specifiche tecniche	
BANCO MODULARE	ZGD65-GRGR-2-L2T	6	78	95 x 57 x 40 cm Profondità 50 cm	Grigio/Verde	<b>Struttura</b> Metallo verniciato a polveri epossidiche colore grigio chiaro. <b>Piano di lavoro</b> Melaminico antigraffio sagomato arrotondato, risbordato in ABS. <b>Angoli</b> in 60°.	
	ZGD65-GRGR-3-L2T						
	H-ZGD65-ORGR-2-L2T				Grigio/Arancio		
	H-ZGD65-ORGR-3-L2T						
	H-ZGD65-BLGR-2-L2T				Grigio/Blu		
	H-ZGD65-BLGR-3-L2T						
	ZGD65-GRGR-2M-L2T	4	64		Grigio/Verde		
	ZGD65-GRGR-3M-L2T						
	ZGD65-GRGR-2S-L2T	3	60				
	ZGD65-GRGR-3S-L2T						
MODULO ESAGONALE	ZGD65-GRGR-2-ES2	6	78	Lato 40 cm	Grigio/Verde	<b>Struttura</b> Metallo verniciato a polveri epossidiche colore grigio chiaro. <b>Piano di lavoro</b> Melaminico antigraffio sagomato arrotondato, risbordato in ABS. <b>Angoli</b> in 60°.	
	ZGD65-GRGR-3-ES2						
	ZGD65-GRGR-2M-ES	4	64				
	ZGD65-GRGR-3M-ES						
	ZGD65-GRGR-2S-ES2	3	60				
	ZGD65-GRGR-3S-ES2						
SEDIA ERGONOMICA	YGD52-GRGR-2	6	44	43,5 x 43,5 cm	Grigio/Verde	<b>Struttura</b> Tubolare da 1,5cm verniciato a polveri epossidiche colore grigio chiaro. <b>Seduta</b> Materiale plastico antiurto.	
	YGD52-GRGR-3						
	H-YGD52-ORGR-2				Grigio/Arancio		
	H-YGD52-ORGR-3						
	YGD52-BLGR-2				Grigio/Blu		
	H-YGD52-BLGR-3						
	YGD52-GRGR-2M2	4	39		39 x 37 cm		Grigio/Verde
	YGD52-GRGR-3M2						
	YGD52-GRGR-2S2	3	34		33 x 31 cm		Grigio/Verde
	YGD52-GRGR-3S2						