

# GUIDA RAPIDA



## GRAZIE PER AVER ACQUISTATO UN PRODOTTO HOTPOINT - ARISTON

Per ricevere un'assistenza più completa,  
registrare il prodotto su  
[www.hotpoint.eu/register](http://www.hotpoint.eu/register)



Scaricare le istruzioni per la sicurezza e le  
istruzioni per l'uso collegandosi al sito  
[docs.hotpoint.eu](http://docs.hotpoint.eu) e seguire la procedura  
indicata sul retro.

**! Leggere attentamente le istruzioni per la sicurezza prima di utilizzare il prodotto**

## DESCRIZIONE PRODOTTO

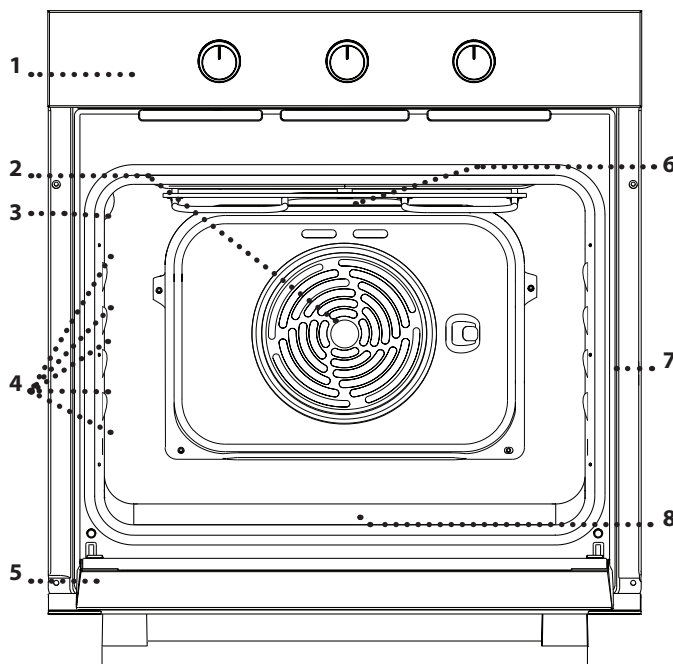

1. Pannello di controllo
2. Ventola
3. Lampada
4. Guide accessori  
(il livello è indicato sulla parete  
della cavità)
5. Porta
6. Resistenza superiore / Grill
7. Targhetta matricola  
(da non rimuovere)
8. Resistenza inferiore  
(non visibile)

## PANNELLO DI CONTROLLO

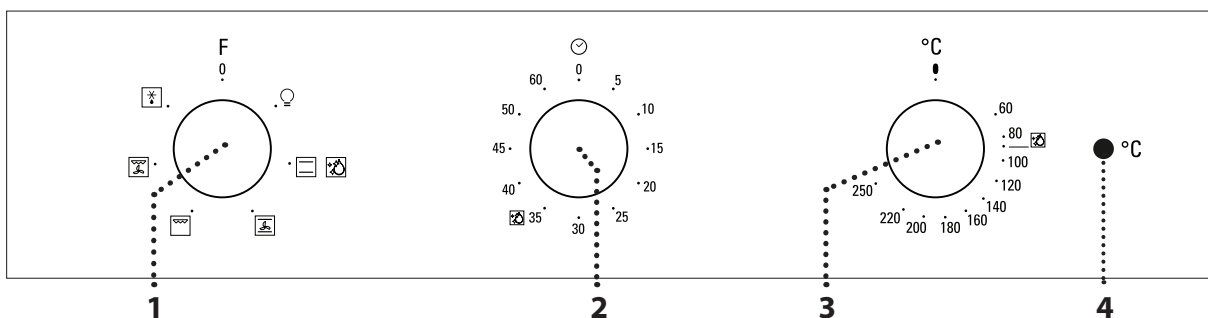

### 1. MANOPOLA DI SELEZIONE

Per accendere il forno  
selezionando una funzione.  
Per spegnere il forno, ruotare sulla  
posizione 0.

### 2. MANOPOLA TIMER

Utile come contaminuti.  
Non attiva né interrompe una  
cottura.

### 3. MANOPOLA TERMOSTATO

Ruotare per selezionare la  
temperatura desiderata attivando  
la funzione selezionata.

### 4. LED TERMOSTATO / PRERISCALDAMENTO

Si accende durante la fase di  
riscaldamento. Si spegne al  
raggiungimento della temperatura  
desiderata.

## GRIGLIA

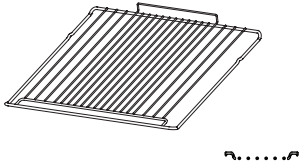

## PIASTRA DOLCI

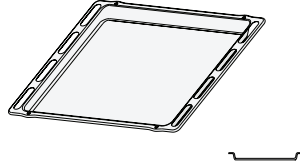

Il numero di accessori può variare a seconda del modello acquistato.  
È possibile acquistare separatamente altri accessori presso il Servizio Assistenza Clienti.

## INSERIRE LA GRIGLIA E ALTRI ACCESSORI

. Inserire la griglia tenendola leggermente inclinata verso l'alto, appoggiando dapprima il lato posteriore rialzato - orientato verso l'alto - sul livello desiderato. In seguito, farla scivolare orizzontalmente sulle guide accessori fino a fine corsa.

. Gli altri accessori, come la piastra dolci, si inseriscono orizzontalmente facendoli scivolare sulle guide accessori.

# FUNZIONI

**0 OFF**  
Per spegnere il forno.

**LUCE**  
Per accendere la luce di cavità.

**STATICO**  
Per cuocere qualsiasi tipo di pietanza su un solo ripiano. E' preferibile utilizzare il 2° livello.

**DIAMOND CLEAN**  
L'azione del vapore rilasciato durante questo speciale ciclo di pulizia a bassa temperatura permette di rimuovere facilmente sporco e residui di cibo. Versare 200ml di acqua potabile sul fondo del forno e utilizzare la funzione per 35' a 90°C. Attivare la funzione a forno freddo e lasciare raffreddare 15' al termine del ciclo.

**VENTILATO**  
Per cuocere torte con ripieno liquido su singolo ripiano. Questa funzione può essere utilizzata anche per cotture su due ripiani. Invertire la posizione degli alimenti per ottenere una cottura più omogenea.

**GRILL**  
Per grigliare costate, spiedini e salsicce, gratinare verdure o dorare il pane. Per la grigliatura delle carni, si consiglia di utilizzare una leccarda per raccogliere il liquido di cottura: posizionarla un livello sotto la griglia e aggiungere 200 ml di acqua potabile.

**TURBOGRILL**  
Per arrostitire grossi pezzi di carne (cosciotti, roast beef, polli). Si consiglia di utilizzare una leccarda per raccogliere il liquido di cottura: posizionarla un livello sotto la griglia e aggiungere 500 ml di acqua potabile.

**SCONGELAMENTO**  
Per velocizzare lo scongelamento degli alimenti.

# PRIMO UTILIZZO

## RISCALDARE IL FORNO

Un nuovo forno può rilasciare degli odori dovuti alla lavorazione di fabbrica: questo è normale. Prima di cucinare gli alimenti è dunque raccomandato di riscaldare a vuoto il forno per rimuovere ogni odore.

Rimuovere protezioni di cartone o pellicole trasparenti e togliere gli accessori dal forno.

Riscaldare il forno vuoto alla temperatura di 250° per circa 1 ora utilizzando preferibilmente la funzione "Ventilato". Seguire le istruzioni a seguire per impostare correttamente la funzione.

Note: è opportuno ventilare la stanza durante e dopo il primo utilizzo.

# USO QUOTIDIANO

## 1. SELEZIONARE UNA FUNZIONE

Per selezionare una funzione, ruotare la *manopola di selezione* in corrispondenza del simbolo della funzione desiderata.

## 2. AVVIARE UNA FUNZIONE

### MANUALE

Per avviare la funzione selezionata, ruotare la *manopola termostato* per impostare la temperatura desiderata.

Per interrompere in ogni momento, spegnendo il forno, ruotare la *manopola di selezione* e la *manopola termostato* su 0 e ●.

### DIAMOND CLEAN

Per attivare la funzione di pulizia "Diamond clean", dopo aver versato 200 ml di acqua potabile sul fondo della cavità del forno, ruotare la *manopola di selezione* e la *manopola termostato* in corrispondenza dell'icona .

Si consiglia di utilizzare la funzione per 35'.

## 3. PRERISCALDAMENTO

Una volta avviata la funzione, il led termostato acceso segnala che si è attivata la fase di preriscaldamento. Al termine di questa fase, il led termostato si spegne indicando che il forno ha raggiunto la temperatura impostata: a questo punto, inserire gli alimenti e procedere alla cottura.

Note: inserire gli alimenti nel forno prima della fine del preriscaldamento può compromettere i risultati di cottura.

## . IMPOSTARE IL TIMER

















Questa opzione non interrompe né attiva una cottura ma permette di utilizzare il contaminuti, sia durante una funzione attiva che quando il forno è spento.

Per avviare il contaminuti, ruotare la manopola timer sulla durata desiderata: un segnale acustico avviserà del termine del conto alla rovescia.

# TABELLA DI COTTURA

RICETTA	FUNZIONE	PRE RISCALDARE	TEMPERATURA (°C)	DURATA (MIN)	LIVELLO E ACCESSORI
<b>Torte a lievitazione</b>		Sì	150 - 170	30 - 90	2
		Sì	150 - 170	30 - 90 ***	4  1
<b>Torte ripiene</b> (cheese cake, strudel, torta di frutta)		Sì	160 - 200	35 - 90	2
		Sì	160 - 200	35 - 90 ***	4  2
<b>Biscotti/Tortine</b>		Sì	160 - 180	15 - 35	2 / 3
		Sì	150 - 170	20 - 40 ***	4  2
<b>Bignè</b>		Sì	180 - 200	40 - 60	2
		Sì	170 - 190	35 - 50 ***	4  2
<b>Meringhe</b>		Sì	90	150 - 200	2
		Sì	90	140 - 200 ***	4  2
<b>Pizza / Focaccia</b>		Sì	220 - 250	10 - 25	1 / 2
		Sì	200 - 240	15 - 30 ***	4  2
<b>Panini 80 g</b>		Sì	180 - 200	30 - 45	2
<b>Pane in cassetta 500 g</b>		Sì	180	50 - 70	1 / 2
<b>Pane</b>		Sì	180 - 200	30 - 80 ***	4  2
		Sì	250	10 - 20	2
<b>Pizze surgelate</b>		Sì	250	10 - 20 ***	4  2
		Sì	180 - 200	30 - 45	2
<b>Torte salate</b> (torta di verdura, quiche)		Sì	170 - 200	40 - 60 ***	4  2
		Sì	190 - 200	20 - 30	2
<b>Voulevant / Salatini di pasta sfoglia</b>		Sì	180 - 190	15 - 40 ***	4  2
		Sì	190 - 200	45 - 65	2
<b>Lasagna / Pasta al forno / Cannelloni / Sformati</b>		Sì	190 - 200	45 - 65	2
<b>Agnello / Vitello / Manzo / Maiale 1 kg</b>		Sì	190 - 200	80 - 110	2

ACCESSORI					
	Griglia	Tortiera o teglia su griglia	Piastra dolci / Teglia su griglia	Piastra dolci con 200ml di acqua	Piastra Dolci

RICETTA	FUNZIONE	PRE RISCALDARE	TEMPERATURA (°C)	DURATA (MIN)	LIVELLO E ACCESSORI
Arrosto di maiale con cotenna 2 kg		Sì	180 - 190	110 - 150	2
Pollo / Coniglio / Anatra 1 kg		Sì	200 - 230	50 - 100	2
Tacchino / Oca 3 kg		Sì	180 - 200	150 - 200	2
Pesce al forno / al cartoccio 0,5 kg (filetto, intero)		Sì	170 - 190	30 - 45	2
Verdure ripiene (pomodori, zucchine, melanzane)		Sì	180 - 200	50 - 70	2
Pane tostato		5'	250	2 - 6	5
Filetti / tranci di pesce		5'	250	15 - 30 *	4 3
Salsicce / Spiedini / Costine / Hamburger		5'	250	15 - 30 *	5 4
Pollo arrosto 1-1,3 kg		-	200 - 220	60 - 80 **	3 1
Roast beef al sangue 1 kg		-	200	35 - 50 **	3
Cosciotto di agnello / Stinchi		-	200	60 - 90 **	3
Patate arrosto		-	200 - 220	35 - 55 **	3
Verdure gratinate		-	200 - 220	25 - 55	3
Lasagna & Carne		Sì	200	50 - 100 ****	4 1
Carne & Patate		Sì	190 - 200	45 - 100 ****	4 1
Pesce & Verdure		Sì	180	30 - 50 ****	4 2





\* Ruotare il cibo a metà cottura

\*\* Ruotare il cibo a due terzi di cottura se necessario.

\*\*\* Invertire i livelli a metà cottura.

\*\*\*\* La durata è approssimata: le pietanze possono essere tolte dal forno in tempi differenti secondo preferenza. Invertire i livelli a due terzi della cottura se necessario.

Scaricare le Istruzioni per l'uso collegandosi al sito [docs.hotpoint.eu](https://docs.hotpoint.eu) per consultare la tabella delle ricette testate, compilata per gli istituti di valutazione secondo la norma IEC 60350-1.

FUNZIONI				
	Statico	Grill	Turbo Grill	Ventilato

## COME LEGGERE LA TABELLA DI COTTURA

La tabella indica la funzione, gli accessori e il livello migliore da utilizzare per cuocere svariati tipi di cibo. I tempi di cottura si riferiscono all'introduzione del cibo nel forno, escluso il preriscaldamento (dove richiesto). Le temperature e i tempi di cottura sono indicativi e dipendono dalla quantità di cibo e dal tipo di accessori. Utilizzare inizialmente i valori più bassi consigliati e, se il risultato della cottura non è quello desiderato, passare a quelli più alti. Si consiglia di utilizzare gli accessori in dotazione e tortiere o teglie possibilmente in metallo scuro. È possibile utilizzare

anche pentole e accessori in pyrex o in ceramica, i tempi di cottura si allungheranno leggermente.

## CUCINARE DIFFERENTI ALIMENTI CONTEMPORANEAMENTE

Utilizzando la funzione "Ventilato", è possibile cuocere contemporaneamente cibi diversi (ad esempio: pesce e verdure), su ripiani diversi. Estrarre i cibi che richiedono tempi di cottura inferiori e lasciare continuare la cottura per quelli con tempi più lunghi.

## CURA E PULIZIA

**Non usare pulitrici a getto di vapore.**

**Utilizzare guanti protettivi durante tutte le operazioni.**

**Eeguire le operazioni indicate a forno freddo.**

**Scollegare l'apparecchio dalla rete elettrica.**

**Non usare pagliette metalliche, panni abrasivi e detersivi abrasivi o corrosivi che possano danneggiare le superfici.**

### SUPERFICI ESTERNE

- Pulire le superfici con un panno in microfibra umido. Se molto sporche, aggiungere qualche goccia di detersivo neutro. Asciugare con un panno asciutto.
- Non usare detersivi corrosivi o abrasivi. Se inavvertitamente uno di questi prodotti dovesse venire a contatto con le superfici, pulire subito con un panno in microfibra umido.

### SUPERFICI INTERNE

- Dopo ogni uso, lasciare raffreddare il forno e pulirlo preferibilmente quando è ancora tiepido per rimuovere incrostazioni e macchie dovute a residui di cibo; per asciugare la condensa dovuta alla cottura di alimenti con un elevato contenuto di acqua, usare a forno freddo un panno o una spugna.

- Attivare la funzione "Diamond Clean" per una pulizia ottimale delle superfici interne.
- Per facilitare la pulizia dei vetri è possibile rimuovere e smontare facilmente la porta.
- Pulire i vetri della porta con detersivi liquidi specifici.
- La resistenza superiore del grill può essere abbassata per pulire la parete superiore del forno.

### ACCESSORI

Mettere a bagno gli accessori con detersivo per piatti dopo l'uso, maneggiandoli con guanti da forno, se ancora caldi. I residui di cibo possono essere rimossi con una spazzola per piatti o con una spugna.

## ABBASSARE LA RESISTENZA SUPERIORE

**1.** Estrarre la resistenza dalla sua sede, quindi abbassarla.

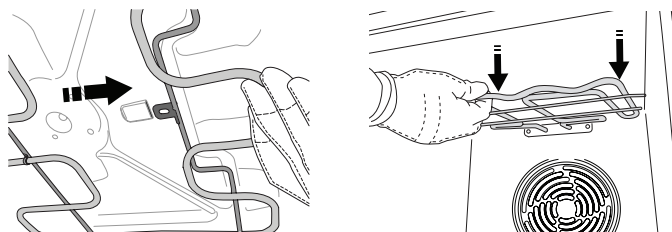

**2.** Per riposizionare la resistenza, sollevarla, tirandola leggermente verso di sé, assicurandosi infine di inserire la linguetta di supporto nella propria sede.

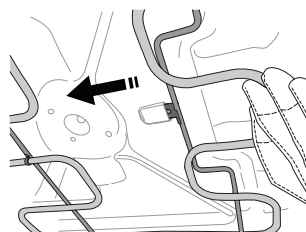

## TOGLIERE E RIMONTARE LA PORTA

**1.** Per rimuovere la porta, aprirla completamente e abbassare i fermi fino alla posizione di sblocco.

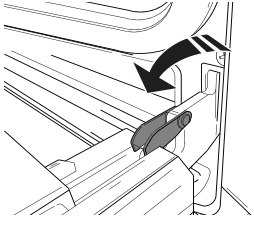

**2.** Chiudere la porta fino a quando è possibile. Prendere saldamente la porta con entrambe le mani, evitando di tenerla per la maniglia. Per estrarla facilmente, continuare a chiuderla e contemporaneamente tirarla verso l'alto (a) finché non esce dalle sedi (b).

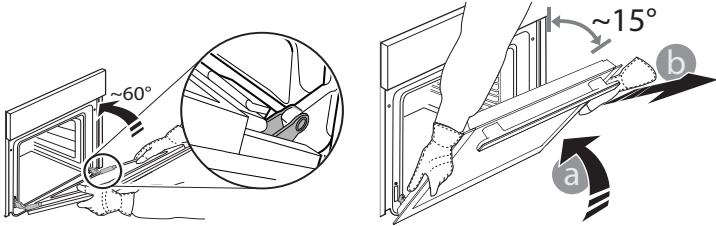

Togliere la porta e appoggiarla su un piano morbido.

**3.** Per rimontare la porta, avvicinarla al forno allineando i ganci delle cerniere alle proprie sedi e ancorare la parte superiore agli alloggiamenti.

**4.** Abbassare la porta e poi aprirla completamente. Abbassare i fermi nella posizione originale: fare attenzione che siano completamente abbassati.

**5.** Provare a chiudere la porta, verificando che sia allineata al pannello di controllo. Se non lo fosse, ripetere tutte le operazioni.

## CLICK TO CLEAN - PULIRE I VETRI

**1.** Dopo aver smontato la porta e averla appoggiata su un ripiano morbido con la maniglia verso il basso, premere contemporaneamente le due clip di fissaggio ed estrarre il profilo superiore della porta tirandolo verso di sé.

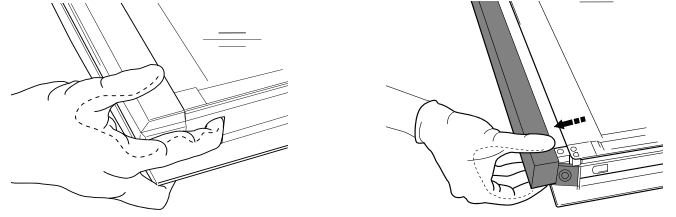

**2.** Sollevare e prendere saldamente il vetro interno con due mani, rimuoverlo e appoggiarlo su un piano morbido prima di eseguire la pulizia.

**3.** Per riposizionare correttamente il vetro interno, fare attenzione che la "R" sia leggibile nell'angolo sinistro. Inserire dapprima il lato lungo del vetro indicato dalla "R" nelle sedi di sostegno, quindi abbassarlo in posizione.

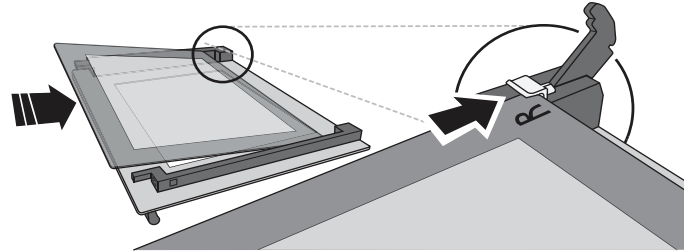

**4.** Rimontare il profilo superiore: un clic indica il corretto posizionamento. Verificare che la tenuta sia salda prima di rimontare la porta.

Problema	Possibile causa	Soluzione
Il forno non funziona	Interruzione di corrente elettrica Disconnessione dalla rete principale	Verificare che ci sia tensione in rete e che il forno sia collegato all'alimentazione elettrica. Spegner e riaccendere il forno e verificare se l'inconveniente persiste

## SCHEDA TECNICA

La scheda del prodotto comprensiva dei dati energetici di questo forno può essere scaricata dal sito internet [docs.hotpoint.eu](http://docs.hotpoint.eu)

## COME OTTENERE LE ISTRUZIONI PER L'USO

> Scaricare le istruzioni per l'uso dal sito internet [docs.hotpoint.eu](http://docs.hotpoint.eu) (è possibile usare questo QR Code) indicando il codice commerciale del prodotto.



> In alternativa, contattare il Servizio di Assistenza Clienti

## CONTATTARE IL SERVIZIO ASSISTENZA CLIENTI

I contatti possono essere trovati sul manuale di garanzia. Quando si contatta il Servizio di Assistenza Clienti fornire i codici presenti sulla targhetta matricola del prodotto.

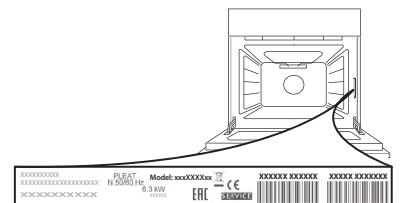



# DAILY REFERENCE GUIDE



## THANK YOU FOR PURCHASING AN HOTPOINT-ARISTON PRODUCT

To receive more comprehensive help and support, please register your product at [www.hotpoint.eu/register](http://www.hotpoint.eu/register)



You can download the Safety Instructions and the Use and Care Guide by visiting our website [docs.hotpoint.eu](http://docs.hotpoint.eu) and following the instructions on the back of this booklet.



**Before using the appliance carefully read the Health and Safety guide.**

## PRODUCT DESCRIPTION

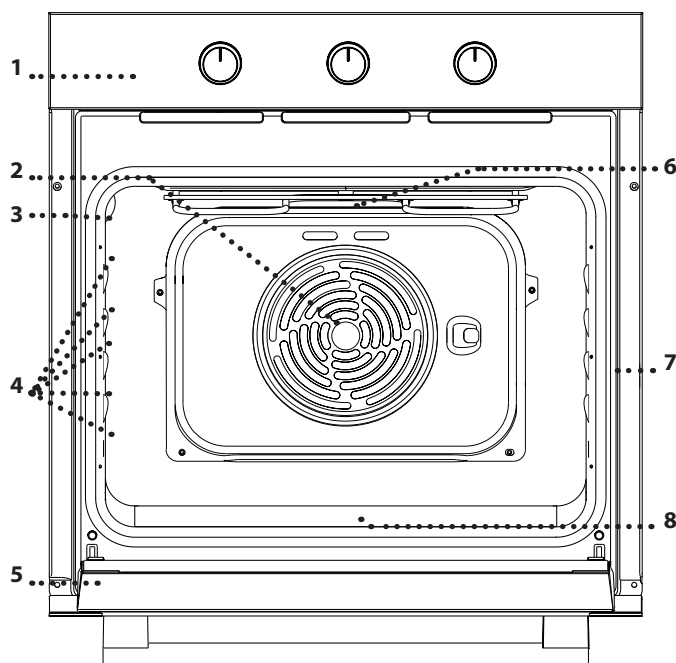

1. Control panel
2. Fan
3. Lamp
4. Runners for accessories  
(the level is indicated on the wall of the cooking compartment)
5. Door
6. Upper heating element / grill
7. Identification plate  
(do not remove)
8. Lower heating element  
(not visible)

## CONTROL PANEL

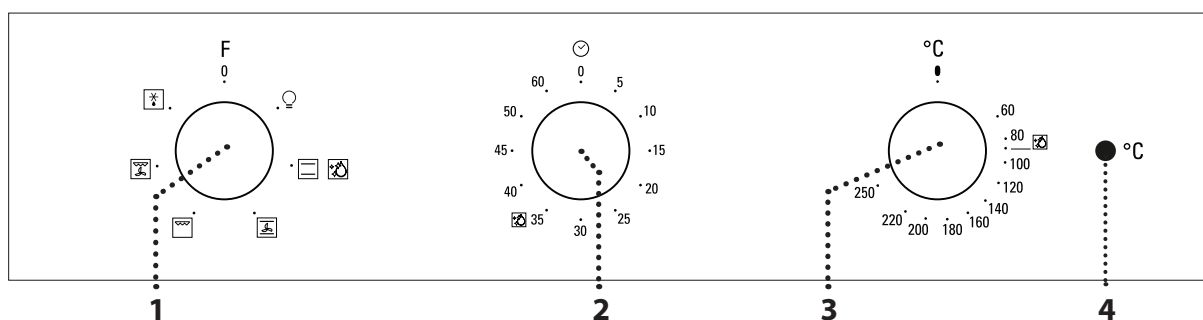

### 1. SELECTION KNOB

For switching the oven on by selecting a function. Turn to the 0 position to switch the oven off.

### 2. TIMER KNOB

Useful as a timer. Does not activate or interrupt cooking.

### 3. THERMOSTAT KNOB

Turn to select a desired temperature, activating the selected function.

### 4. LED THERMOSTAT / PREHEATING

Switches on during the heating process. Switches off once the desired temperature is reached.

## WIRE SHELF

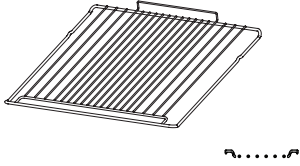

## BAKING TRAY

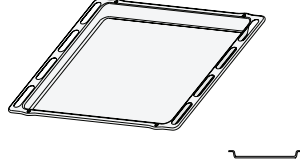

The number of accessories may vary depending on which model is purchased. Other accessories can be purchased separately from the After-sales Service.

## INSERTING THE WIRE SHELF AND OTHER ACCESSORIES

. Insert the wire shelf onto the level you require by holding it tilted slightly upwards and resting the raised rear side (pointing upwards) down first. Afterwards, slide it horizontally along the runners as far as possible.

. The other accessories, such as the baking tray, are inserted horizontally by sliding them along the runners.

# FUNCTIONS



### OFF

For switching off the oven.



### LIGHT

For switching on the light in the compartment.



### CONVENTIONAL

For cooking any kind of dish on one shelf only. It is best to use the 2nd shelf.



### DIAMOND CLEAN

The action of the steam released during this special low-temperature cleaning cycle allows dirt and food residues to be removed with ease. Pour 200 ml of drinking water on the bottom of the oven and use the function for 35' at 90°C. Activate the function when the oven is cold and let it cool down for 15' once the cycle ends.



### CONVECTION BAKE

For baking cakes with juicy fillings on a single shelf. This function can also be used for cooking on two shelves. Switch the position of the dishes to cook food more evenly.



### GRILL

For grilling steaks, kebabs and sausages, cooking vegetables au gratin or toasting bread. When grilling meat, we recommend using a drip tray to collect the cooking juices: Position the tray on any of the levels below the wire shelf and add 200 ml of drinking water.



### TURBO GRILL

For roasting large joints of meat (legs, roast beef, chicken). We recommend using a drip tray to collect the cooking juices: Position the tray on any of the levels below the wire shelf and add 500 ml of drinking water.



### DEFROSTING

For defrosting food more quickly.

# USING THE APPLIANCE FOR THE FIRST TIME

## HEAT THE OVEN

A new oven may release odours that have been left behind during manufacturing: this is completely normal.

Before starting to cook food, we therefore recommend heating the oven with it empty in order to remove any possible odours.

Remove any protective cardboard or transparent film from the oven and remove any accessories from inside it.

Heat the oven to 250° C for about one hour, preferably using the “Convection bake” function. The oven must be empty during this time. Follow the instructions for setting the function correctly.

Notes: it is advisable to air the room after using the appliance for the first time.

## DAILY USE

### 1. SELECT A FUNCTION

To select a function, turn the *selection knob* to the symbol for the function you require:.

### 2. ACTIVATE A FUNCTION

#### MANUAL

To start the function you have selected, turn the *thermostat knob* to set the temperature you require.

To interrupt the function at any time, switch off the oven, turn the *selection knob* and the *thermostat knob* to 0 and 0.

#### DIAMOND CLEAN

To activate the “Diamond Clean” cleaning function, pour 200 ml of drinking water into the bottom of the oven, then turn the *selection knob* and the *thermostat knob* to the  icon.

It is best to use the function for 35’.

### 3. PREHEATING

Once the function has been activated, the LED thermostat will switch on signalling that the preheating process has begun.

At the end of this process, the LED thermostat switches off indicating that the oven has reached the set temperature: at this point, place the food inside and proceed with cooking.

























































Please note: Placing the food in the oven before preheating has finished may have an adverse effect on the final cooking result.





### . SETTING THE TIMER







































This option does not interrupt or activate cooking but allows you to use the display as a timer, both while a function is active and when the oven is off.

To activate the timer, turn the timer knob to the desired length of time: an acoustic signal will warn you when the count-down is finished.

# COOKING TABLE

RECIPE	FUNCTION	PREHEAT	TEMPERATURE (°C)	DURATION (MIN)	LEVEL AND ACCESSORIES
<b>Leavened cakes</b>		Yes	150 - 170	30 - 90	2 
		Yes	150 - 170	30 - 90 ***	4  1 
<b>Filled cake</b> (cheesecake, strudel, fruit pie)		Yes	160 - 200	35 - 90	2 
		Yes	160 - 200	35 - 90 ***	4  2 
<b>Biscuits / tartlets</b>		Yes	160 - 180	15 - 35	2 / 3 
		Yes	150 - 170	20 - 40 ***	4  2 
<b>Choux buns</b>		Yes	180 - 200	40 - 60	2 
		Yes	170 - 190	35 - 50 ***	4  2 
<b>Meringues</b>		Yes	90	150 - 200	2 
		Yes	90	140 - 200 ***	4  2 
<b>Pizza / bread</b>		Yes	220 - 250	10 - 25	1 / 2 
		Yes	200 - 240	15 - 30 ***	4  2 
<b>Sandwiches 80 g</b>		Yes	180 - 200	30 - 45	2 
<b>Bread loaf 500 g</b>		Yes	180	50 - 70	1 / 2 
<b>Bread</b>		Yes	180 - 200	30 - 80 ***	4  2 
		Yes	250	10 - 20	2 
<b>Frozen pizza</b>		Yes	250	10 - 20 ***	4  2 
		Yes	180 - 200	30 - 45	2 
<b>Salty cakes</b> (vegetable pie, quiche)		Yes	170 - 200	40 - 60 ***	4  2 
		Yes	190 - 200	20 - 30	2 
<b>Vol-au-vent / puff pastry crackers</b>		Yes	180 - 190	15 - 40 ***	4  2 
		Yes	190 - 200	45 - 65	2 
<b>Lamb / veal / beef / pork 1 kg</b>		Yes	190 - 200	80 - 110	2 

ACCESSORIES	 Rack	 Baking dish or baking tray on the wire shelf	 Baking tray / oven tray on wire shelf	 Baking tray with 200 ml of water	 BAKING TRAY
-------------	--	--	---	--	---

RECIPE	FUNCTION	PREHEAT	TEMPERATURE (°C)	DURATION (MIN)	LEVEL AND ACCESSORIES
Roast pork with crackling 2 kg		Yes	180 - 190	110 - 150	
Chicken / rabbit / duck 1 kg		Yes	200 - 230	50 - 100	
Turkey / goose 3 kg		Yes	180 - 200	150 - 200	
Baked fish / en papillote 0.5 kg (fillet, whole)		Yes	170 - 190	30 - 45	
Stuffed vegetables (tomatoes, courgettes, aubergines)		Yes	180 - 200	50 - 70	
Toasted bread		5'	250	2 - 6	
Fish fillets / slices		5'	250	15 - 30 *	 
Sausages / kebabs / spare ribs / hamburgers		5'	250	15 - 30 *	 
Roast chicken 1-1.3 kg		-	200 - 220	60 - 80 **	 
Roast beef rare 1 kg		-	200	35 - 50 **	
Leg of lamb / knuckle		-	200	60 - 90 **	
Roast potatoes		-	200 - 220	35 - 55 **	
Vegetable gratin		-	200 - 220	25 - 55	
Lasagna and meat		Yes	200	50 - 100 ****	 
Meat and potatoes		Yes	190 - 200	45 - 100 ****	 
Fish and vegetables		Yes	180	30 - 50 ****	 

\* Turn food halfway through cooking

\*\* Turn food two thirds of the way through cooking (if necessary).

\*\*\* Switch levels halfway through cooking.

\*\*\*\* Estimated length of time: dishes can be removed from the oven at different times depending on personal preference. Switch shelves two-thirds of the way through cooking, if necessary.

Download the Use and Care Guide from [docs.hotpoint.eu](https://docs.hotpoint.eu) for the table of tested recipes, compiled for the certification authorities in accordance with the standard IEC 60350-1.

FUNCTIONS				
	Conventional	Grill	Turbo Grill	Convection Bake

## HOW TO READ THE COOKING TABLE

The table lists the best function, accessories and level to use to cook different types of food. Cooking times start from the moment food is placed in the oven, excluding preheating (where required). Cooking temperatures and times are approximate and depend on the amount of food and the type of accessory used. Use the lowest recommended settings to begin with and, if the food is not cooked enough, then switch to higher settings. Use the accessories supplied and preferably dark-coloured metal cake tins and baking trays. You can also use Pyrex or stoneware

pans and accessories, but bear in mind that cooking times will be slightly longer.

## COOKING DIFFERENT FOODS AT THE SAME TIME

Using the "Convection Bake" function, you can cook different foods simultaneously (for example: fish and vegetables), on different levels. Remove the food which requires a shorter cooking time and leave the food which requires a longer cooking time in the oven.

# MAINTENANCE AND CLEANING

**Do not use steam cleaning equipment.**

**Use protective gloves during all operations.**

**Carry out the required operations with the oven cold.**

**Disconnect the appliance from the power supply.**

**Do not use wire wool, abrasive scourers or abrasive/corrosive cleaning agents, as these could damage the surfaces of the appliance.**

## EXTERIOR SURFACES

- Clean the surfaces with a damp microfibre cloth. If they are very dirty, add a few drops of pH-neutral detergent. Finish off with a dry cloth.
- Do not use corrosive or abrasive detergents. If any of these products inadvertently comes into contact with the surfaces of the appliance, clean immediately with a damp microfibre cloth.

## INTERIOR SURFACES

- After every use, leave the oven to cool and then clean it, preferably while it is still warm, to remove any deposits or stains caused by food residues. To dry any condensation that has formed as a result of cooking foods with a high water content, let the oven to cool completely and then wipe it with a cloth or sponge.

- Activate the "Diamond Clean" function for optimum cleaning of the internal surfaces.
- The door can be easily removed and refitted to facilitate cleaning of the glass.
- Clean the glass in the door with a suitable liquid detergent.
- The top heating element of the grill can be lowered to clean the upper panel of the oven .

## ACCESSORIES

Soak the accessories in a washing-up liquid solution after use, handling them with oven gloves if they are still hot. Food residues can be removed using a washing-up brush or a sponge.

## LOWERING THE UPPER HEATING ELEMENT

**1.** Extract the heating element from its seating, then lower it.

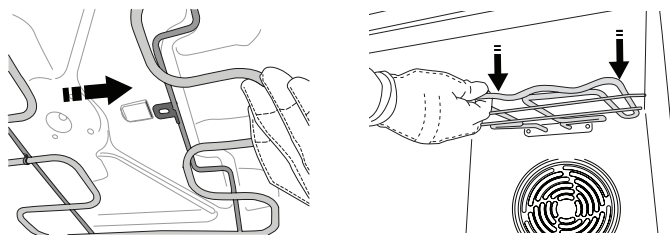

**2.** To return the heating element to its position, lift it up, pull it slightly towards you and make sure that the tab support is in its proper seating.

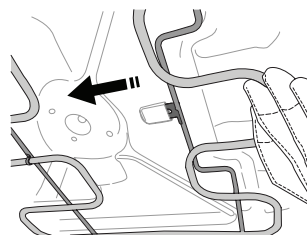

## REMOVING AND REFITTING THE DOOR

**1.** To remove the door, open it fully and lower the catches until they are in the unlock position.

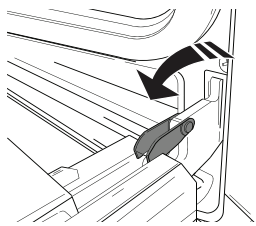

**2.** Close the door as much as you can. Take a firm hold of the door with both hands – do not hold it by the handle. Simply remove the door by continuing to close it while pulling it upwards (a) at the same time until it is released from its seating (b).

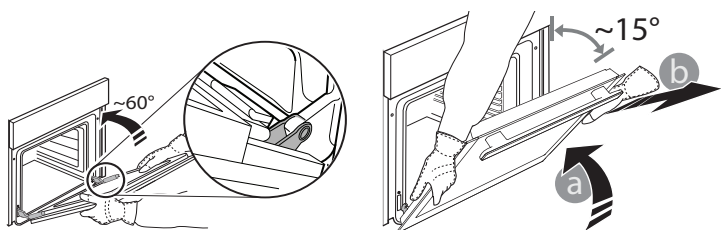

Put the door to one side, resting it on a soft surface.

**3.** Refit the door by moving it towards the oven, aligning the hooks of the hinges with their seating and securing the upper part onto its seating.

**4.** Lower the door and then open it fully. Lower the catches into their original position: Make sure that you lower them down completely.

**5.** Try closing the door and check to make sure that it lines up with the control panel. If it does not, repeat the steps above.

## CLICK TO CLEAN - CLEANING THE GLASS

**1.** After removing the door and resting it on a soft surface with the handle downwards, simultaneously press the two retaining clips and remove the upper edge of the door by pulling it towards you.

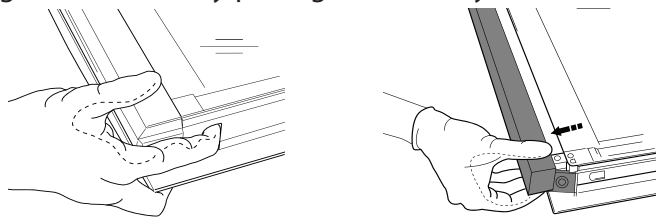

**2.** Lift and firmly hold the inner glass with both hands, remove it and place it on a soft surface before cleaning it.

**3.** To reposition the internal glass properly, be sure that the "R" can be seen in the left corner. First insert the long side of the glass indicated by "R" into the support seats, then lower it into position.

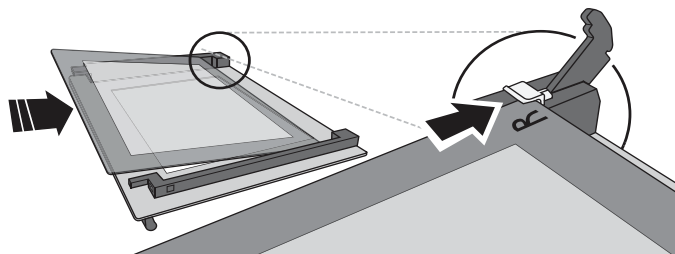

**4.** Refit the upper edge: A click will indicate correct positioning. Make sure the seal is secure before refitting the door.

Problem	Possible cause	Solution
The oven does not work	Power cut Disconnection from the mains	Check for the presence of mains electrical power and whether the oven is connected to the electricity supply. Switch off the oven and restart it to see if the fault persists

## PRODUCT FICHE

The product fiche with energy data of this appliance can be downloaded from the website [docs.hotpoint.eu](http://docs.hotpoint.eu)

## HOW TO OBTAIN THE USE AND CARE GUIDE

> Download the Use and Care Guide from our website [docs.hotpoint.eu](http://docs.hotpoint.eu) (you can use this QR Code), specifying the product's commercial code.



> Alternatively, contact our Client After-sales Service

## CONTACTING OUR AFTER-SALES SERVICE

You can find our contact details in the warranty manual. When contacting our Client After-sales Service, please state the codes provided on your product's identification plate.

