

GUIDE D'UTILISATION QUOTIDIENNE



**MERCI D'AVOIR CHOISI UN PRODUIT
HOTPOINT-ARISTON**
Afin de recevoir un service et un support
complet, merci d'enregistrer votre appareil
sur www.hotpoint.eu/register



Vous pouvez télécharger les Consignes de
sécurité et le Guide d'utilisation et entretien en
visitant notre site Web www.hotpoint.eu et
en suivant les consignes au dos de ce livret.



Lisez attentivement les consignes de sécurité avant d'utiliser l'appareil

DESCRIPTION DU PRODUIT

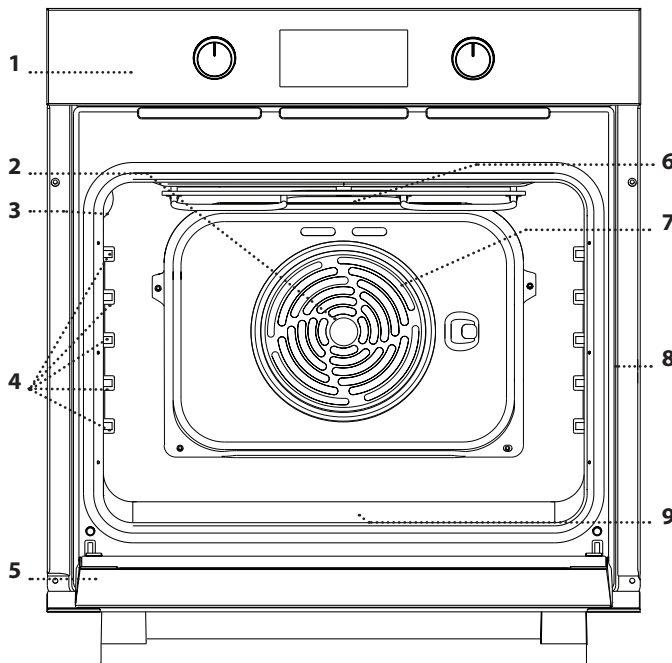

1. Bandeau de commande
2. Ventilateur
3. Lampe
4. Supports de grille
(le niveau est indiqué sur la paroi
du compartiment de cuisson)
5. Porte
6. Élément chauffant supérieur/gril
7. Élément chauffant rond
(invisible)
8. Plaque signalétique
(ne pas enlever)
9. Élément chauffant inférieur
(invisible)

PANNEAU DE COMMANDES

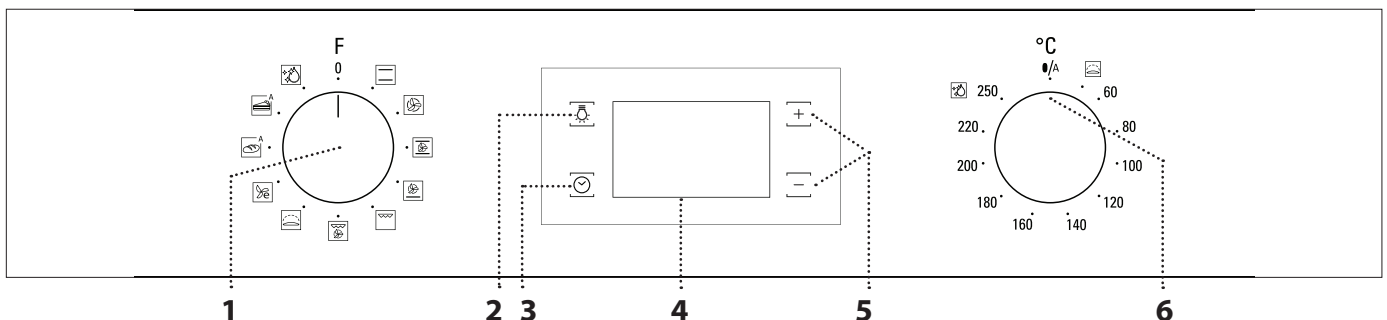

1. BOUTON DE SÉLECTION

Pour allumer le four en
sélectionnant une fonction.
Tournez à la position 0 pour
éteindre le four.

2. LAMPE

Avec le four allumé, appuyez pour
allumer ou éteindre l'ampoule du
compartiment du four.

3. RÉGLAGE DE L'HEURE

Pour accéder les réglages pour le
temps de cuisson, le départ différé,
et la minuterie. Pour afficher
l'heure lorsque le four est éteint.

4. ÉCRAN

5. BOUTONS DE RÉGLAGES

Pour changer les réglages du
temps de cuisson.

6. BOUTON THERMOSTAT

Tournez pour sélectionner la
température désirée lorsque vous
utilisez les fonctions manuelles.
Utilisation des fonctions
automatique 0/A.

Hotpoint

ARISTON

GRILLE MÉTALLIQUE

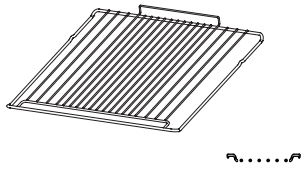

LÈCHEFRITE

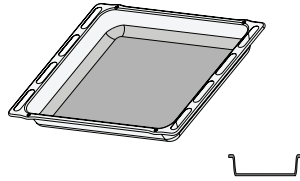

PLAQUE DE CUISSON

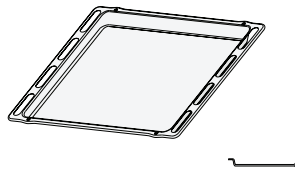

Le nombre d'accessoires peut varier en fonction du modèle acheté. Il est possible d'acheter séparément d'autres accessoires auprès du Service Après-Vente.

INSÉRER LA GRILLE MÉTALLIQUE ET LES AUTRES ACCESSOIRES

• Insérez la grille métallique au niveau désiré en la tenant légèrement inclinée vers le haut et en déposant la partie surélevée arrière (pointant vers le haut) en premier. Glissez-la ensuite horizontalement sur le support de grille aussi loin que possible.

• Les autres accessoires, comme la lèchefrite et la plaque de cuisson, sont introduits horizontalement en les glissant le long des supports de grille.

FONCTIONS

TRADITIONNEL*
Pour cuire tout type de plat sur une seule grille.

CHALEUR PULSÉE
Pour cuire différents aliments demandant la même température de cuisson sur plusieurs grilles (maximum de trois) en même temps. Cette fonction permet de cuire différents aliments sans transmettre les odeurs d'un aliment à l'autre.

CUISSON GROSSE PIÈCE
Pour cuire de gros morceaux de viande (supérieurs à 2,5 kg). Nous vous conseillons de retourner la viande durant la cuisson pour s'assurer que les deux côtés brunissent de façon égale. Nous vous conseillons d'arroser le rôti de temps en temps pour éviter qu'il ne s'assèche.

PIZZA
Pour cuire différents types et tailles de pain et de pizza. Nous vous conseillons d'échanger la position des plaques de cuisson à la mi-cuisson.

GRIL
Pour cuire des biftecks, des brochettes, et des saucisses, faire gratiner des légumes et griller du pain. Pour la cuisson de la viande, nous vous conseillons d'utiliser une lèchefrite pour recueillir les jus de cuisson : Placez la lèchefrite, contenant 200 ml d'eau, sur n'importe quel niveau sous la grille métallique.

TURBO GRIL
Pour griller de gros morceaux de viande (gigots, rôtis, poulets). Nous vous conseillons d'utiliser une lèchefrite pour recueillir les jus de cuisson : Placez la lèchefrite, contenant 200 ml d'eau, sur n'importe quel niveau sous la grille métallique.

LEVAGE DE LA PÂTE
Pour obtenir une meilleure fermentation des pâtes sucrées ou salées. Pour assurer la qualité de levage, n'activez pas la fonction si le four est encore chaud après un cycle de cuisson.

ÉCO CHALEUR PULSÉE *
Pour cuire les rôtis farcis et les rôtis sur une seule grille. Les aliments ne s'assèchent pas trop grâce à une légère circulation d'air intermittente. Lorsque vous utilisez la fonction ÉCO, le voyant reste éteint durant la cuisson, mais peut être rallumé temporairement en appuyant sur

A PAIN AUTO
Cette fonction sélectionne automatiquement la meilleure température et le meilleur temps de cuisson pour le pain. Pour les meilleurs résultats, suivez minutieusement la recette . Activez la fonction lorsque le four est froid.



A PÂTISSERIES AUTO
Cette fonction sélectionne automatiquement la meilleure température et le meilleur temps de cuisson pour les gâteaux. Activez la fonction lorsque le four est froid.

DIAMOND CLEAN
L'action de la vapeur créée lors de ce cycle de nettoyage à basse température spécial permet d'enlever la saleté et les résidus d'aliments plus facilement. Placez 200 ml d'eau potable au fond de la cavité et lancez la fonction lorsque le four est froid.







* Fonction utilisée comme référence pour la déclaration d'efficacité énergétique conformément au Règlement (UE) n° 65/2014

UTILISER L'APPAREIL POUR LA PREMIÈRE FOIS

1. RÉGLAGE DE L'HEURE

Vous devez régler l'heure lorsque vous allumez l'appareil pour la première fois : Appuyez sur  jusqu'à ce que le voyant  et les deux chiffres indiquant l'heure clignotent à l'écran.



Utilisez  ou  pour régler l'heure et appuyez sur  pour confirmer. Les deux chiffres des minutes clignotent. Utilisez  ou  pour régler les minutes et appuyez sur  pour confirmer.

Veillez noter : Lorsque le voyant  clignote (par exemple après des pannes de courant prolongées), vous devrez régler l'heure de nouveau.

2. RÉCHAUFFER LE FOUR

Un nouveau four peut dégager des odeurs provenant de la fabrication : ceci est parfaitement normal. Avant de cuire des aliments, nous vous conseillons de chauffer le four à vide pour éliminer les odeurs.

Enlevez les cartons de protection ou les pellicules transparentes du four, et enlevez les accessoires qui se trouvent à l'intérieur.

Chauffez le four à 250 °C pour environ une heure, de préférence en utilisant la fonction « Cuisson Grosse pièce ». Le four doit être vide durant cette opération. Suivez les directives pour régler correctement la fonction.

Veillez noter : Nous vous conseillons d'aérer la pièce après avoir utilisé l'appareil pour la première fois.

UTILISATION QUOTIDIENNE

1. SÉLECTIONNER UNE FONCTION

Pour sélectionner une fonction, tournez le *bouton de sélection* sur le symbole de la fonction désirée : l'écran s'illumine et un signal sonore se fait entendre.



2. ACTIVER UNE FONCTION

MANUEL

Pour lancer la fonction que vous avez sélectionnée, tournez le *bouton du thermostat* pour régler la température requise.



Veillez noter : Lors de la cuisson, vous pouvez changer la fonction en tournant le *bouton de sélection* ou ajuster la température en tournant le *bouton du thermostat*. La fonction ne démarre pas tant que le bouton du thermostat est sur 0°C. Vous pouvez régler le temps de cuisson, le temps de fin de cuisson (seulement si vous réglez le temps de cuisson) et la minuterie.

AUTOMATIQUE

Pour lancer la fonction automatique que vous avez sélectionnée (« Pain » ou « Pâtisserie »), placez le *bouton du thermostat* à la position pour les fonctions automatiques (0/A).

Pour terminer la cuisson, tournez le *bouton de sélection* à la position 0.

Veillez noter : Vous pouvez régler le temps de fin de cuisson et la minuterie.

LEVAGE DE LA PÂTE

Pour lancer la fonction « Levage de la pâte », tournez le *bouton thermostat* au symbole correspondant; si le four est réglé à une température différente, la fonction de démarrage pas.

Veillez noter : Vous pouvez régler le temps de cuisson, le temps de fin de cuisson (seulement si vous réglez le temps de cuisson) et la minuterie.

3. PRÉCHAUFFAGE

Une fois que la fonction est lancée, un signal sonore et un voyant  qui clignote à l'écran confirmant que la phase de préchauffage est activée.

À la fin de cette phase, un signal sonore et un voyant stable  indique que le four a atteint la température désirée : vous pouvez maintenant placer les aliments à l'intérieur et débiter la cuisson.

Veillez noter : Placer les aliments dans le four avant que le préchauffage soit terminé peut affecter la cuisson.

. PROGRAMME DE CUISSON

Vous devez sélectionner une fonction avant de pouvoir lancer un programme de cuisson.



DURÉE

Appuyez sur la touche  jusqu'à ce que le voyant  et « 00:00 » clignotent à l'écran.





Utilisez  ou  pour régler la durée de cuisson et appuyez sur  pour confirmer.



Lancez la fonction en tournant le *bouton du thermostat* à la température désirée : un signal sonore se fait entendre et l'écran s'illumine lorsque la cuisson est terminée.

Remarques : Pour annuler le temps de cuisson, appuyez sur  jusqu'à ce que le voyant  clignote sur l'écran, utilisez ensuite  pour remettre le temps de cuisson à « 00:00 ». Ce temps de cuisson inclut la phase de préchauffage.

PROGRAMMER L'HEURE DE FIN DE CUISSON/ DÉPART DIFFÉRÉ

Après avoir réglé le temps de cuisson, vous pouvez retarder le début de la fonction en programmant le temps de fin de cuisson : appuyez sur  jusqu'à ce que l'icône  et l'heure actuelle clignotent à l'écran.



Utilisez  ou  pour régler la durée de cuisson et appuyez sur  pour confirmer. Lancez la fonction en tournant le *bouton du thermostat* à la température désirée : la fonction reste en veille et démarre automatiquement après la période d'attente calculée pour que la cuisson se termine à l'heure désirée.

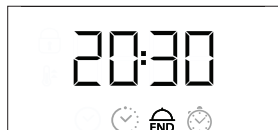

Remarques : Pour annuler le réglage, éteindre le four en tournant le *bouton de sélection* à la position « 0 ».

Le démarrage différé de la fonctionnalité n'est pas disponible pour les fonctions Grill et Turbo-grill.

FIN DE CUISSON

Un signal sonore se fait entendre et l'écran s'illumine pour indiquer que la fonction est terminée.

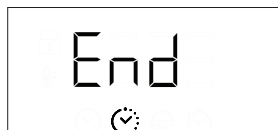

Tournez le *bouton de sélection* pour sélectionner une différente fonction ou le placer à la position « 0 » pour éteindre le four.



Veillez noter : Si la minuterie fonctionne, l'écran affiche « END » en alternance avec le temps restant.



. RÉGLER LA MINUTERIE

Cette option n'interrompt pas ou ne programme pas la cuisson, mais permet d'utiliser l'écran comme minuterie, durant le fonctionnement d'une fonction ou quand le four est éteint.

Appuyez sur la touche  jusqu'à ce que le voyant  et « 00:00 » clignotent à l'écran.



Utilisez  ou  pour régler l'heure désirée et appuyez sur  pour confirmer. Un signal sonore se fait entendre lorsque la minuterie a terminé le compte à rebours.

Remarques : Pour annuler la minuterie, appuyez sur  jusqu'à ce que le voyant  clignote, utilisez ensuite  pour remettre le temps à « 00:00 ».

. FONCTION DIAMOND CLEAN

Pour activer la fonction de nettoyage « Diamond Clean », versez 200 ml d'eau au fond du four, tournez ensuite le *bouton de sélection* et le *bouton du thermostat* sur l'icône .

Veillez noter : La position de l'icône ne correspond pas à la température atteinte lors du cycle de nettoyage.

La fonction s'active automatiquement : l'écran affiche le temps restant avant la fin, en alternance avec « DC ».



Veillez noter : Il est seulement possible de programmer la fin de cette fonction. La durée est automatiquement réglée à 35 minutes.

TABLEAU DE CUISSON

RECETTE	FONCTION	PRÉCHAUFFAGE	TEMPÉRATURE (°C)	DURÉE (MIN)	NIVEAU ET ACCESSOIRES
Gâteaux à pâte levée		Oui	160-180	30-90	2/3
		Oui	160-180	30-90	4 1
gâteau fourré (gâteau au fromage, strudel, tarte aux fruits)		Oui	160 - 200	35 - 90	2
		Oui	160 - 200	40 - 90	4 2
Biscuits/tartelettes		Oui	160-180	20-45	3
		Oui	150 - 170	20-45	4 2
		Oui	150 - 170	20-45	5 3 1
Choux ronds		Oui	180 - 210	30-40	3
		Oui	180-200	35-45	4 2
		Oui	180-200	35-45	5 3 1
Meringues		Oui	90	150 - 200	3
		Oui	90	140 - 200	4 2
		Oui	90	140 - 200	5 3 1
Pizza/pain		Oui	190-250	15-50	1 / 2
		Oui	190-250	20-50	4 2
Pain		-	-	60	2
Pizza surgelée		Oui	250	10 - 20	3
		Oui	230 - 250	10 -25	4 2
Pâtisseries salées (tarte aux légumes, quiche)		Oui	180-200	40-55	3
		Oui	180-200	45 - 60	4 2
		Oui	180-200	45 - 60	5 3 1
Vol-au-vent/biscuits à pâte feuilletée		-	190-200	20 - 30	3
		-	180-190	20-40	4 2
		-	180-190	20-40	5 3 1

FONCTIONS								
	Traditionnel	Gril	Turbo Gril	Pizza	Chaleur pulsée	Cuisson grosse pièce	Pain Auto	Éco Chaleur pulsée

ACCESSOIRES						
	Grille métallique	Casserole ou plaque de cuisson sur la grille	Lèche-frite/plaque de cuisson sur grille métallique	LÈCHEFRITE	Lèche-frite contenant 200 ml d'eau	Plaque de cuisson

RECETTE	FONCTION	PRÉCHAUFFAGE	TEMPÉRATURE (°C)	DURÉE (MIN)	NIVEAU ET ACCESSOIRES
Lasagnes/pâtes au four/cannellonis/tartes		Oui	190-200	45-65	2
Agneau/veau/bœuf/porc 1 kg		Oui	190-200	80-110	3
Rôti de porc avec grattons 2 kg		Oui	180-190	110-150	2
Poulet/lapin/canard 1 kg		Oui	200-230	50-100	2
Dinde/oie 3 kg		-	190-200	100 - 160	2
Poisson au four/en papillote (filet, entier)		Oui	170 - 190	30 - 50	2
Légumes farcis (tomates, courgettes, aubergines)		Oui	180-200	50 - 70	2
Pain grillé		-	250	2 - 6	5
Filets/tranches de poisson		-	230 - 250	20 - 30*	4 3
Saucisses/brochettes/côtes levées/hamburgers		-	250	15 - 30*	5 4
Poulet rôti 1 - 1,3 kg		Oui	200 - 220	55 - 70**	2 1
Rosbif saignant 1 kg		Oui	200 - 210	35 - 50**	3
Gigot d'agneau/jarret		Oui	200 - 210	60 - 90**	3
Pommes de terre rôties		Oui	200 - 210	35 - 55**	3
Gratin de légumes		-	200 - 210	25 - 55	3
Viande et pommes de terre		Oui	190-200	45 - 100***	4 1
Poisson et légumes		Oui	180	30 - 50***	4 1
Lasagnes & viande		Oui	200	50 - 100***	4 1
Repas complet : tarte aux fruits (niveau 5)/lasagne (niveau 3)/viande (niveau 1)		Oui	180-190	40 - 120***	5 3 1
Rôtis/rôtis farcis		-	170 - 180	100 - 150	2

Le temps indiqué n'inclut pas la phase de préchauffage : Nous vous conseillons de placer les aliments dans le four et régler le temps de cuisson seulement après avoir atteint la température désirée.

* Tourner les aliments à mi-cuisson

** Au besoin, retournez les aliments aux deux tiers de la cuisson).

*** Temps approximatif : les plats peuvent être retirés en tout temps, selon vos préférences personnelles.

Téléchargez le Guide d'utilisation et d'entretien sur www.hotpoint.eu pour obtenir le tableau de recettes testées, compilé pour les autorités de certification, conformément à la norme CEI 60350-1.

FONCTIONS								
	Traditionnel	Gril	Turbo Gril	Pizza	Chaleur pulsée	Cuisson grosse pièce	Pain Auto	Éco Chaleur pulsée
ACCESSOIRES								
	Grille métallique	Casserole ou plaque de cuisson sur la grille	Lèche-frite/plaque de cuisson sur grille métallique	LÈCHEFRITE	Lèche-frite contenant 200 ml d'eau	Plaque de cuisson		

NETTOYAGE ET ENTRETIEN



Pour plus d'information, téléchargez le Guide d'utilisation et entretien à partir de www.hotpoint.eu

N'utilisez pas d'appareil de nettoyage à vapeur.

Utilisez des gants de protection lors des opérations.

Effectuez les opérations nécessaires lorsque le four est froid.

Débranchez l'appareil de l'alimentation électrique.

N'utilisez pas de laine d'acier, de tampons à récurer abrasifs, ou des détergents abrasifs ou corrosifs, ils pourraient endommager les surfaces de l'appareil.

SURFACES EXTÉRIEURES

- Nettoyez les surfaces à l'aide d'un chiffon en microfibre humide. Si elles sont très sales, ajoutez quelques gouttes de détergent à pH neutre. Essuyez avec un chiffon sec.
- N'utilisez pas de détergents corrosifs ou abrasifs. Si l'un de ces produits entre en contact avec des surfaces de l'appareil, nettoyez immédiatement à l'aide d'un chiffon en microfibre humide.

SURFACES INTÉRIEURES

- Après chaque utilisation, laissez le four refroidir et nettoyez-le, de préférence lorsqu'il est encore tiède, pour enlever les dépôts ou taches laissés par les résidus de nourriture. Pour enlever la condensation qui se serait formée lors de la cuisson d'aliments avec une forte teneur en eau, laissez le four refroidir complètement et essuyez-le avec un chiffon ou une éponge.

- Utilisez la fonction « Diamond Clean » pour un meilleur nettoyage des surfaces internes.
- La porte peut facilement être enlevée et remplacée pour faciliter le nettoyage de la vitre .
- Nettoyez le verre dans la porte avec un détergent liquide approprié.
- L'élément chauffant supérieur du gril peut être baissé pour nettoyer la paroi supérieure du four .

ACCESSOIRES

Faites tremper les accessoires dans de l'eau contenant un détergent à vaisselle, utilisez des gants de cuisine s'ils sont encore chauds. Utilisez une brosse à vaisselle ou une éponge pour enlever les résidus d'aliments.

ENLEVER ET RÉINSTALLER LA PORTE

1. Pour enlever la porte, ouvrez-la complètement et abaissez les loquets jusqu'à ce qu'ils soient déverrouillés.

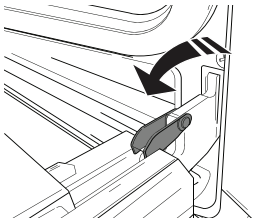

2. Fermez le plus possible la porte. Tenez la porte fermement avec les deux mains – ne la tenez pas par la poignée. Enlevez simplement la porte en continuant à la fermer tout en la tirant vers le haut (a) jusqu'à ce qu'elle soit dégagée de ses appuis (b).

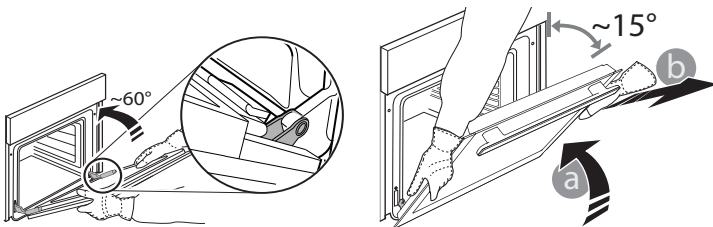

Placez la porte de côté, l'appuyant sur une surface souple.

3. Réinstallez la porte en la plaçant devant le four pour aligner les crochets des charnières avec leurs appuis, et insérez la partie supérieure sur son appui.

4. Abaissez la porte pour ensuite l'ouvrir complètement. Abaissez les loquets dans leur position originale : assurez-vous de les abaisser complètement.

5. Essayez de fermer la porte et assurez-vous qu'elle est alignée avec le panneau de commande. Sinon, répétez les étapes précédentes.

CLIQUER POUR NETTOYER - NETTOYER LA VITRE

1. Après avoir enlevée la porte et l'avoir placée sur une surface matelassée, les poignées vers le bas, appuyez sur les deux fermetures en même temps et enlevez le bord supérieur de la porte en la tirant vers vous.

2. Soulevez et tenez fermement la vitre intérieure avec les deux mains, enlevez-la et placez-la sur une surface matelassée avant de la nettoyer.

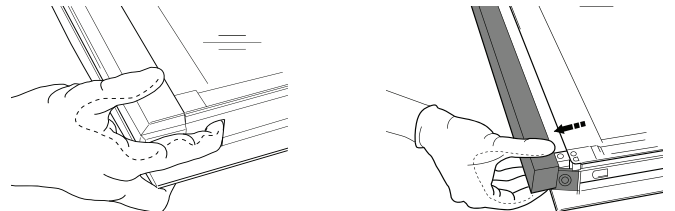

3. Pour bien replacer la vitre intérieure, assurez-vous que le « R » est visible dans le coin gauche et que la surface claire (pas d'imprimée) est placée vers le haut. En premier, insérez la longue partie de la vitre marquée d'un « R » dans les appuis des guides, abaissez-la ensuite en place.

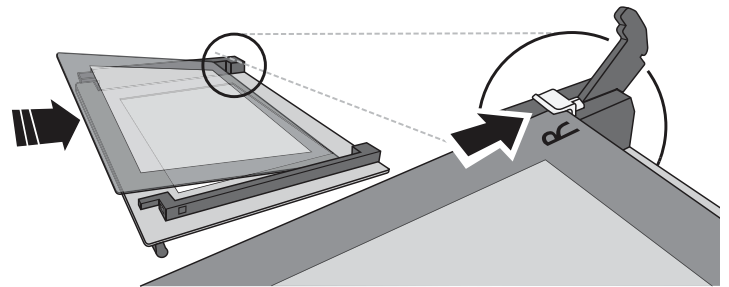

4. Remplacez le bord supérieur : un cliquet indique qu'elle est bien placée. Assurez-vous que le joint est bien placé avant de replacer la porte.

Problème	Cause possible	Solution
Le four ne fonctionne pas	Coupure de courant Débranchez de l'alimentation principale	Assurez-vous qu'il n'y a pas de panne de courant et que le four est bien branché. Éteignez puis rallumez le four pour voir si le problème persiste
L'écran affiche la lettre « F » suivi d'un numéro	Problème de logiciel	Prenez en note la lettre ou le numéro qui suit la lettre « F » et contactez le Service Après-vente le plus près
L'écran indique un texte difficile à lire et semble cassé.	Une autre langue est paramétrée.	Contactez votre Centre de service après-vente le plus proche.

CONSEILS UTILES



Pour plus d'information, téléchargez le Guide d'utilisation et entretien à partir de www.hotpoint.eu

COMMENT LIRE LE TABLEAU DE CUISSON

Le tableau indique la meilleure fonction, les accessoires, et le niveau à utiliser pour la cuisson des différents types d'aliments. Les temps de cuisson commencent au moment de l'introduction du plat dans le four et ne tiennent pas compte du préchauffage (si nécessaire). Les températures et temps de cuisson sont approximatifs et dépendent de la quantité d'aliments et du type d'accessoire. Pour commencer, utilisez les valeurs conseillées les plus basses, et si les aliments ne sont pas assez cuits, augmentez-les. Utilisez les accessoires fournis, et de préférence des moules à gâteau en métal foncés et des plats de cuisson. Vous pouvez aussi utiliser des plaques et accessoires en pyrex ou en céramique; cependant, les temps de cuisson seront sensiblement plus longs.

FONCTION PAIN AUTO

Pour les meilleurs résultats, suivez minutieusement les consignes en utilisant la recette pour mélanger 1000 g de pâte : 600 g de farine, 360 g d'eau, 11 g de sel, 25 g de levure fraîche (ou deux paquets de levure en poudre).

Pour la meilleure fermentation, laissez environ 90 minutes à la température de la pièce ou 60 minutes dans le four en utilisant la fonction « Levage ».

Placez la pâte dans le four froid, versez 100 cc d'eau potable froide dans le fond du four et lancez la fonction « Pain Auto ». Après la cuisson, laissez la pâte sur la grille métallique jusqu'à ce qu'elle soit complètement refroidie.

CUISSON D'ALIMENTS DIFFÉRENTS EN MÊME TEMPS

La fonction « Chaleur pulsée » permet de cuire en même temps plusieurs aliments nécessitant la même température de cuisson (comme le poisson et les légumes) sur différentes grilles. Enlevez les aliments qui demandent moins de cuisson et laissez dans le four les aliments qui ont besoin de plus de cuisson.

FICHE TECHNIQUE

La fiche technique, incluant les taux d'efficacité énergétique du four, peuvent être téléchargées sur notre site Web www.hotpoint.eu

COMMENT OBTENIR LE GUIDE D'UTILISATION ET ENTRETIEN

> Téléchargez le Guide d'utilisation et entretien sur notre site Web www.hotpoint.eu (vous pouvez utiliser ce code QR), en précisant le code commercial du produit.



> Une autre façon est de contacter notre Service Après-vente

CONTACTER LE SERVICE APRÈS-VENTE

Vous pouvez trouver les informations pour nous contacter dans le livret de garantie. Lorsque vous contactez notre Service Après-vente, veuillez indiquer les codes disponibles sur la plaque signalétique de l'appareil.

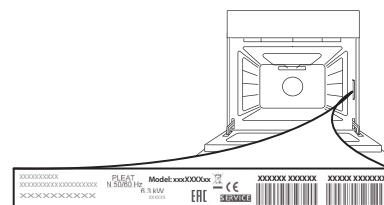

400011597418

Imprimé en Italie

GUIDA RAPIDA



GRAZIE PER AVER ACQUISTATO UN PRODOTTO HOTPOINT - ARISTON

Per ricevere un'assistenza più completa, registrare il prodotto su www.hotpoint.eu/register



Scaricare le istruzioni per la sicurezza e le istruzioni per l'uso collegandosi al sito www.hotpoint.eu e seguire la procedura indicata sul retro.



Leggere attentamente le istruzioni per la sicurezza prima di utilizzare il prodotto

DESCRIZIONE PRODOTTO

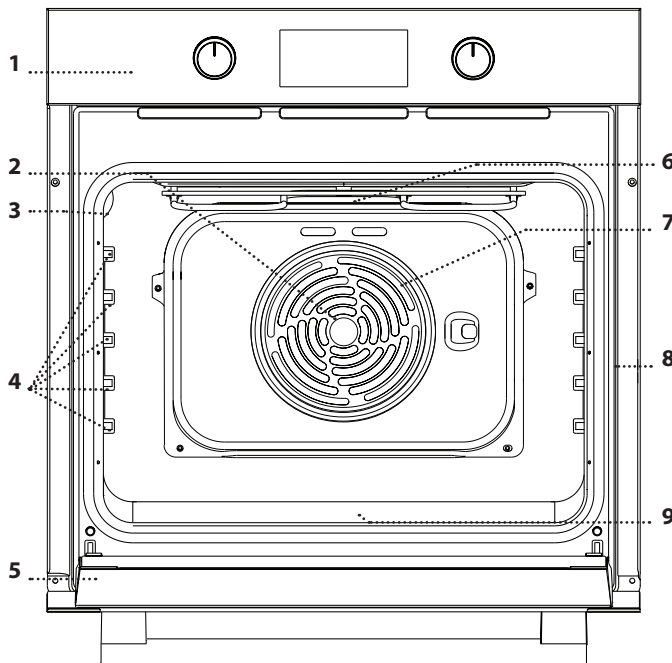

1. Pannello di controllo
2. Ventola
3. Lampada
4. Griglie laterali
(il livello è indicato sulla parete della cavità)
5. Porta
6. Resistenza superiore / grill
7. Resistenza circolare
(non visibile)
8. Targhetta matricola
(da non rimuovere)
9. Resistenza inferiore
(non visibile)

PANNELLO DI CONTROLLO

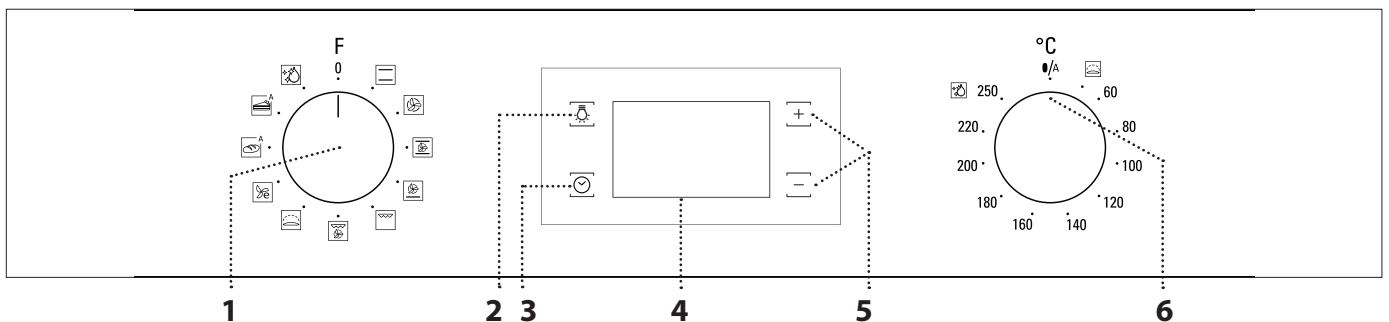

1. MANOPOLA DI SELEZIONE

Per accendere il forno selezionando una funzione. Per spegnere il forno, ruotare sulla posizione 0.

2. LUCE

A forno acceso, premere per accendere o spegnere la luce di cavità del forno.

3. IMPOSTAZIONE DEL TEMPO

Per accedere alle impostazioni della durata di cottura, dell'avvio ritardato e del timer. A forno spento, per visualizzare l'ora.

4. DISPLAY

5. TASTI DI REGOLAZIONE

Per modificare le impostazioni di durata.

6. MANOPOLA TERMOSTATO

Ruotare per selezionare la temperatura desiderata attivando le funzioni manuali. Uso delle funzioni automatiche \bullet/A .

Hotpoint

ARISTON

GRIGLIA

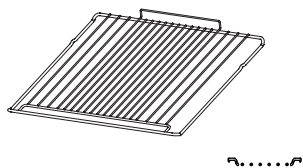

LECCARDA

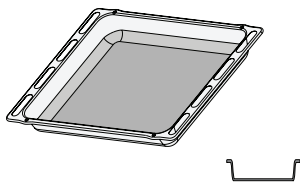

PIASTRA DOLCI

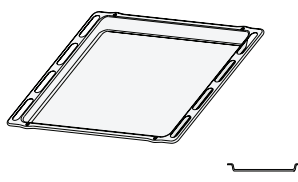

Il numero di accessori può variare a seconda del modello acquistato.
È possibile acquistare separatamente altri accessori presso il Servizio Assistenza Clienti.

INSERIRE LA GRIGLIA E ALTRI ACCESSORI

• Inserire la griglia tenendola leggermente inclinata verso l'alto, appoggiando dapprima il lato posteriore rialzato - orientato verso l'alto - sul livello desiderato. In seguito, farla scivolare orizzontalmente sulla griglia laterale fino a fine corsa.

• Gli altri accessori, come leccarda o piastra dolci si inseriscono orizzontalmente facendoli scivolare sulle griglie laterali.

FUNZIONI

STATICO*

Per cuocere qualsiasi tipo di pietanza su un solo ripiano.

TERMOVENTILATO

Per cuocere contemporaneamente su più ripiani (massimo tre) alimenti, anche diversi, che richiedono medesima temperatura di cottura. La funzione permette di cuocere senza trasmissione di odori da un alimento all'altro.

MAXI COOKING

Per cuocere carni di grosse dimensioni (superiori ai 2,5 kg). Si raccomanda di girare la carne durante la cottura per farla rosolare su tutti i lati. Si consiglia inoltre di irrorare la carne di tanto in tanto per evitare che asciughi eccessivamente.

PIZZA

Per cuocere diversi tipi e formati di pizza e focaccia. Si consiglia di invertire la posizione delle teglie a metà cottura.

GRILL

Per grigliare costate, spiedini e salsicce, gratinare verdure o dorare il pane. Per la grigliatura delle carni, si consiglia di utilizzare una leccarda per raccogliere il liquido di cottura: posizionarla a un livello sotto la griglia e aggiungere 200 ml di acqua potabile.

TURBO GRILL

Per arrostiti grossi pezzi di carne (cosciotti, roast beef, polli). Si consiglia di utilizzare una leccarda per raccogliere il liquido di cottura: posizionarla a un livello sotto la griglia e aggiungere 200 ml di acqua potabile.

LIEVITAZIONE

Per ottenere una lievitazione ottimale di impasti dolci o salati. Per preservare la qualità della lievitazione, non attivare la funzione se il forno è ancora caldo dopo un ciclo di cottura.

ECO TERMOVENTILATO*

Per cuocere arrostiti e arrostiti ripieni su uno stesso ripiano. La circolazione intermittente dell'aria impedisce un'eccessiva asciugatura degli alimenti. In questa funzione ECO la luce rimane spenta durante la cottura e può essere riaccesa premendo .

^A PANE AUTO

Questa funzione seleziona automaticamente temperatura e tempo ideali per la cottura del pane. Per ottenere i migliori risultati seguire attentamente la ricetta . Attivare la funzione a forno freddo.

^A DOLCI AUTO

Questa funzione seleziona automaticamente temperatura e tempo ideali per la cottura dei dolci. Attivare la funzione a forno freddo.



DIAMOND CLEAN

L'azione del vapore rilasciato durante questo speciale ciclo di pulizia a bassa temperatura permette di rimuovere facilmente sporco e residui di cibo. Versare 200ml di acqua potabile sul fondo del forno, attivando la funzione a forno freddo.







* Funzione di riferimento per la dichiarazione di efficienza energetica in accordo con il Regolamento europeo 65/2014

PRIMO UTILIZZO

1. IMPOSTARE L'ORA

Alla prima accensione, è necessario impostare l'ora: premere  fino a che sul display non lampeggiano l'icona  e le due cifre relative all'ora.



Utilizzare  o  per impostare l'ora e premere  per confermare. Sul display lampeggiano le due cifre relative ai minuti: utilizzare  o  per impostare l'ora e premere  per confermare.

Note: quando l'icona  lampeggia, ad esempio dopo una prolungata interruzione di corrente, è necessario impostare l'ora.

2. RISCALDARE IL FORNO

Un nuovo forno può rilasciare degli odori dovuti alla lavorazione di fabbrica: questo è normale. Prima di cucinare gli alimenti è dunque raccomandato di riscaldare a vuoto il forno per rimuovere ogni odore.

Rimuovere protezioni di cartone o pellicole trasparenti e togliere gli accessori dal forno.

Scaldare il forno a 250 °C per un'ora, utilizzando preferibilmente la funzione "Maxi cooking". Durante questa procedura il forno deve essere vuoto. Seguire le istruzioni a seguire per impostare correttamente la funzione.

Nota: è opportuno ventilare la stanza durante e dopo il primo utilizzo.

USO QUOTIDIANO

1. SELEZIONARE UNA FUNZIONE

Per selezionare una funzione, ruotare la *manopola di selezione* in corrispondenza del simbolo della funzione desiderata: il display si accende e il forno emette un segnale acustico.



2. AVVIARE UNA FUNZIONE

MANUALE

Per avviare la funzione selezionata, ruotare la *manopola termostato* per impostare la temperatura desiderata.



Note: durante la cottura sarà possibile modificare la funzione ruotando la *manopola di selezione* o regolare la temperatura ruotando la *manopola termostato*.

La funzione non si avvierà fino a quando la manopola termostato sarà su 0°C. Sarà possibile impostare durata, ora di fine cottura (solo se è impostata una durata) e timer.

AUTOMATICO

Per avviare la funzione automatica ("Pane" o "Dolci") selezionata, mantenere la *manopola termostato* sulla posizione dedicata alle funzioni automatiche (0/A). Per terminare la cottura, ruotare la *manopola di selezione* in corrispondenza della posizione 0.



Note: sarà possibile impostare ora di fine cottura e timer.

LIEVITAZIONE

Per avviare la funzione "Lievitazione", ruotare la *manopola termostato* in corrispondenza del simbolo della funzione; se in corrispondenza di temperature differenti, la funzione non si avvierà

Note: sarà possibile impostare durata, ora di fine cottura (solo se è impostata una durata) e timer.

3. PRERISCALDAMENTO

Una volta avviata la funzione, un segnale acustico e l'icona  lampeggiante sul display segnalano che si è attivata la fase di preriscaldamento. Al termine di questa fase, un segnale acustico e l'icona  fissa sul display indicheranno che il forno ha raggiunto la temperatura impostata: a questo punto, inserire gli alimenti e procedere alla cottura.

Note: inserire gli alimenti nel forno prima della fine del preriscaldamento può compromettere i risultati di cottura.



. PROGRAMMARE LA COTTURA



Per programmare la cottura è necessario aver selezionato precedentemente una funzione.

DURATA



Premere  tante volte fino a che sul display lampeggiano l'icona  e "00:00".





Utilizzare  o  per impostare la durata desiderata, quindi premere  per confermare. Attivare la funzione ruotando la *manopola termostato* in corrispondenza della temperatura desiderata o necessaria: un segnale acustico e il display avviseranno del termine della cottura.

Note: per annullare la durata impostata, premere  tante volte fino a che sul display lampeggia l'icona , quindi utilizzare  per riportare la durata a "00:00". La durata impostata include la fase di preriscaldamento.

PROGRAMMARE L'ORA DI FINE COTTURA / AVVIO RITARDATO

Una volta impostata una durata sarà possibile posticipare l'avvio della funzione, programmandone l'ora di fine: premere  fino a che sul display non lampeggiano l'icona  e l'ora corrente.



Utilizzare  o  per impostare l'ora di fine cottura desiderata e premere  per confermare. Attivare la funzione ruotando la *manopola termostato* in corrispondenza della temperatura desiderata o necessaria: la funzione resterà in pausa fino ad avviarsi automaticamente dopo un periodo di tempo calcolato per terminare la cottura all'orario impostato.



Note: per annullare l'impostazione, spegnere il forno ruotando la **manopola di selezione** sulla posizione "0".

Il ritardo di avvio della funzionalità non è disponibile per le funzioni Grill e Turbo Grill.

FINE COTTURA

Un segnale acustico e il display avvertono del termine della funzione.

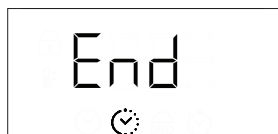

Ruotare la *manopola di selezione* per selezionare una funzione differente o sulla posizione "0" per spegnere il forno.



Nota: se attivo il timer, il display mostrerà la scritta "END" in alternanza al tempo rimanente.



. IMPOSTARE IL TIMER

Questa opzione non interrompe né programma la cottura ma permette di utilizzare il display come contaminuti, sia durante una funzione attiva che quando il forno è spento.

Premere  tante volte fino a che sul display lampeggiano l'icona  e "00:00".



Utilizzare  o  per impostare la durata desiderata e premere  per confermare. Un segnale acustico avviserà del termine del conto alla rovescia.

Note: per disattivare il timer, premere  tante volte fino a che l'icona  lampeggia, quindi utilizzare  per riportare la durata a "00:00".

. FUNZIONE DIAMOND CLEAN

Per attivare la funzione di pulizia "Diamond clean", dopo aver versato 200 ml di acqua potabile sul fondo della cavità del forno, ruotare la *manopola di selezione* e la *manopola termostato* in corrispondenza dell'icona .



































































Nota: la posizione dell'icona non corrisponde alla temperatura raggiunta durante il ciclo di pulizia.

La funzione si attiva automaticamente: il display mostra il tempo rimanente al termine, alternato alla scritta "dc".









Note: sarà possibile programmare solo l'ora di fine della funzione. La durata è automaticamente impostata a 35 minuti.

TABELLA DI COTTURA

RICETTA	FUNZIONE	PRE RISCALDARE	TEMPERATURA (°C)	DURATA (MIN)	LIVELLO E ACCESSORI
Torte a lievitazione		Sì	160 - 180	30 - 90	2/3 
		Sì	160 - 180	30 - 90	4  1 
Torte ripiene (cheesecake, strudel, torta di frutta)		Sì	160 - 200	35 - 90	2 
		Sì	160 - 200	40 - 90	4  2 
Biscotti/Tortine		Sì	160 - 180	20 - 45	3 
		Sì	150 - 170	20 - 45	4  2 
		Sì	150 - 170	20 - 45	5  3  1 
Bigné		Sì	180 - 210	30 - 40	3 
		Sì	180 - 200	35 - 45	4  2 
		Sì	180 - 200	35 - 45	5  3  1 
Meringhe		Sì	90	150 - 200	3 
		Sì	90	140 - 200	4  2 
		Sì	90	140 - 200	5  3  1 
Pizza / Focaccia		Sì	190 - 250	15 - 50	1/2 
		Sì	190 - 250	20 - 50	4  2 
Pane		-	-	60	2 
Pizze surgelate		Sì	250	10 - 20	3 
		Sì	230 - 250	10 - 25	4  2 
Torte salate (torta di verdura, quiche)		Sì	180 - 200	40 - 55	3 
		Sì	180 - 200	45 - 60	4  2 
		Sì	180 - 200	45 - 60	5  3  1 
Voulevant / Salatini di pasta sfoglia		-	190 - 200	20 - 30	3 
		-	180 - 190	20 - 40	4  2 
		-	180 - 190	20 - 40	5  3  1 

FUNZIONI								
	Statico	Grill	Turbo Grill	Pizza	Termoventilato	Maxi Cooking	Pane Auto	Eco Termoventilato

ACCESSORI						
	Griglia	Tortiera o teglia su griglia	Leccarda / Teglia su griglia	Leccarda	Leccarda con 200ml di acqua	Piastra Dolci

RICETTA	FUNZIONE	PRE RISCALDARE	TEMPERATURA (°C)	DURATA (MIN)	LIVELLO E ACCESSORI
Lasagna / Pasta al forno / Cannelloni / Sformati		Sì	190 - 200	45 - 65	2
Agnello / Vitello / Manzo / Maiale 1 Kg		Sì	190 - 200	80 - 110	3
Arrosto di maiale con cotenna 2kg		Sì	180 - 190	110 - 150	2
Pollo / Coniglio / Anatra 1 kg		Sì	200 - 230	50 - 100	2
Tacchino / Oca 3 kg		-	190 - 200	100 - 160	2
Pesce al forno / al cartoccio (filetto, intero)		Sì	170 - 190	30 - 50	2
Verdure ripiene (pomodori, zucchine, melanzane)		Sì	180 - 200	50 - 70	2
Pane tostato		-	250	2 - 6	5
Filetti / tranci di pesce		-	230 - 250	20 - 30*	4 3
Salsicce / Spiedini / Costine / Hamburger		-	250	15 - 30*	5 4
Pollo arrosto 1-1,3 kg		Sì	200 - 220	55 - 70**	2 1
Roast beef al sangue 1 kg		Sì	200 - 210	35 - 50**	3
Cosciotto di agnello / Stinchi		Sì	200 - 210	60 - 90**	3
Patate arrosto		Sì	200 - 210	35 - 55**	3
Verdure gratinate		-	200 - 210	25 - 55	3
Carne & Patate		Sì	190 - 200	45 - 100***	4 1
Pesce & Verdure		Sì	180	30 - 50***	4 1
Lasagna & Carne		Sì	200	50 - 100***	4 1
Pasto completo: Crostata (Liv. 5) / Lasagna (Liv. 3) / Carne (Liv. 1)		Sì	180 - 190	40 - 120***	5 3 1
Arrosti / Arrosti ripieni		-	170 - 180	100 - 150	2

La durata indicata non comprende la fase di preriscaldamento: si consiglia di inserire gli alimenti nel forno e di impostare la durata della cottura solo al raggiungimento della temperatura desiderata.

* Ruotare il cibo a metà cottura

** Ruotare il cibo a due terzi di cottura se necessario.

*** La durata è approssimata: le pietanze possono essere tolte dal forno in tempi differenti secondo preferenza.

Scaricare le Istruzioni per l'uso collegandosi al sito www.hotpoint.eu per consultare la tabella delle ricette testate, compilata per gli istituti di valutazione secondo la norma IEC 60350-1.

FUNZIONI								
	Statico	Grill	Turbo Grill	Pizza	Termovenilato	Maxi Cooking	Pane Auto	Eco Termovenilato
ACCESSORI								
	Griglia	Tortiera o teglia su griglia	Leccarda / Teglia su griglia	Leccarda	Leccarda con 200ml di acqua	Piastra Dolci		

CURA E PULIZIA



Scaricare le istruzioni per l'uso da
www.hotpoint.eu per maggiori informazioni

Non usare pulitrici a getto di vapore.

Utilizzare guanti protettivi durante tutte le operazioni.

Eseguire le operazioni indicate a forno freddo.

Scollegare l'apparecchio dalla rete elettrica.

Non usare pagliette metalliche, panni abrasivi e detersivi abrasivi o corrosivi che possano danneggiare le superfici.

SUPERFICI ESTERNE

- Pulire le superfici con un panno in microfibra umido. Se molto sporche, aggiungere qualche goccia di detersivo neutro. Asciugare con un panno asciutto.
- Non usare detersivi corrosivi o abrasivi. Se inavvertitamente uno di questi prodotti dovesse venire a contatto con le superfici, pulire subito con un panno in microfibra umido.

SUPERFICI INTERNE

- Dopo ogni uso, lasciare raffreddare il forno e pulirlo preferibilmente quando è ancora tiepido per rimuovere incrostazioni e macchie dovute a residui di cibo; per asciugare la condensa dovuta alla cottura di alimenti con un elevato contenuto di acqua, usare a forno freddo un panno o una spugna.

- Attivare la funzione "Diamond Clean" per una pulizia ottimale delle superfici interne.
- Per facilitare la pulizia dei vetri è possibile rimuovere e smontare facilmente la porta.
- Pulire i vetri della porta con detersivi liquidi specifici.
- La resistenza superiore del grill può essere abbassata per pulire la parete superiore del forno.

ACCESSORI

Mettere a bagno gli accessori con detersivo per piatti dopo l'uso, maneggiandoli con guanti da forno, se ancora caldi. I residui di cibo possono essere rimossi con una spazzola per piatti o con una spugna.

TOGLIERE E RIMONTARE LA PORTA

1. Per rimuovere la porta, aprirla completamente e abbassare i fermi fino alla posizione di sblocco.

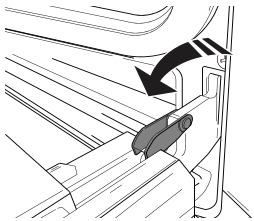

2. Chiudere la porta fino a quando è possibile. Prendere saldamente la porta con entrambe le mani, evitando di tenerla per la maniglia. Per estrarla facilmente, continuare a chiuderla e contemporaneamente tirarla verso l'alto (a) finché non esce dalle sedi (b).

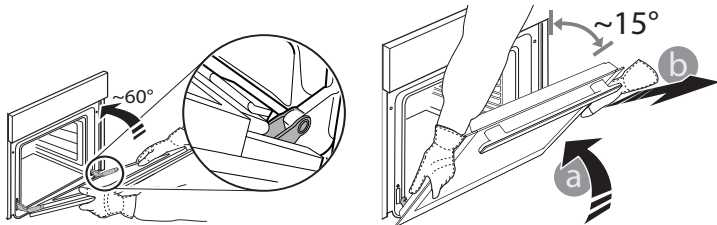

Togliere la porta e appoggiarla su un piano morbido.

3. Per rimontare la porta, avvicinarla al forno allineando i ganci delle cerniere alle proprie sedi e ancorare la parte superiore agli alloggiamenti.

4. Abbassare la porta e poi aprirla completamente. Abbassare i fermi nella posizione originale: fare attenzione che siano completamente abbassati.

5. Provare a chiudere la porta, verificando che sia allineata al pannello di controllo. Se non lo fosse, ripetere tutte le operazioni.

CLICK TO CLEAN - PULIRE IL VETRO

1. Dopo aver smontato la porta e averla appoggiata su un ripiano morbido con la maniglia verso il basso, premere contemporaneamente le due clip di fissaggio ed estrarre il profilo superiore della porta tirandolo verso di sé.

2. Sollevare e prendere saldamente il vetro interno con due mani, rimuoverlo e appoggiarlo su un piano morbido prima di eseguire la pulizia.

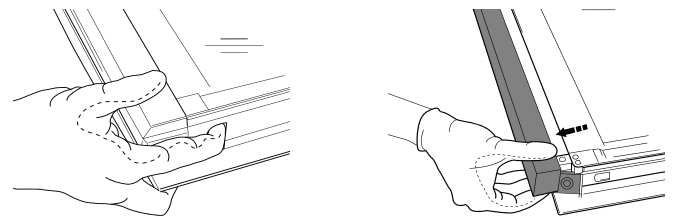

3. Per riposizionare correttamente il vetro interno, fare attenzione che la "R" sia leggibile nell'angolo destro e che la superficie lucida (non stampata) sia rivolta verso l'alto. Inserire dapprima il lato lungo del vetro indicato dalla "R" nelle sedi di sostegno, quindi abbassarlo in posizione.

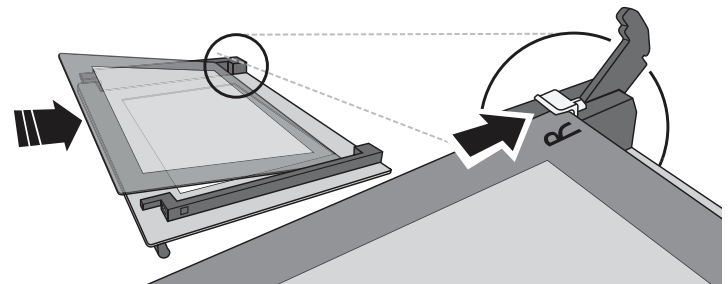

4. Rimontare il profilo superiore: un clic indica il corretto posizionamento. Verificare che la tenuta sia salda prima di rimontare la porta.

RISOLUZIONE DEI PROBLEMI



Scaricare le istruzioni per l'uso da
www.hotpoint.eu per maggiori informazioni

Problema	Possibile causa	Soluzione
Il forno non funziona	Interruzione di corrente elettrica Disconnessione dalla rete principale	Verificare che ci sia tensione in rete e che il forno sia collegato all'alimentazione elettrica. Spegnerne e riaccendere il forno e verificare se l'inconveniente persiste
Il display mostra la lettera "F" seguita da un numero	Problema software	Contattare il più vicino Servizio Assistenza Clienti e specificare il numero che segue la lettera "F"
Il display visualizza un testo poco chiaro e sembra essere guasto.	Un'altra lingua impostata.	Contatta il Servizio Assistenza Tecnica più vicino.

CONSIGLI UTILI



Scaricare le istruzioni per l'uso da
www.hotpoint.eu per maggiori informazioni

COME LEGGERE LA TABELLA DI COTTURA

La tabella indica la funzione, gli accessori e il livello migliore da utilizzare per cuocere svariati tipi di cibo. I tempi di cottura si riferiscono all'introduzione del cibo nel forno, escluso il preriscaldamento (dove richiesto). Le temperature e i tempi di cottura sono indicativi e dipendono dalla quantità di cibo e dal tipo di accessori. Utilizzare inizialmente i valori più bassi consigliati e, se il risultato della cottura non è quello desiderato, passare a quelli più alti. Si consiglia di utilizzare gli accessori in dotazione e tortiere o teglie possibilmente in metallo scuro. È possibile utilizzare anche pentole e accessori in pyrex o in ceramica, i tempi di cottura si allungheranno leggermente.

CUCINARE DIFFERENTI ALIMENTI CONTEMPORANEAMENTE

Utilizzando la funzione "Termoventilato", è possibile cuocere contemporaneamente cibi diversi (ad esempio: pesce e verdure), su ripiani diversi. Estrarre i cibi che richiedono tempi di cottura inferiori e lasciare continuare la cottura per quelli con tempi più lunghi.

FUNZIONE PANE AUTO

Per ottenere i migliori risultati è opportuno seguire attentamente le indicazioni, rispettando la ricetta per 1000g d'impasto: 600g di farina, 360g di acqua, 11g di sale, 25g di lievito fresco (oppure 2 bustine di lievito in polvere).

Per una lievitazione ottimale, sono necessari circa 90 minuti a temperatura ambiente oppure 60 minuti all'interno del forno attivando la funzione "Lievitazione".

Infornare a forno freddo, versare 1 dl di acqua potabile fredda sul fondo del forno e avviare la funzione "Pane Auto". Al termine della cottura, lasciare riposare su una griglia fino a completo raffreddamento.

SCHEDA TECNICA

 La scheda tecnica del prodotto con i dati del consumo energetico è scaricabile dal sito web www.hotpoint.eu

COME OTTENERE LE ISTRUZIONI PER L'USO

>  Scaricare le Istruzioni per l'uso dal sito web www.hotpoint.eu (è possibile utilizzare questo codice QR) specificando il codice prodotto.



> In alternativa, contattare il Servizio di Assistenza Clienti

CONTATTARE IL SERVIZIO ASSISTENZA CLIENTI

I contatti possono essere trovati sul manuale di garanzia. Quando si contatta il Servizio di Assistenza Clienti fornire i codici presenti sulla targhetta matricola del prodotto.

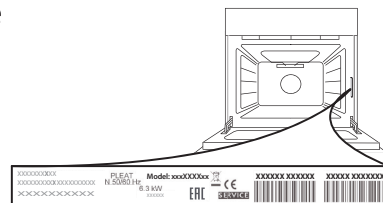

400011597418

Stampato in Italia



GUIA DE CONSULTA DIÁRIA



OBRIGADO POR ADQUIRIR UM PRODUTO HOTPOINT - ARISTON

Para receber mais informações e assistência, registre o seu produto em www.hotpoint.eu/register



Pode transferir as Instruções de Segurança e o Guia de Utilização e Manutenção visitando o nosso website www.hotpoint.eu e seguindo as instruções no verso do presente guia.



Antes de utilizar o produto, leia atentamente as instruções de segurança

DESCRIÇÃO DO PRODUTO

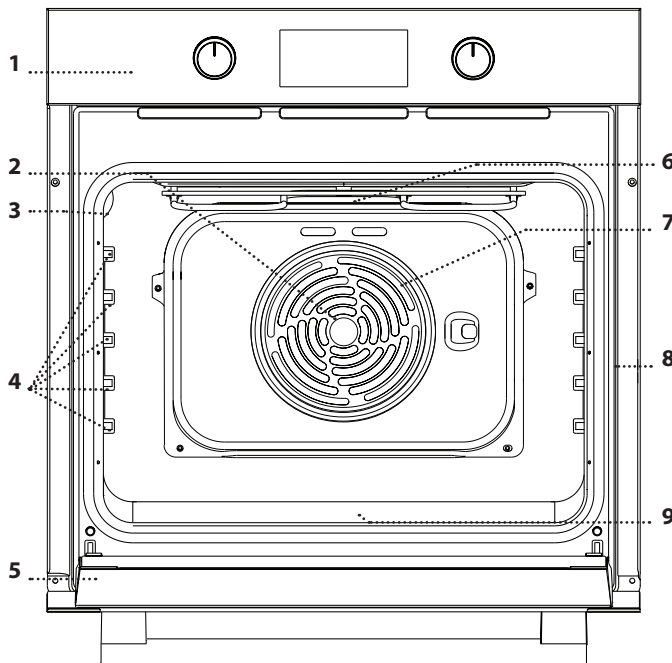

1. Painel de controlo
2. Ventoinha
3. Lâmpada
4. Guias de nível
(o nível está indicado na parede do compartimento de cozedura)
5. Porta
6. Resistência superior/grill
7. Resistência circular
(invisível)
8. Placa de identificação
(não remover)
9. Resistência inferior
(invisível)

PAINEL DE COMANDOS

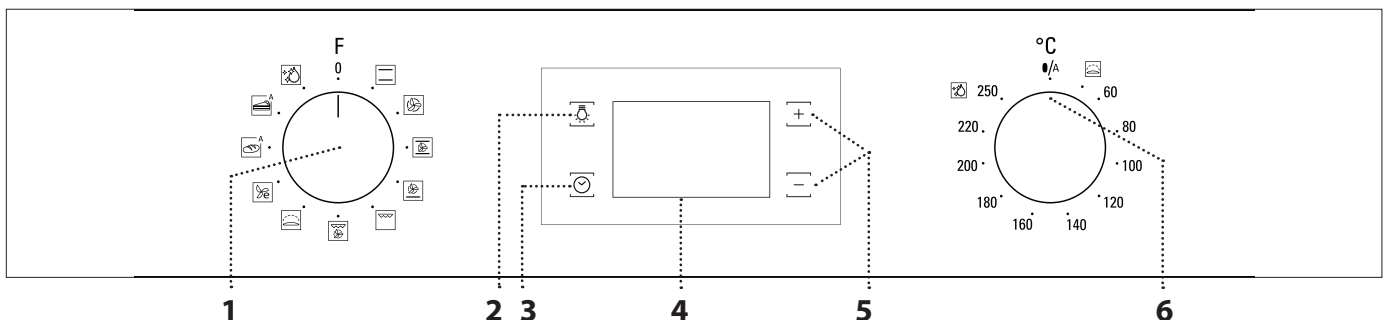

1. BOTÃO SELETOR

Para ligar o forno selecionando uma função.
Para desligar o forno, rode o botão para a posição 0.

2. LUZ

Com o forno ligado, prima o botão para desligar a lâmpada do compartimento do forno.

3. AJUSTE DA HORA

Para aceder às definições do tempo de cozedura, de início diferido e do temporizador. Para apresentar o tempo em que o forno está desligado.

4. VISOR

5. BOTÕES DE AJUSTE

Para aceder às definições do tempo de cozedura.

6. BOTÃO DO TERMÓSTATO

Rode o botão para selecionar a temperatura pretendida ao ativar as funções manuais. Utilização das funções automáticas 0/A.

GRELHA METÁLICA

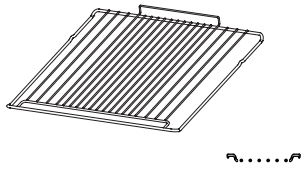

TABULEIRO COLETOR

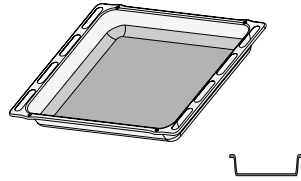

TABULEIRO PARA ASSAR

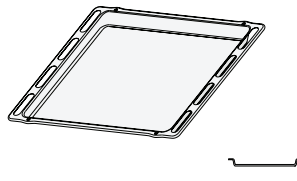

O número de acessórios pode variar de acordo com o modelo adquirido. Pode adquirir separadamente outros acessórios no Serviço Pós-venda.

INTRODUZIR GRELHAS E OUTROS ACESSÓRIOS

• Insira a grelha metálica no nível pretendido, segurando-a e inclinando-a ligeiramente para cima; em seguida, pouse a parte traseira levantada (apontando para cima) primeiro. Faça-a deslizar na horizontal pelas guias de nível tanto quanto possível.

• Outros acessórios, como o tabuleiro coletor e o tabuleiro para pastelaria devem ser introduzidos horizontalmente, fazendo-os deslizar pelas guias.

FUNÇÕES

CONVENCIONAL*

Para cozinhar qualquer tipo de alimento utilizando apenas um nível.

AR FORÇADO

Para cozinhar diferentes alimentos, que exijam a mesma temperatura de cozedura, em diferentes níveis (três, no máximo) e em simultâneo. Esta função permite cozinhar alimentos diferentes sem transmitir odores de uns alimentos para os outros.

MAXI COZEDURA

Para cozinhar pedaços grandes de carne (acima de 2,5 kg). Recomendamos que vire a carne durante a cozedura, para assegurar que fica uniformemente dourada de ambos os lados. Também recomendamos que regue a carne esporadicamente, para evitar que fique excessivamente seca.

PIZZA

Para cozinhar diferentes tipos e formatos de pão e pizza. Recomendamos que troque a posição dos tabuleiros de assar a meio do processo de cozedura.

GRILL

Para grelhar bifes, espetadas, salsichas, gratinar legumes ou tostar pão. Ao grelhar carne, recomendamos a utilização de um tabuleiro coletor, para recolher os sucos da cozedura: posicione o tabuleiro em qualquer um dos níveis que se encontram abaixo da grelha e adicione 200 ml de água potável.

TURBO GRILL

Para assar peças de carne grandes (pernil, rosbife, frango). Recomendamos a utilização de um tabuleiro coletor, para recolher os sucos da cozedura: posicione o tabuleiro em qualquer um dos níveis que se encontram abaixo da grelha e adicione 200 ml de água potável.

LEVEDURA

Para ajudar a uma levedação eficaz de massas doces ou salgadas. Para manter a qualidade da levedação, não ativar a função se o forno ainda estiver quente após um ciclo de cozedura.

AR FORÇADO ECO*

Para assar peças de carne/peças de carne recheadas num único nível. Evita-se que os alimentos sequem excessivamente, através de uma circulação de ar suave e intermitente. Quando esta função está a ser utilizada, a luz mantém-se apagada ao longo da cozedura, mas pode acender-se temporariamente, premindo .

PÃO AUTO

Esta função seleciona automaticamente a temperatura ideal e o tempo de cozedura para pães. Para obter os melhores resultados possíveis, siga cuidadosamente a receita . Ative esta função apenas quando o forno estiver frio.

PASTELARIA AUTO

Esta função seleciona automaticamente a temperatura ideal e o tempo de cozedura para bolos. Ative esta função apenas quando o forno estiver frio.



DIAMOND CLEAN

A ação do vapor libertado durante este ciclo de limpeza a baixa temperatura especial permite a fácil remoção de resíduos de sujidade de comida. Verta 200 ml de água na parte inferior da cavidade e ative a função quando o forno estiver frio.







* Função utilizada como referência para a declaração de eficiência energética, de acordo com o Regulamento (UE) n.º 65/2014

PRIMEIRA UTILIZAÇÃO DO APARELHO

1. AJUSTE DA HORA

Ao ligar o aparelho pela primeira vez, terá de definir a hora: prima  até que o ícone  e os dois dígitos da hora comecem a piscar no visor.



Utilize  ou  para acertar a hora e prima  para confirmar. Os dois dígitos dos minutos começam a piscar. Utilize  ou  para definir os minutos e prima  para confirmar.

Lembre-se: Quando o ícone  está a piscar, por exemplo, durante cortes de energia prolongados, é necessário acertar a hora.

2. AQUECER O FORNO

Um forno novo pode libertar odores residuais, resultantes do processo de fabrico: isto é perfeitamente normal.

Assim, antes de começar a cozinhar alimentos, recomendamos que aqueça o forno, vazio, para eliminar eventuais odores.

Remova do forno qualquer elemento de proteção em cartão ou película transparente e retire quaisquer acessórios do respetivo interior.

Aqueça o forno a 250 °C durante cerca de uma hora, utilizando preferencialmente a função "Maxi Cozedura". O forno deve estar vazio durante o aquecimento.

Siga as instruções para programar corretamente a função.

Lembre-se: É aconselhável arejar a cozinha após a primeira utilização do aparelho.

UTILIZAÇÃO DIÁRIA

1. SELECIONAR UMA FUNÇÃO

Para selecionar uma função, rode o *botão seletor* para o símbolo da função que pretende selecionar: o visor acende-se e ouve-se um sinal sonoro.



2. ATIVAR UMA FUNÇÃO

MANUAL

Para iniciar a função selecionada, rode o *botão do termóstato* para definir a temperatura requerida.



Lembre-se: Durante a cozedura é possível e alterar a função rodando o *botão seletor* ou regular a temperatura rodando o *botão do termóstato*.

A função não pode ser iniciada se o botão do termóstato estiver na posição 0 °C. Pode definir o tempo de cozedura, o tempo de fim da cozedura (apenas se selecionar um tempo de cozedura) e um temporizador.

AUTOMÁTICO

Para iniciar a função automática selecionada ("Pão" ou "Pastelaria"), mantenha o *botão do termóstato* na posição correspondente às funções automáticas (0/A). Para terminar a cozedura, rode o *botão seletor* para a posição 0.

Lembre-se: Pode definir o tempo de cozedura e o temporizador.

LEVEDURA

Para dar início à função "Levedação", rode o *botão do termóstato* até ao ícone relevante; Se o forno tiver

uma temperatura diferente definida, a função não será iniciada.

Lembre-se: Pode definir o tempo de cozedura, o tempo de fim da cozedura (apenas se selecionar um tempo de cozedura) e um temporizador.

3. PRÉ-AQUECIMENTO

Uma vez iniciada a função, é emitido um sinal sonoro e o ícone  a piscar no visor indica que a fase de pré-aquecimento foi ativada.



Terminada a fase de pré-aquecimento, é emitido um sinal sonoro e o ícone  fixo no visor indicam que o forno atingiu a temperatura definida: nessa altura, coloque os alimentos no interior do forno e dê início à cozedura.

Lembre-se: Colocar os alimentos no forno antes de o pré-aquecimento estar concluído, pode ter um efeito adverso no resultado final da cozedura.



. PROGRAMAR A COZEDURA



É necessário selecionar uma função antes de programar a cozedura.

DURAÇÃO

Mantenha o ícone  premido até que o ícone  e a indicação "00:00" comecem a piscar no visor.





Utilize  ou  para definir o tempo de cozedura pretendido e, em seguida, prima  para confirmar. Ative a função rodando o *botão do termóstato* para a temperatura requerida: é emitido um sinal sonoro e o visor indica que a cozedura está concluída.



Notas: Para cancelar o tempo de cozedura definido, mantenha premido o botão  até que o ícone  comecem a piscar no visor e, em seguida, prima  para repor o tempo de cozedura para "00:00".

Este tempo de cozedura inclui uma fase de pré-aquecimento.

PROGRAMAR O TEMPO DE FIM/INÍCIO DIFERIDO DA COZEDURA

Após definir um tempo de cozedura, o início da função pode ser diferido, programando o tempo de fim: prima  até que o ícone  e a hora atual comecem a piscar no visor.



Utilize  ou  para definir o tempo de fim da cozedura pretendido e, em seguida, prima  para confirmar.

Ative a função rodando o *botão do termóstato* para a temperatura requerida: a função irá permanecer em pausa até ser iniciada automaticamente após o período de tempo calculado para concluir a cozedura à hora programada.

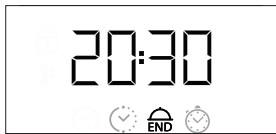

Notas: Para cancelar a definição, desligue o forno rodando o *botão seletor* para a posição "0".

A funcionalidade de atraso de arranque não está disponível para as funções Grill e Turbo Grill.

FIM DA COZEDURA

É emitido um sinal sonoro e o visor indica que a função está concluída.





Rode o *botão seletor* para selecionar uma outra função ou para a posição "0" para desligar o forno.



Lembre-se: Caso o temporizador esteja ativado, o visor indica a mensagem "END" (FIM) alternada com o tempo restante.



PROGRAMAR O TEMPORIZADOR

Esta opção não interrompe, nem programa a cozedura mas permite-lhe utilizar o visor como temporizador, quer enquanto uma função está ativada, quer quando o forno está desligado.

Mantenha o ícone  premido até que o ícone  e a indicação "00:00" comecem a piscar no visor.



Utilize  ou  para definir o tempo pretendido e prima  para confirmar. Quando o temporizador terminar a contagem decrescente do tempo programado, ouvir-se-á um sinal sonoro.

Notas: Para cancelar o temporizador, mantenha premido o botão  até que o ícone  comecem a piscar e, em seguida, utilize  para repor o tempo para "00:00".

. FUNÇÃO DIAMOND CLEAN

Para ativar a função "Diamond Clean", verta 200 ml de água potável no fundo do forno e, em seguida, rode o *botão seletor* e o *botão do termóstato* para o ícone .



































































Lembre-se: A posição do ícone não corresponde à temperatura atingida durante o ciclo de limpeza.

A função é ativada automaticamente: o visor apresenta o tempo restante até ao final da cozedura alternado com a mensagem "DC".









Lembre-se: É possível programar o tempo de fim desta função. A duração está pré-definida automaticamente para 35 minutos.

TABELA DE COZEDURA

RECEITA	FUNÇÃO	PRÉ-AQUECIM.	TEMPERATURA (°C)	DURAÇÃO (MIN.)	NÍVEL E ACESSÓRIOS
Bolos com levedura		Sim	160-180	30-90	2/3 
		Sim	160-180	30-90	4 1  
Bolo recheado (cheesecake, strudel, tarte de frutas)		Sim	160-200	35-90	2 
		Sim	160-200	40-90	4 2  
Biscoitos/queques		Sim	160-180	20-45	3 
		Sim	150 - 170	20-45	4 2  
		Sim	150 - 170	20-45	5 3 1   
Massa choux		Sim	180 - 210	30-40	3 
		Sim	180-200	35-45	4 2  
		Sim	180-200	35-45	5 3 1   
Merengues		Sim	90	150 - 200	3 
		Sim	90	140 - 200	4 2  
		Sim	90	140 - 200	5 3 1   
Pizza/Pão		Sim	190-250	15-50	1 / 2 
		Sim	190-250	20-50	4 2  
Pão		-	-	60	2 
Pizza congelada		Sim	250	10 - 20	3 
		Sim	230 - 250	10 -25	4 2  
Bolos salgados (tarte de legumes, quiche)		Sim	180-200	40-55	3 
		Sim	180-200	45 - 60	4 2  
		Sim	180-200	45 - 60	5 3 1   
Vol-au-vents/salgadinhos de massa folhada		-	190-200	20-30	3 
		-	180-190	20-40	4 2  
		-	180-190	20-40	5 3 1   

FUNÇÕES								
	Convencional	Grill	Turbo Grill	Pizza	Ar forçado	Maxi Cozedura	Pão Auto	Ar forçado Eco

ACESSÓRIOS						
	Grelha	Prato ou tabuleiro para assar na grelha metálica	Tabuleiro coletor/tabuleiro para assar ou grelha	Tabuleiro coletor	Tabuleiro coletor com 200 ml de água	Tabuleiro para pastelaria

RECEITA	FUNÇÃO	PRÉ-AQUECIM.	TEMPERATURA (°C)	DURAÇÃO (MIN.)	NÍVEL E ACESSÓRIOS
Lasanha/massa ao forno/ canelones/ flans		Sim	190-200	45-65	2
Borrego/vitela/vaca/porco 1 kg		Sim	190-200	80-110	3
Porco assado estaladiço 2 kg		Sim	180-190	110-150	2
Frango/coelho/pato 1 kg		Sim	200-230	50-100	2
Peru/ganso 3 kg		-	190 - 200	100 - 160	2
Peixe no forno/em papelote (filete, inteiro)		Sim	170 - 190	30 - 50	2
Legumes recheados (tomates, curgetes, beringelas)		Sim	180-200	50 - 70	2
Pão tostado		-	250	2 - 6	5
Filetes/postas de peixe		-	230 - 250	20 - 30*	4 3
Salsichas/espetadas/costeletas/hambúrgueres		-	250	15 - 30*	5 4
Frango assado 1-1,3 kg		Sim	200 - 220	55 - 70**	2 1
Rosbife mal passado 1 kg		Sim	200 - 210	35 - 50**	3
Perna de borrego/pernis		Sim	200 - 210	60 - 90**	3
Batatas assadas		Sim	200 - 210	35 - 55**	3
Gratinado legumes		-	200 - 210	25 - 55	3
Carne e batatas		Sim	190-200	45 - 100***	4 1
Peixe e legumes		Sim	180	30 - 50***	4 1
Lasanha e carne		Sim	200	50 - 100***	4 1
Refeição completa: tarte de frutas (nível 5)/lasanha (nível 3)/carne (nível 1)		Sim	180-190	40 - 120***	5 3 1
Carne assada/carne assada recheada		-	170 - 180	100 - 150	2

O tempo indicado não inclui a fase de pré-aquecimento: recomendamos que coloque os alimentos no forno e defina o tempo de cozedura apenas após o mesmo ter alcançado a temperatura requerida.

* Vire o alimento a meio da cozedura

** Vire o alimento quando atingir dois terços do tempo de cozedura (se necessário).

*** Período de tempo estimado: Os alimentos podem ser retirados do forno quando o desejar, dependendo da preferência de cada um.

Transfira o Guia de Utilização e Manutenção em www.hotpoint.eu para consultar a tabela de receitas testadas, compiladas para as autoridades de certificação de acordo com a norma IEC 60350-1.

FUNÇÕES								
	Convencional	Grill	Turbo Grill	Pizza	Ar forçado	Maxi Cozedura	Pão Auto	Ar forçado Eco
ACESSÓRIOS								
	Grelha	Prato ou tabuleiro para assar na grelha metálica	Tabuleiro coletor/tabuleiro para assar ou grelha	Tabuleiro coletor	Tabuleiro coletor com 200 ml de água	Tabuleiro para pastelaria		

LIMPEZA E MANUTENÇÃO



Transfira o Guia de Utilização e Manutenção a partir de www.hotpoint.eu para obter mais informações

Não utilize aparelhos de limpeza a vapor.

Use luvas de proteção durante todas as operações.

Realize as operações requeridas com o forno a frio.

Desligue o aparelho da corrente elétrica.

Não utilize palha de aço, esfregões abrasivos ou produtos de limpeza abrasivos/corrosivos, uma vez que estes podem danificar as superfícies do aparelho.

SUPERFÍCIES EXTERIORES

- Limpe as superfícies com um pano de microfibra húmido. Se estiverem muito sujas, acrescente alguns pingos de detergente com PH neutro. Termine a limpeza com um pano seco.
- Não utilize detergentes corrosivos ou abrasivos. Se algum destes produtos entrar, inadvertidamente, em contacto com as superfícies do aparelho, limpe imediatamente com um pano de microfibra úmido.

SUPERFÍCIES INTERIORES

- Após cada utilização, deixe que o forno arrefeça e limpe-o, de preferência enquanto estiver morno, para remover eventuais depósitos ou manchas causados por resíduos de alimentos. Para secar qualquer condensação que se tenha formado devido à cozedura de alimentos com elevado teor

de água, deixe o forno arrefecer completamente e limpe-o com um pano ou uma esponja.

- Ative a função "Diamond Clean" para obter os melhores resultados de limpeza das superfícies internas do forno.
- A porta pode ser removida facilmente e instalada novamente para facilitar a limpeza do vidro .
- Limpe o vidro da porta com um detergente líquido adequado.
- A resistência superior da grelha pode ser baixada para limpar o painel superior do forno .

ACESSÓRIOS

Após a utilização, coloque os acessórios numa solução líquida de limpeza, pegando nos mesmos com luvas de forno, caso ainda estejam quentes. Os restos de alimentos podem ser retirados com uma esponja ou escova de limpeza.

REMOVER E REPOR A PORTA

1. Para remover a porta, abra-a totalmente e baixe as linguetas até ficarem na posição de desbloqueio.

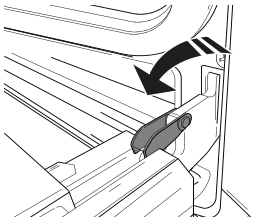

2. Feche a porta tanto quanto possível. Segure firmemente a porta com ambas as mãos – não a segure pela pega. Remova, simplesmente, a porta, continuando a fechá-la enquanto a puxa (a), simultaneamente, para cima, até se libertar do respetivo suporte (b).

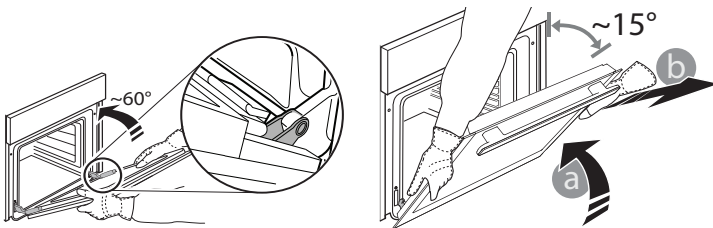

Coloque a porta de parte, apoiando-a sobre uma superfície suave.

3. Reponha a porta, deslocando-a na direção do forno e alinhando os ganchos das dobradiças com os respetivos suportes, fixando a parte superior aos suportes.

4. Baixe a porta e, em seguida, abra-a totalmente. Baixe as linguetas para a respetiva posição original: assegure-se de que as baixa totalmente.

5. Tente fechar a porta e assegure-se de que está alinhada com o painel de controlo. Se não estiver, repita os procedimentos acima.

CLIQUE PARA LIMPAR - LIMPAR O VIDRO

1. Após remover a porta e pousá-la sobre superfície suave, prima simultaneamente os dois grampos de retenção e remova a extremidade superior da porta, puxando-a na sua direção.

2. Levante e segure firmemente o vidro interior com ambas as mãos, removendo-o e colocando-o sobre uma superfície suave antes de proceder à sua limpeza.

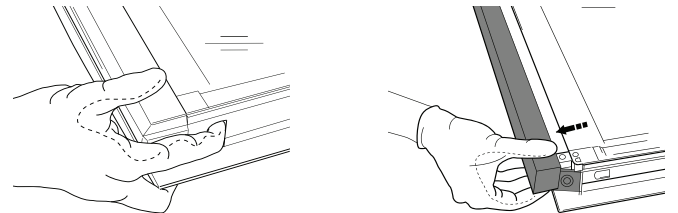

3. Para voltar a instalar o vidro interior, certifique-se de que a letra "R" está visível no canto esquerdo e que a superfície límpida (não impressa) está voltada para cima. Insira primeiro a parte mais longa do vidro com a indicação "R" nos suportes e, em seguida, baixe-a até à posição correta.

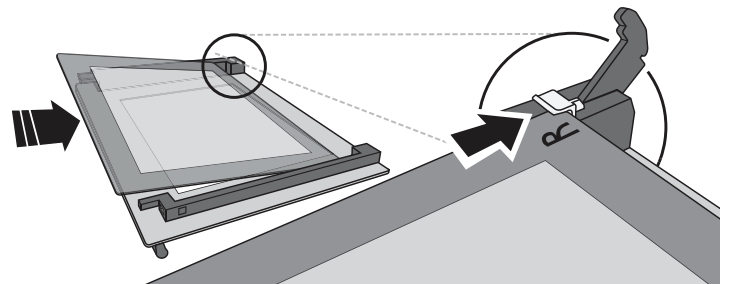

4. Instale novamente a extremidade superior: irá ouvir um clique, indicando que está bem posicionado. Certifique-se de que a vedação está segura antes de montar novamente a porta.



Problema	Causa possível	Solução
O forno não funciona	Corte de energia Desligado da rede elétrica	Verifique se existe energia elétrica proveniente da rede e se o forno está ligado à tomada elétrica. Desligue e volte a ligar o forno, para verificar se o problema ficou resolvido
O visor apresenta a letra apresenta a letra "F", seguida de um número	Problema de software	Contacte o Serviço Pós-Venda mais próximo e indique a letra ou o número que acompanha a letra "F"
O monitor mostra um texto pouco claro e parece estar partido.	Definir outro idioma.	Contacte o Centro de Assistência Pós-venda ao Cliente mais próximo.

CONSELHOS ÚTEIS



Transfira o Guia de Utilização e Manutenção a partir de www.hotpoint.eu para obter mais informações

COMO EFETUAR A LEITURA DA TABELA DE COZEDURA

A tabela indica a função, os acessórios e o nível mais adequados para utilizar na confecção dos diferentes tipos de alimentos. Os tempos de cozedura começam a partir do momento em que o alimento é colocado no forno, excluindo o pré-aquecimento (sempre que necessário). As temperaturas e os tempos de cozedura são aproximados e dependem da quantidade de alimento e do tipo de acessório utilizado. Comece por utilizar as definições mais baixas recomendadas e, se o alimento não ficar bem cozinhado, mude para definições mais elevadas. Utilize os acessórios fornecidos e, de preferência, formas para bolos e tabuleiros para assar metálicos e de cor escura. Também poderá utilizar recipientes e acessórios em cerâmica ou pirex, mas tenha em conta que os tempos de cozedura serão ligeiramente superiores.

COZINHAR DIFERENTES ALIMENTOS EM SIMULTÂNEO

A função "Ar forçado" permite-lhe cozinhar, simultaneamente, diferentes alimentos (como peixe e legumes) em diferentes níveis. Retire os alimentos que necessitam de um tempo de cozedura mais curto e deixe no forno os alimentos que necessitam de um tempo de cozedura mais longo.

FUNÇÃO PÃO AUTO

Para obter os melhores resultados possíveis, deve seguir cuidadosamente as instruções e a receita para misturar 1000 g de massa: 600 g de farinha, 360 g de água, 11 g de sal, 25 g de fermento (ou dois pacotes de fermento em pó).

Para obter os melhores resultados de levedação, deixe a massa respirar durante aproximadamente 90 minutos à temperatura ambiente ou durante aproximadamente 60 minutos no forno utilizando a função "Levedura".

Coloque a massa no forno (frio), verta 100 cc de água potável fria no fundo do forno e ative a função "Pão Auto". Após a cozedura, deixe a massa repousar na grelha metálica até que arrefeça totalmente.

FICHA DE PRODUTO

A ficha do produto, incluindo os dados energéticos para este aparelho, pode ser transferida a partir do website www.hotpoint.eu

COMO OBTER O GUIA DE UTILIZAÇÃO E MANUTENÇÃO

> Transfira o Guia de Utilização e Manutenção a partir do nosso website www.hotpoint.eu (pode utilizar este código QR), especificando o código comercial do produto.



> Em alternativa, contacte o nosso Serviço Pós-Venda



CONTACTAR O NOSSO SERVIÇO PÓS-VENDA

Pode encontrar os nossos contactos no manual de garantia. Ao contactar o nosso Serviço Pós-Venda, indique os códigos fornecidos na placa de identificação do seu produto.

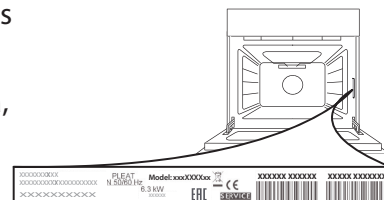

400011597418

Impresso em Itália

GUÍA DE CONSULTA DIARIA



GRACIAS POR HABER ADQUIRIDO UN PRODUCTO HOTPOINT - ARISTON

Si desea recibir asistencia y soporte adicionales, registre su producto en www.hotpoint.eu/register



Puede descargarse las Instrucciones de seguridad y la Guía de uso y cuidado en nuestra página web www.hotpoint.eu, siguiendo las instrucciones que figuran al dorso de este documento.



Antes de usar el producto, lea atentamente las instrucciones de seguridad

DESCRIPCIÓN DEL PRODUCTO

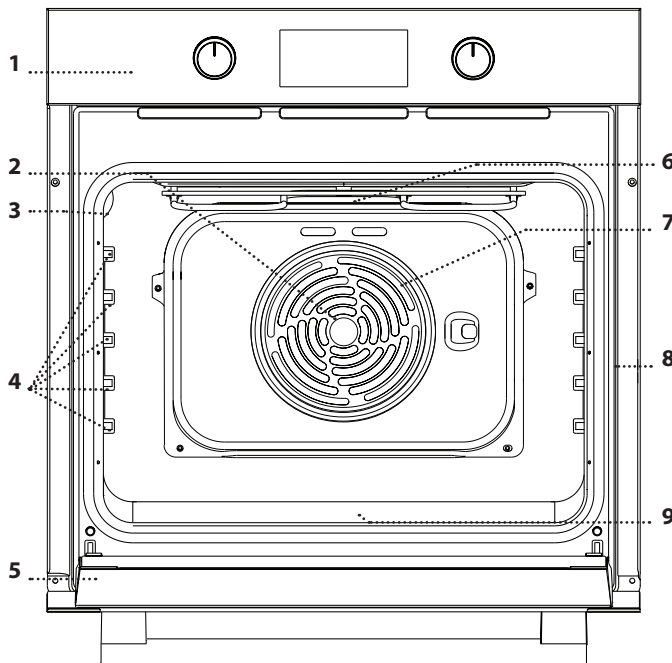

1. Panel de control
2. Ventilador
3. Lámpara
4. Guías para los estantes
(el nivel está indicado en la pared del compartimento de cocción)
5. Puerta
6. Resistencia superior/grill
7. Resistencia circular
(no visible)
8. Placa de características
(no debe retirarse)
9. Resistencia inferior
(no visible)

PANEL DE CONTROL

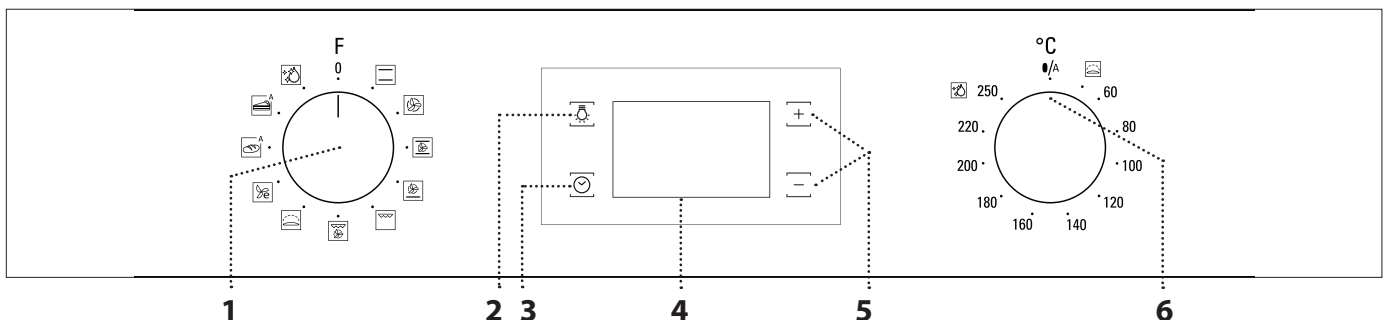

1. SELECTOR

Para encender el horno seleccionando una función. Póngalo en la posición 0 para apagar el horno.

2. LUZ

Con el horno encendido, pulse para apagar o encender la bombilla del compartimento del horno.

3. AJUSTE DE LA HORA

Para acceder a la configuración del tiempo de cocción, el inicio diferido y el temporizador. Para mostrar la hora cuando el horno está apagado.

4. PANTALLA

5. BOTONES DE AJUSTE

Para cambiar la configuración del tiempo de cocción.

6. SELECTOR DEL TERMOSTATO

Gire para seleccionar la temperatura deseada cuando active las funciones manuales. Uso de funciones automáticas /A.

Hotpoint

ARISTON

REJILLA

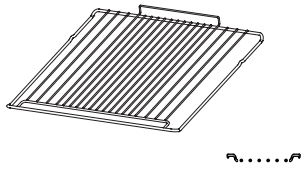

GRASERA

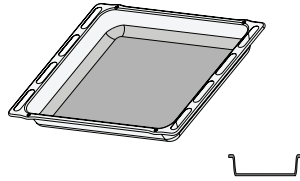

BANDEJA DE HORNEAR

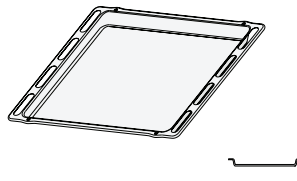

El número de accesorios puede variar de un modelo a otro. Se pueden adquirir otros accesorios por separado en el Servicio Postventa.

INTRODUCCIÓN DE LA REJILLA Y OTROS ACCESORIOS

• En primer lugar, introduzca la rejilla en el nivel necesario sujetándola ligeramente inclinada hacia arriba y descansando la parte trasera elevada (apuntando hacia arriba). Luego deslícela horizontalmente por la guía lo más que pueda.

• Los demás accesorios, como la grasera y la bandeja pastelera, se introducen horizontalmente deslizándolos por las guías.

FUNCIONES

CONVENCIONAL*

Para cocinar cualquier tipo de alimento en un nivel.

AIRE FORZADO

Para cocinar diferentes tipos de alimentos que requieran la misma temperatura de cocción en diferentes estantes (máximo tres) al mismo tiempo. Esta función puede utilizarse para cocinar diferentes alimentos sin que se mezclen los olores.

MAXI-COCCIÓN

Para cocinar piezas de carne de gran tamaño (más de 2,5 kg). Le recomendamos darle la vuelta a la carne durante la cocción para que los dos lados se doren uniformemente. También le recomendamos rociar las piezas de carne de vez en cuando para que no se seque demasiado.

PIZZA

Para cocinar distintos tipos y formatos de pan y pizza. Es recomendable cambiar la posición de las bandejas pasteleras a medio proceso de cocción.

GRILL

Para asar filetes, pinchos morunos y salchichas, cocinar verduras gratinadas o tostar pan. Cuando ase carne, le recomendamos colocar la grasera debajo para recoger los jugos de cocción: Coloque el recipiente en cualquiera de los niveles debajo de la rejilla y añada 200 ml de agua potable.

TURBO GRILL

Para asar grandes piezas de carne (pierna de cordero, rosbif, pollo). Le recomendamos utilizar la grasera para recoger los jugos de la cocción: Coloque el recipiente en cualquiera de los niveles debajo de la rejilla y añada 200 ml de agua potable.

FERMENTAR MASAS

Para hacer que las masas dulces o saladas fermenten bien. Para garantizar la calidad del leudado, no active la función si el horno está caliente después de un ciclo de cocción.

ECO AIRE FORZADO*

Para cocinar piezas de carne asadas y carnes rellenas en un solo estante. Para evitar que los alimentos se resequen, el aire circula de manera suave e intermitente. Cuando se utiliza la función ECO, la luz permanece apagada durante la cocción pero se puede volver a encender momentáneamente pulsando .

PAN AUTO

Esta función selecciona automáticamente la temperatura y el tiempo de cocción ideales para el pan. Para obtener mejores resultados, siga la receta . Active la función con el horno frío.

PASTELERÍA AUTO

Esta función selecciona automáticamente la temperatura y el tiempo de cocción ideales para pasteles. Active la función con el horno frío.



DIAMOND CLEAN

La acción del vapor liberado durante este ciclo especial de limpieza a baja temperatura permite eliminar la suciedad y los residuos de alimentos con facilidad. Vierta 200 ml de agua potable en el fondo del horno y active la función únicamente cuando el horno esté frío.







* Función utilizada como referencia para la declaración de eficiencia energética de conformidad con la normativa (EU) No. 65/2014

PRIMER USO

1. AJUSTE DE LA HORA

La primera vez que encienda el aparato, tendrá que ajustar la hora: pulse  hasta que el icono  y los dos dígitos de la hora empiecen a parpadear en la pantalla.



Utilice  o  para ajustar la hora y pulse  para confirmar. Los dos dígitos de los minutos empezarán a parpadear. Utilice  o  para ajustar los minutos y pulse  para confirmar.

Nota: Si el icono  parpadea, por ejemplo después de un corte de corriente muy largo, será necesario volver a ajustar la hora.

2. CÓMO RECALENTAR EL HORNO

Un horno nuevo puede liberar olores que se han quedado impregnados durante la fabricación: es completamente normal.

Antes de empezar a cocinar, le recomendamos calentar el horno en vacío para eliminar cualquier olor.

Quite todos los cartones de protección o el film transparente del horno y saque todos los accesorios de su interior.

Caliente el horno a 250 °C durante aproximadamente una hora utilizando preferiblemente la función de «Maxi-cocción». Durante este tiempo, el horno debe permanecer vacío.

Siga las instrucciones para configurar la función correctamente.

Nota: Es aconsejable ventilar la habitación después de usar el aparato por primera vez.

USO DIARIO

1. SELECCIONAR UNA FUNCIÓN

Para seleccionar una función, gire el *selector* hasta el símbolo de la función deseada: la pantalla se encenderá y se oír una señal.



2. ACTIVAR UNA FUNCIÓN

MANUAL

Para iniciar la función seleccionada, gire el *selector del termostato* hasta la temperatura deseada.



Nota: Puede cambiar la función durante la cocción girando el *selector* o ajustar la temperatura girando el *selector del termostato*.

La función no se iniciará si el selector del termostato está a 0 °C. Puede programar el tiempo de cocción, el tiempo de finalización de la cocción (solo si selecciona un tiempo de cocción) y un temporizador.

AUTOMÁTICO

Para iniciar la función automática seleccionada («Pan» o «Pastelería»), mantenga el *selector del termostato* en la posición de funciones automáticas (0/A).

Para finalizar la cocción, gire el *selector* hasta la posición 0.

Nota: Puede programar el tiempo de finalización de la cocción y un temporizador.

LEUDADO

Para activar la función «Leudado», gire el *selector del termostato* al símbolo correspondiente; si el horno está programado con una temperatura diferente, la función no se activará.

Nota: Puede configurar el tiempo de cocción, el tiempo de finalización de la cocción (solo si ha establecido un tiempo de cocción) y el temporizador.

3. PRECALENTANDO

Una vez iniciada la función, una señal acústica y un icono parpadeando  en la pantalla le indicarán que la fase de precalentamiento se ha activado.



Al finalizar esta fase, una señal acústica y el icono fijo  en la pantalla indican que el horno ha alcanzado la temperatura establecida: en ese momento, coloque los alimentos dentro y proceda con la cocción.

Nota: Colocar los alimentos en el horno antes de que haya finalizado el precalentado puede tener efectos adversos en el resultado final de la cocción.



. COCCIÓN PROGRAMADA

Antes de comenzar la cocción, deberá seleccionar una función.



DURACIÓN

Mantenga pulsado  hasta que el icono  y «00:00» empiecen a parpadear en la pantalla.





Utilice  o  para configurar el tiempo de cocción deseado y después pulse  para confirmar.

Active la función girando el *selector del termostato* a la temperatura que desee: Sonará una señal acústica y la pantalla indicará que la cocción ha terminado.



Notas: Para cancelar el tiempo de cocción que ha programado, mantenga pulsado  hasta que el icono  empiece a parpadear en la pantalla, luego utilice  para poner el tiempo de cocción en "00:00".

Este tiempo de cocción incluye una fase de precalentamiento.

SELECCIONAR LA HORA DE FINALIZACIÓN DE LA COCCIÓN / INICIO DIFERIDO

Después de programar un tiempo de cocción, si desea activar la función más tarde deberá programar el tiempo de finalización: pulse  hasta que el icono  y la hora actual empiecen a parpadear en la pantalla.



Utilice  o  para ajustar el tiempo deseado de finalización de la cocción y pulse  para confirmar. Active la función girando el *selector del termostato* a la temperatura que desee: Esta función permanecerá en pausa hasta que inicie automáticamente cuando haya transcurrido el periodo de tiempo calculado para que la cocción termine a la hora programada.



Notas: Para cancelar la configuración, apague el horno girando el **selector** hasta la posición « 0 ».

La función de inicio retardado no está disponible para las funciones Grill y Turbo Grill.

FINAL DE COCCIÓN

Sonará una señal acústica y la pantalla indicará que la función ha terminado.

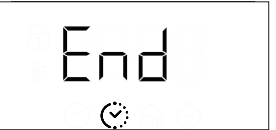



Gire el *selector* para seleccionar una función diferente o póngalo en la posición « 0 » para apagar el horno.

Nota: Si el temporizador está activado, la pantalla mostrará la palabra «END» alternada con el tiempo restante.

. CONFIGURAR EL TEMPORIZADOR



Esta opción no interrumpe ni programa la cocción, pero le permite utilizar la pantalla como temporizador, tanto si la función está activada como si el horno está apagado.

Mantenga pulsado  hasta que el icono  y «00:00» empiecen a parpadear en la pantalla.



Utilice  o  para configurar la hora y pulse  para confirmar.

Una vez que haya finalizado la cuenta atrás sonará una señal acústica.

Notas: Para desactivar el temporizador, mantenga pulsado  hasta que el icono  empieza a parpadear, luego utilice  para poner el tiempo en "00:00".

. FUNCIÓN DIAMOND CLEAN

Para activar la función de limpieza «Diamond Clean», vierta 200 ml de agua potable en la base del horno, después gire el *selector* y el *selector del termostato* hasta el icono .

Nota: La posición del icono no se corresponde con la temperatura alcanzada durante el ciclo de limpieza.

La función se activará automáticamente: la pantalla mostrará el tiempo restante alternado con el mensaje «DC».



Nota: Solo se puede programar la hora de finalización de esta función. La duración se programa automáticamente en 35 minutos.

TABLA DE COCCIÓN

RECETA	FUNCIÓN	PRECALENTAMIENTO	TEMPERATURA (°C)	DURACIÓN (MIN)	NIVEL Y ACCESORIOS
Bizcochos		Sí	160-180	30-90	2/3
		Sí	160-180	30-90	4 1
Bizcocho relleno (tarta de queso, pastel de hojaldre relleno, tarta de frutas)		Sí	160-200	35-90	2
		Sí	160-200	40-90	4 2
Galletas, tartaletas		Sí	160-180	20-45	3
		Sí	150 - 170	20-45	4 2
		Sí	150 - 170	20-45	5 3 1
Petit choux		Sí	180 - 210	30-40	3
		Sí	180-200	35-45	4 2
		Sí	180-200	35-45	5 3 1
Merengues		Sí	90	150 - 200	3
		Sí	90	140 - 200	4 2
		Sí	90	140 - 200	5 3 1
Pizza/pan		Sí	190-250	15-50	1 / 2
		Sí	190-250	20-50	4 2
Pan		-	-	60	2
Pizza congelada		Sí	250	10 - 20	3
		Sí	230 - 250	10 -25	4 2
Tartas saladas (tarta de verdura, quiche)		Sí	180-200	40-55	3
		Sí	180-200	45 - 60	4 2
		Sí	180-200	45 - 60	5 3 1
Volovanes/hojaldres		-	190-200	20-30	3
		-	180-190	20-40	4 2
		-	180-190	20-40	5 3 1

FUNCIONES								
	Convencional	Grill	Turbo Grill	Pizza	Aire forzado	Maxi-coCCIÓN	Pan automático	Eco aire forzado

ACCESORIOS								
	Rejilla	Fuente para horno o bandeja pastelera sobre la rejilla	Grasera /plato para hornear sobre la rejilla	Grasera	Grasera con 200 ml de agua	Bandeja pastelera		

RECETA	FUNCIÓN	PRECALENTAMIENTO	TEMPERATURA (°C)	DURACIÓN (MIN)	NIVEL Y ACCESORIOS
Lasaña/pasta al horno/canelones/budines		Sí	190-200	45-65	2
Cordero/ternera/buey/cerdo 1 kg		Sí	190-200	80-110	3
Cerdo asado con torreznos 2 kg		Sí	180-190	110-150	2
Pollo/conejo/pato 1 kg		Sí	200-230	50-100	2
Pavo/oca 3 kg		-	190-200	100 - 160	2
Pescado al horno/en papillote (lomos, entero)		Sí	170 - 190	30 - 50	2
Verduras rellenas (tomates, calabacines, berenjenas)		Sí	180-200	50-70	2
Pan tostado		-	250	2 - 6	5
Filetes/rodajas de pescado		-	230 - 250	20 - 30*	4 3
Salchichas, pinchos morunos, costillas, hamburguesas		-	250	15 - 30*	5 4
Pollo asado 1-1,3 kg		Sí	200 - 220	55 - 70**	2 1
Rosbif poco hecho 1 kg		Sí	200 - 210	35 - 50**	3
Pierna o jarrete de cordero		Sí	200 - 210	60 - 90**	3
Patatas al horno		Sí	200 - 210	35 - 55**	3
Verduras gratinadas		-	200 - 210	25 - 55	3
Carnes y patatas		Sí	190-200	45 - 100***	4 1
Pescados y verduras		Sí	180	30 - 50***	4 1
Lasañas y carnes		Sí	200	50 - 100***	4 1
Menú completo: tarta de frutas (nivel 5)/ lasaña (nivel 3)/ carne (nivel 1)		Sí	180-190	40 - 120***	5 3 1
Carne asada / carne rellena asada		-	170-180	100 - 150	2

El tiempo indicado no incluye la fase de precalentado: le recomendamos poner la comida en el horno y programar el tiempo de cocción después de que haya alcanzado la temperatura necesaria.

* Dar la vuelta al alimento a mitad de la cocción

** Darle la vuelta al alimento en el segundo tercio de la cocción (si fuera necesario).

*** Tiempo de cocción estimado: Los platos se pueden extraer del horno antes o después según los gustos personales.

Descargue la Guía de uso y cuidado en nuestra página web www.hotpoint.eu para consultar la tabla de recetas probadas, cumplimentada para las autoridades de certificación de conformidad con la norma IEC 60350-1.

FUNCIONES								
	Convencional	Grill	Turbo Grill	Pizza	Aire forzado	Maxi-cocción	Pan automático	Eco aire forzado
ACCESORIOS								
	Rejilla	Fuente para horno o bandeja pastelera sobre la rejilla	Graspera /plato para hornear sobre la rejilla	Graspera	Graspera con 200 ml de agua	Bandeja pastelera		

LIMPIEZA Y MANTENIMIENTO



Para más información, descargue la Guía de uso y cuidado de www.hotpoint.eu

No utilice aparatos de limpieza al vapor.

Utilice guantes de protección para todas las operaciones.

Lleve a cabo todas las operaciones con el horno frío.

Desconecte el aparato de la red eléctrica.

No utilice estropajos de acero, estropajos abrasivos ni productos de limpieza abrasivos/corrosivos, ya que podrían dañar las superficies del aparato.

SUPERFICIES EXTERIORES

- Limpie las superficies con un paño húmedo de microfibra. Si están muy sucias, añada unas gotas de detergente neutro al agua. Seque con un paño seco.
- No utilice detergentes corrosivos ni abrasivos. Si uno de esos productos entra accidentalmente en contacto con la superficie del aparato, límpielo de inmediato con un paño húmedo de microfibra.

SUPERFICIES INTERIORES

- Después de cada uso, deje que el horno se enfríe y, a continuación, límpielo, preferiblemente cuando aún esté tibio, para quitar los restos o las manchas causadas por los residuos de los alimentos. Para secar la condensación que se haya podido formar debido a la cocción de alimentos con un alto contenido en agua, deje que el horno se enfríe por completo y límpielo con un paño o esponja.

- Active la función «Diamond Clean» para unos resultados de limpieza óptimos de las superficies internas.
- La puerta se puede montar y desmontar para facilitar la limpieza del cristal .
- Limpie el cristal de la puerta con un detergente líquido adecuado.
- La resistencia superior del grill se puede bajar para limpiar el panel superior del horno .

ACCESORIOS

Después del uso sumerja los accesorios en una solución líquida con detergente, utilice guantes si aún están calientes. Los residuos de alimentos pueden quitarse con un cepillo o esponja.

EXTRACCIÓN E INSTALACIÓN DE LA PUERTA

1. Para quitar la puerta, ábrala por completo y baje los pestillos hasta que estén en posición desbloqueada.

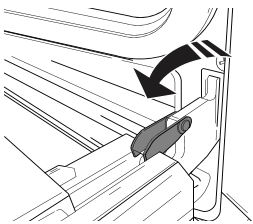

2. Cierre la puerta tanto como pueda. Sujete bien la puerta con las dos manos –no la sujete por el asa. Simplemente extraiga la puerta cerrándola mientras tira de ella hacia arriba (a) hasta que salga de su alojamiento (b).

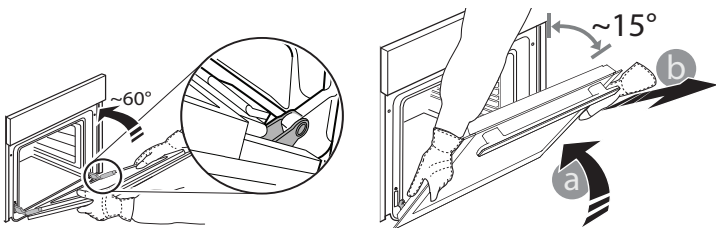

Ponga la puerta en un lado, apoyada sobre una superficie blanda.

3. Vuelva a instalar la puerta llevándola hacia el horno, alineando los ganchos de las ranuras con sus alojamientos y fijando la parte superior en su alojamiento.

4. Baje la puerta y ábrala por completo. Baje los pestillos a su posición original: asegúrese de haberlos bajado por completo.

5. Intente cerrar la puerta y compruebe que está alineada con el panel de control. Si no lo está, repita los pasos de arriba.

HAGA CLIC PARA LIMPIAR - LIMPIEZA DEL CRISTAL

1. Después de desmontar la puerta y colocarla sobre una superficie blanda con las asas hacia abajo, pulse simultáneamente los dos enganches de retención y extraiga la parte superior de la puerta tirando hacia usted.

2. Sujete los cristales interiores firmemente con las dos manos, extráigalos y colóquelos sobre una superficie blanda antes de limpiarlos.

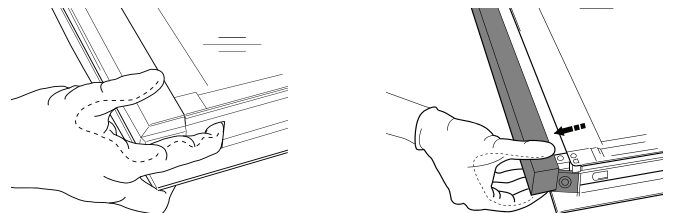

3. Para volver a colocar los cristales interiores correctamente, asegúrese de que «R» se pueda leer en la esquina izquierda y la superficie lisa (no impresa) esté cara arriba.

Primero introduzca el lado largo del cristal marcado con una «R» en los soportes y después bájelos hasta su posición.

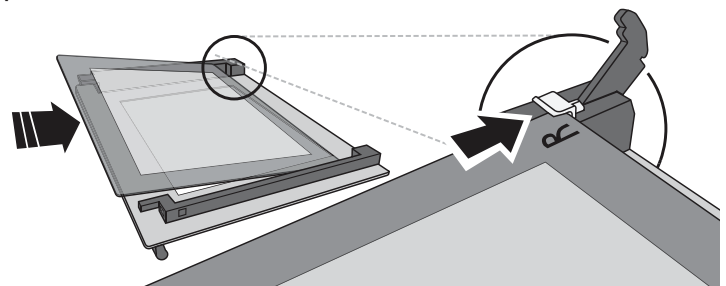

4. Vuelva a montar el borde superior: un clic indicará la posición correcta. Antes de montar la puerta, compruebe que la junta de sellado está segura.

Problema	Posible causa	Solución
El horno no funciona	Corte de suministro Desconexión de la red eléctrica	Compruebe que haya corriente eléctrica en la red y que el horno esté enchufado a la toma de electricidad. Apague el horno y vuelva a encenderlo para comprobar si se ha solucionado el problema
En la pantalla aparecerá la letra «F» seguida de un número	Problema de software	Póngase en contacto con el Servicio Postventa más cercano e indique la letra o número que aparece después de la letra «F»
La pantalla muestra un texto poco claro y parece estar rota.	Otro idioma configurado.	Póngase en contacto con el Centro de atención al cliente más cercano

CONSEJOS ÚTILES



Para más información, descargue la Guía de uso y cuidado de www.hotpoint.eu

CÓMO UTILIZAR LA TABLA DE COCCIÓN

La tabla indica la mejor función, accesorios y nivel para cocinar los diferentes tipos de alimentos. Los tiempos de cocción inician en el momento en que se coloca el alimento en el horno, excluyendo el precalentamiento (cuando sea necesario). Las temperaturas y los tiempos de cocción son orientativos y dependen de la cantidad de alimentos y del tipo de accesorio utilizado. En principio, aplique los valores de ajuste recomendados más bajos y, si la cocción no es suficiente, aumentelos. Utilice los accesorios suministrados y, si es posible, moldes y bandejas pasteleras metálicas de color oscuro. También puede utilizar recipientes y accesorios tipo pírex o de cerámica, aunque deberá tener en cuenta que los tiempos de cocción serán ligeramente mayores.

COCCIÓN DE VARIOS ALIMENTOS A LA VEZ

La función "Aire forzado" le permite cocinar diferentes alimentos (pescado y verduras) en diferentes niveles al mismo tiempo. Retire del horno los alimentos que requieran menor tiempo de cocción y deje los que necesiten una cocción más prolongada.

FUNCIÓN PAN AUTO

Para unos resultados mejores, siga las instrucciones atentamente y utilice la receta para mezclar 1000 g de masa: 600 g de harina, 360 g de agua, 11 g de sal, 25 g de levadura fresca (o dos paquetes de levadura en polvo).

Para un leudado óptimo, deje unos 90 minutos a temperatura ambiente o 60 minutos en el horno usando la función de «Leudado».

Ponga la masa en el horno (frío), vierta 100 cc de agua potable fría en la parte inferior del horno y active la función «Pan Auto». Después de la cocción, deje que la masa repose en la rejilla hasta que se enfríe del todo.

FICHA DEL PRODUCTO

La ficha del producto, que incluye los datos de energía de este aparato, se puede descargar en el sitio web www.hotpoint.eu

CÓMO OBTENER LA GUÍA DE USO Y CUIDADO

> Descargue la Guía de uso y cuidado en nuestra página web www.hotpoint.eu (puede utilizar este código QR), especificando el código del producto.



> También puede ponerse en contacto con nuestro Servicio Postventa

CÓMO PONERSE EN CONTACTO CON NUESTRO SERVICIO POSTVENTA

Encontrará nuestros datos de contacto en el manual de garantía. Cuando se ponga en contacto con nuestro Servicio Postventa, deberá indicar los códigos que figuran en la placa de características de su producto.

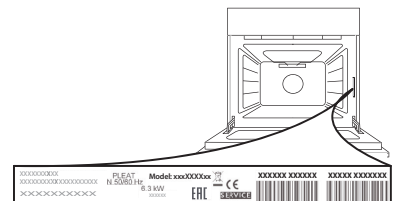

400011597418

Impreso en Italia



DAILY REFERENCE GUIDE



THANK YOU FOR PURCHASING AN HOTPOINT-ARISTON PRODUCT

To receive more comprehensive help and support, please register your product at www.hotpoint.eu/register



You can download the Safety Instructions and the Use and Care Guide by visiting our website www.hotpoint.eu and following the instructions on the back of this booklet.



Read the safety instructions carefully before using the product

PRODUCT DESCRIPTION

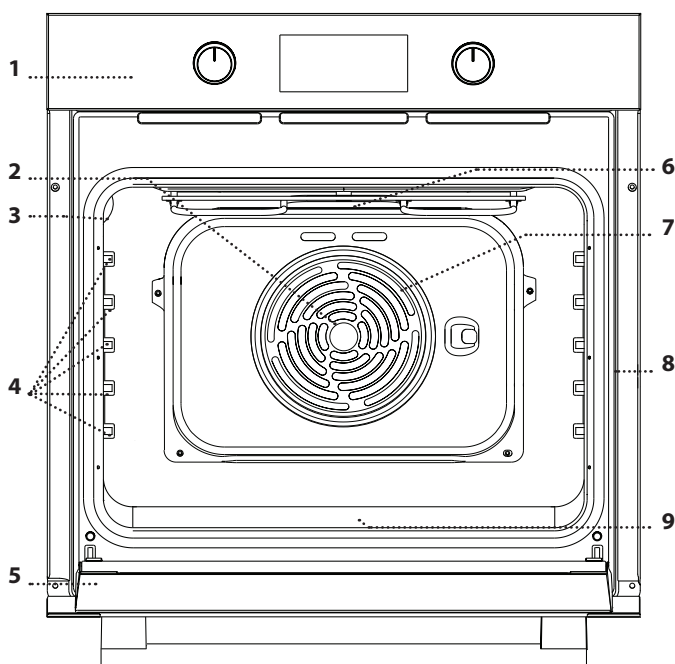

1. Control panel
2. Fan
3. Lamp
4. Shelf guides
(the level is indicated on the wall of the cooking compartment)
5. Door
6. Upper heating element/grill
7. Circular heating element
(non-visible)
8. Identification plate
(do not remove)
9. Bottom heating element
(non-visible)

CONTROL PANEL

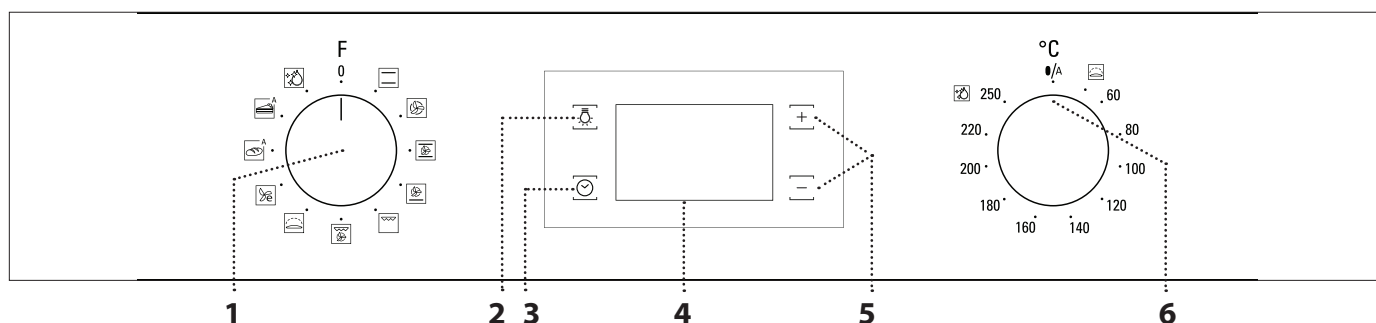

1. SELECTION KNOB

For switching the oven on by selecting a function. Turn to the 0 position to switch the oven off.

2. LIGHT

With the oven switched on, press to turn the oven compartment lamp on or off.

3. SETTING THE TIME

For accessing the cooking time settings, delayed start and timer. For displaying the time when the oven is off.

4. DISPLAY

5. ADJUSTMENT BUTTONS

For changing the cooking time settings.

6. THERMOSTAT KNOB

Turn to select the temperature you require when activating manual functions. Automatic functions use \bullet/A .

WIRE SHELF

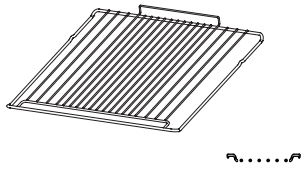

DRIP TRAY

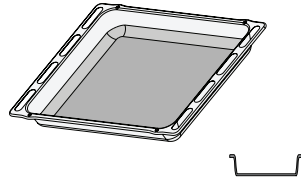

BAKING TRAY

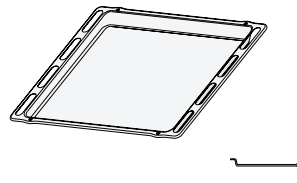

The number of accessories may vary depending on which model is purchased. Other accessories can be purchased separately from the After-sales Service.

INSERTING THE WIRE SHELF AND OTHER ACCESSORIES

. Insert the wire shelf onto the level you require by holding it tilted slightly upwards and resting the raised rear side (pointing upwards) down first. Then slide it horizontally along the shelf guide as far as possible.

. The other accessories, such as the drip tray and the baking tray, are inserted horizontally by sliding them along the shelf guides.

FUNCTIONS

CONVENTIONAL*
For cooking any kind of dish on one shelf only.

FORCED AIR
For cooking different foods that require the same cooking temperature on several shelves (maximum three) at the same time. This function can be used to cook different foods without odours being transferred from one food to another.

MAXI COOKING
For cooking large joints of meat (above 2.5 kg). We recommend turning the meat over during cooking to ensure that both sides brown evenly. We also recommend basting the joint every so often to prevent it from drying out excessively.

PIZZA
For baking different types and sizes of pizza and bread. It is a good idea to swap the position of the baking trays halfway through cooking.

GRILL
For grilling steaks, kebabs and sausages, cooking vegetables au gratin or toasting bread. When grilling meat, we recommend using a drip tray to collect the cooking juices: position the pan on any of the levels below the wire shelf and add 200 ml of drinking water.

TURBO GRILL
For roasting large joints of meat (legs, roast beef, chicken). We recommend using a drip tray to collect the cooking juices: position the pan on any of the levels below the wire shelf and add 200 ml of drinking water.

RISING
For helping sweet or savoury dough to rise effectively. To maintain the quality of proving, do not activate the function if the oven is still hot following a cooking cycle.

ECO FORCED AIR*
For cooking roasts and stuffed roasting joints on a single shelf. Food is prevented from drying out excessively by gentle, intermittent air circulation. When this ECO function is in use, the light will remain switched off during cooking but can be switched on again by pressing .

^A BREAD AUTO
This function automatically selects the ideal temperature and baking time for bread. For best results, carefully follow the recipe . Activate the function when the oven is cold.



^A PASTRY AUTO
This function automatically selects the ideal temperature and baking time for cakes. Activate the function when the oven is cold.

DIAMOND CLEAN
The action of the steam released during this special low-temperature cleaning cycle allows dirt and food residues to be removed with ease. Pour 200 ml of drinking water on the bottom of the oven and only activate the function when the oven is cold.







* Function used as reference for the energy efficiency declaration in accordance with Regulation (EU) No. 65/2014

USING THE APPLIANCE FOR THE FIRST TIME

1. SETTING THE TIME

You will need to set the time when you switch on the appliance for the first time: press  until the  icon and the two digits for the hour start flashing on the display.



Use  or  to set the hour and press  to confirm. The two digits for the minutes will start flashing. Use  or  to set the minutes and press  to confirm.

Please note: When the  icon is flashing, for example following lengthy power outages, you will need to reset the time.

2. REHEAT THE OVEN

A new oven may release odours that have been left behind during manufacturing: this is completely normal.

Before starting to cook food, we therefore recommend heating the oven with it empty in order to remove any possible odours.

Remove any protective cardboard or transparent film from the oven and remove any accessories from inside it.

Heat the oven to 250 °C for about one hour, preferably using the “Maxi cooking” function. The oven must be empty during this time.

Follow the instructions for setting the function correctly.

Please note: It is advisable to air the room after using the appliance for the first time.

DAILY USE

1. SELECT A FUNCTION

To select a function, turn the *selection knob* to the symbol for the function you require: the display will light up and an audible signal will sound.



2. ACTIVATE A FUNCTION

MANUAL

To start the function you have selected, turn the *thermostat knob* to set the temperature you require.



Please note: During cooking you can change the function by turning the *selection knob* or adjust the temperature by turning the *thermostat knob*.

The function will not start if the thermostat knob is on 0 °C. You can set the cooking time, cooking end time (only if you set a cooking time) and a timer.

AUTOMATIC

To start the automatic function you have selected (“Bread” or “Pastry”), keep the *thermostat knob* at the position for automatic functions (0/A).

To finish cooking, turn the *selection knob* to position 0.

Please note: You can set the cooking end time and timer.

RISING

To start the “Rising” function, turn the *thermostat knob* to the relevant symbol; if the oven is set to a different temperature, the function will not start.

Please note: You can set the cooking time, cooking end time (only if you set a cooking time) and a timer.

3. PREHEATING

Once the function starts, an audible signal and a flashing icon  on the display indicate that the preheating phase has been activated.

At the end of this phase, an audible signal and the fixed icon  on the display will indicate that the oven has reached the set temperature: at this point, place the food inside and proceed with cooking.

Please note: Placing the food in the oven before preheating has finished may have an adverse effect on the final cooking result.



. PROGRAMMING COOKING

You will need to select a function before you can start programming cooking.



DURATION

Keep pressing  until the  icon and “00:00” start flashing on the display.





Use  or  to set the cooking time you require, then press  to confirm.



Activate the function by turning the *thermostat knob* to the temperature you require: an audible signal will sound and the display will indicate that cooking is complete.

Notes: To cancel the cooking time you have set, keep pressing  until the  icon starts flashing on the display, then use  to reset the cooking time to “00:00”. This cooking time includes a preheating phase.

PROGRAMMING THE END COOKING TIME/DELAYED START

After a cooking time has been set, starting the function can be delayed by programming its end time: press  until the  icon and the current time start flashing on the display.



Use  or  to set the time you want cooking to end and press  to confirm.

Activate the function by turning the *thermostat knob* to the temperature you require: the function will remain paused until it starts automatically after the period of time that has been calculated in order for cooking to finish at the time you have set.



Notes: To cancel the setting, switch the oven off by turning the *selection knob* to position "0".

Delay to start functionality is not available for Grill and Turbo Grill functions.

END OF COOKING

An audible signal will sound and the display will indicate that the function has finished.





Turn the *selection knob* to select a different function or to position "0" to switch the oven off.



Please note: If the timer is active, the display will show "END" alternately with the remaining time.

. SETTING THE TIMER

This option does not interrupt or program cooking but allows you to use the display as a timer, either during while a function is active or when the oven is off.

Keep pressing  until the  icon and "00:00" start flashing on the display.



Use  or  to set the time you require and press  to confirm.

An audible signal will sound once the timer has finished counting down the selected time.

Notes: To cancel the timer, keep pressing  until the  icon starts flashing, then use  to reset the time to "00:00".

. DIAMOND CLEAN FUNCTION

To activate the "Diamond Clean" cleaning function, pour 200 ml of drinking water into the bottom of the oven, then turn the *selection knob* and the *thermostat knob* to the  icon.

















































































Please note: The position of the icon does not correspond to the temperature reached during the cleaning cycle.

The function will activate automatically: the display shows the time remaining to the end, alternating with "DC".



Please note: It is only possible to programme the end time of this function. The duration is automatically set to 35 minutes.

COOKING TABLE

RECIPE	FUNCTION	PREHEAT	TEMPERATURE (°C)	DURATION (MIN)	LEVEL AND ACCESSORIES			
Leavened cakes		Yes	160-180	30-90	2/3 			
		Yes	160-180	30-90	4  1 			
Filled cake (cheesecake, strudel, fruit pie)		Yes	160-200	35-90	2 			
		Yes	160-200	40-90	4  2 			
Biscuits/tartlets		Yes	160-180	20-45	3 			
		Yes	150 - 170	20-45	4  2 			
		Yes	150 - 170	20-45	5  3  1 			
Choux buns		Yes	180 - 210	30-40	3 			
		Yes	180-200	35-45	4  2 			
		Yes	180-200	35-45	5  3  1 			
Meringues		Yes	90	150 - 200	3 			
		Yes	90	140 - 200	4  2 			
		Yes	90	140 - 200	5  3  1 			
Pizza/bread		Yes	190-250	15-50	1 / 2 			
		Yes	190-250	20-50	4  2 			
Bread		-	-	60	2 			
Frozen pizza		Yes	250	10 - 20	3 			
		Yes	230 - 250	10 -25	4  2 			
Salty cakes (vegetable pie, quiche)		Yes	180-200	40-55	3 			
		Yes	180-200	45 - 60	4  2 			
		Yes	180-200	45 - 60	5  3  1 			
Vols-au-vents/puff pastry crackers		-	190-200	20-30	3 			
		-	180-190	20-40	4  2 			
		-	180-190	20-40	5  3  1 			
FUNCTIONS								
ACCESSORIES								
	Conventional	Grill	Turbo Grill	Pizza	Forced Air	Maxi Cooking	Bread Auto	Eco Forced Air
	Wire shelf	Baking dish or baking tray on the wire shelf	Drip tray/baking tray on the wire shelf	Drip tray	Drip tray with 200 ml of water	Baking tray		

RECIPE	FUNCTION	PREHEAT	TEMPERATURE (°C)	DURATION (MIN)	LEVEL AND ACCESSORIES
Lasagne/baked pasta/cannelloni/flans		Yes	190-200	45-65	2
Lamb/veal/beef/pork 1 kg		Yes	190-200	80-110	3
Roast pork with crackling 2 kg		Yes	180-190	110-150	2
Chicken/rabbit/duck 1 kg		Yes	200-230	50-100	2
Turkey/goose 3 kg		-	190-200	100 - 160	2
Baked fish/en papillote (fillet, whole)		Yes	170 - 190	30 - 50	2
Stuffed vegetables (tomatoes, courgettes, aubergines)		Yes	180-200	50 - 70	2
Toasted bread		-	250	2 - 6	5
Fish fillets/slices		-	230 - 250	20 - 30*	4 3
Sausages/kebabs/spare ribs/hamburgers		-	250	15 - 30*	5 4
Roast chicken 1-1.3 kg		Yes	200 - 220	55 - 70**	2 1
Roast beef rare 1 kg		Yes	200 - 210	35 - 50**	3
Leg of lamb/knuckle		Yes	200 - 210	60 - 90**	3
Roast potatoes		Yes	200 - 210	35 - 55**	3
Vegetable gratin		-	200 - 210	25 - 55	3
Meat and potatoes		Yes	190-200	45 - 100***	4 1
Fish and vegetables		Yes	180	30 - 50***	4 1
Lasagne and meat		Yes	200	50 - 100***	4 1
Complete meal: fruit tart (level 5)/ lasagne (level 3)/ meat (level 1)		Yes	180-190	40 - 120***	5 3 1
Roast meat/stuffed roasting joints		-	170 - 180	100 - 150	2

The time indicated does not include the preheating phase: we recommend placing the food in the oven and setting the cooking time only after the required temperature has been reached.

* Turn food halfway through cooking

** Turn food two thirds of the way through cooking (if necessary).

*** Estimated length of time: dishes can be removed from the oven at different times depending on personal preference.

Download the Use and Care Guide from www.hotpoint.eu for the table of tested recipes, compiled for the certification authorities in accordance with the standard IEC 60350-1.

FUNCTIONS								
	Conventional	Grill	Turbo Grill	Pizza	Forced Air	Maxi Cooking	Bread Auto	Eco Forced Air
ACCESSORIES								
	Wire shelf	Baking dish or baking tray on the wire shelf	Drip tray/baking tray on the wire shelf	Drip tray	Drip tray with 200 ml of water	Baking tray		

MAINTENANCE AND CLEANING



Download the Use and Care Guide from www.hotpoint.eu for more information

Do not use steam cleaning equipment.

Use protective gloves during all operations.

Carry out the required operations with the oven cold.

Disconnect the appliance from the power supply.



Do not use wire wool, abrasive scourers or abrasive/corrosive cleaning agents, as these could damage the surfaces of the appliance.

EXTERIOR SURFACES

- Clean the surfaces with a damp microfibre cloth. If they are very dirty, add a few drops of pH-neutral detergent. Finish off with a dry cloth.
- Do not use corrosive or abrasive detergents. If any of these products inadvertently comes into contact with the surfaces of the appliance, clean immediately with a damp microfibre cloth.

INTERIOR SURFACES

- After every use, leave the oven to cool and then clean it, preferably while it is still warm, to remove any deposits or stains caused by food residues. To dry any condensation that has formed as a result of cooking foods with a high water content, leave the oven to cool completely and then wipe it with a cloth or sponge.

- Activate the "Diamond Clean" function for optimum cleaning of the internal surfaces.
- The door can be easily removed and refitted to facilitate cleaning of the glass .
- Clean the glass in the door with a suitable liquid detergent.
- The top heating element of the grill can be lowered to clean the upper panel of the oven .

ACCESSORIES

Soak the accessories in a washing-up liquid solution after use, handling them with oven gloves if they are still hot. Food residues can be removed using a washing-up brush or a sponge.

REMOVING AND REFITTING THE DOOR

1. To remove the door, open it fully and lower the catches until they are in the unlock position.

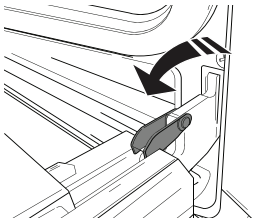

2. Close the door as much as you can. Take a firm hold of the door with both hands – do not hold it by the handle. Simply remove the door by continuing to close it while pulling it upwards (a) at the same time until it is released from its seating (b).

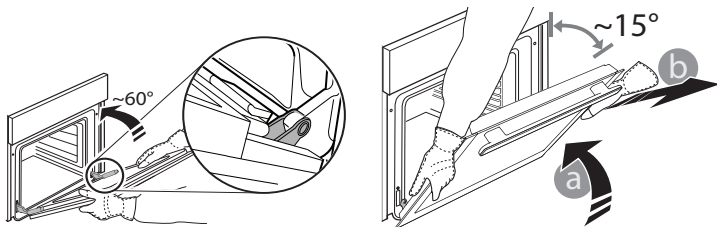

Put the door to one side, resting it on a soft surface.

3. Refit the door by moving it towards the oven, aligning the hooks of the hinges with their seating and securing the upper part onto its seating.

4. Lower the door and then open it fully. Lower the catches into their original position: make sure that you lower them down completely.

5. Try closing the door and check to make sure that it lines up with the control panel. If it does not, repeat the steps above.

CLICK TO CLEAN - CLEANING THE GLASS

1. After removing the door and resting it on a soft surface with the handle downwards, simultaneously press the two retaining clips and remove the upper edge of the door by pulling it towards you.

2. Lift and firmly hold the inner glass with both hands, remove it and place it on a soft surface before cleaning it.

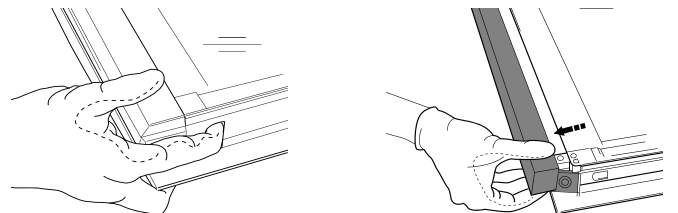

3. To correctly reposition the inner glass, make sure that the "R" is visible in the left-hand corner and the clear surface (not printed) is facing up. First insert the long side of the glass indicated by "R" into the support seats, then lower it into position.

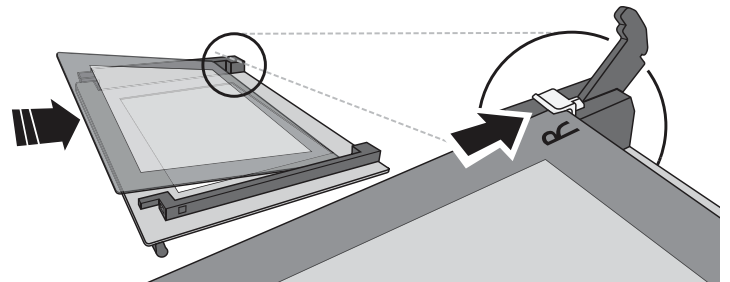

4. Refit the upper edge: a click will indicate correct positioning. Make sure the seal is secure before refitting the door.

Problem	Possible cause	Solution
The oven does not work	Power cut Disconnection from the mains	Check for the presence of mains electrical power and whether the oven is connected to the electricity supply. Turn off the oven and restart it to see if the fault persists
The display shows the letter "F" followed by a number	Software problem	Contact you nearest After-sales Service Centre and state the letter or number that follows the letter "F"
The display shows unclear text and appears to be broken.	Another language set.	Contact you nearest Client After-sales Service Centre.

USEFUL TIPS



Download the Use and Care Guide from www.hotpoint.eu for more information

HOW TO READ THE COOKING TABLE

The table lists the best function, accessories and level to use to cook various different types of food. Cooking times start from the moment food is placed in the oven, excluding preheating (where required). Cooking temperatures and times are approximate and depend on the amount of food and the type of accessory used. Use the lowest recommended settings to begin with and, if the food is not cooked enough, then switch to higher settings. Use the accessories supplied and preferably dark-coloured metal cake tins and baking trays. You can also use Pyrex or stoneware pans and accessories, but bear in mind that cooking times will be slightly longer.

COOKING DIFFERENT FOODS AT THE SAME TIME

The "Forced Air" function enables you to cook different foods (such as fish and vegetables) on different shelves at the same time. Remove the food which requires a shorter cooking time and leave the food which requires a longer cooking time in the oven.

BREAD AUTO FUNCTION

For best results you should carefully follow the instructions, using the recipe for mixing 1000 g of dough: 600 g of flour, 360 g of water, 11 g of salt, 25 g of fresh yeast (or two packets of yeast powder).

For optimal rising, allow about 90 minutes at room temperature or 60 minutes in the oven using the "Proving" function.

Put the dough into the (cold) oven, pour 100 cc of cold drinking water on to the bottom of the oven and activate the "Bread Auto" function. After cooking, leave the dough to stand on a wire shelf until completely cooled.

PRODUCT FICHE

The product fiche with energy data of this appliance can be downloaded from the website www.hotpoint.eu

HOW TO OBTAIN THE USE AND CARE GUIDE

> Download the Use and Care Guide from our website www.hotpoint.eu (you can use this QR code), specifying the product's commercial code.



> Alternatively, contact our After-sales Service

CONTACTING OUR AFTER-SALES SERVICE

You can find our contact details in the warranty manual. When contacting our Client After-sales Service, please state the codes provided on your product's identification plate.

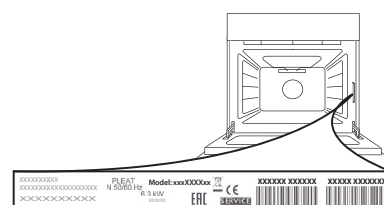

400011597418

Printed in Italy