

BTX2 PRO S/-LR



POCKET GUIDE



Frequenza: 2.4GHz - Potenza max: 100mW

ITALIANO



ON/OFF

DESCRIZIONE TASTI - LEGENDA

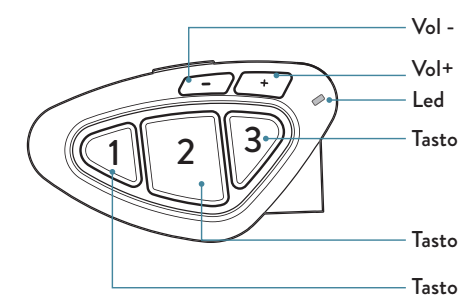

LEGENDA	
AZIONE	FEEDBACK VISIVO
Premere X secondi	Led blu lampeggia
Premere X volte	Led rosso lampeggia
	Led rosso/blu lampeggia
FEEDBACK SONORO	Led viola
Avviso sonoro	Led blu fisso
Avviso sonoro musicale	Led rosso fisso

ACCENSIONE

Premere 3 sec.	
	Lampeggia
	Avviso sonoro musicale
	Stato modo operativo
	Stato batteria

SPEGNIMENTO

Premere insieme 3 sec.	
	Lampeggia
	Avviso sonoro musicale

ABBINAMENTI

DESCRIZIONE ABBINAMENTI

Abbinamento stereo background (rimane in sottofondo all'intercom).
es. telefono con navigatore-TFT-GPS

Abbinamento prioritario stereo (interrompe l'intercom).
es. telefono-TFT

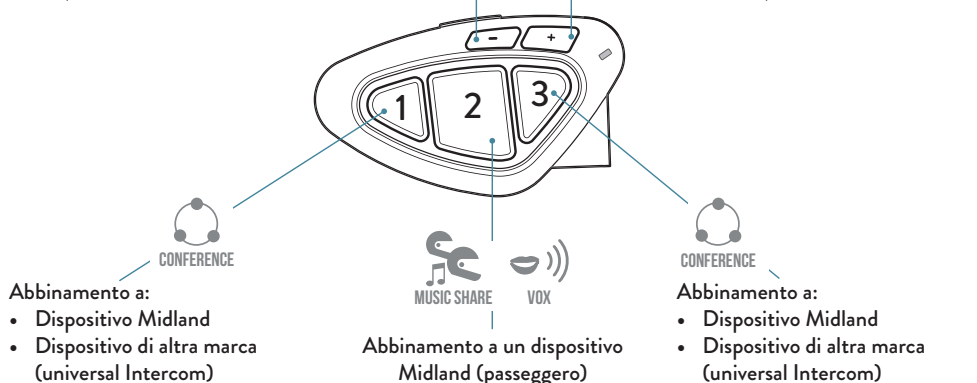

Abbinamento a:

- Dispositivo Midland
- Dispositivo di altra marca (universal Intercom)

Abbinamento a:

- Dispositivo Midland
- Dispositivo di altra marca (universal Intercom)

ENTRARE IN MODALITÀ IMPOSTAZIONI

Stato: dispositivo spento

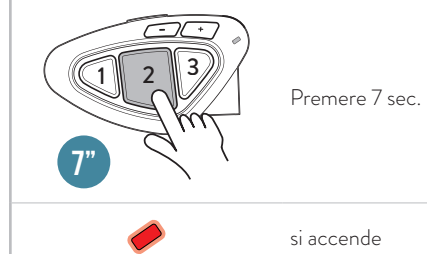

Premere 7 sec.

si accende

USCIRE DALLA MODALITÀ IMPOSTAZIONI / INTERRUPERE L'ABBINAMENTO

Stato: modalità impostazioni e durante l'abbinamento

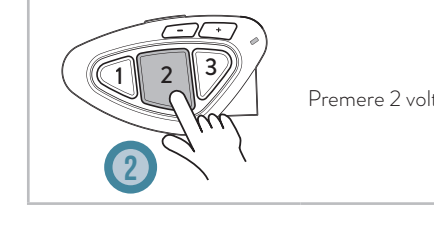

Premere 2 volte

RESET ABBINAMENTO

Stato: modalità impostazioni

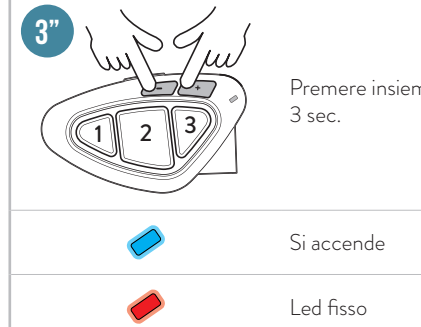

Premere insieme 3 sec.

Si accende

Led fisso

ABBINAMENTO CON INTERFONO MIDLAND

Stato: entrambi i dispositivi in modalità impostazioni



Premere 3 sec. (eseguire la procedura contemporaneamente su entrambi i dispositivi)

Lampeggia

Fisso 1 sec., abbinamento riuscito

Fisso, abbinamento completato

Nota: per abbinare altri dispositivi Midland, seguire la stessa procedura utilizzando i tasti 1 o 3.

ABBINAMENTO CON INTERFONO DI ALTRA MARCA

Stato: modalità impostazioni



Premere 7 sec. (eseguire la procedura contemporaneamente su entrambi i dispositivi)

Lampeggia veloce (tenere premuto)

Lampeggia lento, (rilasciare)

Fisso, abbinamento completato

2° Dispositivo



Seguire procedure di abbinamento per il telefono

Nota: se volete abbinare un secondo Universal Intercom, seguire la stessa procedura usando il Tasto 3.

ABBINAMENTO A 4 INTERFONI IN CONFERENCE

Stato: modalità impostazioni

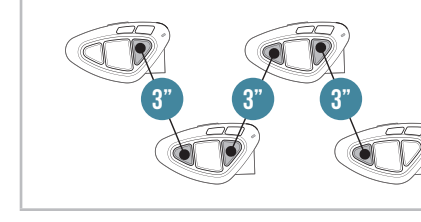

Nota: La modalità Conference permette la comunicazione contemporanea di più dispositivi. È necessario abbinare i dispositivi a "catena", ovvero il pulsante "Indietro" del primo dispositivo deve essere abbinato al pulsante "Avanti" del secondo, e così via. Per maggiori dettagli consultate il paragrafo "Conference" sul manuale d'uso.

ABBINAMENTO A UN TELEFONO/GPS

Stato: modalità impostazioni



Premere 3 sec.

lampeggia

seleziona il dispositivo sul telefono

Fisso 1 sec., abb. completato

Nota: il dispositivo abbinato su Vol- rimane in sottofondo rispetto all'Intercom. Per abbinare il dispositivo in priorità rispetto all'Intercom, ripetere la procedura utilizzando Volt+.

Per info visita:

<https://support.midlandeuropa.com/>

Seleziona un prodotto e:

Guarda i **video tutorial**

Scarica il **software**

Leggi il **manuale d'uso completo**

Scarica BTPRO SetAPP da App Store o Google Play

Midland World



Prodotto o importato da/Produced or imported by: Midland Europe srl - Via R. Sevardi 7 - 42124 Reggio Emilia - Italy. Prima dell'uso leggere attentamente le istruzioni. Read the instructions carefully before installation and use. Distributed by: MotoDirect Limited Company - Euro House, The Nursery, 1 Wincobank Way, South Normanton, Derbyshire. DE55 2FX UK. Read the instructions carefully before installation and use. Vertrieb durch: Alan Electronics GmbH Daimlerstrasse 1g-D-63303 Dreieich Deutschland. Vor Benutzung Bedienungsanleitung beachten. Importado por: Midland Iberia, SA C/Cobalt, 48 - 08940 Cornellà de Llobregat, Barcelona - España. Antes de utilizar, lea atentamente el manual de uso. Distribué par: Bih S.A.S. - www.bih.eu. Avant l'utilisation, lire les instructions.



MODALITÀ OPERATIVE

- A. Modalità Intercom:** per comunicare con un altro dispositivo.
 - B. Modalità telefono:** per chiamate telefoniche o per gestire la musica.
 - C. Modalità radio FM*:** per ascoltare, cercare e memorizzare stazioni radio.
- Nota: Le modalità Intercom e Telefono sono attive solo quando ci sono dei dispositivi abbinati.*

CAMBIARE MODALITÀ OPERATIVA

Stato: *dispositivo acceso*

3" Premere 3 sec.

Stato modalità operativa

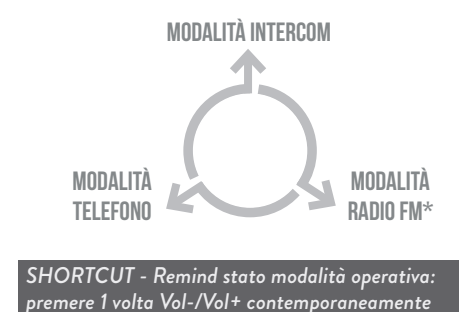

SHORTCUT - Remind stato modalità operativa: premere 1 volta Vol-/Vol+ contemporaneamente

A. MODALITÀ INTERCOM

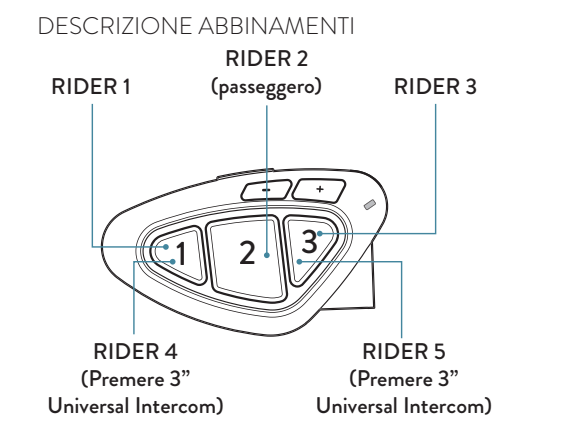

APRIRE/CHIUDERE INTERCOM MANUALMENTE

Stato: *modalità Intercom*

1 Premere 1 volta

Avviso sonoro

Lampeggia

Nota: Se avete abbinato un altro dispositivo, utilizzate i tasti 1 o 3 per aprire/chiudere l'intercom

APRIRE/CHIUDERE L'INTERCOM TRAMITE LA VOCE

Stato: *in tutte le modalità*

	Dire "Ciao"
	Avviso sonoro
	Lampeggia
	In silenzio per 40 sec. l'intercom si chiude
	Avviso sonoro

ATTIVARE/DISATTIVARE IL VOX

Stato: *in tutte le modalità*

	Premere 7 sec.
	Avviso sonoro

APRIRE/CHIUDERE UNIVERSAL INTERCOM

Stato: *Modalità Intercom*

	Premere 3 sec. apre Universal Intercom
	Lampeggia
	Avviso sonoro
	Premere 1 volta per chiudere Universal Intercom

Nota: Per aprire/chiudere l'audio da un dispositivo di altra marca, utilizzare il comando di chiamata vocale (per alcuni modelli è necessario inviare la chiamata vocale due volte).

Nota: Se avete un 2° dispositivo Universal Intercom, seguite la stessa procedura utilizzando il tasto 3.

SHORTCUT - Aprire l'Intercom del passeggero durante l'ascolto/condivisione della musica in modalità telefono: premere 2 volte Tasto 2

ATTIVARE/DISATTIVARE CONFERENCE

Stato: *in tutte le modalità*

	Premere 3 sec. contemporaneamente, attiva/disattiva Conference
	Avviso sonoro
	Stato connessioni

APRIRE/CHIUDERE CONFERENCE

Stato: *in Conference*

	Premere 1 volta Apri/chiude Conference con dispositivo abbinato al Tasto 1
	Premere 1 volta Apri Conference con tutti i dispositivi abbinati
	Premere 1 volta Apri/chiude Conference con dispositivo abbinato al Tasto 3

Nota: Durante la Conference, il dispositivo abbinato a Vol+ è momentaneamente scollegato, mentre rimane attivo quello abbinato a Vol-.

B. MODALITÀ TELEFONO

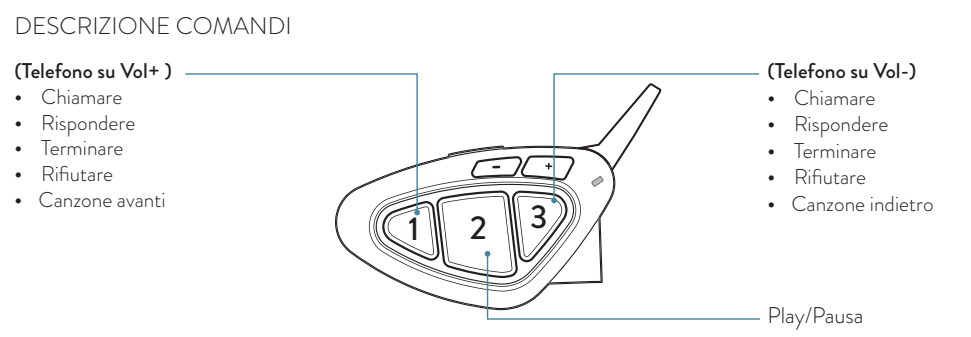

EFFETTUARE UNA CHIAMATA

Stato: *modalità Telefono*

	Premere 1 volta
	Risposta Assistente vocale (Google assistant, Siri)
	Dare istruzioni
	Avvio chiamata

RISPONDERE/TERMINARE UNA CHIAMATA

Premere 1 volta

RIFIUTARE UNA CHIAMATA

Premere 3 sec.

Nota: Se avete un telefono abbinato al tasto VOL+, utilizzate il tasto 1.

MUSICA

Stato: *modalità Telefono*

	Selezionare App musica
	Premere 1 volta Play/Pausa
	Premere 1 volta Avanti brano
	1 Premere 1 volta Indietro brano
	3" Premere 3 sec. Attivare/Interrompere Condivisione musica con passeggero (Music Share)

SHORTCUT - Play/Pausa della musica in modalità Intercom/radio FM: premere 2 volte Tasto 2

CONTROLLO MUSICA VOL+/VOL-

Stato: *in tutte le modalità*

	Premere 3 sec.
	Controllo Vol+/Vol-

Nota: In caso di due dispositivi Multimediali abbinati, per gestire la musica del dispositivo abbinato su Vol- dovrete settare il "controllo musica" su Vol-, mentre per gestire la musica del dispositivo abbinato sul Vol+ dovrete settare il "controllo musica" su Vol+

ATTIVAZIONE PUBLIC/PRIVATE

Stato: *in tutte le modalità*

	Premere 3 sec.
	Private Public

Con l'attivazione di Public si condividono in intercom le info vocali provenienti dal dispositivo abbinato a Vol-. **Le telefonate sono sempre private.**

C. MODALITÀ RADIO FM*



RADIO FM

Stato: *modalità Radio FM*

	Premere 1 volta On/Off
	1 Stazione avanti
	3" Memoria avanti
	1 Stazione indietro
	3" Memoria indietro

* Solo per versioni dotate di Radio FM.

BTX2 PRO S/-LR



POCKET GUIDE



Frequency: 2.4GHz - Max power: 100mW

ENGLISH



ON/OFF

CONTROLS DESCRIPTION - LEGENDA

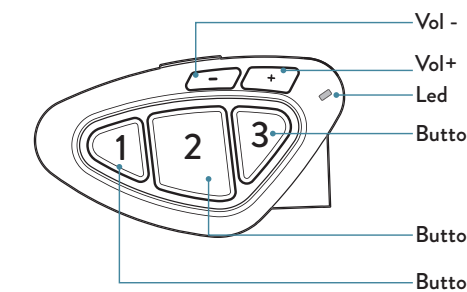

LEGENDA	
OPERATION	VISUAL FEEDBACK
Press X seconds	Blue led blinking
Press x times	Red led blinking
AUDIO FEEDBACK	Red/blue led blinking
Sound alert	Purple led
Musical sound alert	Steady blue led
	Steady red led

POWER ON

Press 3 seconds	
	Blinking
	Musical sound alert
	Operating mode status
	Battery status

POWER OFF

Press 3 seconds at the same time	
	Blinking
	Musical sound alert

PAIRING

PAIRING DESCRIPTION

Stereo background pairing (in background to the intercom)
Ex.: phone with navigator-TFT-GPS

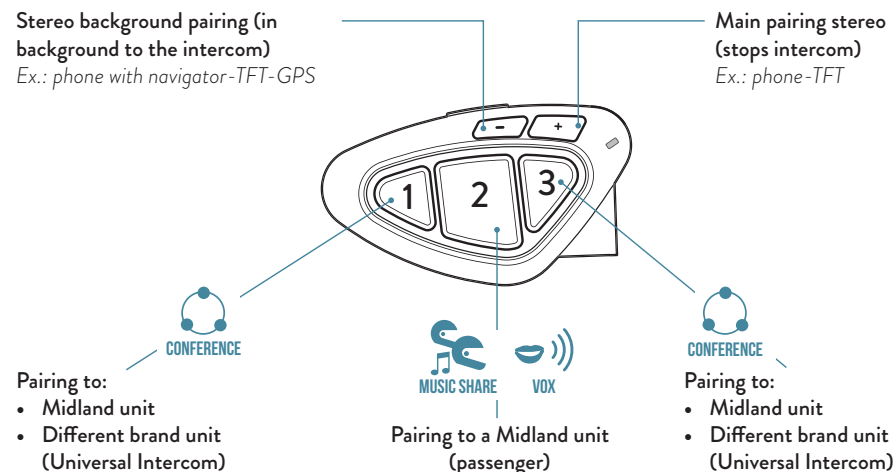

Pairing to:

- Midland unit
- Different brand unit (Universal Intercom)

Pairing to:

- Midland unit
- Different brand unit (Universal Intercom)

TO ENTER SETUP MODE

Status: Power off	
Press 7 seconds	
	Lights up

TO EXIT SETUP MODE/INTERRUPT THE PAIRING

Status: Setup mode and during pairing	
Press twice	

TO RESET THE PAIRING

Status: Setup mode	
Press 3 seconds at the same time	
	Lights up
	Steady led

PAIRING TO A MIDLAND UNIT

Status: Both units in setup mode	
Press 3 seconds (start procedure on both units at the same time)	
	Blinking
	Steady 1 second, pairing successful
	Steady, pairing complete

Note: To pair other Midland units, follow the same procedure but press buttons 1 or 3.

PAIRING TO A DIFFERENT BRAND UNIT

Status: Setup mode	
1st Unit	
Press 7 seconds (start procedure on both units at the same time)	
	Blinking fast (keep pressed)
	Blinking slowly (release)
	Steady, pairing complete
2nd Unit	
	Follow the "phone" pairing procedure

Note: to pair another Universal Intercom, follow the same procedure but press Button 3.

PAIRING 4 UNITS IN CONFERENCE

Status: Setup mode	
Press 3 seconds	

Note: the Conference mode allows the simultaneous communication amongst units. All units must be paired in a "chain" configuration: the Backwards button of the first unit must be paired to the Forwards button of the second unit and so on. For a detailed description of the function go to paragraph "Conference" of the complete user manual.

PAIRING TO A PHONE/GPS

Status: Setup mode	
Press 3 seconds	
	Blinking
	Select device on the phone
	Steady 1 second, pairing successful

Note: the unit paired to Vol- is in background to the intercom. To pair the unit and interrupt the intercom, repeat the procedure but press Vol+.

For more info visit:
<https://support.midlandeuropa.com/>

Select a product and:
Watch **tutorial video**
Download **software**
Read complete **manual instruction**

Download **BTPRO SetAPP** from
App Store or Google Play

Midland World



Prodotto o importato da/Produced or imported by: Midland Europe srl - Via R. Sevardi 7 - 42124 Reggio Emilia - Italy. Prima dell'uso leggere attentamente le istruzioni. Read the instructions carefully before installation and use. **Distributed by: MotoDirect Limited Company** - Euro House, The Nursery, 1 Wincobank Way, South Normanton, Derbyshire. DE55 2FX UK. Read the instructions carefully before installation and use. **Vertrieb durch: Alan Electronics GmbH** Daimlerstrasse 1g-D-63303 Dreieich Deutschland. Vor Benutzung Bedienungsanleitung beachten. **Importado por: Midland Iberia, SA** C/Cobalt, 48 - 08940 Cornellà de Llobregat, Barcelona - España. Antes de utilizar, lea atentamente el manual de uso. **Distribué par: Bih S.A.S.** - www.bih.eu. Avant l'utilisation, lire les instructions.



OPERATING MODES

A. Intercom mode: to talk to another unit.

B. Phone mode: phone calls or manage music.

C. FM radio mode*: to listen to, seek and store FM radio stations.

Note: Intercom and phone modes are possible only when the units are paired.

TO CHANGE THE OPERATING MODE

Status: Power on



Operating mode status

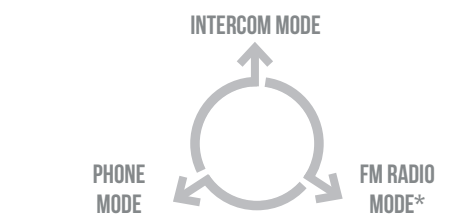

SHORTCUT - Remind - Operating mode status: Press Vol-/Vol+ at the same time.

A. INTERCOM MODE

PAIRING DESCRIPTION

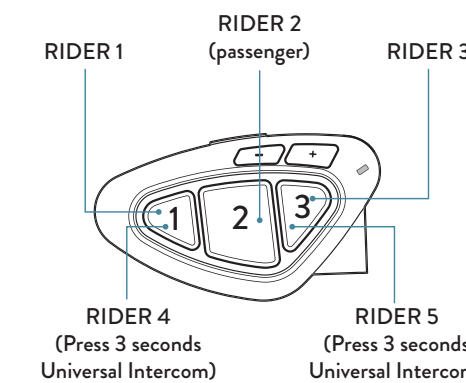

TO OPEN/CLOSE INTERCOM MANUALLY

Status: Intercom mode

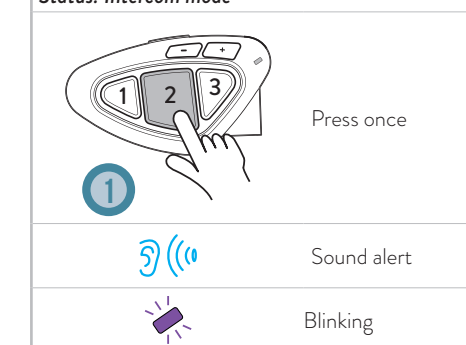

Note: if you have paired another unit, push buttons 1 or 3 to open/close the intercom.

TO OPEN/CLOSE INTERCOM USING THE VOICE

Status: All modes

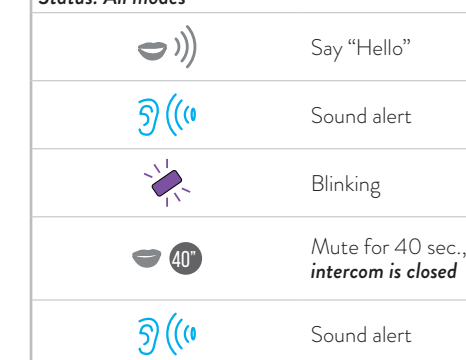

Note: the voice activation is possible only if the unit is paired to button 2.

ENABLING/DISABLING VOX

Status: All modes

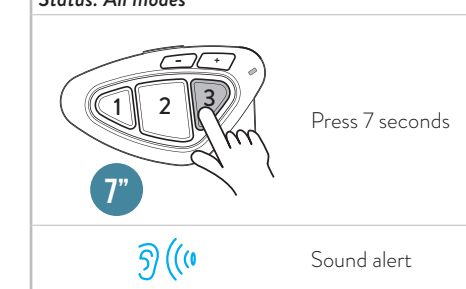

TO OPEN/CLOSE UNIVERSAL INTERCOM

Status: Intercom mode

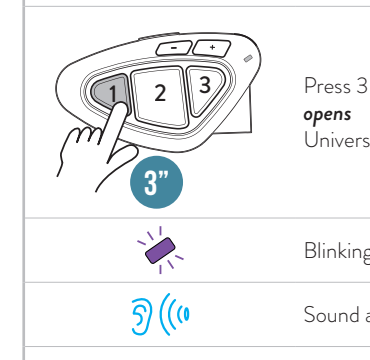

Note: to open/close the audio from a different brand unit, use the voice dial command (for some models you have to send the command twice).

Note: if you have another device as Universal Intercom, follow the same procedure but press button 3.

SHORTCUT - To open the intercom while listening to/sharing music in phone mode: press button 2 twice.

TO ENABLE/DISABLE CONFERENCE

Status: All modes

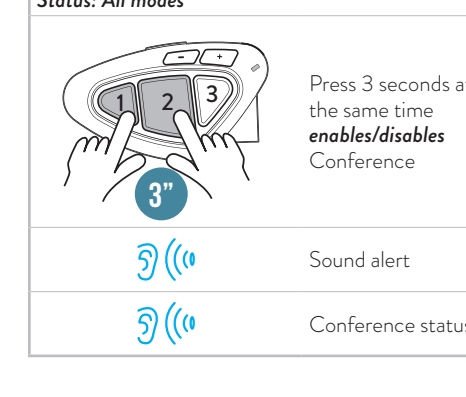

TO OPEN/CLOSE CONFERENCE

Status: Conference

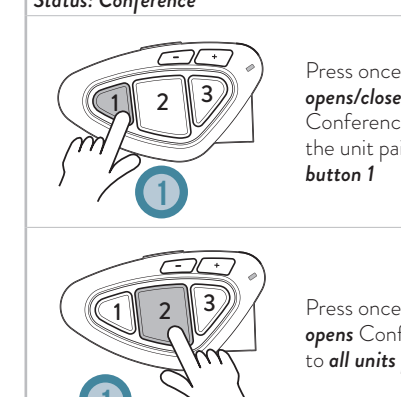

Note: The device paired to Vol+ is temporary disconnected, while the one paired to Vol- is still active.

B. PHONE MODE

CONTROLS DESCRIPTIONS

(Phone paired on Vol+)

- Make a call
- Answer a call
- End a call
- Reject a call
- Song forward



Play/pause

- Make a call
- Answer a call
- End a call
- Reject a call
- Song backward



Play/pause

- Make a call
- Answer a call
- End a call
- Reject a call
- Song backward



Play/pause

Note: if your phone is paired to Vol+, press button 1.

TO MAKE A CALL

Status: phone mode

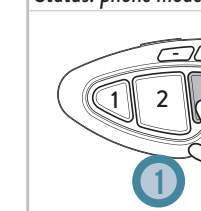

Voice assistant (Google assistant, Siri)

Give instructions to your assistant

Call starts

ANSWER/END A CALL

Status: phone mode



Reject a call

Press 3 seconds

MUSIC

Status: phone mode

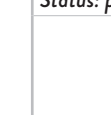

Press once Play/Pause



Press once Song forward



Press once Song backward



Press 3 seconds activates/interrupts music sharing with passenger (Music Share)



Private Public

SHORTCUT - Music Play/pause in Intercom/FM radio mode: press twice button 2.

C. FM RADIO MODE*

CONTROLS DESCRIPTION

Radio station up Memory up

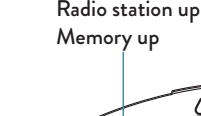

Radio station down Memory down



FM radio On/Off



Radio station up



Memory up



Radio station down



Memory down

*** Only for versions supplied with FM Radio.**

FM RADIO

Status: FM Radio mode



Radio station up



Radio station down



Memory down

BTX2 PRO S/-LR



KURZANLEITUNG



Frequenz: 2.4GHz - Max Power: 100mW

DEUTSCH



EIN/AUS

TASTEN BESCHREIBUNG

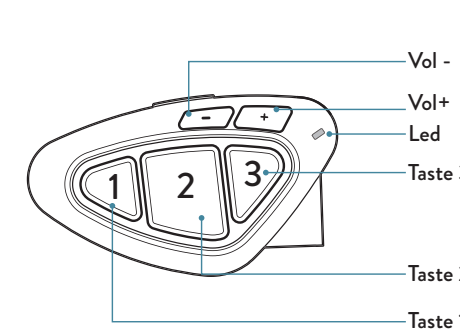

ÜBERSICHT

BETRIEB



X Sekunden drücken



X mal drücken

SOUNDS



Ansage bzw. Ton



Melodie

LED ANZEIGE



Blau blinkend



Rot blinkend



Blau/Rot blinkend



Lila blinkend



Blau leuchtend



Rot leuchtend

EINSCHALTEN

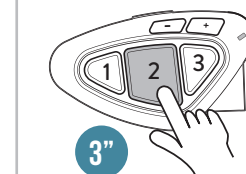

3 Sekunden drücken



Blau blinkend



Melodie



Ansage Modus



Ansage Batteriestand

AUSSCHALTEN

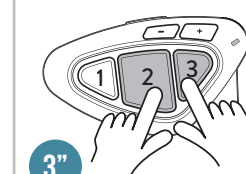

Taste 2 und 3 gleichzeitig für 3 Sekunden drücken



Rot blinkend



Melodie

KOPPELN

BESCHREIBUNG

Stereo Hintergrund (im Hintergrund vom Intercom)
Bsp.: Telefon mit Navigationsgerät



Gekoppelt zu:

- Midland Gerät
- Gerät andere Marke (Universal Intercom)

Stereo Kopplung (stoppt das Intercom)
Bsp.: Telefon - MP3 Player

Gekoppelt zu:

- Midland Gerät
- Gerät andere Marke (Universal Intercom)

SETUP MODUS

Status: Ausgeschaltet



Taste 2 für 7 Sekunden drücken



Rote LED

SETUP MODUS BEENDEN KOPPLUNG UNTERBRECHEN

Status: Setup Modus und während Kopplungsvorgang

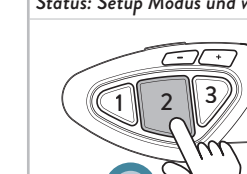

Taste 2 zweimal drücken



Blau leuchtend, Kopplung abgeschlossen

KOPPLUNG ZURÜCKSETZEN

Status: Setup Modus

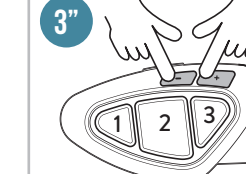

Taste Vol+ und - gleichzeitig für 3 Sekunden drücken



Blau leuchtet kurz auf



Rot leuchtend

KOPPLUNG MIT EINEM MIDLAND GERÄT

Status: Beide Geräte im Setup Modus

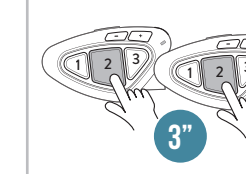

7 Sekunden drücken (Prozedur an beiden Geräten gleichzeitig starten)



Schnell blinkend



Leuchtet 1 Sek. Blau, Kopplung erfolgreich



Leuchtet Rot, Kopplung abgeschlossen

Hinweis: um ein weiteres Midland Gerät zu koppeln, wiederholen Sie die Prozedur mit Taste 1 oder 3.

KOPPLUNG ZU EINEM GERÄT VON EINEM ANDEREN HERSTELLER

Status: Setup Modus

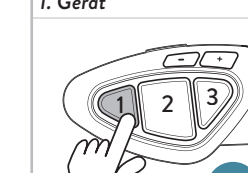

7 Sekunden drücken (Prozedur an beiden Geräten gleichzeitig starten)



Schnell blinkend (gedrückt halten)



Langsam blinkend (Tasten loslassen)



Blau leuchtend, Kopplung erfolgreich

2. Gerät



Folgen Sie der "Telefon" Kopplungsanleitung

Hinweis: um ein weiteres Universal Intercom zu koppeln, führen Sie die Prozedur mit der Taste 3 durch.

4 GERÄTE IN KONFERENZ VERBINDEN

Status: Setup Modus

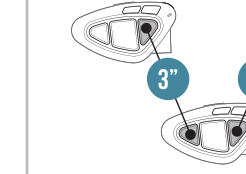

Hinweis: der Konferenzmodus erlaubt die gleichzeitige Kommunikation aller Geräte. Die Geräte werden als "Kette" verbunden: die Zurück-Taste des 1. Gerätes muss mit der Vorwärts-Taste des 2. Gerätes usw. gekoppelt sein. Für eine ausführliche Beschreibung schauen Sie in der Gesamtleitung im Kapitel "Konferenz" nach.

VERBINDUNG ZUM TELEFON/NAVI

Status: Setup Modus



Vol- 3 Sekunden drücken



Blau/Rot blinkend



Geräte auf Telefon auswählen



Blau leuchtet 1 Sek. Kopplung erfolgreich

Hinweis: Geräte die über Vol- gekoppelt werden, arbeiten im Hintergrund zum Intercom. Soll die Priorität höher sein und das Intercom unterbrechen, koppeln Sie das Gerät auf Vol+.

Für mehr Informationen:

<https://support.midlandeuropa.com/>

Wählen Sie ein Produkt aus und:

Schauen Sie das **Tutorial Video**

Download **Software**

Lesen Sie die **Gesamtleitung**

Download **BTPRO SetAPP** aus **App Store** oder **Google Play**

Midland World



Prodotto o importato da/Produced or imported by: Midland Europe srl - Via R. Sevardi 7 - 42124 Reggio Emilia - Italy. Prima dell'uso leggere attentamente le istruzioni. Read the instructions carefully before installation and use. Distributed by: MotoDirect Limited Company - Euro House, The Nursery, 1 Wincobank Way, South Normanton, Derbyshire. DE55 2FX UK. Read the instructions carefully before installation and use. Vertrieb durch: Alan Electronics GmbH Daimlerstrasse 1g-D-63303 Dreieich Deutschland. Vor Benutzung Bedienungsanleitung beachten. Importado por: Midland Iberia, SA C/Cobalt, 48 - 08940 Cornellà de Llobregat, Barcelona - España. Antes de utilizar, lea atentamente el manual de uso. Distribué par: Bihr S.A.S. - www.bihr.eu. Avant l'utilisation, lire les instructions.



BETRIEBSMODI

- A. **Intercom Modus:** Gegensprechen.
- B. **Telefon Modus:** Telefongespräche oder Musik.
- C. **UKW Radio Modus*:** Radio hören.

Hinweis: Intercom und Telefon Modus funktionieren nur, wenn mind. 2 Geräte gekoppelt sind.

BETRIEBSMODUS ÄNDERN

Status: **Gerät eingeschaltet**



Ansage des Betriebsmodus

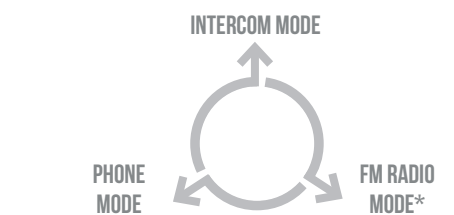

KURZWAHL - Ansage des aktuellen Betriebsmodus: Drücken Sie Vol-/Vol+ gleichzeitig.

A. INTERCOM MODUS

KOPPLUNGS ANLEITUNG

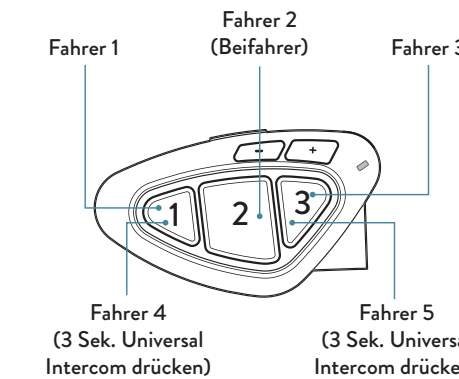

INTERCOM MANUELL ÖFFNEN/SCHLIESSEN

Status: **Intercom Modus**



Hinweis: wenn Sie weitere Geräte gekoppelt haben, drücken Sie entsprechend die Tasten 1/3.

INTERCOM PER SPRACHBEFEHL ÖFFNEN/SCHLIESSEN

Status: **Alle Modi**

	Sagen Sie "Hello"
	Tonsignal
	Lila blinkend
	Intercom schließt nach 40Sek. ohne Sprache
	Tonsignal

Hinweis: die Sprachsteuerung ist nur möglich, wenn das Geräte über Taste 2 gekoppelt ist.

VOX EIN-/AUSSCHALTEN

Status: **Alle Modi**



UNIVERSAL INTERCOM ÖFFNEN/SCHLIESSEN

Status: **Intercom Modus**

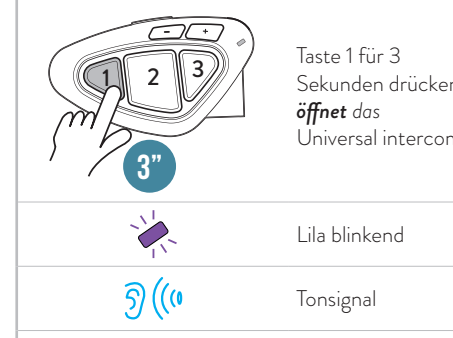

Hinweis: um die Audioverbindung vom Fremdgerät zu öffnen, drücken Sie die Sprachwahl-taste (bei einigen Modellen muss der Befehl zweimal gesendet werden)

Hinweis: um ein weiteres Universal Intercom zu koppeln, führen Sie die Prozedur mit der Taste 3 durch.

KURZWAHL - Um das Intercom während der Musikwiedergabe zu öffnen, drücken Sie die Taste 2 zweimal.

KONFERENZ EIN-/AUSSCHALTEN

Status: **Alle Modi**

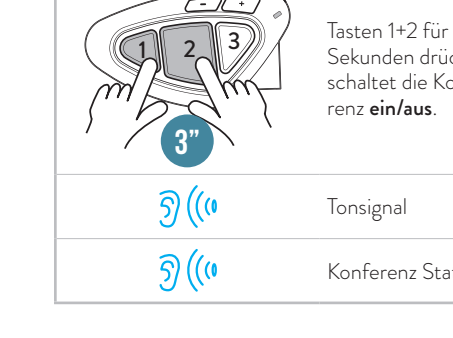

KONFERENZ ÖFFNEN/SCHLIESSEN

Status: **Konferenz**

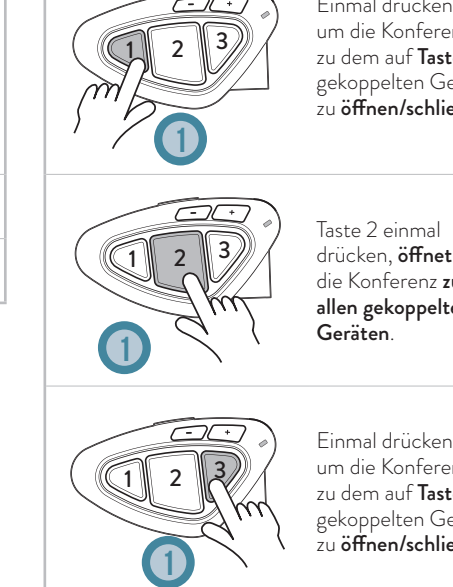

Hinweis: Das Gerät auf Vol+ ist während der Konferenz deaktiviert, während das Gerät auf Vol- immernoch aktiv ist.

B. TELEFON MODUS

TASTENBESCHREIBUNG

(Telefon auf Vol+ gekoppelt)

- Anruf tätigen
- Anruf annehmen
- Anruf beenden
- Anruf ablehnen
- nächster Musiktitel

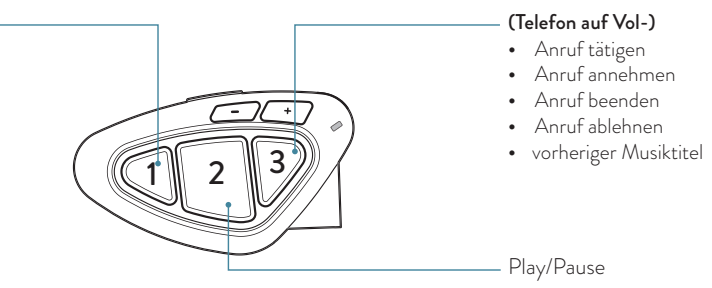

TELEFONANRUF TÄTIGEN

Status: **Telefon Modus**

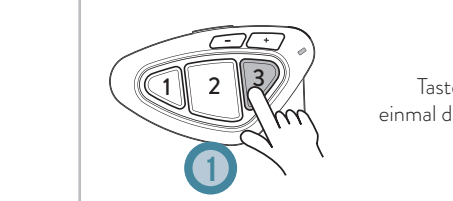

Sprachassistent (OK Google, Siri)

Sagen Sie ihren Befehl

Anruf startet

ANRUF ANNEHMEN/BEENDEN

Status: **Telefon Modus**



ANRUF ABLEHNEN



MUSIK

Status: **Telefon Modus**

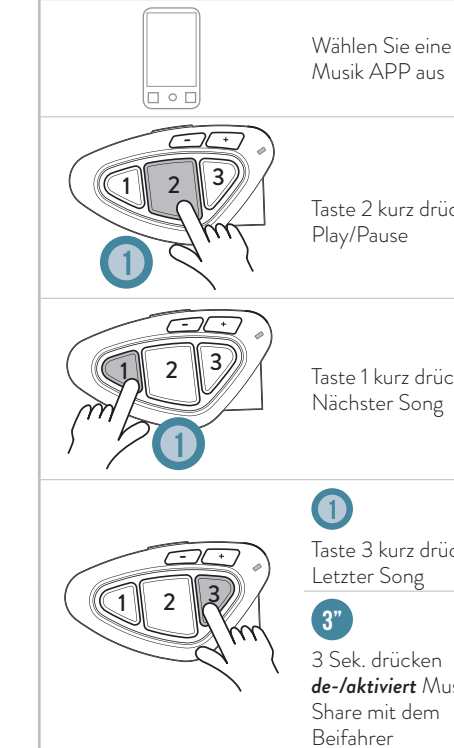

KURZWAHL - Musik Play/pause im Intercom/UKW Radio Modus: Doppelklick auf Taste 2.

FERNSTEUERUNG DER LAUTSTÄRKE VOL+/VOL-

Status: **Alle Modi**

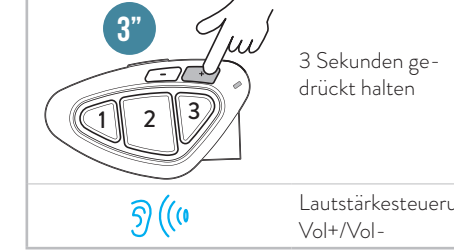

Hinweis: wenn zwei Multimediageräte gekoppelt sind, wird die Lautstärke des über Vol+ gekoppelten Gerätes gesteuert, indem die Vol+-Taste gehalten wird. Soll das andere Gerät gesteuert werden, muss die Vol--Taste gehalten werden.

PRIVATER/ÖFFENTLICHER MODUS

Status: **Alle Modi**

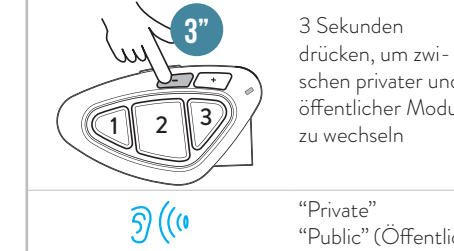

Wenn Sie im öffentlichen Modus sind, können Sie das Intercom auf Vol- teilen.
Telefonanrufe sind immer privat.

C. UKW RADIO MODUS*

TASTEN BESCHREIBUNG

Radio Suchlauf aufwärts nächster Speicherplatz

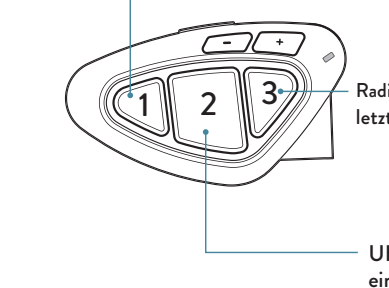

Radio Suchlauf aufwärts

nächster Speicherplatz

Radio Suchlauf runter

vorheriger Speicherplatz

* Nur für Versionen mit FM-Radio.

BTX2 PRO S/-LR



POCKET GUIDE



Frecuencia: 2.4GHz - Potencia máx.: 100mW

ESPAÑOL



ON/OFF

DESCRIPCIÓN TECLAS - LEYENDA

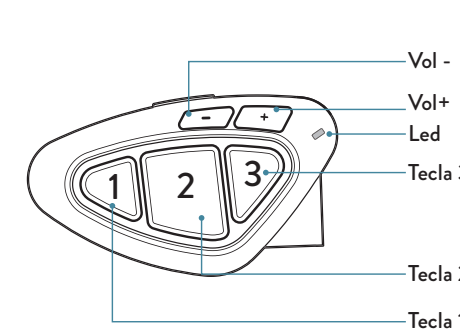

LEYENDA	
OPERACIÓN	FEEDBACK VISUAL
Pulsar X segundos	Led azul parpadea
Pulsar X veces	Led rojo parpadea
FEEDBACK SONORO	Led rojo/azul parpadea
Alerta sonora	Led violeta
Alerta sonora musical	Led azul encendido
	Led rojo encendido

ENCENDER

Pulsar 3 seg.	
Parpadea	
Alerta sonora musical	
Estado modo operativo	
Estado batería	

APAGAR

Pulsar 3 seg. a la vez	
Parpadea	
Alerta sonora musical	

EMPAREJAMIENTO

DESCRIPCIÓN DE LOS EMPAREJAMIENTOS

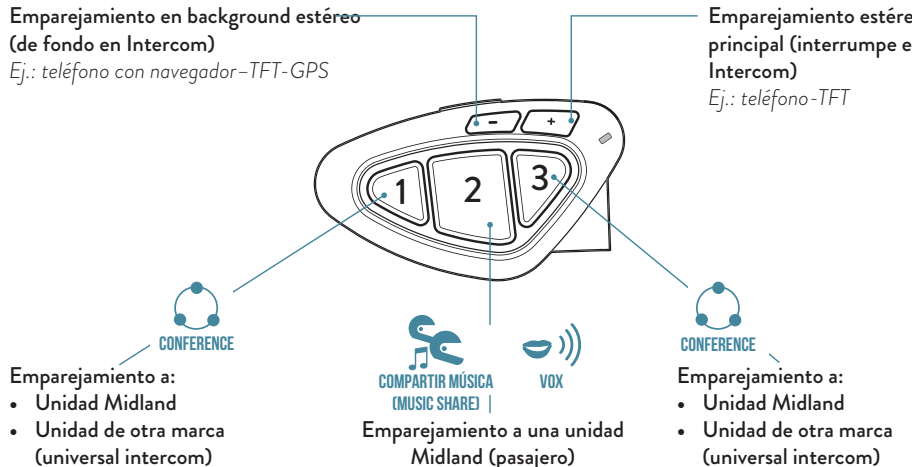

ENTRAR AL MODO CONFIGURACIÓN

Estado: unidad apagada	
Pulsar 7 seg.	
Encendido	

SALIR DEL MODO CONFIGURACIÓN/ INTERRUPTIR EL EMPAREJAMIENTO

Estado: modo configuración y durante el emparejamiento	
Pulsar 2 veces	

RESET DE LOS EMPAREJAMIENTOS

Estado: modo configuración	
Pulsar 3 seg. a la vez	
Se enciende	
Led rojo encendido	

EMPAREJAMIENTO A UNA UNIDAD MIDLAND

Estado: las dos unidades en modo configuración	
Pulsar 3 seg. (proceder igual en las dos unidades).	
Parpadea	
Led azul encendido 1 seg., emparejamiento exitoso	
Led rojo fijo, emparejamiento terminado	

Nota: para emparejar otras unidades Midland, seguir el mismo proceso, pero pulsar las teclas 1 o 3.

EMPAREJAMIENTO CON UNA UNIDAD DE OTRA MARCA

Estado: modo configuración	
1ª unidad	
Pulsar 7 seg. (proceder igual en las dos unidades).	
Parpadea rápido (mantener pulsado)	
Parpadea lento (soltar)	
Led fijo, emparejamiento terminado	
2ª unidad	
Seguir el proceso para emparejar un teléfono	

Nota: para emparejar otro Universal Intercom, seguir el mismo proceso pero pulsando la tecla 3.

EMPAREJAMIENTO CON 4 UNIDADES EN CONFERENCIA

Estado: modo configuración	

Nota: el modo "Conferencia" permite la comunicación simultánea de varios dispositivos. Para usar dicha función, los dispositivos deben estar enlazados en modo "cadena": enlazar el botón "Atrás" del primer BTX2 PRO S al botón "Adelante" del segundo BTX2 PRO S, y así sucesivamente. Para más información, ver el párrafo "Conferencia" del manual de usuario.

ENLAZAR A UN TELÉFONO/GPS

Estado: modo configuración	
Pulsar 3 seg.	
Parpadea	
Seleccionar la unidad en el teléfono	
Encendido 1 seg., emparejamiento terminado	

Nota: la unidad emparejada a Vol- está en segundo plano respecto al Intercom. Para emparejar la unidad e interrumpir el intercom, seguir el proceso pero pulsando el botón Vol+.

Para más información:
<https://support.midlandeuropa.com/>

Seleccionar un producto y:
Ver el **videotutorial**
Descargar el **software**
Leer el **manual de usuario completo**

Descargar **BTPRO SetAPP** desde
App Store o Google Play

Midland World



Prodotto o importato da/Produced or imported by: Midland Europe srl - Via R. Sevardi 7 - 42124 Reggio Emilia - Italy. Prima dell'uso leggere attentamente le istruzioni. Read the instructions carefully before installation and use. **Distributed by: MotoDirect Limited Company** - Euro House, The Nursery, 1 Wincobank Way, South Normanton, Derbyshire. DE55 2FX UK. Read the instructions carefully before installation and use. **Vertrieb durch: Alan Electronics GmbH** Daimlerstrasse 1g-D-63303 Dreieich Deutschland. Vor Benutzung Bedienungsanleitung beachten. **Importado por: Midland Iberia, SA** C/Cobalt, 48 - 08940 Cornellà de Llobregat, Barcelona - España. Antes de utilizar, lea atentamente el manual de uso. **Distribué par: Bih S.A.S.** - www.bih.eu. Avant l'utilisation, lire les instructions.



MODOS OPERATIVOS

A. Modo Intercom: para hablar con otra unidad.

B. Modo teléfono: para llamadas y para gestionar la música.

C. Modo radio FM*: para escuchar, buscar y memorizar estaciones de radio FM.

Nota: los modos Intercom y Teléfono están activos solo si hay dispositivos emparejados.

CAMBIAR EL MODO OPERATIVO

Estado: unidad encendida

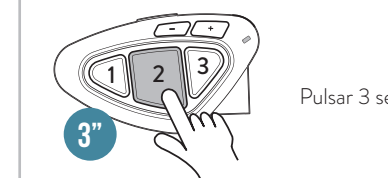

Pulsar 3 seg.



Estado modo operativo

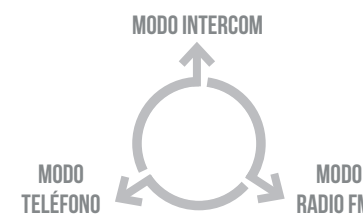

ATAJO - Estado del modo operativo:
Pulse Vol- / Vol+ al mismo tiempo.

A. MODO INTERCOM

DESCRIPCIÓN DE EMPAREJAMIENTOS



ABRIR/CERRAR EL INTERCOM MANUALMENTE

Estado: modo Intercom

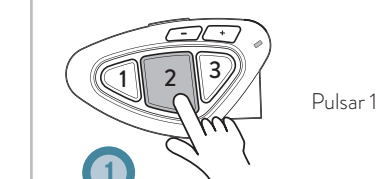

Pulsar 1 vez



Alerta sonora



Parpadea

Nota: si se ha emparejado otra unidad, pulsar las teclas 1 y 3 para abrir/cerrar el Intercom.

ABRIR/CERRAR EL INTERCOM CON LA VOZ

Estado: en todos los modos



Decir "Hola"



Alerta sonora



Parpadea



Silencio durante 40 seg.

el intercom se apaga



Alerta sonora

Nota: la activación vocal solo es posible con la unidad emparejada al botón 2.

ACTIVAR/DESACTIVAR EL VOX

Estado: en todos los modos



Pulsar 7 seg.

Nota: si se ha emparejado otra unidad, pulsar las teclas 1 y 3 para abrir/cerrar el Intercom.

ABRIR/CERRAR EL UNIVERSAL INTERCOM

Estado: modo Intercom



Pulsar 3 seg. para abrir Universal Intercom



Parpadea



Alerta sonora

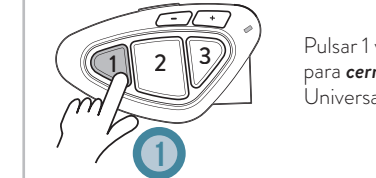

Pulsar 1 vez para cerrar Universal Intercom

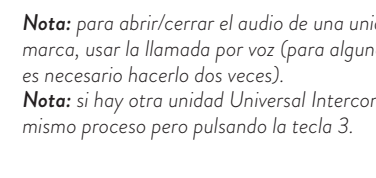

Pulsar 1 vez para cerrar Universal Intercom

Nota: para abrir/cerrar el audio de una unidad de otra marca, usar la llamada por voz (para algunos modelos es necesario hacerlo dos veces).

Nota: si hay otra unidad Universal Intercom, seguir el mismo proceso pero pulsando la tecla 3.

ATAJO - Para abrir el Intercom mientras escucha o comparte música en modo teléfono: pulsar 2 veces el botón 2.

ACTIVAR/DESACTIVAR CONFERENCIA

Estado: en todos los modos



Pulsar 3 seg. a la vez para activar/desactivar Conferencia



Alerta sonora



Estado Conferencia

ABRIR/CERRAR CONFERENCIA

Estado: Conferencia

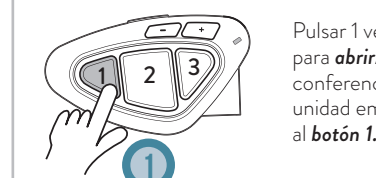

Pulsar 1 vez para abrir/cerrar conferencia a la unidad emparejada al botón 1.



Pulsar 1 vez para abrir la Conferencia a todas las unidades emparejadas.



Pulsar 1 vez para abrir/cerrar la Conferencia a la unidad emparejada al botón 3.

Nota: la unidad emparejada a Vol+ se desconecta momentáneamente, mientras que la emparejada a Vol- sigue activa.

B. MODO TELÉFONO

DESCRIPCIÓN DE LAS TECLAS

Teléfono enlazado a Vol+

- Realizar una llamada
- Responder una llamada
- Terminar una llamada
- Rechazar una llamada
- Avanzar canción

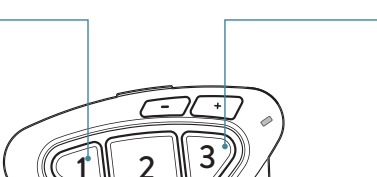

Teléfono enlazado a Vol-

- Realizar una llamada
- Responder una llamada
- Terminar una llamada
- Rechazar una llamada
- Canción anterior

Play/pausa

REALIZAR UNA LLAMADA

Estado: modo teléfono

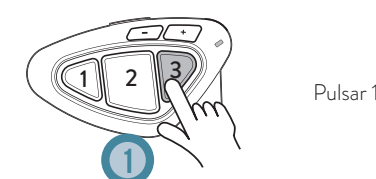

Pulsar 1 vez



Respuesta asistente de voz (Google Assistant, Siri)



Dar instrucciones al asistente



Empezar llamada

Nota: si hay un teléfono emparejado al botón Vol+, use la tecla 1.

ATENDER/TERMINAR UNA LLAMADA

Pulsar 1 vez



RECHAZAR UNA LLAMADA

Pulsar 3 seg.



MÚSICA

Estado: modo teléfono



Selección APP para la música



Pulsar 1 vez Play/Pausa



Pulsar 1 vez Avanzar canción



Pulsar 1 vez Canción anterior



Pulsar 3 seg. Activa/desactiva la compartición de música con el pasajero (Music share)

Atajo - Play/Pausa de la música en modo Intercom/ Radio FM: pulsar 2 veces la tecla 2.

CONTROL DE LA MÚSICA VOL+/VOL-

Estado: en todos los modos



Pulsar 3 seg.



Control Vol+/Vol-

Nota: si ha conectado dos dispositivos multimedia, para controlar la música del aparato emparejado a Vol- se debe configurar el control de la música en Vol-; y para controlar la música del aparato emparejado a Vol+ hay que configurar el control de la música en Vol+.

ACTIVAR PÚBLICO/PRIVADO

Estado: en todos los modos



Pulsar 3 seg.



Privado Público

Con la activación del modo Público todo el audio proveniente de la unidad emparejada a Vol- es compartido. Las llamadas son siempre privadas.

C. MODO RADIO FM*

DESCRIPCIÓN DE LAS TECLAS

Estación siguiente

Memoria siguiente

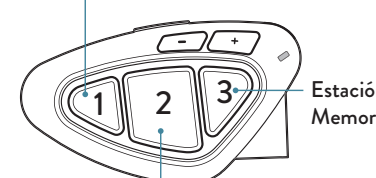

Estación anterior Memoria anterior

Radio FM On/Off

RADIO FM

Estado: modo Radio FM

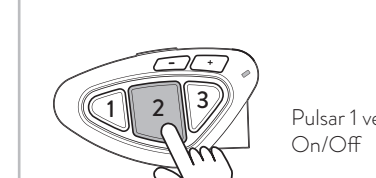

Pulsar 1 vez On/Off



Estación siguiente



Memoria siguiente



Estación anterior



Memoria anterior

*
Sólo para las versiones equipadas con radio FM.

BTX2 PRO S/-LR



POCKET GUIDE



Fréquence: 2.4GHz - Max puissance: 100mW

FRANÇAIS



ON/OFF

DESCRIPTION DES TOUCHES - LÉGENDE

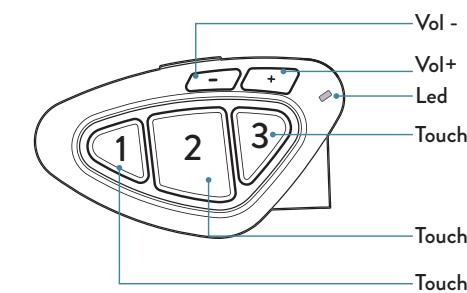

LÉGENDE	
OPÉRATION	RETOUR VISUEL
Appuyer X secondes	Led bleu clignotant
Appuyer X fois	Led rouge clignotant
RETOUR SONORE	Led rouge/bleu clignotant
Alerte sonore	Led violet
Alerte sonore musicale	Led bleu fixe
	Led rouge fixe

ALLUMER

	Appuyer 3 sec.
	Clignote
	Alerte sonore musicale
	État mode de fonctionnement
	État batterie

ÉTEINDRE

	Appuyer 3 sec. dans le même temps
	Clignote
	Alerte sonore musicale

COUPLAGES

DESCRIPTION DES COUPLAGES

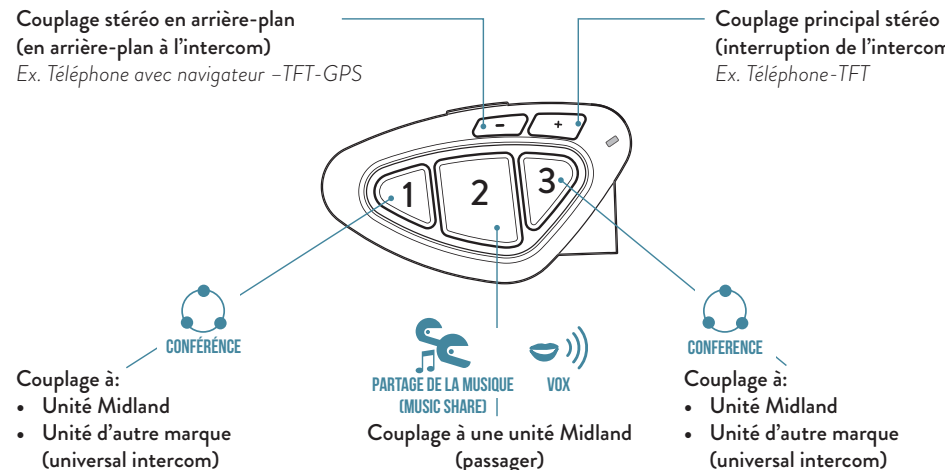

ENTRER DANS LE MODE DE CONFIGURATION

État: unité éteinte	
	Appuyer 7 sec.
	Allumé

SORTIR DU MODE DE CONFIGURATION/INTERROMPRE LE COUPLAGE

État: mode de configuration et pendant le couplage	
	Appuyer 2 fois

REMISE À ZÉRO DU COUPLAGE

État: mode de configuration	
	Appuyer 3 sec. dans le même temps
	S'allume
	Led rouge allumé

COUPLAGE AVEC UNE UNITÉ MIDLAND

État: led de deux unités en mode configuration	
	Appuyer 3 sec (effectuer la procédure dans le même temps sur les deux unités).
	Clignote
	Led bleu pendant 1 sec, couplage réussi
	Led rouge fixe, couplage terminé

Note: pour coupler des autres unités Midland, suivez la même procédure mais appuyez sur les touches 1 ou 3.

COUPLAGE AVEC UNE UNITÉ D'AUTRE MARQUE

État: mode de configuration	
1ère unité	
	Appuyer 7 sec. (effectuer la procédure dans le même temps sur les deux unités)
	Clignote rapidement (maintenir appuyé)
	Clignote lentement (relâcher la touche)
	Led fixe, couplage terminé
2ème unité	
	Suivez la procédure pour coupler un téléphone

Note: pour coupler un autre Universal Intercom, suivez la même procédure mais appuyez sur la touche 3.

COUPLAGE AVEC 4 UNITÉS EN CONFÉRENCE

État: mode de configuration	

Note: Le mode "Conférence" permet de mettre en communication des personnes simultanément. Pour utiliser la fonction de conférence, les appareils doivent être couplés dans une configuration "en chaîne": associez le bouton "Arrière" du premier BTX2 PRO S au bouton "Avant" du deuxième BTX2 PRO S et ainsi de suite. Pour plus d'informations, voir le paragraphe "Conférence" du manuel d'utilisation.

COUPLAGE AVEC UN TÉLÉPHONE/GPS

État: mode de configuration	
	Appuyer 3 sec
	Clignote
	Sélectionner l'unité dans votre téléphone
	Allumé 1 sec, couplage terminé

Note: l'unité couplée à Vol- est en arrière-plan à l'Intercom. Pour coupler l'unité et interrompre l'intercom, suivez la procédure mais appuyez sur Vol+.

Pour plus d'infos:
<https://support.midlandeuropa.com/>

Sélectionner un produit et:
Regarder le **video tutorial**
Télécharger le **software**
Lire le **manuel d'utilisation complet**

Télécharger **BTPRO SetAPP** depuis
Google Play ou **App Store**

Midland World



Prodotto o importato da/Produced or imported by: Midland Europe srl - Via R. Sevardi 7 - 42124 Reggio Emilia - Italy. Prima dell'uso leggere attentamente le istruzioni. Read the instructions carefully before installation and use. **Distributed by: MotoDirect Limited Company** - Euro House, The Nursery, 1 Wincobank Way, South Normanton, Derbyshire. DE55 2FX UK. Read the instructions carefully before installation and use. **Vertrieb durch: Alan Electronics GmbH** Daimlerstrasse 1g-D-63303 Dreieich Deutschland. Vor Benutzung Bedienungsanleitung beachten. **Importado por: Midland Iberia, SA** C/Cobalt, 48 - 08940 Cornellà de Llobregat, Barcelona - España. Antes de utilizar, lea atentamente el manual de uso. **Distribuíd par: Bihr S.A.S.** - www.bihr.eu. Avant l'utilisation, lire les instructions.



MODES DE FONCTIONNEMENT

- A. Mode Intercom:** pour parler à une autre unité.
- B. Mode téléphone:** pour les appels et pour gérer la musique.
- C. Mode radio FM*:** pour écouter, rechercher et mémoriser des stations de radio FM.

Note: les modes Intercom et Téléphone sont actifs seulement s'il y a des unités couplées.

CHANGER LE MODE DE FONCTIONNEMENT

État: unité allumée

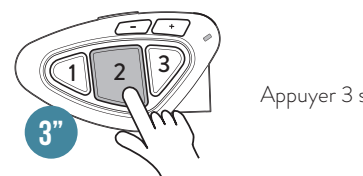

État mode de fonctionnement

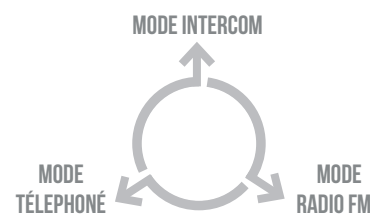

Raccourci - Rappeler l'état du mode de fonctionnement: appuyer 1 fois Vol-/Vol+ dans le même temps.

A. MODE INTERCOM

DESCRIPTION DES COUPLAGES

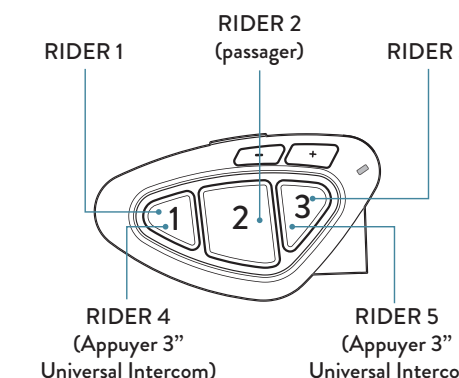

OUVRIR/FERMER L'INTERCOM MANUELLEMENT

État: mode Intercom

	Appuyer 1 fois
	Alerte sonore
	Clignote

Note: Si vous avez couplé une autre unité, appuyez sur les touches 1 et 3 pour ouvrir/fermer l'intercom.

OUVRIR/FERMER L'INTERCOM AVEC LA VOIX

État: en tous les modes

	Prononcer "Hello"
	Alerte sonore
	Clignote
	Silence pendant 40 sec. l'intercom se ferme
	Alerte sonore

ACTIVER/DÉSACTIVER LE VOX

État: en tous les modes

	Appuyer 7 sec.
	Alerte sonore

OUVRIR/FERMER L'UNIVERSAL INTERCOM

État: mode Intercom

	Appuyer 3 sec. pour ouvrir Universal Intercom
	Clignote
	Alerte sonore
	Appuyer 1 fois Pour fermer Universal Intercom

Note: Pour ouvrir/fermer l'audio d'une unité d'autre marque, utilisez la touche de rappel (pour quelque modèle, il faut envoyer le rappel deux fois).
Note: s'il y a une autre unité Universal Intercom, suivez la même procédure mais appuyer sur la touche 3.

Raccourci - Pour ouvrir l'intercom pendant l'écoute et le partage de la musique en mode téléphone : appuyer 2 fois sur bouton 2.

ACTIVER/DÉSACTIVER LE CONFÉRENCE

État: en tous les modes

	Appuyer 3 sec. dans le même temps pour activer/désactiver le Conférence
	Alerte sonore
	État Conférence

OUVRIR/FERMER LE CONFÉRENCE

État: Conférence

	Appuyer 1 fois pour ouvrir/fermer le conférence à l'unité couplée au bouton 1.
	Appuyer 1 fois pour ouvrir le Conférence à toutes les unités couplées
	Appuyer 1 fois pour ouvrir/fermer le Conférence à l'unité couplée au bouton 3.

Note: L'unité couplée à Vol+ est momentanément déconnectée, tandis que celle couplée à Vol- est toujours active.

B. MODE TÉLÉPHONE

DESCRIPTION DES TOUCHES

Téléphone couplé à Vol+

- Passer un appel
- Répondre
- Terminer un appel
- Rejeter un appel
- Chanson suivante

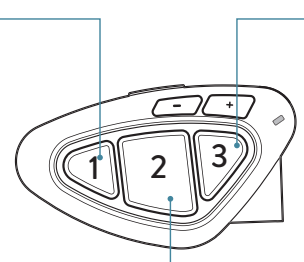

Téléphone couplé à Vol-

- Passer un appel
- Répondre
- Terminer un appel
- Rejeter un appel
- Chanson précédente

Play/pause

PASSER UN APPEL

État: mode téléphone

	Appuyer 1 fois
	Réponse assistant vocale (assistant Google, Siri)
	Donner instructions à votre assistant
	Commencer l'appel

Note: si vous avez un téléphone couplé au bouton Vol+, utilisez la touche 1.

RÉPONDRE/TERMINER UN APPEL

	Appuyer 1 fois
--	----------------

REJETER UN APPEL

	Appuyer 3 sec.
--	----------------

MUSIQUE

État: mode téléphone

	Sélectionner APP pour la musique
	Appuyer 1 fois Play/Pause
	Appuyer 1 fois Chanson suivante
	Appuyer 1 fois Chanson précédente
	Appuyer 3 sec. Active/désactive le partage de la musique avec le passager (Music share)

Raccourci - Play/Pause de la musique en mode Intercom/Radio FM: appuyer 2 fois sur la touche 2.

CONTRÔLE DE LA MUSIQUE VOL+/VOL-

État: en tous les modes

	Appuyer 3 sec.
	Contrôle Volt+/Vol-

Note: si vous avez connecté deux appareils multimédias, pour gérer la musique de l'appareil couplé à Vol-, vous devez configurer le contrôle de la musique sur Vol-. Pour gérer la musique de l'appareil couplé à Vol+, il faudra configurer le contrôle de la musique sur Vol+.

ACTIVER PUBLIC/PRIVÉ

État: en tous les modes

	Appuyer 3 sec.
	Privé Public

Avec l'activation du mode Public toutes les informations provenant de l'unité couplée à Vol- sont partagés. Les appels sont toujours privés.

C. MODE RADIO FM*

DESCRIPTION DES TOUCHES

Station suivante

Mémoire suivante

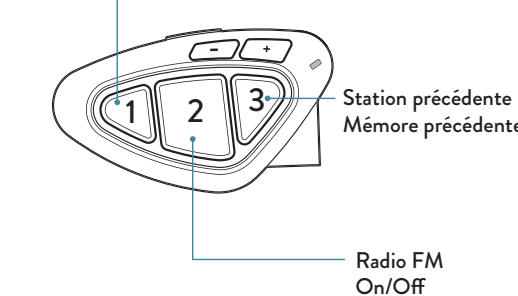

RADIO FM

État: mode Radio FM

	Appuyer 1 fois On/Off
	Station suivante
	Mémoire suivante
	Station précédente
	Mémoire précédente

*

Uniquement pour les versions équipées de la radio FM.