

▶ BEE431011M

- EN **User Manual**  
Oven
- DE **Benutzerinformation**  
Backofen
- FR **Notice d'utilisation**  
Four
- IT **Istruzioni per l'uso**  
Forno
- ES **Manual de instrucciones**  
Horno

# USER MANUAL



**AEG**

## FOR PERFECT RESULTS

Thank you for choosing this AEG product. We have created it to give you impeccable performance for many years, with innovative technologies that help make life simpler – features you might not find on ordinary appliances. Please spend a few minutes reading to get the very best from it.

Visit our website to:



Get usage advice, brochures, trouble shooter, service and repair information:  
[www.aeg.com/support](http://www.aeg.com/support)



Register your product for better service:  
[www.registeraeg.com](http://www.registeraeg.com)



Buy Accessories, Consumables and Original spare parts for your appliance:  
[www.aeg.com/shop](http://www.aeg.com/shop)

## CUSTOMER CARE AND SERVICE

Always use original spare parts.

When contacting our Authorised Service Centre, ensure that you have the following data available: Model, PNC, Serial Number.

The information can be found on the rating plate.

 Warning / Caution-Safety information

 General information and tips

 Environmental information

Subject to change without notice.

## CONTENTS

1. SAFETY INFORMATION.....	2
2. SAFETY INSTRUCTIONS.....	4
3. INSTALLATION.....	6
4. PRODUCT DESCRIPTION.....	8
5. CONTROL PANEL.....	8
6. BEFORE FIRST USE.....	9
7. DAILY USE.....	9
8. CLOCK FUNCTIONS.....	10
9. USING THE ACCESSORIES.....	12
10. ADDITIONAL FUNCTIONS.....	13
11. HINTS AND TIPS.....	13
12. CARE AND CLEANING.....	21
13. TROUBLESHOOTING.....	24
14. ENERGY EFFICIENCY.....	25

## 1. SAFETY INFORMATION

Before the installation and use of the appliance, carefully read the supplied instructions. The manufacturer is not responsible

for any injuries or damage that are the result of incorrect installation or usage. Always keep the instructions in a safe and accessible location for future reference.

### **1.1 Children and vulnerable people safety**

- This appliance can be used by children aged from 8 years and above and persons with reduced physical, sensory or mental capabilities or lack of experience and knowledge if they have been given supervision or instruction concerning the use of the appliance in a safe way and understand the hazards involved. Children of less than 8 years of age and persons with very extensive and complex disabilities shall be kept away from the appliance unless continuously supervised.
- Do not let children play with the appliance.
- Keep all packaging away from children and dispose of it appropriately.
- **WARNING:** Keep children and pets away from the appliance when it operates or when it cools down. Accessible parts become hot during use.
- If the appliance has a child safety device, it should be activated.
- Children shall not carry out cleaning and user maintenance of the appliance without supervision.

### **1.2 General Safety**

- Only a qualified person must install this appliance and replace the cable.
- **WARNING:** The appliance and its accessible parts become hot during use. Care should be taken to avoid touching heating elements.
- Always use oven gloves to remove or put in accessories or ovenware.
- Before carrying out any maintenance, disconnect the appliance from the power supply.
- **WARNING:** Ensure that the appliance is switched off before replacing the lamp to avoid the possibility of electric shock.

- Do not use the appliance before installing it in the built-in structure.
- Do not use a steam cleaner to clean the appliance.
- Do not use harsh abrasive cleaners or sharp metal scrapers to clean the glass door since they can scratch the surface, which may result in shattering of the glass.
- If the mains power supply cable is damaged, it must be replaced by the manufacturer, its Authorised Service Centre or similarly qualified persons to avoid an electrical hazard.
- To remove the shelf supports first pull the front of the shelf support and then the rear end away from the side walls. Install the shelf supports in the opposite sequence.

## 2. SAFETY INSTRUCTIONS

### 2.1 Installation



#### WARNING!

Only a qualified person must install this appliance.

- Remove all the packaging.
- Do not install or use a damaged appliance.
- Follow the installation instructions supplied with the appliance.
- Always take care when moving the appliance as it is heavy. Always use safety gloves and enclosed footwear.
- Do not pull the appliance by the handle.
- Install the appliance in a safe and suitable place that meets installation requirements.
- Keep the minimum distance from other appliances and units.
- Before mounting the appliance, check if the oven door opens without restraint.
- The appliance is equipped with an electric cooling system. It must be operated with the electric power supply.

Cabinet minimum height (Cabinet under the worktop minimum height)	590 (600) mm
---	--------------

Cabinet width	560 mm
---------------	--------

Cabinet depth	550 (550) mm
---------------	--------------

Height of the front of the appliance	594 mm
---	--------

Height of the back of the appliance	576 mm
Width of the front of the ap- pliance	595 mm
Width of the back of the appliance	559 mm
Depth of the appliance	569 mm
Built in depth of the appli- ance	548 mm
Depth with open door	1022 mm
Ventilation opening mini- mum size. Opening placed on the bottom rear side	560x20 mm
Mains supply cable length. Cable is placed in the right corner of the back side	1500 mm
Mounting screws	4x25 mm

### 2.2 Electrical connection



#### WARNING!

Risk of fire and electric shock.

- All electrical connections should be made by a qualified electrician.
- The appliance must be earthed.
- Make sure that the parameters on the rating plate are compatible with the electrical ratings of the mains power supply.

- Always use a correctly installed shockproof socket.
- Do not use multi-plug adapters and extension cables.
- Make sure not to cause damage to the mains plug and to the mains cable. Should the mains cable need to be replaced, this must be carried out by our Authorised Service Centre.
- Do not let mains cables touch or come near the appliance door or the niche below the appliance, especially when it operates or the door is hot.
- The shock protection of live and insulated parts must be fastened in such a way that it cannot be removed without tools.
- Connect the mains plug to the mains socket only at the end of the installation. Make sure that there is access to the mains plug after the installation.
- If the mains socket is loose, do not connect the mains plug.
- Do not pull the mains cable to disconnect the appliance. Always pull the mains plug.
- Use only correct isolation devices: line protecting cut-outs, fuses (screw type fuses removed from the holder), earth leakage trips and contactors.
- The electrical installation must have an isolation device which lets you disconnect the appliance from the mains at all poles. The isolation device must have a contact opening width of minimum 3 mm.
- This appliance is supplied with a main plug and a main cable.

**Cable types applicable for installation or replacement for Europe:**

H07 RN-F, H05 RN-F, H05 RRF, H05 VV-F, H05 V2V2-F (T90), H05 BB-F

For the section of the cable refer to the total power on the rating plate. You can also refer to the table:

Total power (W)	Section of the cable (mm <sup>2</sup> )
maximum 1380	3 x 0.75
maximum 2300	3 x 1
maximum 3680	3 x 1.5

The earth cord (green / yellow cable) must be 2 cm longer than phase and neutral cables (blue and brown cables).

### 2.3 Use



**WARNING!**

Risk of injury, burns and electric shock or explosion.

- This appliance is for household use only.
- Do not change the specification of this appliance.
- Make sure that the ventilation openings are not blocked.
- Do not let the appliance stay unattended during operation.
- Deactivate the appliance after each use.
- Be careful when you open the appliance door while the appliance is in operation. Hot air can release.
- Do not operate the appliance with wet hands or when it has contact with water.
- Do not apply pressure on the open door.
- Do not use the appliance as a work surface or as a storage surface.
- Open the appliance door carefully. The use of ingredients with alcohol can cause a mixture of alcohol and air.
- Do not let sparks or open flames to come in contact with the appliance when you open the door.
- Do not put flammable products or items that are wet with flammable products in, near or on the appliance.



**WARNING!**

Risk of damage to the appliance.

- To prevent damage or discoloration to the enamel:
  - do not put ovenware or other objects in the appliance directly on the bottom.
  - do not put aluminium foil directly on the bottom of cavity of the appliance.
  - do not put water directly into the hot appliance.
  - do not keep moist dishes and food in the appliance after you finish the cooking.
  - be careful when you remove or install the accessories.
- Discoloration of the enamel or stainless steel has no effect on the performance of the appliance.

- Use a deep pan for moist cakes. Fruit juices cause stains that can be permanent.
- This appliance is for cooking purposes only. It must not be used for other purposes, for example room heating.
- Always cook with the oven door closed.
- If the appliance is installed behind a furniture panel (e.g. a door) make sure the door is never closed when the appliance operates. Heat and moisture can build up behind a closed furniture panel and cause subsequent damage to the appliance, the housing unit or the floor. Do not close the furniture panel until the appliance has cooled down completely after use.

## 2.4 Care and cleaning



### WARNING!

Risk of injury, fire, or damage to the appliance.

- Before maintenance, deactivate the appliance and disconnect the mains plug from the mains socket.
- Make sure the appliance is cold. There is the risk that the glass panels can break.
- Replace immediately the door glass panels when they are damaged. Contact the Authorised Service Centre.
- Be careful when you remove the door from the appliance. The door is heavy!
- Clean regularly the appliance to prevent the deterioration of the surface material.
- Clean the appliance with a moist soft cloth. Use only neutral detergents. Do not use abrasive products, abrasive cleaning pads, solvents or metal objects.
- If you use an oven spray, follow the safety instructions on its packaging.

## 2.5 Internal lighting



### WARNING!

Risk of electric shock.

- Concerning the lamp(s) inside this product and spare part lamps sold separately: These lamps are intended to withstand extreme physical conditions in household appliances, such as temperature, vibration, humidity, or are intended to signal information about the operational status of the appliance. They are not intended to be used in other applications and are not suitable for household room illumination.
- Use only lamps with the same specifications.

## 2.6 Service

- To repair the appliance contact the Authorised Service Centre.
- Use original spare parts only.

## 2.7 Disposal



### WARNING!

Risk of injury or suffocation.

- Disconnect the appliance from the mains supply.
- Cut off the mains electrical cable close to the appliance and dispose of it.
- Remove the door catch to prevent children or pets from becoming trapped in the appliance.

# 3. INSTALLATION



### WARNING!

Refer to Safety chapters.

## 3.1 Building in



[www.youtube.com/electrolux](http://www.youtube.com/electrolux)  
[www.youtube.com/aeg](http://www.youtube.com/aeg)

How to install your AEG/Electrolux  
Oven - Column installation



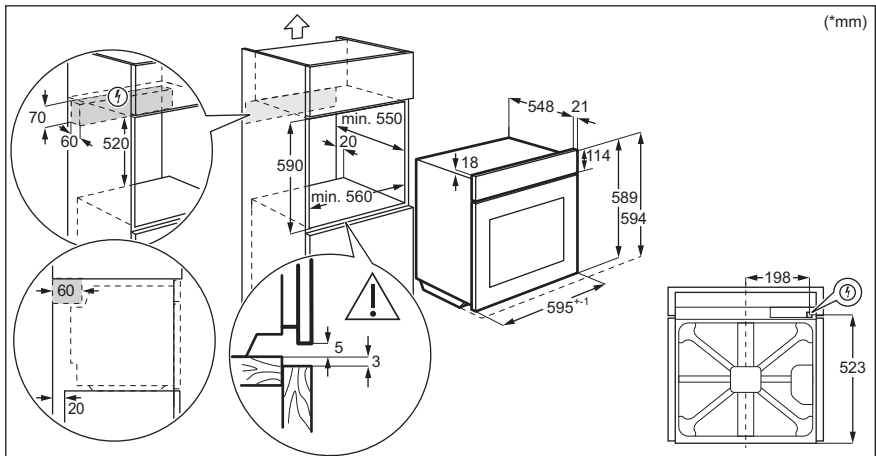
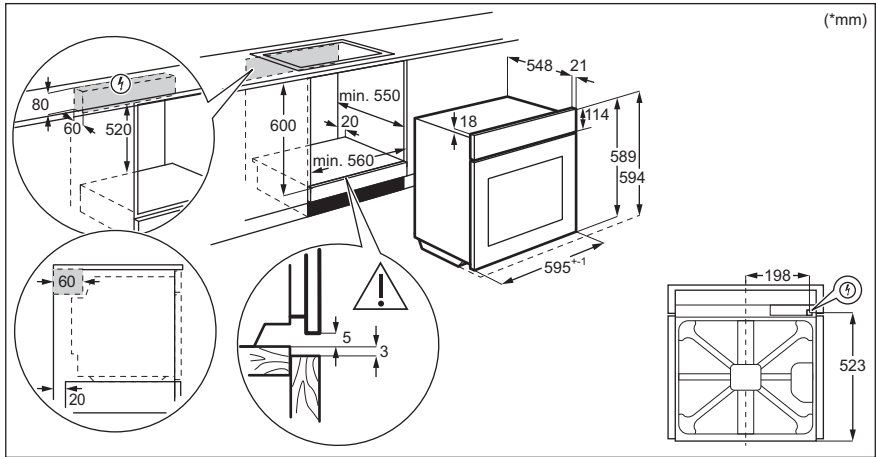

### 3.2 Securing the oven to the cabinet

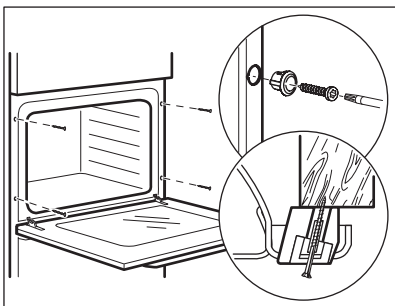

## 4. PRODUCT DESCRIPTION

### 4.1 General overview

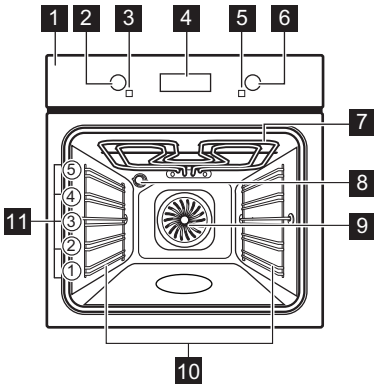

- 1 Control panel
- 2 Knob for the heating functions
- 3 Power lamp / symbol
- 4 Display
- 5 Temperature indicator / symbol
- 6 Control knob (for the temperature)
- 7 Heating element
- 8 Lamp
- 9 Fan
- 10 Shelf support, removable
- 11 Shelf positions

### 4.2 Accessories

- **Wire shelf**  
For cookware, cake tins, roasts.
- **Baking tray**

- For cakes and biscuits.
- **Grill- / Roasting pan**  
To bake and roast or as pan to collect fat.

## 5. CONTROL PANEL

### 5.1 Retractable knobs

To use the appliance press the knob. The knob comes out.

### 5.2 Sensor fields / Buttons

—	To set the time.
⌚	To set a clock function.
+	To set the time.



## 5.3 Display

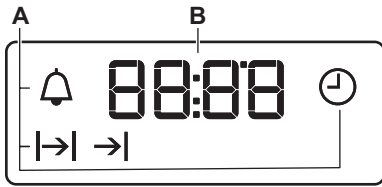

- A. Clock functions
- B. Timer

## 6. BEFORE FIRST USE



**WARNING!**  
Refer to Safety chapters.

### 6.1 Before first use

The oven can emit an odour and smoke during preheating. Make sure that the room is ventilated.



Step 1

#### Set the clock

1. - press to set the time. After approximately 5 sec., the flashing stops and the display shows the time.



Step 2

#### Clean the oven

1. Remove all accessories and removable shelf supports from the oven.
2. Clean the oven and the accessories with a soft cloth, warm water and a mild detergent.



Step 3

#### Preheat the empty oven

1. Set the maximum temperature for the function: .  
Time: 1 h.
2. Set the maximum temperature for the function: .  
Time: 15 min.
3. Set the maximum temperature for the function: .  
Time: 15 min.

Turn off the oven and wait until it is cold. Place the accessories and the removable shelf supports in the oven.

## 7. DAILY USE



**WARNING!**  
Refer to Safety chapters.







### 7.1 How to set: Heating function





- Step 1** Turn the knob for the heating functions to select a heating function.

**Step 2** Turn the control knob to select the temperature.

**Step 3** When the cooking ends, turn the knobs to the off position to turn off the oven.

## 7.2 Heating functions

Heating function	Application
 Off position	The oven is off.
 Light	To turn on the lamp.
 True Fan Cooking	To bake on up to three shelf positions at the same time and to dry food. Set the temperature 20 - 40 °C lower than for Conventional Cooking.
 Moist Fan Baking	This function is designed to save energy during cooking. When you use this function, the temperature in the cavity may differ from the set temperature. The heating power may be reduced. For more information refer to "Daily Use" chapter, Notes on: Moist Fan Baking.
 Bottom Heat	To bake cakes with crispy bottom and to preserve food.
 Grill	To grill thin pieces of food and to toast bread.

Heating function	Application
 Fast Grilling	To grill thin pieces of food in large quantities and to toast bread.
 Turbo Grilling	To roast large meat joints or poultry with bones on one shelf position. To make gratins and to brown.
 Pizza Function	To bake pizza. To make intensive browning and a crispy bottom.
 Conventional Cooking	To bake and roast food on one shelf position.

### 7.3 Notes on: Moist Fan Baking



This function was used to comply with the energy efficiency class and ecodesign requirements according to EU 65/2014 and EU 66/2014. Tests according to EN 60350-1.



The oven door should be closed during cooking so that the function is not interrupted and the oven operates with the highest energy efficiency possible.

For the cooking instructions refer to "Hints and tips" chapter, Moist Fan Baking. For general energy saving recommendations refer to "Energy Efficiency" chapter, Energy Saving.

## 8. CLOCK FUNCTIONS

### 8.1 Clock functions



Clock function	Application
 Time of Day	To set, change or check the time of day.
 Duration	To set how long the oven works.
 End Time	To set when the oven turns off.

Clock function	Application
 Time Delay	To combine functions: Duration and End Time.
 Minute Minder	To set a countdown. This function has no effect on the operation of the oven. You can set this function at any time, also when the oven is off.



## 8.2 How to set: Clock functions



### How to set: Time of Day

 - flashes when you connect the oven to the electrical supply, when there was a power cut or when the timer is not set.

 ,  - press to set the time.  
 After approximately 5 sec., the flashing stops and the display shows the time.

### How to change: Time of Day





**Step 1**  - press repeatedly to change the time of day.  - starts to flash.

**Step 2**  ,  - press to set the time.  
 After approximately 5 sec., the flashing stops and the display shows the time.

### How to set: Duration

**Step 1** Set an oven function and the temperature.

**Step 2**  - press repeatedly.  - starts to flash.

**Step 3**  ,  - press to set the duration.  
 The display shows:   
 - flashes when the set time ends. The signal sounds and the oven turns off.





**Step 4** Press any button to stop the signal.

**Step 5** Turn the knobs to the off position.

### How to set: End Time

**Step 1** Set an oven function and the temperature.









**Step 2**  - press repeatedly.  - starts to flash.

**Step 3**  ,  - press to set the time.  
 The display shows:   
 - flashes when the set time ends. The signal sounds and the oven turns off.





**Step 4** Press any button to stop the signal.

**Step 5** Turn the knobs to the off position.



### How to set: Time Delay

- Step 1** Set an oven function and the temperature.
- Step 2**  - press repeatedly.  - starts to flash.
- Step 3** ,  - press to set the time for: Duration.
- Step 4** Press: .
- Step 5** ,  - press to set the time for: End Time.
- Step 6** Press: .  
At the set time the signal sounds and the oven turns off.
- Step 7** Press any button to stop the signal.
- Step 8** Turn the knobs to the off position.

### How to set: Minute Minder

- Step 1**  - press repeatedly.  - starts to flash.
- Step 2** ,  - press to set the time.  
The function starts automatically after 5 sec.  
When the set time ends, the signal sounds.
- Step 3** Press any button to stop the signal.
- Step 4** Turn the knobs to the off position.

### How to cancel: Clock functions

- Step 1**  - press repeatedly until the clock function symbol starts to flash.
- Step 2** Press and hold: .  
The clock function turns off after few seconds.

## 9. USING THE ACCESSORIES



### WARNING!

Refer to Safety chapters.

### 9.1 Inserting accessories

A small indentation at the top increases safety. The indentations are also anti-tip

devices. The high rim around the shelf prevents cookware from slipping of the shelf.

**Wire shelf:**

Push the shelf between the guide bars of the shelf support and make sure that the feet point down.

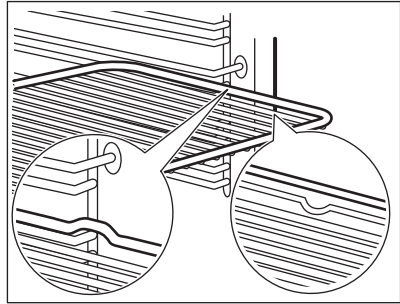

**Baking tray / Deep pan:**

Push the tray between the guide bars of the shelf support.

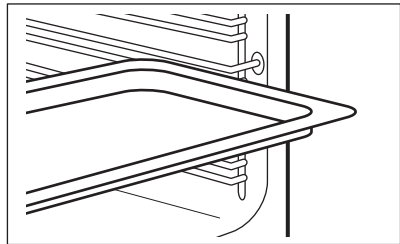

**Wire shelf, Baking tray / Deep pan:**

Push the tray between the guide bars of the shelf support and the wire shelf on the guide bars above.

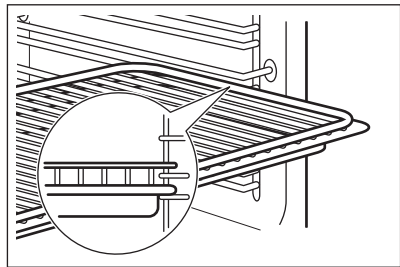

## 10. ADDITIONAL FUNCTIONS

### 10.1 Cooling fan

When the oven operates, the cooling fan turns on automatically to keep the surfaces of the oven cool. If you turn off the oven, the cooling fan can continue to operate until the oven cools down.

### 10.2 Safety thermostat

Incorrect operation of the oven or defective components can cause dangerous overheating. To prevent this, the oven has a safety thermostat which interrupts the power supply. The oven turns on again automatically when the temperature drops.

## 11. HINTS AND TIPS



Refer to Safety chapters.

### 11.1 Cooking recommendations

The oven has five shelf positions.

Count the shelf positions from the bottom of the oven floor.

Your oven may bake or roast differently to the oven you had before. The below tables provide you with the standard settings for temperature, cooking time and shelf position.

If you cannot find the settings for a special recipe, look for the similar one.

The oven has a special system which circulates the air and constantly recycles the steam. With this system you can cook in a steamy environment and keep the food soft inside and crusty outside. It decreases the cooking time and energy consumption.

### Baking cakes

Do not open the oven door before 3/4 of the set cooking time is up.

If you use two baking trays at the same time, keep one empty level between them.

### Cooking meat and fish

Use a deep pan for very fatty food to prevent the oven from stains that can be permanent.

Leave the meat for approximately 15 minutes before carving so that the juice does not seep out.







To prevent too much smoke in the oven during roasting, add some water into the deep pan. To prevent the smoke condensation, add water each time after it dries up.







### Cooking times

Cooking times depend on the type of food, its consistency, and volume.







Initially, monitor the performance when you cook. Find the best settings (heat setting, cooking time, etc.) for your cookware, recipes and quantities when you use this appliance.

## 11.2 Baking and roasting

 <b>CAKES</b>	Conventional Cooking		True Fan Cooking		 (min)	
	 (°C)		 (°C)			
Whisked recipes	170	2	160	3 (2 and 4)	45 - 60	Cake mould
Shortbread dough	170	2	160	3 (2 and 4)	20 - 30	Cake mould
Buttermilk cheese-cake	170	1	165	2	60 - 80	Cake mould, Ø 26 cm
Strudel	175	3	150	2	60 - 80	Baking tray
Jam tart	170	2	165	2	30 - 40	Cake mould, Ø 26 cm
Christmas cake, preheat the empty oven	160	2	150	2	90 - 120	Cake mould, Ø 20 cm
Plum cake, pre-heat the empty oven	175	1	160	2	50 - 60	Bread tin
Muffins	170	3	140 - 150	3	20 - 30	Baking tray
Muffins, two levels	-	-	140 - 150	2 and 4	25 - 35	Baking tray
Muffins, three levels	-	-	140 - 150	1, 3 and 5	30 - 45	Baking tray
Biscuits	140	3	140 - 150	3	30 - 35	Baking tray







 <b>CAKES</b>	Conventional Cooking		True Fan Cooking		 (min)	
	 (°C)		 (°C)			
Biscuits, two levels	-	-	140 - 150	2 and 4	35 - 40	Baking tray
Biscuits, three levels	-	-	140 - 150	1, 3 and 5	35 - 45	Baking tray
Meringues	120	3	120	3	80 - 100	Baking tray
Meringues, two levels, preheat the empty oven	-	-	120	2 and 4	80 - 100	Baking tray
Buns, preheat the empty oven	190	3	190	3	12 - 20	Baking tray
Eclairs	190	3	170	3	25 - 35	Baking tray
Eclairs, two levels	-	-	170	2 and 4	35 - 45	Baking tray
Plate tarts	180	2	170	2	45 - 70	Cake mould, Ø 20 cm
Rich fruit cake	160	1	150	2	110 - 120	Cake mould, Ø 24 cm

Preheat the empty oven.

 <b>BREAD AND PIZZA</b>	Conventional Cooking		True Fan Cooking		 (min)	
	 (°C)		 (°C)			
White bread, 1 - 2 pieces, 0.5 kg each	190	1	190	1	60 - 70	-
Rye bread, preheating is not needed	190	1	180	1	30 - 45	Bread tin
Bread rolls, 6 - 8 rolls	190	2	180	2 (2 and 4)	25 - 40	Baking tray
Pizza	230 - 250	1	230 - 250	1	10 - 20	Enamelled tray
Scones	200	3	190	3	10 - 20	Baking tray







Preheat the empty oven.







Use the cake mould.

 <b>FLANS</b>	Conventional Cooking		True Fan Cooking		 (min)
	 (°C)		 (°C)		
Pasta flan, preheating is not needed	200	2	180	2	40 - 50
Vegetable flan, preheating is not needed	200	2	175	2	45 - 60
Quiches	180	1	180	1	50 - 60
Lasagne	180 - 190	2	180 - 190	2	25 - 40
Cannelloni	180 - 190	2	180 - 190	2	25 - 40







Use the second shelf position.

Use the wire shelf.





 <b>MEAT</b>	Conventional Cooking		True Fan Cooking		 (min)
	 (°C)		 (°C)		
Beef	200		190		50 - 70
Pork	180		180		90 - 120
Veal	190		175		90 - 120
English roast beef, rare	210		200		50 - 60
English roast beef, medium	210		200		60 - 70
English roast beef, well done	210		200		70 - 75

 <b>MEAT</b>	Conventional Cooking		True Fan Cooking		 (min)
	 (°C)		 (°C)		
Pork shoulder, with rind	180	2	170	2	120 - 150
Pork shin, 2 pieces	180	2	160	2	100 - 120
Leg of lamb	190	2	175	2	110 - 130
Whole chicken	220	2	200	2	70 - 85
Whole turkey	180	2	160	2	210 - 240
Whole duck	175	2	220	2	120 - 150
Whole goose	175	2	160	1	150 - 200
Rabbit, cut in pieces	190	2	175	2	60 - 80



 MEAT	Conventional Cooking		True Fan Cooking		 (min)
	 (°C)		 (°C)		
Hare, cut in pieces	190	2	175	2	150 - 200
Whole pheasant	190	2	175	2	90 - 120

Use the second shelf position.





 FISH	Conventional Cooking		True Fan Cooking	 (min)
	 (°C)		 (°C)	
Trout / Sea bream, 3 - 4 fish	190		175	40 - 55
Tuna / Salmon, 4 - 6 fillets	190		175	35 - 60

### 11.3 Grill

Preheat the empty oven.

Use the fourth shelf position.

Grill with the maximum temperature setting.



 GRILL	 (kg)	 (min)	 (min)
		1st side	2nd side
Fillet steaks, 4 pieces	0.8	12 - 15	12 - 14
Beef steak, 4 pieces	0.6	10 - 12	6 - 8
Sausages, 8	-	12 - 15	10 - 12
Pork chops, 4 pieces	0.6	12 - 16	12 - 14
Chicken, half, 2	1	30 - 35	25 - 30
Kebabs, 4	-	10 - 15	10 - 12
Chicken breast, 4 pieces	0.4	12 - 15	12 - 14
Burgers, 6	0.6	20 - 30	-
Fish fillet, 4 pieces	0.4	12 - 14	10 - 12
Toasted sandwiches, 4 - 6	-	5 - 7	-
Toast, 4 - 6	-	2 - 4	2 - 3



### 11.4 Turbo Grilling



Preheat the empty oven.



Use the first or the second shelf position.



To calculate the roasting time multiple the time given in the table below by the centimetres of thickness of the fillet.



 <b>BEEF</b>	 (°C)	 (min)
Roast beef or fillet, rare	190 - 200	5 - 6
Roast beef or fillet, medium	180 - 190	6 - 8
Roast beef or fillet, well done	170 - 180	8 - 10



 <b>PORK</b>	 (°C)	 (min)
Shoulder / Neck / Ham joint, 1 - 1.5 kg	160 - 180	90 - 120
Chops / Spare rib, 1 - 1.5 kg	170 - 180	60 - 90
Meatloaf, 0.75 - 1 kg	160 - 170	50 - 60
Pork knuckle, pre-cooked, 0.75 - 1 kg	150 - 170	90 - 120

 <b>VEAL</b>	 (°C)	 (min)
Roast veal, 1 kg	160 - 180	90 - 120
Veal knuckle, 1.5 - 2 kg	160 - 180	120 - 150

 <b>LAMB</b>	 (°C)	 (min)
Lamb leg / Roast lamb, 1 - 1.5 kg	150 - 170	100 - 120
Lamb saddle, 1 - 1.5 kg	160 - 180	40 - 60

 <b>POULTRY</b>	 (°C)	 (min)
Poultry, portions, 0.2 - 0.25 kg each	200 - 220	30 - 50
Chicken, half, 0.4 - 0.5 kg each	190 - 210	35 - 50
Chicken, poulard, 1 - 1.5 kg	190 - 210	50 - 70
Duck, 1.5 - 2 kg	180 - 200	80 - 100

 <b>POULTRY</b>	 (°C)	 (min)
Goose, 3.5 - 5 kg	160 - 180	120 - 180
Turkey, 2.5 - 3.5 kg	160 - 180	120 - 150
Turkey, 4 - 6 kg	140 - 160	150 - 240

 <b>FISH (STEAMED)</b>	 (°C)	 (min)
Whole fish, 1 - 1.5 kg	210 - 220	40 - 60



## 11.5 Dehydrating - True Fan Cooking

Cover trays with grease proof paper or baking parchment.



For a better result, stop the oven halfway through the drying time, open the door and let it cool down for one night to complete the drying.

For 1 tray use the third shelf position.

For 2 trays use the first and fourth shelf position.

 <b>VEGETABLES</b>	 (°C)	 (h)
Beans	60 - 70	6 - 8
Peppers	60 - 70	5 - 6
Vegetables for soup	60 - 70	5 - 6
Mushrooms	50 - 60	6 - 8
Herbs	40 - 50	2 - 3

Set the temperature to 60 - 70 °C.

 <b>FRUIT</b>	 (h)
Plums	8 - 10
Apricots	8 - 10
Apple slices	6 - 8
Pears	6 - 9

## 11.6 Moist Fan Baking - recommended accessories

Use the dark and non-reflective tins and containers. They have better heat absorption than the light colour and reflective dishes.

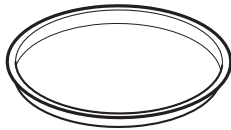

**Pizza pan**

Dark, non-reflective  
28 cm diameter

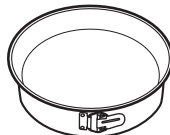

**Baking dish**

Dark, non-reflective  
26 cm diameter



**Ramekins**

Ceramic  
8 cm diameter, 5  
cm height

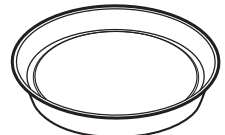











**Flan base tin**

Dark, non-reflective  
28 cm diameter

## 11.7 Moist Fan Baking







For the best results follow suggestions listed in the table below.







		 (°C)		 (min)
Sweet rolls, 12 pieces	baking tray or dripping pan	175	3	40 - 50
Rolls, 9 pieces	baking tray or dripping pan	180	2	35 - 45
Pizza, frozen, 0.35 kg	wire shelf	180	2	45 - 55
Swiss roll	baking tray or dripping pan	170	2	30 - 40
Brownie	baking tray or dripping pan	170	2	45 - 50
Soufflè, 6 pieces	ceramic ramekins on wire shelf	190	3	45 - 55
Sponge flan base	flan base tin on wire shelf	180	2	35 - 45
Victoria sandwich	baking dish on wire shelf	170	2	35 - 50
Poached fish, 0.3 kg	baking tray or dripping pan	180	2	35 - 45
Whole fish, 0.2 kg	baking tray or dripping pan	180	3	25 - 35
Fish fillet, 0.3 kg	pizza pan on wire shelf	170	3	30 - 40
Poached meat, 0.25 kg	baking tray or dripping pan	180	3	35 - 45
Shashlik, 0.5 kg	baking tray or dripping pan	180	3	40 - 50
Cookies, 16 pieces	baking tray or dripping pan	150	2	30 - 45
Macaroons, 20 pieces	baking tray or dripping pan	180	2	45 - 55
Muffins, 12 pieces	baking tray or dripping pan	170	2	30 - 40
Savory pastry, 16 pieces	baking tray or dripping pan	170	2	35 - 45

		 (°C)		 (min)
Short crust biscuits, 20 pieces	baking tray or dripping pan	150	2	40 - 50
Tartlets, 8 pieces	baking tray or dripping pan	170	2	30 - 40
Vegetables, poached, 0.4 kg	baking tray or dripping pan	180	2	35 - 45
Vegetarian omelette	pizza pan on wire shelf	180	3	35 - 45
Mediterranean vegetables, 0.7 kg	baking tray or dripping pan	180	4	35 - 45

## 11.8 Information for test institutes

Tests according to IEC 60350-1.

				 (°C)	 (min)	
Small cakes, 20 per tray	Conventional Cooking	Baking tray	3	170	20 - 30	-
Small cakes, 20 per tray	True Fan Cooking	Baking tray	3	150 - 160	20 - 35	-
Small cakes, 20 per tray	True Fan Cooking	Baking tray	2 and 4	150 - 160	20 - 35	-
Apple pie, 2 tins Ø20 cm	Conventional Cooking	Wire shelf	2	180	70 - 90	-
Apple pie, 2 tins Ø20 cm	True Fan Cooking	Wire shelf	2	160	70 - 90	-
Sponge cake, cake mould Ø26 cm	Conventional Cooking	Wire shelf	2	170	40 - 50	Preheat the oven for 10 minutes.
Sponge cake, cake mould Ø26 cm	True Fan Cooking	Wire shelf	2	160	40 - 50	Preheat the oven for 10 minutes.
Sponge cake, cake mould Ø26 cm	True Fan Cooking	Wire shelf	2 and 4	160	40 - 60	Preheat the oven for 10 minutes.
Short bread	True Fan Cooking	Baking tray	3	140 - 150	20 - 40	-

				 (°C)	 (min)	
Short bread	True Fan Cooking	Baking tray	2 and 4	140 - 150	25 - 45	-
Short bread	Conventional Cooking	Baking tray	3	140 - 150	25 - 45	-
Toast, 4 - 6 pieces	Grill	Wire shelf	4	max.	2 - 3 minutes first side; 2 - 3 minutes second side	Preheat the oven for 3 minutes.
Beef burger, 6 pieces, 0.6 kg	Grill	Wire shelf and dripping pan	4	max.	20 - 30	Put the wire shelf on the fourth level and the dripping pan on the third level of the oven. Turn the food halfway through the cooking time. Preheat the oven for 3 minutes.

## 12. CARE AND CLEANING



### WARNING!

Refer to Safety chapters.

### 12.1 Notes on cleaning



#### Cleaning Agents

Clean the front of the oven with a soft cloth with warm water and a mild detergent. Clean and check the door gasket around the frame of the cavity.

Use a cleaning solution to clean metal surfaces.

Clean stains with a mild detergent.



#### Everyday Use

Clean the cavity after each use. Fat accumulation or other residue may cause fire.

Moisture can condense in the oven or on the door glass panels. To decrease the condensation, let the oven work for 10 minutes before cooking. Do not store the food in the oven for longer than 20 minutes. Dry the cavity with a soft cloth after each use.



#### Accessories

Clean all accessories after each use and let them dry. Use a soft cloth with warm water and a mild detergent. Do not clean the accessories in a dishwasher.

Do not clean the non-stick accessories using abrasive cleaner or sharp-edged objects.

### 12.2 How to remove: Shelf supports

Remove the shelf supports to clean the oven.

**Step 1** Turn off the oven and wait until it is cold.

**Step 2** Pull the front of the shelf support away from the side wall.

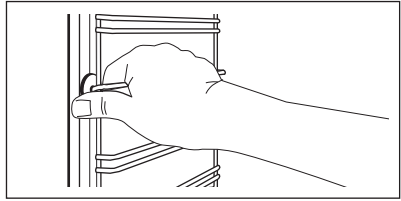

**Step 3** Pull the rear end of the shelf support away from the side wall and remove it.

**Step 4** Install the shelf supports in the opposite sequence.

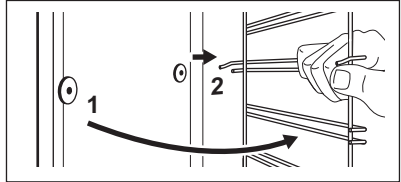

## 12.3 How to remove and install: Door

The oven door has three glass panels. You can remove the oven door and the internal glass panels to clean them. Read the whole "Removing and installing door" instruction before you remove the glass panels.



### CAUTION!

Do not use the oven without the glass panels.

**Step 1** Fully open the door and find the hinge to the right side of the door.

**Step 2** Use a screwdriver to lift and turn fully the right side hinge lever.

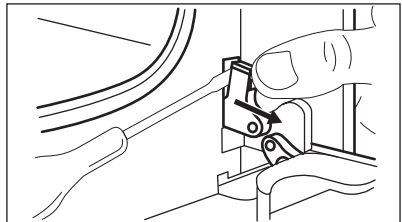

**Step 3** Find the hinge to the left side of the door.

**Step 4** Lift and turn the lever fully on the left hinge.

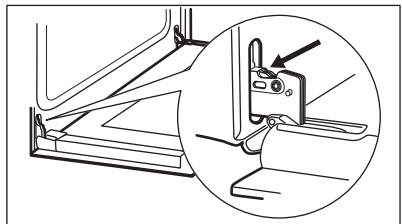

**Step 5** Close the oven door halfway to the first opening position. Then lift and pull forward and remove the door from its seat.

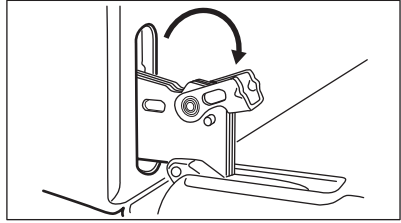

**Step 6** Put the door on a soft cloth on a stable surface.

**Step 7** Hold the door trim (B) on the top edge of the door at the two sides and push inwards to release the clip seal.

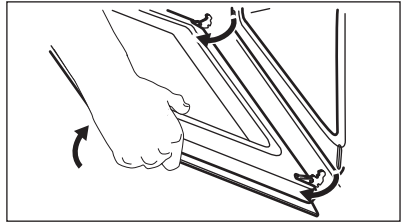

**Step 8** Pull the door trim to the front to remove it.

**Step 9** Hold the door glass panels by their top edge and carefully pull them out one by one. Start from the top panel. Make sure the glass slides out of the supports completely.

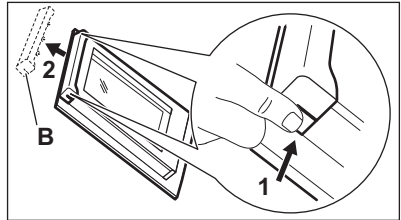

**Step 10** Clean the glass panels with water and soap. Dry the glass panels carefully. Do not clean the glass panels in the dishwasher.

**Step 11** After cleaning, install the glass panels and the oven door.

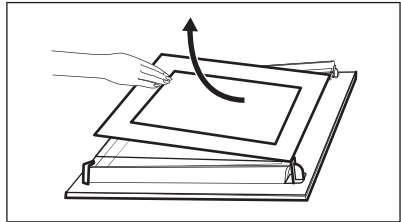

Make sure that you put the glass panels (A and B) back in the correct sequence. Check for the symbol / printing on the side of the glass panel, each of the glass panels looks different to make the disassembly and assembly easier.  
 When installed correctly the door trim clicks.  
 Make sure that you install the middle panel of glass in the seats correctly.

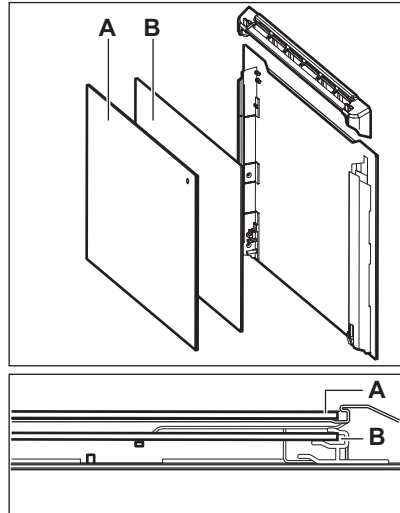

## 12.4 How to replace: Lamp



**WARNING!**  
 Risk of electric shock.  
 The lamp can be hot.

Always hold the halogen lamp with a cloth to prevent grease residue from burning on the lamp.

### Before you replace the lamp:

Step 1	Step 2	Step 3
Turn off the oven. Wait until the oven is cold.	Disconnect the oven from the mains.	Put a cloth on the bottom of the cavity.

## Back lamp

**Step 1** Turn the glass cover to remove it.

**Step 2** Clean the glass cover.

**Step 3** Replace the lamp with a suitable 300 °C heat-resistant lamp.

**Step 4** Install the glass cover.

## 13. TROUBLESHOOTING



**WARNING!**  
 Refer to Safety chapters.

### 13.1 What to do if...

In any cases not included in this table please contact with an Authorised Service Centre.



Problem	Check if...
The oven does not heat up.	The fuse is blown.
The door gasket is damaged.	Do not use the oven. Contact an Authorised Service Centre.
The display shows "12.00".	There was a power cut. Set the time of day.

Problem	Check if...
The lamp does not work.	The lamp is burnt out.

### 13.2 Service data

If you cannot find a solution to the problem yourself, contact your dealer or an Authorised Service Centre.

The necessary data for the service centre is on the rating plate. The rating plate is on the front frame of the oven cavity. Do not remove the rating plate from the oven cavity.

#### We recommend that you write the data here:

Model (MOD.)	.....
Product number (PNC)	.....
Serial number (S.N.)	.....

## 14. ENERGY EFFICIENCY

### 14.1 Product Information and Product Information Sheet\*

Supplier's name	AEG
Model identification	BEE431011M 949496317
Energy Efficiency Index	95.3
Energy efficiency class	A
Energy consumption with a standard load, conventional mode	0.93 kWh/cycle
Energy consumption with a standard load, fan-forced mode	0.81 kWh/cycle
Number of cavities	1
Heat source	Electricity
Volume	72 l
Type of oven	Built-In Oven
Mass	30.2 kg

\* For European Union according to EU Regulations 65/2014 and 66/2014.  
 For Republic of Belarus according to STB 2478-2017, Appendix G; STB 2477-2017, Annexes A and B.  
 For Ukraine according to 568/32020.

Energy efficiency class is not applicable for Russia.

EN 60350-1 - Household electric cooking appliances - Part 1: Ranges, ovens, steam ovens and grills - Methods for measuring performance.

## 14.2 Energy saving



The oven has features which help you save energy during everyday cooking.

Make sure that the oven door is closed when the oven operates. Do not open the oven door too often during cooking. Keep the door gasket clean and make sure it is well fixed in its position.

Use metal cookware to improve energy saving.

When possible, do not preheat the oven before cooking.

Keep breaks between baking as short as possible when you prepare a few dishes at one time.

### **Cooking with fan**

When possible, use the cooking functions with fan to save energy.

### **Residual heat**

When the cooking duration is longer than 30 min, reduce the oven temperature to minimum 3 - 10 min before the end of cooking. The residual heat inside the oven will continue to cook.

Use the residual heat to warm up other dishes.

### **Keep food warm**

Choose the lowest possible temperature setting to use residual heat and keep a meal warm.

### **Moist Fan Baking**

Function designed to save energy during cooking.

## 15. ENVIRONMENTAL CONCERNS

Recycle materials with the symbol . Put the packaging in relevant containers to recycle it. Help protect the environment and human health by recycling waste of electrical and electronic appliances. Do not dispose of

appliances marked with the symbol  with the household waste. Return the product to your local recycling facility or contact your municipal office.

## FÜR PERFEKTE ERGEBNISSE

Danke, dass Sie sich für dieses AEG Produkt entschieden haben. Wir haben es geschaffen, damit Sie viele Jahre von seiner ausgezeichneten Leistung und den innovativen Technologien, die Ihnen das Leben erleichtern, profitieren können. Es ist mit Funktionen ausgestattet, die in gewöhnlichen Geräten nicht vorhanden sind. Bitte nehmen Sie sich ein paar Minuten Zeit, um das Beste aus ihm herauszuholen.

**Besuchen Sie uns auf unserer Website, um:**



Anwendungshinweise, Prospekte, Informationen zu Fehlerbehebung, Service und Reparatur zu erhalten:

**[www.aeg.com/support](http://www.aeg.com/support)**



Registrieren Sie Ihr Produkt, um einen erstklassigen Service zu erhalten:

**[www.registreaeg.com](http://www.registreaeg.com)**



Um Zubehör, Verbrauchsmaterial und Original-Ersatzteile für Ihr Gerät zu kaufen:

**[www.aeg.com/shop](http://www.aeg.com/shop)**

## KUNDENDIENST UND SERVICE

Verwenden Sie immer Original-Ersatzteile.

Halten Sie folgende Angaben bereit, wenn Sie sich an einen autorisierten Kundendienst wenden: Modell, PNC, Seriennummer.

Die Daten finden Sie auf dem Typenschild.

 Warnungs-/Sicherheitshinweise

 Allgemeine Informationen und Empfehlungen

 Informationen zum Umweltschutz

Änderungen vorbehalten.

## INHALTSVERZEICHNIS

1. SICHERHEITSHINWEISE.....	28
2. SICHERHEITSANWEISUNGEN.....	29
3. MONTAGE.....	32
4. GERÄTEBESCHREIBUNG.....	34
5. BEDIENFELD.....	34
6. VOR DER ERSTEN INBETRIEBNAHME.....	35
7. TÄGLICHER GEBRAUCH.....	35
8. UHRFUNKTIONEN.....	37
9. VERWENDUNG DES ZUBEHÖRS.....	39
10. ZUSATZFUNKTIONEN.....	40
11. TIPPS UND HINWEISE.....	40
12. REINIGUNG UND PFLEGE.....	48
13. FEHLERSUCHE.....	51
14. ENERGIEEFFIZIENZ.....	51

## 1. ⚠️ SICHERHEITSHINWEISE

Lesen Sie vor der Montage und dem Gebrauch des Geräts zuerst die Bedienungsanleitung. Bei Verletzungen oder Schäden infolge nicht ordnungsgemäßer Montage oder Verwendung übernimmt der Hersteller keine Haftung. Bewahren Sie die Anleitung zum Nachschlagen an einem sicheren und zugänglichen Ort auf.

### 1.1 Sicherheit von Kindern und schutzbedürftigen Personen

- Das Gerät kann von Kindern ab 8 Jahren und Personen mit eingeschränkten physischen, sensorischen oder geistigen Fähigkeiten oder mit mangelnder Erfahrung und/oder mangelndem Wissen nur dann verwendet werden, wenn sie durch eine für ihre Sicherheit zuständige Person beaufsichtigt werden oder in die sichere Verwendung des Geräts eingewiesen wurden und die mit dem Gerät verbundenen Gefahren verstanden haben. Kinder unter 8 Jahren und Personen mit schweren Behinderungen oder Mehrfachbehinderung müssen vom Gerät ferngehalten werden, wenn sie nicht ständig beaufsichtigt werden.
- Kinder dürfen nicht mit dem Gerät spielen.
- Halten Sie sämtliches Verpackungsmaterial von Kindern fern und entsorgen Sie es ordnungsgemäß.
- **WARNUNG:** Halten Sie Kinder und Haustiere während des Betriebs oder der Abkühlphase vom Gerät fern. Die zugänglichen Geräteteile werden beim Betrieb sehr heiß.
- Falls Ihr Gerät mit einer Kindersicherung ausgestattet ist, empfehlen wir, diese einzuschalten.
- Kinder dürfen keine Reinigung und Wartung ohne Beaufsichtigung durchführen.

### 1.2 Allgemeine Sicherheit

- Die Montage des Geräts und der Austausch des Kabels muss von einer Fachkraft vorgenommen werden.

- **WARNUNG:** Das Gerät und die zugänglichen Geräteteile werden während des Betriebs heiß. Seien Sie vorsichtig und berühren Sie niemals die Heizelemente.
- Verwenden Sie zum Anfassen des Zubehörs und der Töpfe wärmeisolierende Handschuhe.
- Ziehen Sie bitte vor jeder Wartungsmaßnahme den Netzstecker aus der Steckdose.
- **WARNUNG:** Vergewissern Sie sich, dass das Gerät ausgeschaltet ist, bevor Sie die Lampe austauschen, um einen Stromschlag zu vermeiden.
- Verwenden Sie das Gerät nicht, bevor es in den Einbauschrank gesetzt wird.
- Reinigen Sie das Gerät nicht mit einem Dampfstrahlreiniger.
- Benutzen Sie keine scharfe Scheuermittel oder Metallschwämmchen zum Reinigen der Glasür; sie können die Glasfläche verkratzen und zum Zersplittern der Scheibe führen.
- Wenn das Netzkabel beschädigt ist, muss es vom Hersteller, seinem autorisierten Kundenservice oder einer gleichermaßen qualifizierten Person ausgetauscht werden, um Gefahren durch elektrischen Strom zu vermeiden.
- Ziehen Sie die Einhängegitter erst vorne und dann hinten von der Seitenwand weg und nehmen Sie sie heraus. Führen Sie zum Einsetzen der Einhängegitter die oben aufgeführten Schritte in umgekehrter Reihenfolge durch.

## 2. SICHERHEITSANWEISUNGEN

### 2.1 Montage



#### **WARNUNG!**

Die Montage des Geräts darf nur von einer qualifizierten Fachkraft durchgeführt werden.

- Entfernen Sie das gesamte Verpackungsmaterial.
- Montieren Sie ein beschädigtes Gerät nicht und benutzen Sie es nicht.
- Halten Sie sich an die mitgelieferte Montageanleitung.
- Seien Sie beim Umsetzen des Gerätes vorsichtig, da es sehr schwer ist. Tragen Sie stets Sicherheitshandschuhe und festes Schuhwerk.
- Ziehen Sie das Gerät nicht am Griff.
- Montieren Sie das Gerät an einem sicheren und geeigneten Ort, der den Montageanforderungen entspricht.
- Die Mindestabstände zu anderen Geräten und Küchenmöbeln sind einzuhalten.
- Überprüfen Sie vor der Montage des Gerätes, ob sich die Ofentür ohne Kraftanwendung öffnen lässt.

- Das Gerät ist mit einem elektrischen Kühlsystem ausgestattet. Es muss an die Stromversorgung angeschlossen werden.

Mindesthöhe des Einbaumöbels (Mindesthöhe des Schrankes unter der Arbeitsplatte)	590 (600) mm
Schrankbreite	560 mm
Schranktiefe	550 (550) mm
Höhe der Gerätevorderseite	594 mm
Höhe der Geräterückseite	576 mm
Breite der Gerätevorderseite	595 mm
Breite der Geräterückseite	559 mm
Gerätetiefe	569 mm
Geräteeinbautiefe	548 mm
Tiefe bei geöffneter Tür	1022 mm
Mindestgröße der Belüftungsöffnung. Öffnung auf der Rückseite unten	560x20 mm
Länge des Netzanschlusskabels. Das Kabel befindet sich in der rechten Ecke auf der Rückseite.	1500 mm
Befestigungsschrauben	4x25 mm

## 2.2 Elektroanschluss



### WARNUNG!

Brand- und Stromschlaggefahr.

- Alle elektrischen Anschlüsse sind von einem geprüften Elektriker vorzunehmen.
- Das Gerät muss geerdet sein.
- Stellen Sie sicher, dass die Daten auf dem Typenschild mit den elektrischen Nennwerten der Netzspannung übereinstimmen.
- Schließen Sie das Gerät nur an eine ordnungsgemäß installierte Schutzkontaktsteckdose an.
- Verwenden Sie keine Mehrfachsteckdosen oder Verlängerungskabel.
- Achten Sie darauf, Netzstecker und Netzkabel nicht zu beschädigen. Falls das Netzkabel des Geräts ersetzt werden muss, lassen Sie diese Arbeit durch

unseren autorisierten Kundendienst durchführen.

- Achten Sie darauf, dass das Netzkabel die Gerätetür oder die Nische unter dem Gerät nicht berührt oder in ihre Nähe gelangt, insbesondere wenn das Gerät eingeschaltet oder die Tür heiß ist.
- Alle Teile, die gegen direktes Berühren schützen, sowie die isolierten Teile müssen so befestigt werden, dass sie nicht ohne Werkzeug entfernt werden können.
- Stecken Sie den Netzstecker erst nach Abschluss der Montage in die Steckdose. Stellen Sie sicher, dass der Netzstecker nach der Montage noch zugänglich ist.
- Falls die Steckdose lose ist, schließen Sie den Netzstecker nicht an.
- Ziehen Sie nicht am Netzkabel, wenn Sie das Gerät von der Stromversorgung trennen möchten. Ziehen Sie stets am Netzstecker.
- Verwenden Sie nur geeignete Trenneinrichtungen: Überlastschalter, Sicherungen (Schraubsicherungen müssen aus dem Halter entfernt werden können), Fehlerstromschutzschalter und Schütze.
- Die elektrische Installation muss eine Trenneinrichtung aufweisen, mit der Sie das Gerät allpolig von der Stromversorgung trennen können. Die Trenneinrichtung muss mit einer Kontaktöffnungsweite von mindestens 3 mm ausgeführt sein.
- Das Gerät wird mit einem Netzstecker und Netzkabel geliefert.

### Einsetzbare Kabeltypen für Einbau oder Austausch in Europa:

H07 RN-F, H05 RN-F, H05 RRF, H05 VV-F, H05 V2V2-F (T90), H05 BB-F

Näheres zum Kabelquerschnitt siehe Gesamtleistung auf dem Typenschild. Weitere Informationen finden Sie in der Tabelle:

Gesamtleistung (W)	Kabelquerschnitt (mm <sup>2</sup> )
Maximal 1380	3 x 0.75
Maximal 2300	3 x 1

Gesamtleistung (W)	Kabelquerschnitt (mm <sup>2</sup> )
Maximal 3680	3 x 1.5

Die Erdleitung (gelb/grünes Kabel) muss 2 cm länger sein als die Phasenleitung und der Nullleiter (blaues und braunes Kabel).

## 2.3 Gebrauch



### WARNUNG!

Verletzungs-, Verbrennungs-, Stromschlag- oder Explosionsgefahr.

- Dieses Gerät ist ausschließlich zur Verwendung im Haushalt bestimmt.
- Nehmen Sie keine technischen Änderungen am Gerät vor.
- Die Lüftungsöffnungen dürfen nicht abgedeckt werden.
- Lassen Sie das Gerät bei Betrieb nicht unbeaufsichtigt.
- Schalten Sie das Gerät nach jedem Gebrauch aus.
- Gehen Sie beim Öffnen der Tür vorsichtig vor, wenn das Gerät in Betrieb ist. Es kann heiße Luft austreten.
- Bedienen Sie das Gerät nicht mit feuchten oder nassen Händen oder wenn es mit Wasser in Kontakt gekommen ist.
- Üben Sie keinen Druck auf die geöffnete Gerätetür aus.
- Benutzen Sie das Gerät nicht als Arbeits- oder Abstellfläche.
- Öffnen Sie die Gerätetür vorsichtig. Bei der Verwendung von Zutaten, die Alkohol enthalten, kann ein Alkohol-Luftgemisch entstehen.
- Achten Sie beim Öffnen der Tür darauf, dass keine Funken oder offenen Flammen in das Gerät gelangen.
- Laden Sie keine entflammaren Produkte oder Gegenstände, die mit entflammaren Produkten benetzt sind, in das Gerät und stellen Sie solche nicht in die Nähe oder auf das Gerät.



### WARNUNG!

Risiko von Schäden am Gerät.

- Um Beschädigungen und Verfärbungen der Emailbeschichtung zu vermeiden:

- Stellen Sie feuerfestes Geschirr oder andere Gegenstände nicht direkt auf den Boden des Geräts.
- Legen Sie keine Alufolie direkt auf den Boden des Garraums.
- Füllen Sie kein Wasser in das heiße Gerät.
- Lassen Sie nach Abschluss des Garvorgangs kein feuchtes Geschirr oder feuchte Speisen im Gerät stehen.
- Gehen Sie beim Herausnehmen oder Einsetzen des Zubehörs sorgfältig vor.
- Verfärbungen der Email- oder Edelstahlbeschichtung haben keine Auswirkung auf die Leistung des Geräts.
- Verwenden Sie für feuchte Kuchen das tiefe Blech. Fruchtsäfte können bleibende Flecken verursachen.
- Dieses Gerät ist nur zum Kochen bestimmt. Jeder andere Gebrauch ist als bestimmungsfremd anzusehen, zum Beispiel das Beheizen eines Raums.
- Die Backofentür muss beim Betrieb geschlossen sein.
- Ist das Gerät hinter einer Möbelfront (wie etwa einer Tür) installiert, achten Sie darauf, dass die Tür während des Gerätebetriebs nicht geschlossen wird. Hinter einer geschlossenen Möbelfront können sich Hitze und Feuchtigkeit ansammeln und das Gerät, das Gehäuse oder den Boden beschädigen. Schließen Sie die Möbelfront nicht, bevor das Gerät nach dem Gebrauch völlig abgekühlt ist.

## 2.4 Reinigung und Pflege



### WARNUNG!

Verletzungs-, Brandgefahr sowie Risiko von Schäden am Gerät.

- Schalten Sie das Gerät immer aus und ziehen Sie den Netzstecker aus der Steckdose, bevor Reinigungsarbeiten durchgeführt werden.
- Vergewissern Sie sich, dass das Gerät abgekühlt ist. Es besteht die Gefahr, dass die Glasscheiben brechen.
- Ersetzen Sie die Türglasscheiben umgehend, wenn sie beschädigt sind. Wenden Sie sich an einen autorisierten Kundendienst.

- Gehen Sie beim Aushängen der Tür vorsichtig vor. Die Tür ist schwer!
- Reinigen Sie das Gerät regelmäßig, um eine Verschlechterung des Oberflächenmaterials zu verhindern.
- Reinigen Sie das Geräts mit einem weichen, feuchten Tuch. Verwenden Sie ausschließlich Neutralreiniger. Benutzen Sie keine Scheuermittel, scheuernde Reinigungsschwämmchen, Lösungsmittel oder Metallgegenstände.
- Falls Sie ein Backofenspray verwenden, befolgen Sie die Sicherheitsanweisungen auf seiner Verpackung.

## 2.5 Innenbeleuchtung



**WARNUNG!**  
Stromschlaggefahr.

- Bezüglich der Lampe(n) in diesem Gerät und separat verkaufter Ersatzlampen: Diese Lampen müssen extremen physikalischen Bedingungen in Haushaltsgeräten standhalten, wie z.B. Temperatur, Vibration, Feuchtigkeit, oder sollen Informationen über den Betriebszustand des Gerätes anzeigen.

- Sie sind nicht für den Einsatz in anderen Geräten vorgesehen und nicht für die Raumbeleuchtung geeignet.
- Verwenden Sie nur Lampen mit der gleichen Leistung .

## 2.6 Service

- Wenden Sie sich zur Reparatur des Geräts an den autorisierten Kundendienst.
- Verwenden Sie ausschließlich Originalersatzteile.

## 2.7 Entsorgung



**WARNUNG!**  
Verletzungs- und  
Erstickengefahr.

- Trennen Sie das Gerät von der Stromversorgung.
- Schneiden Sie das Netzkabel in der Nähe des Geräts ab, und entsorgen Sie es.
- Entfernen Sie das Türschloss, um zu verhindern, dass sich Kinder oder Haustiere im Gerät einschließen.

# 3. MONTAGE



**WARNUNG!**  
Siehe Kapitel  
Sicherheitshinweise.

## 3.1 Montage



[www.youtube.com/electrolux](http://www.youtube.com/electrolux)  
[www.youtube.com/aeg](http://www.youtube.com/aeg)

How to install your AEG/Electrolux  
Oven - Column installation





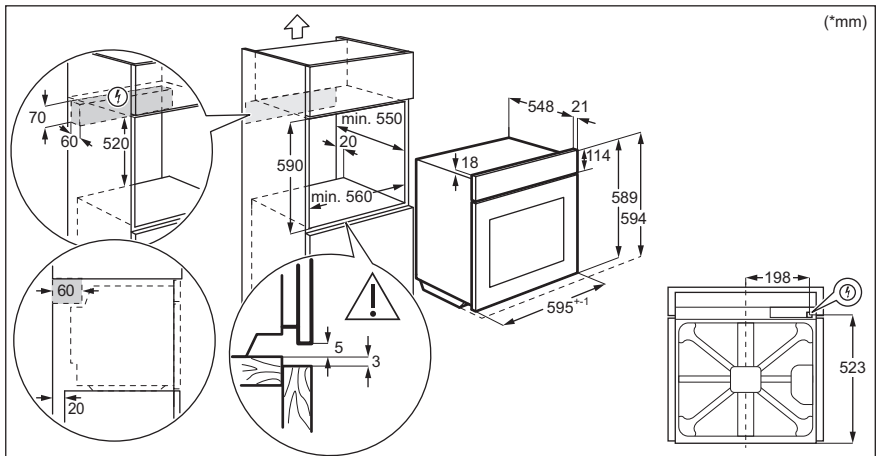
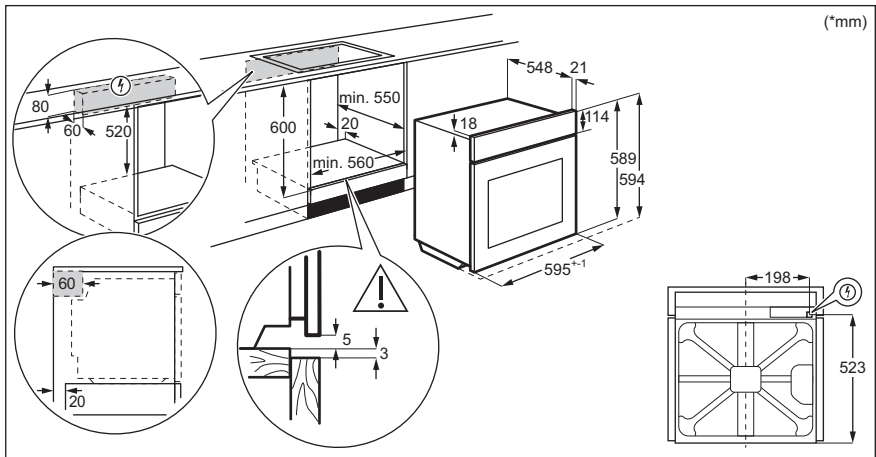

### 3.2 Befestigung des Ofens am Möbel

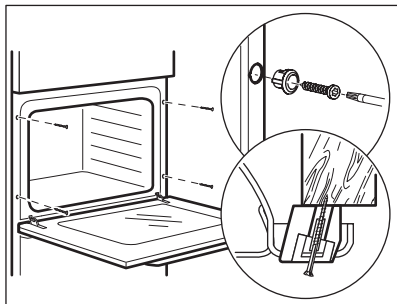

## 4. GERÄTEBESCHREIBUNG

### 4.1 Gesamtansicht

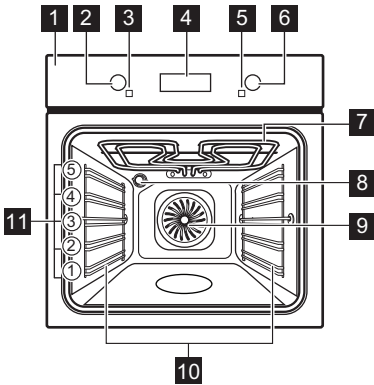

- 1 Bedienfeld
- 2 Einstellknopf für die Ofenfunktionen
- 3 Betriebskontrolllampe/-symbol
- 4 Display
- 5 Temperaturanzeige/-symbol
- 6 Einstellknopf (für die Temperatur)
- 7 Heizelement
- 8 Lampe
- 9 Ventilator
- 10 Einhängegitter, herausnehmbar
- 11 Einschubebenen

### 4.2 Zubehör

- **Kombirost**  
Für Kochgeschirr, Kuchenformen, Braten.
- **Backblech**  
Für Kuchen und Plätzchen.

- **Brat- und Fettpfanne**  
Zum Backen und Braten oder zum Auffangen von abtropfendem Fett.

## 5. BEDIENFELD

### 5.1 Versenkbare Knöpfe

Drücken Sie zum Benutzen des Geräts den Knopf. Der Knopf kommt dann heraus.

### 5.2 Sensorfelder/Tasten

—	Einstellen der Zeit.
⊙	Einstellen einer Uhrfunktion.
+	Einstellen der Zeit.

## 5.3 Display

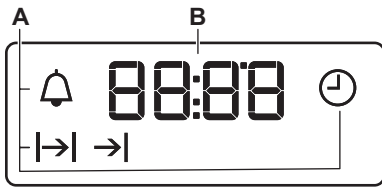

- A. Uhrfunktionen
- B. Timer

## 6. VOR DER ERSTEN INBETRIEBNAHME



### WARNUNG!

Siehe Kapitel  
Sicherheitshinweise.

### 6.1 Vor der ersten Inbetriebnahme

Der Backofen kann während des Aufheizens Geruch und Rauch verströmen. Stellen Sie sicher, dass der Raum belüftet ist.



Schritt 1



Schritt 2



Schritt 3

Stellen Sie die Uhrzeit ein	Reinigen Sie den Backofen	Heizen Sie den leeren Backofen vor
<p>1.  - zum Einstellen der Zeit drücken. Nach etwa 5 Sek. hört die Anzeige auf zu blinken und das Display zeigt die Zeit an.</p>	<p>1. Entfernen Sie alle Zubehörteile und die herausnehmbaren Einhängegitter aus dem Backofen.</p> <p>2. Feuchten Sie ein weiches Tuch mit warmem Wasser und etwas mildem Reinigungsmittel an, und reinigen Sie damit den Backofen und das Zubehör.</p>	<p>1. Stellen Sie die Höchsttemperatur für folgende Funktion ein:</p> <p> Zeit: 1 Std.</p> <p>2. Stellen Sie die Höchsttemperatur für folgende Funktion ein:</p> <p> Zeit: 15 min.</p> <p>3. Stellen Sie die Höchsttemperatur für folgende Funktion ein:</p> <p> Zeit: 15 min.</p>
<p>Schalten Sie den Backofen aus und warten Sie, bis er abgekühlt ist. Setzen Sie die Zubehörteile und die herausnehmbaren Einhängegitter in den Backofen.</p>		

## 7. TÄGLICHER GEBRAUCH







### WARNUNG!



Siehe Kapitel  
Sicherheitshinweise.

## 7.1 Einstellung: Ofenfunktion

<b>Schritt 1</b>	Drehen Sie den Backofen-Einstellknopf auf eine Ofenfunktion.
<b>Schritt 2</b>	Drehen Sie den Wahlknopf, um die Temperatur auszuwählen.
<b>Schritt 3</b>	Drehen Sie nach Beendigung des Garvorgangs die Knöpfe in die Aus-Position, um den Backofen auszuschalten.

## 7.2 Ofenfunktionen

Ofenfunktion	Anwendung
 Stellung Aus	Der Backofen ist ausgeschaltet.
 Backofenbeleuchtung	Einschalten der Lampe.
 Heißluft	Zum Backen auf bis zu drei Einschubebenen gleichzeitig und zum Dörren von Lebensmitteln. Stellen Sie eine 20 - 40 °C niedrigere Backofentemperatur als bei Ober-/Unterhitze ein.
 Feuchte Umluft	Diese Funktion ist entwickelt worden, um während des Garvorgangs Energie zu sparen. Wenn Sie diese Funktion nutzen, kann die Temperatur im Garraum von der eingestellten Temperatur abweichen. Die Wärmeleistung kann geringer sein. Weitere Informationen zu folgenden Themen finden Sie im Kapitel „Täglicher Gebrauch“: Feuchte Umluft.
 Unterhitze	Zum Backen von Kuchen mit knusprigen Böden und zum Einkochen von Lebensmitteln.

Ofenfunktion	Anwendung
 Grill	Zum Grillen dünner Lebensmittel und zum Toasten von Brot.
 Grillstufe 2	Zum Grillen dünner Lebensmittel in größeren Mengen und zum Toasten von Brot.
 Heißluftgrillen	Zum Braten großer Fleischstücke oder von Geflügel mit Knochen auf einer Ebene. Zum Gratinieren und Überbacken.
 Pizzastufe	Zum Backen von Pizza. Für ein intensives Überbacken und einen knusprigen Boden.
 Ober-/Unterhitze	Zum Backen und Braten auf einer Ebene.

## 7.3 Hinweise zu: Feuchte Umluft





Diese Funktion wurde zur Bestimmung der Energieeffizienzklasse und den Anforderungen an die umweltgerechte Gestaltung EU 65/2014 und EU 66/2014 verwendet. Tests gemäß EN 60350-1.

Die Backofentür sollte während des Garvorgangs geschlossen bleiben, damit die Funktion nicht unterbrochen wird. So wird gewährleistet, dass der Backofen mit der höchsten Energieeffizienz arbeitet.

Die Kochanleitungen finden Sie im Kapitel "Hinweise und Tipps", Feuchte Umluft. Allgemeine Empfehlungen zur Energieeinsparung finden Sie im Kapitel „Energieeffizienz“, Energie sparen.

## 8. UHRFUNKTIONEN

### 8.1 Uhrfunktionen

Uhrfunktion	Anwendung
 Uhrzeit	Zum Einstellen, Ändern oder Abfragen der Uhrzeit.
 Dauer	Einstellen der Einschaltdauer für den Backofen.
 Ende	Zum Einstellen, wann sich der Backofen ausschaltet.
 Zeitvorwahl	Kombinieren der Funktionen Dauer und Ende.
 Kurzzeit-Wecker	Zum Einstellen eines Countdowns. Diese Funktion wirkt sich nicht auf den Betrieb des Backofens aus. Sie können diese Funktion jederzeit und auch bei ausgeschaltetem Backofen einstellen.

### 8.2 Einstellung: Uhrfunktionen

#### Einstellung: Uhrzeit

 blinkt, wenn Sie den Backofen an die Stromversorgung anschließen, nach einem Stromausfall und wenn der Timer nicht eingestellt ist.

**+**, **-** – zum Einstellen der Zeit drücken.  
Nach etwa 5 Sek. hört die Anzeige auf zu blinken, und das Display zeigt die Zeit an.

#### Änderung: Uhrzeit



**Schritt 1**  – wiederholt drücken, um die Tageszeit zu ändern.  – beginnt zu blinken.

**Schritt 2** **+**, **-** – zum Einstellen der Zeit drücken.  
Nach etwa 5 Sek. hört die Anzeige auf zu blinken, und das Display zeigt die Zeit an.

#### Einstellung: Dauer

**Schritt 1** Stellen Sie eine Ofenfunktion und die Temperatur ein.

**Schritt 2**  – wiederholt drücken.  – beginnt zu blinken.



**Schritt 3** **+**, **-** – zum Einstellen der Dauer drücken.  
Im Display wird Folgendes angezeigt:   
 – blinkt, wenn die eingestellte Zeit abgelaufen ist. Der Signalton ertönt, und der Backofen wird ausgeschaltet.





**Schritt 4** Drücken Sie eine beliebige Taste, um das Signal abzustellen.

**Schritt 5** Drehen Sie den Knopf in die Aus-Position.

## Einstellung: Ende

**Schritt 1** Stellen Sie eine Ofenfunktion und die Temperatur ein.

**Schritt 2**  – wiederholt drücken.  – beginnt zu blinken.

**Schritt 3** ,  – zum Einstellen der Zeit drücken.  
Im Display wird Folgendes angezeigt:   
 – blinkt, wenn die eingestellte Zeit abgelaufen ist. Der Signalton ertönt, und der Backofen wird ausgeschaltet.



**Schritt 4** Drücken Sie eine beliebige Taste, um das Signal abzustellen.

**Schritt 5** Drehen Sie den Knopf in die Aus-Position.



## Einstellung: Zeitvorwahl

**Schritt 1** Stellen Sie eine Ofenfunktion und die Temperatur ein.

**Schritt 2**  – wiederholt drücken.  – beginnt zu blinken.

**Schritt 3** ,  – zum Einstellen der Zeit folgende Funktion drücken: Dauer.

**Schritt 4** Drücken Sie: .

**Schritt 5** ,  – zum Einstellen der Zeit folgende Funktion drücken: Ende.



**Schritt 6** Drücken Sie: .



Der Signalton ertönt zur eingestellten Zeit, und der Backofen wird ausgeschaltet.

**Schritt 7** Drücken Sie eine beliebige Taste, um das Signal abzustellen.

**Schritt 8** Drehen Sie den Knopf in die Aus-Position.

## Einstellung: Kurzzeit-Wecker

**Schritt 1**  – wiederholt drücken.  – beginnt zu blinken.

**Schritt 2** ,  – zum Einstellen der Zeit drücken.  
Die Funktion startet automatisch nach 5 Sekunden.  
Nach Ablauf der eingestellten Zeit ertönt der Signalton.

**Schritt 3** Drücken Sie eine beliebige Taste, um das Signal abzustellen.

**Schritt 4** Drehen Sie den Knopf in die Aus-Position.

## Abbrechen: Uhrfunktionen

**Schritt 1**  – wiederholt drücken, bis das Symbol der Uhrfunktion zu blinken anfängt.

**Schritt 2** Drücken und halten Sie: .

Die Uhrfunktion wird nach einigen Sekunden ausgeschaltet.

## 9. VERWENDUNG DES ZUBEHÖRS



### **WARNUNG!**

Siehe Kapitel  
Sicherheitshinweise.

dienen auch als Kippsicherung. Durch den umlaufend erhöhten Rand des Rosts ist das Kochgeschirr gegen Abrutschen vom Rost gesichert.

### 9.1 Einsetzen des Zubehörs

Die kleine Einkerbung auf der Oberseite erhöht die Sicherheit. Diese Einkerbungen

#### **Kombirost:**

Schieben Sie den Kombirost zwischen die Führungsschienen der Einhängegitter mit den Füßen nach unten zeigend.

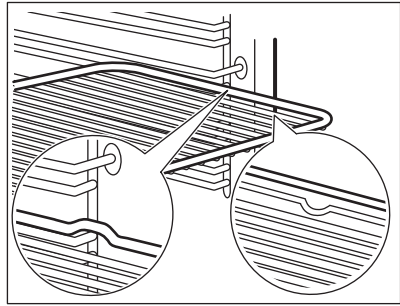

#### **Backblech /Auflauffanne:**

Schieben Sie das Blech zwischen die Führungsstäbe der Einhängegitter.

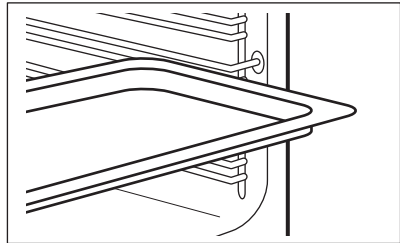

#### **Kombirost, Backblech /Auflauffanne:**

Schieben Sie das Backblech zwischen die Führungsstäbe der Einhängegitter und dem Kombirost auf die Führungsstäbe darüber.

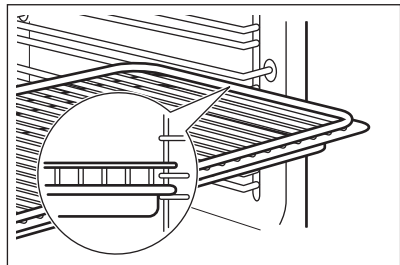

## 10. ZUSATZFUNKTIONEN

### 10.1 Kühlgebläse

Wenn der Backofen in Betrieb ist, wird das Kühlgebläse automatisch eingeschaltet, um die Ofenoberflächen zu kühlen. Wenn Sie den Backofen ausschalten kann das Kühlgebläse weiter laufen, bis der Ofen abgekühlt ist.

### 10.2 Sicherheitsthermostat

Ein unsachgemäßer Gebrauch des Ofens oder defekte Bestandteile können zu einer

gefährlichen Überhitzung führen. Um dies zu verhindern, ist der Backofen mit einem Sicherheitsthermostat ausgestattet, der die Stromzufuhr unterbrechen kann. Die Wiedereinschaltung des Backofens erfolgt automatisch bei Temperaturabfall.

## 11. TIPPS UND HINWEISE



Siehe Kapitel Sicherheitshinweise.

### 11.1 Garempfehlungen

Der Backofen hat fünf Einschubebenen.

Die Ebenen werden vom Boden des Backofens aus gezählt.

Ihr Backofen backt oder brät unter Umständen anders als Ihr früherer Backofen. Die nachstehenden Tabellen enthalten die standardmäßigen Temperatureinstellungen, die Gardauer und die Einschubebene.

Finden Sie für ein bestimmtes Rezept keine konkreten Angaben, orientieren Sie sich an einem ähnlichem Rezept.

Der Backofen ist mit einem speziellen System ausgestattet, das die Luft zirkulieren lässt und den Dampf ständig wiederverwendet. Mit diesem System macht das Garen mit Dampf Ihre Speisen innen weich und außen knusprig. So verringert sich die Gardauer und der Energieverbrauch.

#### **Backen von Kuchen**

Die Backofentür nicht öffnen, bevor 3/4 der Backzeit abgelaufen ist.

Wenn Sie zwei Backbleche gleichzeitig nutzen, lassen Sie eine Ebene dazwischen frei.

#### **Garen von Fleisch und Fisch**

Setzen Sie bei Speisen mit hohem Fettgehalt eine Brat- und Fettpfanne ein, damit keine hartnäckigen Flecken im Backofen verbleiben.

Lassen Sie das Fleisch vor dem Anschneiden etwa 15 Minuten ruhen, damit der Fleischsaft nicht ausläuft.

Um die Rauchbildung beim Braten im Backofen zu vermindern, geben Sie etwas Wasser in die Brat- und Fettpfanne. Um die Kondensierung des Rauchs zu vermeiden, geben Sie jedes Mal, wenn das Wasser verdampft ist, erneut Wasser in die Brat- und Fettpfanne.







#### **Garzeiten**

Die Garzeiten hängen von der Art des Garguts, seiner Konsistenz und der Menge ab.







Beobachten Sie den Garfortschritt. Finden Sie heraus, welche Geräteeinstellungen (Garstufe, Gardauer, usw.) für Ihr Kochgeschirr, Ihre Rezepte und die von Ihnen zubereiteten Garmengen am besten geeignet sind.



## 11.2 Backen und Braten







 <b>KU- CHEN</b>	Ober-/Unterhitze		Heißluft		 (Min.)	
	 (°C)		 (°C)			
Rührteig	170	2	160	3 (2 und 4)	45 – 60	Kuchenform
Mürbeteig	170	2	160	3 (2 und 4)	20 – 30	Kuchenform
Buttermilch-Käsekuchen	170	1	165	2	60 – 80	Kuchenform, Ø 26 cm
Strudel/Stollen	175	3	150	2	60 – 80	Backblech
Marmeladentorte	170	2	165	2	30 – 40	Kuchenform, Ø 26 cm
Christstollen, Heizen Sie den leeren Backofen vor	160	2	150	2	90 – 120	Kuchenform, Ø 20 cm
Rosinenkuchen, Heizen Sie den leeren Backofen vor	175	1	160	2	50 – 60	Brotform
Muffins	170	3	140 – 150	3	20 – 30	Backblech
Muffins, zwei Ebenen	–	–	140 – 150	2 und 4	25 – 35	Backblech
Muffins, drei Ebenen	–	–	140 – 150	1, 3 und 5	30 – 45	Backblech
Kekse	140	3	140 – 150	3	30 – 35	Backblech
Kekse, zwei Ebenen	–	–	140 – 150	2 und 4	35 – 40	Backblech
Kekse, drei Ebenen	–	–	140 – 150	1, 3 und 5	35 – 45	Backblech
Baiser	120	3	120	3	80 – 100	Backblech
Baiser, zwei Ebenen, Heizen Sie den leeren Backofen vor	–	–	120	2 und 4	80 – 100	Backblech
Brötchen, Heizen Sie den leeren Backofen vor	190	3	190	3	12 – 20	Backblech
Eclairs	190	3	170	3	25 – 35	Backblech
Eclairs, zwei Ebenen	–	–	170	2 und 4	35 – 45	Backblech
Törtchen	180	2	170	2	45 – 70	Kuchenform, Ø 20 cm
Üppiger Obstkuchen	160	1	150	2	110 – 120	Kuchenform, Ø 24 cm

Heizen Sie den leeren Backofen vor.

 <b>BROT UND PIZZA</b>	<b>Ober-/Unterhitze</b>		<b>Heißluft</b>		 (Min.)	
	 (°C)		 (°C)			
Weißbrot, 1 - 2 Stück, je 0,5 kg	190	1	190	1	60 – 70	–
Roggenbrot, Vorheizen ist nicht erforderlich	190	1	180	1	30 – 45	Brotform
Brot/Brötchen, 6 - 8 Brötchen	190	2	180	2 (2 und 4)	25 – 40	Backblech
Pizza	230 – 250	1	230 – 250	1	10 – 20	Emailliertes Blech
Scones	200	3	190	3	10 – 20	Backblech





Heizen Sie den leeren Backofen vor.





Verwenden Sie die Kuchenform.







 <b>OBSTKUCHEN</b>	<b>Ober-/Unterhitze</b>		<b>Heißluft</b>		 (Min.)
	 (°C)		 (°C)		
Nudelaufauf, Vorheizen ist nicht erforderlich	200	2	180	2	40 – 50
Gemüseaufauf, Vorheizen ist nicht erforderlich	200	2	175	2	45 – 60
Quiche	180	1	180	1	50 – 60
Lasagne	180 – 190	2	180 – 190	2	25 – 40
Cannelloni	180 – 190	2	180 – 190	2	25 – 40

Nutzen Sie die zweite Einschubebene.





Verwenden Sie den Kombirost.

 <b>FLEISCH</b>	<b>Ober-/Unterhitze</b>		<b>Heißluft</b>	
	 (°C)		 (°C)	 (Min.)
Rind	200		190	50 – 70
Schweinefleisch	180		180	90 – 120
Kalb	190		175	90 – 120
Roastbeef, englisch, blutig	210		200	50 – 60

 FLEISCH	Ober-/Unterhitze  (°C)	Heißluft  (°C)	 (Min.)
Roastbeef, englisch, rosa	210	200	60 – 70
Roastbeef, englisch, durch	210	200	70 – 75

 FLEISCH	Ober-/Unterhitze  (°C)		Heißluft  (°C)		 (Min.)
Schweineschulter, mit Schwarte	180	2	170	2	120 – 150
Schweinschaxe, 2 Stück	180	2	160	2	100 – 120
Lammkeule	190	2	175	2	110 – 130
Hähnchen, ganz	220	2	200	2	70 – 85
Pute, ganz	180	2	160	2	210 – 240
Ente, ganz	175	2	220	2	120 – 150
Gans, ganz	175	2	160	1	150 – 200
Kaninchen, in Stücke geschnitten	190	2	175	2	60 – 80
Kaninchen, in Stücke geschnitten	190	2	175	2	150 – 200
Fasan, ganz	190	2	175	2	90 – 120

Nutzen Sie die zweite Einschubebene.

 FISCH	Ober-/Unterhitze  (°C)	Heißluft  (°C)	 (Min.)
Forelle / Seebrasse, 3 - 4 Fische	190	175	40 – 55
Thunfisch / Lachs, 4 - 6 Filets	190	175	35 – 60

### 11.3 Grill

Leeren Backofen vorheizen.

Nutzen Sie die vierte Einschubebene.

Grillen Sie bei maximaler Temperatureinstellung.



(Min.)  
Erste Seite



(Min.)  
Zweite Seite

	(kg)	(Min.) Erste Seite	(Min.) Zweite Seite
Filetsteaks, 4 Stück	0.8	12 - 15	12 - 14
Rindersteak, 4 Stück	0.6	10 - 12	6 - 8
Würstchen, 8	-	12 - 15	10 - 12
Schweinekoteletts, 4 Stück	0.6	12 - 16	12 - 14
Hähnchen, halbiert, 2	1	30 - 35	25 - 30
Spieße, 4	-	10 - 15	10 - 12
Hähnchenbrust, 4 Stück	0.4	12 - 15	12 - 14
Frikadellen, 6	0.6	20 - 30	-
Fischfilet, 4 Stück	0.4	12 - 14	10 - 12
Belegte Toastbrote, 4 - 6	-	5 - 7	-
Toast, 4 - 6	-	2 - 4	2 - 3

## 11.4 Heißluftgrillen

Leeren Backofen vorheizen.

Nutzen Sie die erste oder zweite Einschubebene.

Multiplizieren Sie zur Berechnung der Garzeit die Zeit, die in der Tabelle unten angegeben ist, mit der Dicke des Filets in Zentimetern.

 **RIND-  
FLEISCH**



	(°C)	(Min.)
Roastbeef/Filet, blutig	190 - 200	5 - 6
Roastbeef/Filet, rosa	180 - 190	6 - 8
Roastbeef/Filet, durch	170 - 180	8 - 10

 **SCHWEINE-  
FLEISCH**



	(°C)	(Min.)
Schulter / Nacken / Schinkenstück, 1 - 1,5 kg	160 - 180	90 - 120
Koteletts / Rippchen, 1 - 1,5 kg	170 - 180	60 - 90
Hackbraten, 0,75 - 1 kg	160 - 170	50 - 60

 **SCHWEINE-  
FLEISCH**



	(°C)	(Min.)
Schweinhaxe, vorgegart, 0,75 - 1 kg	150 - 170	90 - 120

 **KALB**









	(°C)	(Min.)
Kalbsbraten, 1 kg	160 - 180	90 - 120
Kalbshaxe, 1,5 - 2 kg	160 - 180	120 - 150

 **LAMM**



	(°C)	(Min.)
Lammkeule / Lammbraten, 1 - 1,5 kg	150 - 170	100 - 120
Lammrücken, 1 - 1,5 kg	160 - 180	40 - 60

 <b>GEFLÜGEL</b>	 (°C)	 (Min.)
Geflügelteile, je 0,2 - 0,25 kg	200 - 220	30 - 50
Hähnchen, halbiert, je 0,4 - 0,5 kg	190 - 210	35 - 50
Hähnchen, Poularde, 1 - 1,5 kg	190 - 210	50 - 70
Ente, 1,5 - 2 kg	180 - 200	80 - 100
Gans, 3,5 - 5 kg	160 - 180	120 - 180
Pute, 2,5 - 3,5 kg	160 - 180	120 - 150
Pute, 4 - 6 kg	140 - 160	150 - 240

 <b>FISCH, GE-DÄMPFT</b>	 (°C)	 (Min.)
Fisch, 1 - 1,5 kg	210 - 220	40 - 60

### 11.5 Dörren - Heißluft



Bleche mit fettbeständigem Papier oder Backpapier abdecken.

Um ein besseres Ergebnis zu erzielen, schalten Sie den Backofen nach der Hälfte der Trockenzeit aus, öffnen Sie die Tür und



lassen Sie ihn eine Nacht abkühlen, um das Trocknen abzuschließen.

Nutzen Sie für 1 Blech die dritte Einschubebene.

Für 2 Bleche verwenden Sie die erste und vierte Einschubebene.

 <b>GEMÜSE</b>	 (°C)	 (Std.)
Bohnen	60 - 70	6 - 8
Paprika	60 - 70	5 - 6
Suppengemüse	60 - 70	5 - 6
Pilze	50 - 60	6 - 8
Kräuter	40 - 50	2 - 3

Stellen Sie die Temperatur auf 60 - 70 °C ein.

 <b>OBST</b>	 (Std.)
Pflaumen	8 - 10
Aprikosen	8 - 10
Apfelscheiben	6 - 8
Birnen	6 - 9

### 11.6 Feuchte Umluft - Empfohlenes Zubehör

Verwenden Sie die dunklen und nicht reflektierenden Formen und Behälter. Sie haben eine bessere Wärmeabsorption als helle Farbe und reflektierende Schüsseln.



**Pizzapfanne**

Dunkel, nicht reflektierend  
28 cm Durchmesser

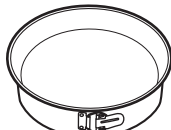

**Backform**

Dunkel, nicht reflektierend  
26 cm Durchmesser



**Förmchen**

Keramikform  
8 cm Durchmesser,  
5 cm Höhe







**Tortenbodenform**

Dunkel, nicht reflektierend  
28 cm Durchmesser







### 11.7 Feuchte Umluft

Beachten Sie für beste Ergebnisse die unten in der Tabelle aufgeführten Empfehlungen.

		 (°C)		 (Min.)
Brötchen, süß, 12 Stück	Backblech oder tiefes Blech	175	3	40 - 50
Brötchen, 9 Stück	Backblech oder tiefes Blech	180	2	35 - 45
Pizza, gefroren, 0,35 kg	Kombirost	180	2	45 - 55
Biskuitrolle	Backblech oder tiefes Blech	170	2	30 - 40
Brownie	Backblech oder tiefes Blech	170	2	45 - 50
Soufflé, 6 Stück	Keramikförmchen auf Kombirost	190	3	45 - 55
Biskuitboden	Biskuitform auf Kombirost	180	2	35 - 45
Englischer Sandwichkuchen à la Victoria	Backform auf Kombirost	170	2	35 - 50
Fisch, pochiert, 0,3 kg	Backblech oder tiefes Blech	180	2	35 - 45
Fisch, 0,2 kg	Backblech oder tiefes Blech	180	3	25 - 35
Fischfilet, 0,3 kg	Pizzapfanne auf Kombirost	170	3	30 - 40
Fleisch, pochiert, 0,25 kg	Backblech oder tiefes Blech	180	3	35 - 45
Schaschlik, 0,5 kg	Backblech oder tiefes Blech	180	3	40 - 50
Plätzchen, 16 Stück	Backblech oder tiefes Blech	150	2	30 - 45
Makronen, 20 Stück	Backblech oder tiefes Blech	180	2	45 - 55
Muffins, 12 Stück	Backblech oder tiefes Blech	170	2	30 - 40
Kleingebäck, pikant, 16 Stück	Backblech oder tiefes Blech	170	2	35 - 45
Mürbeteigplätzchen, 20 Stück	Backblech oder tiefes Blech	150	2	40 - 50
Törtchen, 8 Stück	Backblech oder tiefes Blech	170	2	30 - 40
Gemüse, pochiert, 0,4 kg	Backblech oder tiefes Blech	180	2	35 - 45
Vegetarisches Omelett	Pizzapfanne auf Kombirost	180	3	35 - 45
Mediterranes Gemüse, 0,7 kg	Backblech oder tiefes Blech	180	4	35 - 45

## 11.8 Informationen für Prüfinstitute

Tests gemäß IEC 60350-1.

						
				(°C)	(Min.)	
Törtchen, 20 pro Blech	Ober-/Unterhitze	Backblech	3	170	20 - 30	-
Törtchen, 20 pro Blech	Heißluft	Backblech	3	150 - 160	20 - 35	-
Törtchen, 20 pro Blech	Heißluft	Backblech	2 und 4	150 - 160	20 - 35	-
Apfelkuchen, 2 Formen à Ø 20 cm	Ober-/Unterhitze	Kombirost	2	180	70 - 90	-
Apfelkuchen, 2 Formen à Ø 20 cm	Heißluft	Kombirost	2	160	70 - 90	-
Biskuit, Kuchenform Ø 26 cm	Ober-/Unterhitze	Kombirost	2	170	40 - 50	Backofen 10 Min. vorheizen.
Biskuit, Kuchenform Ø 26 cm	Heißluft	Kombirost	2	160	40 - 50	Backofen 10 Min. vorheizen.
Biskuit, Kuchenform Ø 26 cm	Heißluft	Kombirost	2 und 4	160	40 - 60	Backofen 10 Min. vorheizen.
Mürbeteiggebäck	Heißluft	Backblech	3	140 - 150	20 - 40	-
Mürbeteiggebäck	Heißluft	Backblech	2 und 4	140 - 150	25 - 45	-
Mürbeteiggebäck	Ober-/Unterhitze	Backblech	3	140 - 150	25 - 45	-
Toast, 4 - 6 Stück	Grill	Kombirost	4	Max.	2 - 3 Minuten auf der ersten Seite, 2 - 3 Minuten auf der zweiten Seite	Backofen 3 Min. vorheizen.
Hamburger aus Rindfleisch, 6 Stück, 0,6 kg	Grill	Kombirost und Fettpfanne	4	Max.	20 - 30	Kombirost in die vierte und Fettpfanne in die dritte Einschubebene des Backofens einschieben. Wenden Sie das Lebensmittel nach der Hälfte der Gardauer. Backofen 3 Min. vorheizen.

## 12. REINIGUNG UND PFLEGE



### WARNUNG!

Siehe Kapitel  
Sicherheitshinweise.

### 12.1 Hinweise zur Reinigung



Feuchten Sie ein weiches Tuch mit warmem Wasser und etwas mildem Reinigungsmittel an, und reinigen Sie damit die Vorderseite des Backofens. Reinigen und überprüfen Sie die Türdichtung um den Garraumrahmen.

Reinigen Sie die Metalloberflächen mit einer Reinigungslösung.

#### Reinigungsmittel

Reinigen Sie Flecken mit einem milden Reinigungsmittel.



#### Täglicher Gebrauch

Reinigen Sie den Garraum nach jedem Gebrauch. Fettansammlungen oder andere Speisereste könnten einen Brand verursachen.

Es kann sich Feuchtigkeit im Ofen oder an den Glasscheiben der Tür niederschlagen. Um die Kondensation zu reduzieren, schalten Sie den Backofen immer 10 Minuten vor dem Garen ein. Lassen Sie die Speisen nicht länger als 20 Minuten im Backofen stehen. Trocknen Sie den Garraum nach jedem Gebrauch mit einem weichen Tuch ab.



#### Zubehör

Reinigen Sie alle Zubehörteile nach jedem Gebrauch und lassen Sie sie trocknen. Feuchten Sie ein weiches Tuch mit warmem Wasser und einem milden Reinigungsmittel an. Reinigen Sie die Zubehörteile nicht im Geschirrspüler.

Reinigen Sie das Zubehör mit Antihafbeschichtung nicht mit Scheuermitteln oder scharfkantigen Gegenständen.

### 12.2 Entfernen: Einhängegitter

Entfernen Sie Einhängegitter zur Reinigung des Backofens.

**Schritt 1** Schalten Sie den Backofen aus und warten Sie, bis er abgekühlt ist.

**Schritt 2** Ziehen Sie das Einhängegitter vorne von der Seitenwand weg.

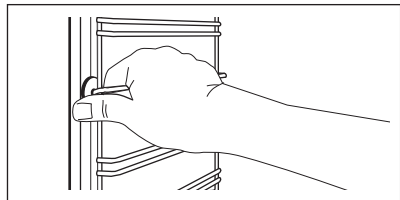

**Schritt 3** Ziehen Sie das Einhängegitter hinten von der Seitenwand weg und nehmen Sie es heraus.

**Schritt 4** Führen Sie zum Einsetzen der Einhängegitter die oben aufgeführten Schritte in umgekehrter Reihenfolge durch.

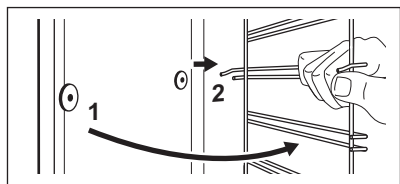



## 12.3 Aus- und Einbau der: Tür

Die Backofentür hat drei Glasscheiben. Die Backofentür und die inneren Glasscheiben können zur Reinigung herausgenommen werden. Lesen Sie die gesamte Anleitung „Aus- und Einbauen der Tür“, bevor Sie die Glasscheiben entfernen.



### VORSICHT!

Benutzen Sie den Backofen nicht ohne die Glasscheiben.

**Schritt 1** Öffnen Sie die Backofentür vollständig und suchen Sie nach dem Scharnier auf der rechten Seite der Tür.

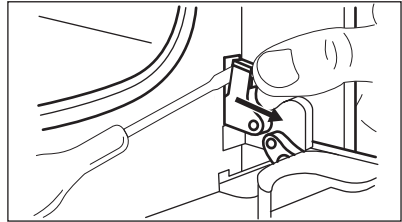

**Schritt 2** Benutzen Sie einen Schraubenzieher, um den rechten Scharnierhebel anzuheben und zu drehen.

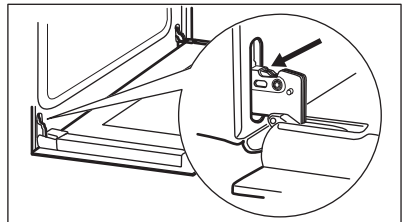

**Schritt 3** Fassen Sie das Scharnier auf der linken Seite der Tür an.

**Schritt 4** Heben und drehen Sie den Hebel am linken Scharnier vollständig.

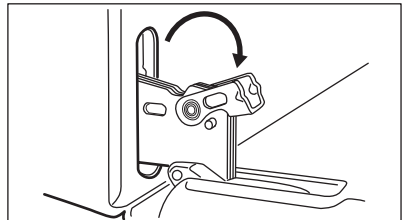

**Schritt 5** Schließen Sie die Backofentür halb bis zur ersten Raststellung. Anschließend heben und ziehen Sie die Tür nach vorn aus der Aufnahme heraus.

**Schritt 6** Legen Sie die Backofentür auf ein weiches Tuch auf einer stabilen Fläche.

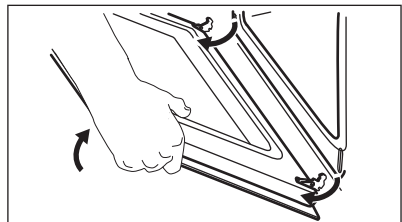

**Schritt 7** Fassen Sie die Türabdeckung (B) an der Oberkante der Tür an beiden Seiten an. Drücken Sie sie nach innen, um den Klippverschluss zu lösen.

**Schritt 8** Ziehen Sie die Türabdeckung nach vorn, um sie abzunehmen.

**Schritt 9** Halten Sie die Oberkanten der Türglasscheiben fest und ziehen Sie sie vorsichtig nacheinander heraus. Beginnen Sie mit der obersten Glasscheibe. Achten Sie darauf, dass die Glasscheiben vollständig aus den Halterungen gezogen werden.

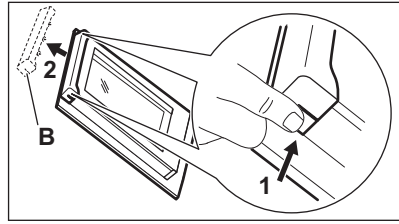

**Schritt 10** Reinigen Sie die Glasscheiben mit Wasser und Spülmittel. Trocknen Sie die Glasscheiben sorgfältig ab. Reinigen Sie die Glasscheiben nicht im Geschirrspüler.

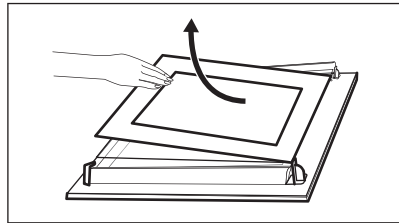

**Schritt 11** Setzen Sie nach der Reinigung die Glasscheiben und die Backofentür ein.

Achten Sie beim Wiedereinsetzen der Glasscheiben (A und B) auf die richtige Reihenfolge. Überprüfen Sie das Symbol/den Aufdruck auf der Seite der Glasscheibe. Jede Glasscheibe sieht anders aus, um den Aus- und Einbau zu erleichtern. Bei korrektem Einbau macht die Türabdeckung ein Klickgeräusch. Achten Sie darauf, die mittlere Glasscheibe richtig in die Aufnahmen einzusetzen.

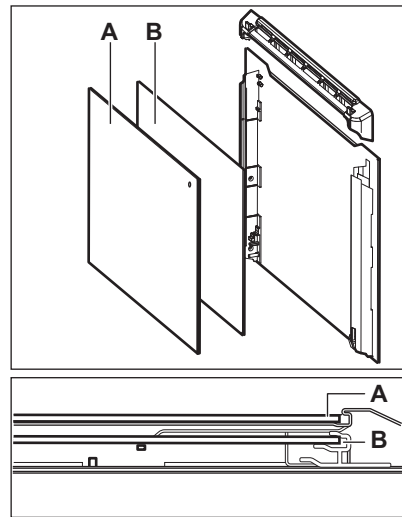

## 12.4 Austausch: Lampe



**WARNUNG!**  
Stromschlaggefahr.  
Die Lampe kann heiß sein.

Halten Sie die Halogenlampe stets mit einem Tuch, um zu verhindern, dass Fettrückstände auf der Lampe einbrennen.

### Bevor Sie die Lampe austauschen:

#### Schritt 1

Schalten Sie den Backofen aus.  
Warten Sie, bis der Ofen kalt ist.

#### Schritt 2

Trennen Sie den Ofen von der Netzversorgung.

#### Schritt 3

Breiten Sie ein Tuch auf dem Garraumboden aus.

## Hintere Lampe

**Schritt 1** Drehen Sie die Glasabdeckung und nehmen Sie sie ab.

**Schritt 2** Reinigen Sie die Glasabdeckung.

**Schritt 3** Ersetzen Sie die Lampe durch eine geeignete, bis 300 °C hitzebeständige Lampe.

**Schritt 4** Bringen Sie die Glasabdeckung wieder an.

## 13. FEHLERSUCHE



### WARNUNG!

Siehe Kapitel  
Sicherheitshinweise.

### 13.1 Was tun, wenn...

In allen Fällen, die nicht in dieser Tabelle aufgeführt sind, wenden Sie sich bitte an einen autorisierten Kundendienst.

Störung	Prüfen Sie, ob...
Der Backofen nicht heizt.	Die Sicherung durchgebrannt ist.
Die Türdichtung beschädigt ist.	Benutzen Sie den Ofen nicht. Wenden Sie sich an den autorisierten Kundendienst.

Störung	Prüfen Sie, ob...
Das Display „12.00“ anzeigt.	Es einen Stromausfall gab. Stellen Sie die Uhrzeit ein.
Die Lampe nicht funktioniert.	Die Lampe durchgebrannt ist.

### 13.2 Servicedaten

Wenn Sie das Problem nicht selbst lösen können, wenden Sie sich an Ihren Händler oder einen autorisierten Kundendienst.

Die vom Kundendienst benötigten Daten finden Sie auf dem Typenschild. Das Typenschild befindet sich am Frontrahmen des Garraums. Entfernen Sie das Typenschild nicht vom Garraum.

### Wir empfehlen, hier folgende Daten zu notieren:

Modell (MOD.) .....

Produktnummer (PNC) .....

Seriennummer (S.N.) .....

## 14. ENERGIEEFFIZIENZ

### 14.1 Produktinformationen und Produktdatenblatt\*

Herstellername	AEG
Modellidentifikation	BEE431011M 949496317
Energieeffizienzindex	95.3
Energieeffizienzklasse	A
Energieverbrauch bei Standardbeladung, Ober-/Unterhitze	0.93 kWh/Programm

Energieverbrauch bei Standardbelastung, Umluft	0.81 kWh/Programm
Anzahl der Garräume	1
Wärmequelle	Strom
Fassungsvermögen	72 l
Backofentyp	Einbau-Backofen
Gewicht	30.2 kg

\* Für die Europäische Union gemäß EU-Richtlinien 65/2014 und 66/2014.

Für die Republik Weißrussland gemäß STB 2478-2017, Anhang G; STB 2477-2017, Anlagen A und B.

Für die Ukraine gemäß 568/32020.

Die Energieeffizienzklasse gilt nicht für Russland.

EN 60350-1 - Elektrische Kochgeräte für den Hausgebrauch - Teil 1: Herde, Backöfen, Dampfgarer und Grillgeräte - Verfahren zur Messung der Gebrauchseigenschaften.

## 14.2 Energie sparen



Der Backofen verfügt über Funktionen, mit deren Hilfe Sie beim täglichen Kochen Energie sparen können.

Achten Sie darauf, dass die Backofentür während des Ofenbetriebs geschlossen ist. Die Backofentür darf während des Garvorgangs nicht zu oft geöffnet werden. Halten Sie die Türdichtung sauber und stellen Sie sicher, dass sie sich fest in der richtigen Position befindet.

Verwenden Sie Kochgeschirr aus Metall, um mehr Energie zu sparen.

Heizen Sie, wenn möglich, den Backofen nicht vor.

Halten Sie die Unterbrechungen beim Backen so kurz wie möglich, wenn Sie mehrere Speisen gleichzeitig zubereiten.

### Garen mit Heißluft

Nutzen Sie, wenn möglich, die Garfunktionen mit Heißluft, um Energie zu sparen.

### Restwärme

Beträgt die Garzeit mehr als 30 Minuten, reduzieren Sie die Ofentemperatur 3 - 10 Min. vor Ablauf des Garvorgangs. Durch die Restwärme des Backofens werden die Speisen weiter gegart.

Nutzen Sie die Restwärme, um andere Speisen aufzuwärmen.

### Warmhalten von Speisen

Wählen Sie die niedrigste Temperatureinstellung, wenn Sie die Restwärme zum Warmhalten von Speisen nutzen möchten.

### Feuchte Umluft

Diese Funktion ist entwickelt worden, um während des Garvorgangs Energie zu sparen.

## 15. UMWELTTIPPS

Recyceln Sie Materialien mit dem Symbol

 Entsorgen Sie die Verpackung in den entsprechenden Recyclingbehältern.

Recyceln Sie zum Umwelt- und Gesundheitsschutz elektrische und elektronische Geräte. Entsorgen Sie Geräte

mit diesem Symbol  nicht mit dem Hausmüll. Bringen Sie das Gerät zu Ihrer örtlichen Sammelstelle oder wenden Sie sich an Ihr Gemeindeamt.

## POUR DES RÉSULTATS PARFAITS

Merci d'avoir choisi ce produit AEG. Nous l'avons conçu pour qu'il vous offre des performances irréprochables pendant de nombreuses années, en intégrant des technologies innovantes vous simplifiant la vie – fonctions que vous ne trouverez peut-être pas sur des appareils ordinaires. Veuillez prendre quelques instants pour lire cette notice afin d'utiliser au mieux votre appareil.

**Consultez notre site pour :**



Obtenir des conseils d'utilisation, des brochures, un dépanneur, des informations sur le service et les réparations :

**[www.aeg.com/support](http://www.aeg.com/support)**



Enregistrer votre produit pour un meilleur service :

**[www.registreaeg.com](http://www.registreaeg.com)**



Acheter des accessoires, consommables et pièces de rechange d'origine pour votre appareil :

**[www.aeg.com/shop](http://www.aeg.com/shop)**

## SERVICE ET ASSISTANCE À LA CLIENTÈLE

N'utilisez que des pièces de rechange d'origine.

Avant de contacter notre centre de service agréé, assurez-vous de disposer des informations suivantes : Modèle, PNC, numéro de série.

Ces informations figurent sur la plaque signalétique.

 Avertissement/Consignes de sécurité

 Informations générales et conseils

 Informations environnementales

Sous réserve de modifications.

## TABLE DES MATIÈRES

1. INFORMATION SUR LA SÉCURITÉ.....	54
2. CONSIGNES DE SÉCURITÉ.....	55
3. INSTALLATION.....	58
4. DESCRIPTION DE L'APPAREIL.....	60
5. BANDEAU DE COMMANDE.....	60
6. AVANT LA PREMIÈRE UTILISATION.....	61
7. UTILISATION QUOTIDIENNE.....	61
8. FONCTIONS DE L'HORLOGE.....	62
9. UTILISATION DES ACCESSOIRES.....	64
10. FONCTIONS SUPPLÉMENTAIRES.....	65
11. CONSEILS ET ASTUCES.....	66
12. ENTRETIEN ET NETTOYAGE.....	74
13. DÉPANNAGE.....	77
14. RENDEMENT ÉNERGÉTIQUE.....	78

## 1. ⚠ INFORMATION SUR LA SÉCURITÉ

Avant d'installer et d'utiliser cet appareil, lisez soigneusement les instructions fournies. Le fabricant ne pourra être tenu pour responsable des blessures et dégâts résultant d'une mauvaise installation ou utilisation. Conservez toujours les instructions dans un lieu sûr et accessible pour vous y référer ultérieurement.

### 1.1 Sécurité des enfants et des personnes vulnérables

- Cet appareil peut être utilisé par des enfants âgés d'au moins 8 ans et par des personnes ayant des capacités physiques, sensorielles ou mentales réduites ou dénuées d'expérience ou de connaissance, s'ils sont correctement surveillés ou si des instructions relatives à l'utilisation de l'appareil en toute sécurité leur ont été données et s'ils comprennent les risques encourus. Les enfants de moins de 8 ans et les personnes ayant un handicap très important et complexe doivent être tenus à l'écart de l'appareil, à moins d'être surveillés en permanence.
- Ne laissez pas les enfants jouer avec l'appareil.
- Ne laissez pas les emballages à la portée des enfants et jetez-les convenablement.
- **AVERTISSEMENT** : Tenez les enfants et les animaux éloignés de l'appareil lorsqu'il est en cours de fonctionnement ou lorsqu'il refroidit. Les parties accessibles deviennent chaudes en cours d'utilisation.
- Si l'appareil est équipé d'un dispositif de sécurité enfants, nous vous recommandons de l'activer.
- Le nettoyage et l'entretien ne doivent pas être effectués par des enfants sans surveillance.

### 1.2 Consignes générales de sécurité

- L'appareil doit être installé et le câble remplacé uniquement par un professionnel qualifié.

- **AVERTISSEMENT** : L'appareil et ses parties accessibles deviennent chauds pendant son fonctionnement. Veillez à ne pas toucher les éléments chauffants.
- Utilisez toujours des gants de cuisine pour retirer ou enfourner des accessoires ou des plats allant au four.
- Avant d'effectuer une opération de maintenance, débranchez l'appareil de la prise secteur.
- **AVERTISSEMENT** : Assurez-vous que l'appareil est éteint et débranché avant de remplacer l'éclairage afin d'éviter tout risque de choc électrique.
- N'utilisez pas l'appareil avant de l'avoir installé dans la structure encastrée.
- N'utilisez pas de nettoyeur vapeur pour nettoyer l'appareil.
- N'utilisez pas de produits abrasifs ni de racloirs pointus en métal pour nettoyer la porte en verre car ils peuvent rayer sa surface, ce qui peut briser le verre.
- Si le câble d'alimentation est endommagé, il doit être remplacé par le fabricant, un service de maintenance agréé ou un technicien qualifié afin d'éviter tout danger lié à l'électricité.
- Pour retirer les supports de grille, tirez d'abord sur l'avant de ceux-ci, puis sur l'arrière, pour les écarter des parois extérieures. Réinstallez les supports de grille en répétant cette procédure dans l'ordre inverse.

## 2. CONSIGNES DE SÉCURITÉ

### 2.1 Installation



#### **AVERTISSEMENT!**

L'appareil doit être installé uniquement par un professionnel qualifié.

- Retirez l'intégralité de l'emballage.
- N'installez pas et ne branchez pas un appareil endommagé.
- Suivez scrupuleusement les instructions d'installation fournies avec l'appareil.
- Soyez toujours vigilants lorsque vous déplacez l'appareil car il est lourd. Utilisez toujours des gants de sécurité et des chaussures fermées.
- Ne tirez jamais l'appareil par la poignée.
- Installez l'appareil dans un lieu sûr et adapté répondant aux exigences d'installation.
- Respectez l'espacement minimal requis par rapport aux autres appareils et éléments.
- Avant de monter l'appareil, vérifiez si la porte du four s'ouvre sans retenue.
- Cet appareil est équipé d'un système de refroidissement électrique. Il doit être utilisé lorsque l'appareil est raccordé à une prise secteur.

Hauteur minimale du meuble (Hauteur minimale du meuble sous le plan de travail)	590 (600) mm
Largeur du meuble	560 mm
Profondeur du meuble	550 (550) mm
Hauteur de l'avant de l'appareil	594 mm
Hauteur de l'arrière de l'appareil	576 mm
Largeur de l'avant de l'appareil	595 mm
Largeur de l'arrière de l'appareil	559 mm
Profondeur de l'appareil	569 mm
Profondeur d'encastrement de l'appareil	548 mm
Profondeur avec porte ouverte	1022 mm
Dimensions minimales de l'ouverture de ventilation. Ouverture placée sur la partie inférieure de la face arrière	560x20 mm
Longueur du câble d'alimentation secteur. Le câble est placé dans le coin droit de la face arrière	1500 mm
Vis de montage	4x25 mm

## 2.2 Raccordement électrique



### AVERTISSEMENT!

Risque d'incendie ou d'électrocution.

- Tous les raccordements électriques doivent être effectués par un électricien qualifié.
- L'appareil doit être relié à la terre.
- Assurez-vous que les paramètres figurant sur la plaque signalétique correspondent aux données électriques nominale de l'alimentation secteur.
- Utilisez toujours une prise de courant de sécurité correctement installée.
- N'utilisez pas d'adaptateurs multiprise et de rallonges.
- Veillez à ne pas endommager la fiche secteur ni le câble d'alimentation. Le remplacement du câble d'alimentation de

l'appareil doit être effectué par notre service après-vente agréé.

- Ne laissez pas les câbles d'alimentation entrer en contact ou s'approcher de la porte de l'appareil ou de la niche d'encastrement sous l'appareil, particulièrement lorsqu'il est en marche ou que la porte est chaude.
- La protection contre les chocs des parties sous tension et isolées doit être fixée de telle manière qu'elle ne puisse pas être enlevée sans outils.
- Ne branchez la fiche secteur dans la prise secteur qu'à la fin de l'installation. Assurez-vous que la prise secteur est accessible après l'installation.
- Si la prise secteur est détachée, ne branchez pas la fiche secteur.
- Ne tirez pas sur le câble secteur pour débrancher l'appareil. Tirez toujours sur la fiche de la prise secteur.
- N'utilisez que des systèmes d'isolation appropriés : des coupe-circuits, des fusibles (les fusibles à visser doivent être retirés du support), un disjoncteur différentiel et des contacteurs.
- L'installation électrique doit comporter un dispositif d'isolation qui vous permet de déconnecter l'appareil du secteur à tous les pôles. Le dispositif d'isolement doit avoir une largeur d'ouverture de contact de 3 mm minimum.
- Cet appareil est fourni avec une fiche d'alimentation et un câble d'alimentation.

### Types de câbles compatibles pour l'installation ou le remplacement pour l'Europe :

H07 RN-F, H05 RN-F, H05 RRF, H05 VV-F, H05 V2V2-F (T90), H05 BB-F

Pour la section du câble, consultez la puissance totale sur la plaque signalétique. Vous pouvez également consulter le tableau :

Puissance totale (W)	Section du câble (mm <sup>2</sup> )
maximum 1380	3 x 0.75
maximum 2300	3 x 1
maximum 3680	3 x 1.5



Le fil de masse (fil jaune/vert) doit faire 2 cm de plus que les fils de phase et neutre (fils bleu et marron).

### 2.3 Utilisation



#### **AVERTISSEMENT!**

Risque de blessures, de brûlures, d'électrocution ou d'explosion.

- Cet appareil est exclusivement destiné à une utilisation domestique.
- Ne modifiez pas les caractéristiques de cet appareil.
- Assurez-vous que les orifices de ventilation ne sont pas bouchés.
- Ne laissez jamais l'appareil sans surveillance pendant son fonctionnement.
- Éteignez l'appareil après chaque utilisation.
- Soyez prudent lors de l'ouverture de la porte de l'appareil lorsque celui-ci est en fonctionnement. De l'air brûlant peut s'en échapper.
- N'utilisez jamais cet appareil avec les mains mouillées ou lorsqu'il est en contact avec de l'eau.
- N'exercez jamais de pression sur la porte ouverte.
- N'utilisez jamais l'appareil comme plan de travail ou comme plan de stockage.
- Ouvrez prudemment la porte de l'appareil. Si vous utilisez des ingrédients contenant de l'alcool, un mélange d'alcool et d'air facilement inflammable peut éventuellement se former.
- Ne laissez pas des étincelles ou des flammes nues entrer en contact avec l'appareil lorsque vous ouvrez la porte.
- Ne placez pas de produits inflammables ou d'éléments imbibés de produits inflammables à l'intérieur ou à proximité de l'appareil, ni sur celui-ci.



#### **AVERTISSEMENT!**

Risque d'endommagement de l'appareil.

- Pour éviter tout endommagement ou décoloration de l'émail :
  - ne posez pas de plats allant au four ni aucun autre objet directement sur le fond de l'appareil.

- ne placez jamais de feuilles d'aluminium directement sur le fond de la cavité de l'appareil.
- ne versez jamais d'eau directement dans l'appareil lorsqu'il est chaud.
- une fois la cuisson terminée, ne laissez jamais d'aliments ou de plats humides à l'intérieur de l'appareil.
- faites attention lorsque vous retirez ou remettez en place les accessoires.
- La décoloration de l'émail ou de l'acier inoxydable est sans effet sur les performances de l'appareil.
- Utilisez un plat à rôtir pour obtenir des gâteaux moelleux. Les jus de fruits causent des taches qui peuvent être permanentes.
- Cet appareil est exclusivement destiné à un usage culinaire. Ne l'utilisez pas pour des usages autres que celui pour lequel il a été conçu, à des fins de chauffage par exemple.
- La porte du four doit toujours être fermée pendant la cuisson.
- Si l'appareil est installé derrière la paroi d'un meuble (par ex. une porte), veuillez à ce que la porte ne soit jamais fermée lorsque l'appareil fonctionne. La chaleur et l'humidité peuvent s'accumuler derrière la porte fermée du meuble et provoquer d'importants dégâts sur l'appareil, votre logement ou le sol. Ne fermez pas la paroi du meuble tant que l'appareil n'a pas refroidi complètement.

### 2.4 Entretien et Nettoyage



#### **AVERTISSEMENT!**

Risque de blessure, d'incendie ou de dommages matériels sur l'appareil.

- Avant toute opération d'entretien, éteignez l'appareil et débranchez la fiche de la prise secteur.
- Vérifiez que l'appareil est froid. Les panneaux de verre risquent de se briser.
- Remplacez immédiatement les vitres de la porte si elles sont endommagées. Contactez le service après-vente agréé.
- Soyez prudent lorsque vous retirez la porte de l'appareil. La porte est lourde !
- Nettoyez régulièrement l'appareil afin de maintenir le revêtement en bon état.

- Nettoyez l'appareil avec un chiffon doux humide. Utilisez uniquement des produits de lavage neutres. N'utilisez pas de produits abrasifs, de tampons à récurer, de solvants ni d'objets métalliques.
- Si vous utilisez un spray pour four, suivez les consignes de sécurité figurant sur son emballage.

## 2.5 Éclairage intérieur



**AVERTISSEMENT!**  
Risque d'électrocution !

- Concernant la/les lampe(s) à l'intérieur de ce produit et les lampes de rechange vendues séparément : Ces lampes sont conçues pour résister à des conditions physiques extrêmes dans les appareils électroménagers, telles que la température, les vibrations, l'humidité, ou sont conçues pour signaler des informations sur le statut opérationnel de l'appareil. Elles ne sont pas destinées à être utilisées dans d'autres applications et

ne conviennent pas à l'éclairage des pièces d'un logement.

- Utilisez uniquement des ampoules ayant les mêmes spécifications.

## 2.6 Maintenance

- Pour réparer l'appareil, contactez un service après-vente agréé.
- Utilisez exclusivement des pièces d'origine.

## 2.7 Mise au rebut



**AVERTISSEMENT!**  
Risque de blessure ou d'asphyxie.

- Débranchez l'appareil de l'alimentation électrique.
- Coupez le câble d'alimentation au ras de l'appareil et mettez-le au rebut.
- Retirez le dispositif de verrouillage du hublot pour empêcher les enfants et les animaux de s'enfermer dans l'appareil.

# 3. INSTALLATION



**AVERTISSEMENT!**  
Reportez-vous aux chapitres concernant la sécurité.

## 3.1 Encastrement



[www.youtube.com/electrolux](http://www.youtube.com/electrolux)  
[www.youtube.com/aeg](http://www.youtube.com/aeg)

How to install your AEG/Electrolux  
Oven - Column installation



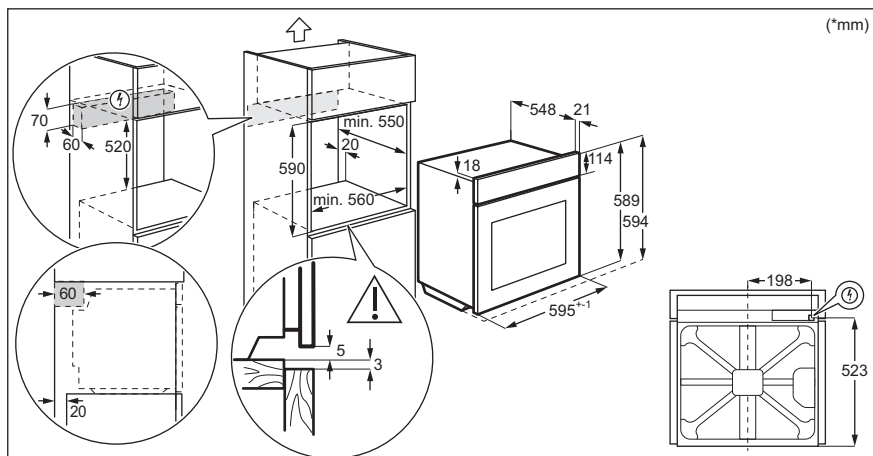
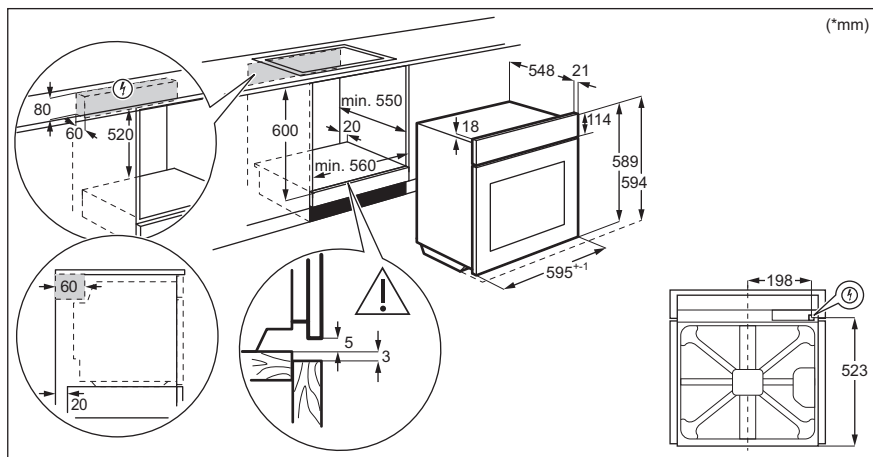

### 3.2 Fixation du four au meuble

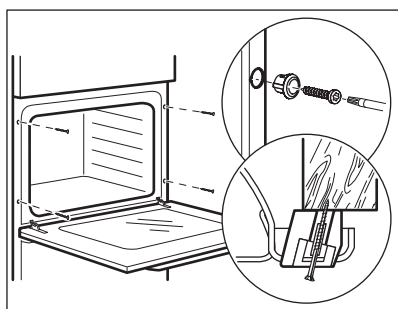

## 4. DESCRIPTION DE L'APPAREIL

### 4.1 Présentation générale

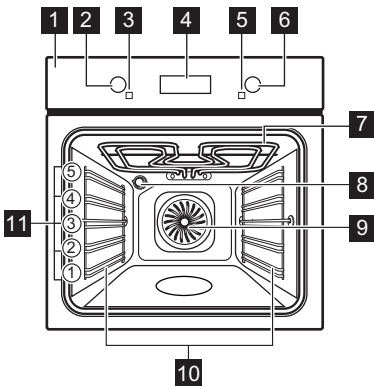

- 1 Bandeau de commande
- 2 Manette de sélection des modes de cuisson
- 3 Voyant / symbole de mise sous tension
- 4 Affichage
- 5 Indicateur / symbole de température
- 6 Thermostat
- 7 Élément chauffant
- 8 Éclairage
- 9 Ventilateur
- 10 Support de grille, amovible
- 11 Position des grilles

### 4.2 Accessoires

- **Grille métallique**  
Pour les plats à rôti, à gratin et les moules à gâteau/pâtisserie.
- **Plateau de cuisson**

- Pour les gâteaux et les biscuits.
- **Plat à rôtir/gril**  
Pour cuire et griller ou à utiliser comme plat pour recueillir la graisse.

## 5. BANDEAU DE COMMANDE

### 5.1 Manettes rétractables

Pour utiliser l'appareil, appuyez sur la manette. La manette sort alors de son logement.

### 5.2 Touches sensibles

—	Pour régler l'heure.
⌚	Pour régler une fonction de l'horloge.
+	Pour régler l'heure.

## 5.3 Affichage

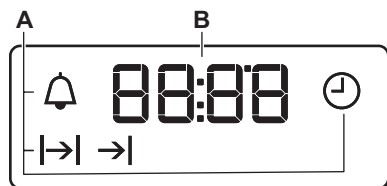

- A. Fonctions de l'horloge
- B. Minuteur

## 6. AVANT LA PREMIÈRE UTILISATION



### AVERTISSEMENT!

Reportez-vous aux chapitres concernant la sécurité.

### 6.1 Avant la première utilisation

Une odeur et de la fumée peuvent s'échapper du four durant le préchauffage. Assurez-vous que la pièce est ventilée.



Étape 1



Étape 2



Étape 3

Réglez l'horloge.	Nettoyez le four	Préchauffez le four à vide
1.  - appuyez pour régler l'heure. Après environ 5 s, le symbole cesse de clignoter et l'heure s'affiche.	1. Retirez les supports de grille amovibles et tous les accessoires du four. 2. Nettoyez le four et les accessoires avec un chiffon doux, de l'eau tiède et un détergent doux.	1. Réglez la température maximale pour la fonction : . Durée : 1 h. 2. Réglez la température maximale pour la fonction : . Durée : 15' 3. Réglez la température maximale pour la fonction : . Durée : 15'

Éteignez le four et attendez qu'il soit froid. Placez les accessoires et les supports de grille amovibles dans le four.

## 7. UTILISATION QUOTIDIENNE



### AVERTISSEMENT!

Reportez-vous aux chapitres concernant la sécurité.





### 7.1 Comment régler : Mode de cuisson





**Étape 1** Tournez la manette des modes de cuisson pour sélectionner un mode de cuisson.

**Étape 2** Tournez la manette pour sélectionner la température.

**Étape 3** Une fois la cuisson terminée, tournez les manettes sur la position Arrêt pour éteindre le four.

## 7.2 Modes de cuisson

Mode de cuisson	Application
<b>0</b> Position Arrêt	Le four est éteint.
 Eclairage four	Pour allumer l'éclairage.
 Chaleur tournante	Pour faire cuire sur 3 niveaux en même temps et pour déshydrater des aliments. Diminuez les températures du four de 20 à 40 °C par rapport à la Chauffage Haut/ Bas.
 Chaleur tournante humide	Cette fonction est conçue pour économiser de l'énergie en cours de cuisson. Lorsque vous utilisez cette fonction, la température à l'intérieur de la cavité peut différer de la température sélectionnée. La puissance peut être réduite. Pour plus d'informations, consultez le chapitre « Utilisation quotidienne », Remarques sur : Chaleur tournante humide.
 Cuisson de sole	Pour cuire des gâteaux à fond croustillant et pour stériliser des aliments.
 Gril	Pour faire griller des aliments peu épais et du pain.

Mode de cuisson	Application
 Gril rapide	Pour faire griller des aliments peu épais en grandes quantités et pour faire griller du pain.
 Turbo gril	Pour rôti de grosses pièces de viande ou de volaille avec os sur un seul niveau. Également pour gratiner et faire dorer.
 Fonction Pizza	Pour cuire des pizzas. Pour dorer de façon intensive et obtenir un fond croustillant.
 Chauffage Haut/ Bas	Pour cuire et rôti des aliments sur un seul niveau.

## 7.3 Remarques sur : Chaleur tournante humide

Cette fonction était utilisée pour se conformer à la classe d'efficacité énergétique et aux exigences d'éco-conception selon les normes EU 65/2014 et EU 66/2014. Tests conformément à la norme EN 60350-1.





Pendant la cuisson, la porte du four doit rester fermée pour éviter d'interrompre la fonction et pour un fonctionnement avec la meilleure efficacité énergétique possible.

Pour obtenir des instructions de cuisson, reportez-vous au chapitre « Conseils », paragraphe Chaleur tournante humide. Pour obtenir des recommandations générales sur les économies d'énergie, consultez le chapitre « Efficacité énergétique, « Four - Économie d'énergie ».

## 8. FONCTIONS DE L'HORLOGE

### 8.1 Fonctions de l'horloge

Fonction de l'horloge	Utilisation
 Heure	Pour régler, changer ou vérifier l'heure.

Fonction de l'horloge	Utilisation
 Durée	Pour régler la durée de fonctionnement du four.
 Fin	Pour régler l'heure d'arrêt du four.
 Départ différé	Pour combiner les fonctions : Durée et Fin.
 Minuteur	Pour régler la minuterie. Cette fonction est sans effet sur le fonctionnement du four. Vous pouvez régler cette fonction à tout moment, même quand le four est éteint.



## 8.2 Comment régler : Fonctions de l'horloge

### Comment régler : Heure

 - clignote lorsque vous branchez le four à l'alimentation électrique, lorsqu'il y a eu une coupure de courant ou que le minuteur n'est pas réglé.

 - appuyez pour régler l'heure.  
Après environ 5 s, le symbole cesse de clignoter et l'heure s'affiche.



### Comment modifier : Heure



**Étape 1**  - appuyez à plusieurs reprises pour modifier l'heure actuelle.  - commence à clignoter.

**Étape 2**  - appuyez pour régler l'heure.  
Après environ 5 s, le symbole cesse de clignoter et l'heure s'affiche.

### Comment régler : Durée

**Étape 1** Sélectionnez la fonction et la température du four.

**Étape 2**  - appuyez à plusieurs reprises.  - commence à clignoter.

**Étape 3**  - appuyez pour régler la durée.  
L'affichage indique :   
 - clignote lorsque la durée définie est écoulée. Le signal sonore retentit et le four s'éteint.

**Étape 4** Appuyez sur n'importe quelle touche pour arrêter le signal sonore.





**Étape 5** Tournez la manette sur la position Arrêt.

### Comment régler : Fin









**Étape 1** Sélectionnez la fonction et la température du four.

**Étape 2**  - appuyez à plusieurs reprises.  - commence à clignoter.





### Comment régler : Fin

- Étape 3**  ,  - appuyez pour régler l'heure.  
L'affichage indique :  |.  
 | - clignote lorsque la durée définie est écoulée. Le signal sonore retentit et le four s'éteint.
- Étape 4** Appuyez sur n'importe quelle touche pour arrêter le signal sonore.
- Étape 5** Tournez la manette sur la position Arrêt.



### Comment régler : Départ différé

- Étape 1** Sélectionnez la fonction et la température du four.
- Étape 2**  - appuyez à plusieurs reprises.  | - commence à clignoter.
- Étape 3**  ,  - appuyez pour régler la durée pour : Durée.
- Étape 4** Appuyez sur : .
- Étape 5**  ,  - appuyez pour régler la durée pour : Fin.
- Étape 6** Appuyez sur .  
Au bout de la durée définie, le signal sonore retentit et le four s'éteint.
- Étape 7** Appuyez sur n'importe quelle touche pour arrêter le signal sonore.
- Étape 8** Tournez la manette sur la position Arrêt.

### Comment régler : Minuteur

- Étape 1**  - appuyez à plusieurs reprises.  - commence à clignoter.
- Étape 2**  ,  - appuyez pour régler l'heure.  
La fonction démarre automatiquement au bout de 5 s.  
Lorsque la durée définie s'est écoulée, un signal sonore retentit.
- Étape 3** Appuyez sur n'importe quelle touche pour arrêter le signal sonore.
- Étape 4** Tournez la manette sur la position Arrêt.

### Comment annuler : Fonctions de l'horloge

- Étape 1**  - appuyez plusieurs fois jusqu'à ce que le symbole de la fonction horloge se mette à clignoter.
- Étape 2** Maintenez la touche .  
La fonction horloge est désactivée au bout de quelques secondes.

## 9. UTILISATION DES ACCESSOIRES



### AVERTISSEMENT!

Reportez-vous aux chapitres concernant la sécurité.

### 9.1 Insertion des accessoires

Une petite indentation sur le dessus apporte plus de sécurité. Les indentations sont également des dispositifs anti-bascule. Le



rebord élevé de la grille empêche les ustensiles de cuisine de glisser.

**Grille métallique:**

Poussez la grille entre les barres de guidage des supports de grille et assurez-vous que les pieds sont orientés vers le bas.

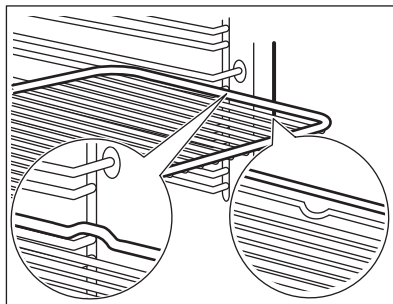

**Plateau de cuisson /Lèche-frite:**

Poussez le plateau entre les rails du support de grille.

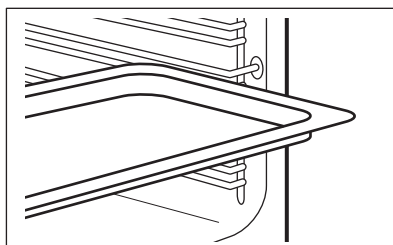

**Grille métallique, Plateau de cuisson /Lèche-frite:**

Poussez le plateau entre les rails du support de grille et glissez la grille métallique entre les rails se trouvant juste au-dessus.

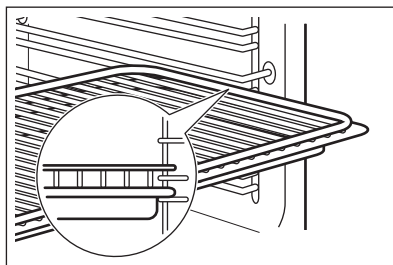

## 10. FONCTIONS SUPPLÉMENTAIRES

### 10.1 Ventilateur de refroidissement

Lorsque le four fonctionne, le ventilateur de refroidissement se met automatiquement en marche pour refroidir les surfaces du four. Si vous éteignez le four, le ventilateur de refroidissement continue à fonctionner jusqu'à ce que le four refroidisse.

### 10.2 Thermostat de sécurité

Un mauvais fonctionnement du four ou des composants défectueux peuvent causer une

surchauffe dangereuse. Pour éviter cela, le four dispose d'un thermostat de sécurité interrompant l'alimentation électrique. Le four se remet automatiquement en fonctionnement lorsque la température baisse.

## 11. CONSEILS ET ASTUCES



Reportez-vous aux chapitres concernant la sécurité.

### 11.1 Conseils de cuisson

Le four dispose de cinq niveaux de grille.

Comptez les niveaux de grille à partir du bas du four.

Votre four peut cuire les aliments d'une manière complètement différente de celle de votre ancien four. Les tableaux ci-dessous vous indiquent les réglages standard pour la température, le temps de cuisson et le niveau du four.

Si vous ne trouvez pas les réglages appropriés pour une recette spécifique, cherchez-en une qui s'en rapproche.

Le four est doté d'un système spécial qui permet à l'air de circuler et qui recycle perpétuellement la vapeur. Dans cet environnement, ce système permet de cuisiner des plats tout en maintenant ceux-ci tendres à l'intérieur et croquants à l'extérieur. Le temps de cuisson et la consommation énergétique sont donc réduits.

#### Cuisson de gâteaux

N'ouvrez la porte du four qu'aux 3/4 du temps de cuisson défini.

### 11.2 Rôtissage et cuisson

Si vous utilisez deux plaques de cuisson en même temps, laissez un niveau libre entre les deux.

#### Cuisson de viande et de poisson

Pour les aliments très gras, utilisez un plat à rôtir pour éviter de salir le four de manière irréversible.

Avant de couper la viande, laissez-la reposer pendant environ 15 minutes afin d'éviter que le jus ne s'écoule.







Pour éviter qu'une trop grande quantité de fumée ne se forme dans le four, ajoutez de l'eau dans le plat à rôtir. Pour éviter que la fumée ne se condense, ajoutez à nouveau de l'eau dans le plat à rôtir à chaque fois qu'il n'en contient plus.

#### Temps de cuisson







Le temps de cuisson varie selon le type d'aliment, sa consistance et son volume.

Au départ, surveillez la cuisson lorsque vous cuisinez. Ainsi, vous trouverez les meilleurs réglages (fonction, temps de cuisson, etc.) pour vos ustensiles, vos recettes et les quantités lorsque vous utiliserez l'appareil.

TEAUX GÂ-	Chauffage Haut/ Bas		Chaleur tournante		(min)	
	(°C)		(°C)			
Recettes avec un fouet	170	2	160	3 (2 et 4)	45 - 60	Moule à gâteau
Pâte sablée	170	2	160	3 (2 et 4)	20 - 30	Moule à gâteau
Cheesecake au babeurre	170	1	165	2	60 - 80	Moule à gâteau, Ø 26 cm
Strudel	175	3	150	2	60 - 80	Plateau de cuisson







 <b>TEAUX</b>	<b>Chauffage Haut/ Bas</b>		<b>Chaleur tournante</b>		 <b>(min)</b>	
	 (°C)		 (°C)			
Tarte à la confiture	170	2	165	2	30 - 40	Moule à gâteau, Ø 26 cm
Gâteau de Noël, préchauffer le four à vide	160	2	150	2	90 - 120	Moule à gâteau, Ø 20 cm
Gâteau aux prunes, préchauffer le four à vide	175	1	160	2	50 - 60	Moule à pain
Muffins	170	3	140 - 150	3	20 - 30	Plateau de cuisson
Muffins, deux niveaux	-	-	140 - 150	2 et 4	25 - 35	Plateau de cuisson
Muffins, trois niveaux	-	-	140 - 150	1, 3 et 5	30 - 45	Plateau de cuisson
Biscuits	140	3	140 - 150	3	30 - 35	Plateau de cuisson
Biscuits, deux niveaux	-	-	140 - 150	2 et 4	35 - 40	Plateau de cuisson
Biscuits, trois niveaux	-	-	140 - 150	1, 3 et 5	35 - 45	Plateau de cuisson
Meringues	120	3	120	3	80 - 100	Plateau de cuisson
Meringues, deux niveaux, préchauffer le four à vide	-	-	120	2 et 4	80 - 100	Plateau de cuisson
Petits pains, préchauffer le four à vide	190	3	190	3	12 - 20	Plateau de cuisson
Éclairs	190	3	170	3	25 - 35	Plateau de cuisson
Éclairs, deux niveaux	-	-	170	2 et 4	35 - 45	Plateau de cuisson
Tartes sur plateau	180	2	170	2	45 - 70	Moule à gâteau, Ø 20 cm
Gâteau avec beaucoup de fruits	160	1	150	2	110 - 120	Moule à gâteau, Ø 24 cm

Préchauffez le four à vide.

 <b>PAIN ET PIZZA</b>	<b>Chauffage Haut/ Bas</b>		<b>Chaleur tournante</b>		 (min)	
	 (°C)		 (°C)			
Pain blanc, 1 à 2 pièces, 0,5 kg chacune	190	1	190	1	60 - 70	-
Pain de seigle, le préchauffage n'est pas nécessaire	190	1	180	1	30 - 45	Moule à pain
Petits pains, 6 - 8 petits pains	190	2	180	2 (2 et 4)	25 - 40	Plateau de cuisson
Pizza	230 - 250	1	230 - 250	1	10 - 20	Plaque émaillée
Scones	200	3	190	3	10 - 20	Plateau de cuisson





Préchauffez le four à vide.





Utilisez le moule à gâteaux.







 <b>PRÉPARATIONS À BASE D'ŒUFS</b>	<b>Chauffage Haut/ Bas</b>		<b>Chaleur tournante</b>		 (min)
	 (°C)		 (°C)		
Flan de pâtes, le préchauffage n'est pas nécessaire	200	2	180	2	40 - 50
Flan de légumes, le préchauffage n'est pas nécessaire	200	2	175	2	45 - 60
Quiches	180	1	180	1	50 - 60
Lasagne	180 - 190	2	180 - 190	2	25 - 40
Cannellonis	180 - 190	2	180 - 190	2	25 - 40

Utilisez le deuxième niveau de la grille.





Utilisez la grille métallique.

 <b>VIANDE</b>	<b>Chauffage Haut/ Bas</b>		<b>Chaleur tournante</b>	 (min)
	 (°C)	 (°C)		
Bœuf	200	190		50 - 70
Porc	180	180		90 - 120
Veau	190	175		90 - 120

 <b>VIANDE</b>	Chauffage Haut/ Bas		Chaleur tournante	
	 (°C)	 (°C)	 (min)	
Rôti de bœuf, saignant	210	200	50 - 60	
Rôti de bœuf, cuit à point	210	200	60 - 70	
Rôti de bœuf, bien cuit	210	200	70 - 75	

 <b>VIANDE</b>	Chauffage Haut/ Bas		Chaleur tournante		
	 (°C)		 (°C)		 (min)
Palette de porc, avec couenne	180	2	170	2	120 - 150
Jarret de porc, 2 morceaux	180	2	160	2	100 - 120
Gigot d'agneau	190	2	175	2	110 - 130
Poulet entier	220	2	200	2	70 - 85
Dinde entière	180	2	160	2	210 - 240
Canard entier	175	2	220	2	120 - 150
Oie entière	175	2	160	1	150 - 200
Lapin, en morceaux	190	2	175	2	60 - 80
Lièvre, en morceaux	190	2	175	2	150 - 200
Faisan entier	190	2	175	2	90 - 120

Utilisez le deuxième niveau de la grille.

 <b>POISSON</b>	Chauffage Haut/ Bas		Chaleur tournante	
	 (°C)	 (°C)	 (min)	
Truite / Dorade, 3 - 4 poissons	190	175	40 - 55	
Thon / Saumon, 4 - 6 filets	190	175	35 - 60	

### 11.3 Gril

Préchauffez le four à vide.

Utilisez le quatrième niveau de la grille.

Réglez le gril à la température maximale.



(kg)

(min)  
1ère face

(min)  
2e face

Filets de bœuf, tranches, 4 morceaux	0,8	12 - 15	12 - 14
Steak de bœuf, 4 morceaux	0,6	10 - 12	6 - 8
Saucisses, 8	-	12 - 15	10 - 12
Côtelettes de porc, 4 morceaux	0,6	12 - 16	12 - 14
Poulet, demi, 2	1	30 - 35	25 - 30
Brochettes, 4	-	10 - 15	10 - 12
Blanc de poulet, 4 morceaux	0,4	12 - 15	12 - 14
Hamburgers, 6	0,6	20 - 30	-
Filet de poisson, 4 morceaux	0,4	12 - 14	10 - 12
Sandwiches toastés, 4 - 6	-	5 - 7	-
Toasts, 4 - 6	-	2 - 4	2 - 3

## 11.4 Turbo grill

Préchauffez le four à vide.

Utilisez le premier ou le deuxième niveau de la grille.

Pour calculer le temps de rôtissage, multipliez le temps indiqué dans le tableau ci-dessous par l'épaisseur de la viande en cm.



BŒUF



(°C)



(min)

Rôti ou filet de bœuf, saignant	190 - 200	5 - 6
Rôti ou filet de bœuf, à point	180 - 190	6 - 8
Rôti ou filet de bœuf, bien cuit	170 - 180	8 - 10



PORC



(°C)



(min)

Épaule / Cou / Noix de jambon, 1 - 1,5 kg	160 - 180	90 - 120
Côtelettes / Côte levée, 1 - 1,5 kg	170 - 180	60 - 90



PORC



(°C)



(min)

Pain de viande, 0,75 - 1 kg	160 - 170	50 - 60
Jarret de porc, pré-cuit, 0,75 - 1 kg	150 - 170	90 - 120



VEAU



(°C)



(min)

Rôti de veau, 1 kg	160 - 180	90 - 120
Jarret de veau, 1,5 - 2 kg	160 - 180	120 - 150



AGNEAU









(°C)



(min)

Gigot d'agneau / Rôti d'agneau, 1 - 1,5 kg	150 - 170	100 - 120
Selle d'agneau, 1 - 1,5 kg	160 - 180	40 - 60

 VOLAILLE	 (°C)	 (min)
Volaille, portions 0,2 - 0,25 kg chacune	200 - 220	30 - 50
Poulet, demi 0,4 - 0,5 kg chacune	190 - 210	35 - 50
Poulet, poularde, 1 - 1,5 kg	190 - 210	50 - 70
Canard, 1,5 - 2 kg	180 - 200	80 - 100
Oie, 3,5 - 5 kg	160 - 180	120 - 180
Dinde, 2,5 - 3,5 kg	160 - 180	120 - 150
Dinde, 4 - 6 kg	140 - 160	150 - 240

 POISSON (À LA VAPEUR)	 (°C)	 (min)
Poisson entier, 1 - 1,5 kg	210 - 220	40 - 60

### 11.5 Déshydratation - Chaleur tournante



Couvrez les plateaux avec du papier sulfurisé ou du papier de cuisson.

Pour de meilleurs résultats, arrêtez le four à mi-cuisson, ouvrez la porte et laissez-la



refroidir pendant une nuit pour terminer le séchage.

Pour un plateau, utilisez le troisième niveau de la grille.

Pour deux plateaux, utilisez les premier et quatrième niveaux de la grille.

 LÉGUMES	 (°C)	 (h)
Haricots	60 - 70	6 - 8
Poivrons	60 - 70	5 à 6
Légumes pour soupe	60 - 70	5 à 6
Champignons	50 - 60	6 - 8
Herbes	40 - 50	2 à 3

Réglez la température sur 60 - 70 °C.

 FRUITS	 (h)
Prunes	8 à 10
Abricots	8 à 10
Tranches de pommes	6 - 8
Poires	6 à 9

### 11.6 Chaleur tournante humide - accessoires recommandés

Utilisez les moules et récipients foncés et non réfléchissants. Ils offrent une meilleure absorption de la chaleur que les plats réfléchissants de couleur claire.



Plaque à pizza

Sombre, non réfléchissant  
Diamètre de 28 cm

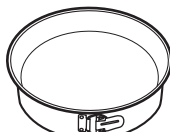

Plat de cuisson

Sombre, non réfléchissant  
Diamètre de 26 cm



Ramequins

Céramique  
8 cm de diamètre,  
5 cm de hauteur







Moule pour fond de tarte





Sombre, non réfléchissant  
Diamètre de 28 cm

### 11.7 Chaleur tournante humide

Pour de meilleurs résultats, suivez les suggestions indiquées dans le tableau ci-dessous.







		 (°C)		 (min)
Petits pains sucrés, (12 pièces)	Plateau de cuisson ou plat à rôtir	175	3	40 - 50
Petits pains, (9 pièces)	Plateau de cuisson ou plat à rôtir	180	2	35 - 45
Pizza, surgelée, 0,35 kg	grille métallique	180	2	45 - 55
Gâteau roulé	Plateau de cuisson ou plat à rôtir	170	2	30 - 40
Brownie	Plateau de cuisson ou plat à rôtir	170	2	45 - 50
Soufflé, (6 pièces)	ramequins en céramique sur une grille métallique	190	3	45 - 55
Fond de tarte en génoise	moule à tarte sur une grille métallique	180	2	35 - 45
Génoise Victoria	Plat de cuisson sur la grille métallique	170	2	35 - 50
Poisson poché, 0,3 kg	Plateau de cuisson ou plat à rôtir	180	2	35 - 45
Poisson entier, 0,2 kg	Plateau de cuisson ou plat à rôtir	180	3	25 - 35
Filet de poisson, 0,3 kg	plaque à pizza sur la grille métallique	170	3	30 - 40
Viande pochée, 0,25 kg	Plateau de cuisson ou plat à rôtir	180	3	35 - 45
Chachlyk, 0.5 kg	Plateau de cuisson ou plat à rôtir	180	3	40 - 50
Cookies, (16 pièces)	Plateau de cuisson ou plat à rôtir	150	2	30 - 45
Macarons, (20 pièces)	Plateau de cuisson ou plat à rôtir	180	2	45 - 55
Muffins, (12 pièces)	Plateau de cuisson ou plat à rôtir	170	2	30 - 40
Pâtisserie salée, (16 pièces)	Plateau de cuisson ou plat à rôtir	170	2	35 - 45
Biscuits à pâte brisée, (20 pièces)	Plateau de cuisson ou plat à rôtir	150	2	40 - 50
Tartelettes, (8 pièces)	Plateau de cuisson ou plat à rôtir	170	2	30 - 40
Légumes, pochés, 0.4 kg	Plateau de cuisson ou plat à rôtir	180	2	35 - 45
Omelette végétarienne	plaque à pizza sur la grille métallique	180	3	35 - 45









		 (°C)		 (min)
Légumes méditerranéens, 0.7 kg	Plateau de cuisson ou plat à rôtir	180	4	35 - 45

## 11.8 Informations pour les instituts de test

Tests conformément à la norme IEC 60350-1.

				 (°C)	 (min)	
Petits gâteaux, 20 par plateau	Chauffage Haut/ Bas	Plateau de cuisson	3	170	20 - 30	-
Petits gâteaux, 20 par plateau	Chaleur tournante	Plateau de cuisson	3	150 - 160	20 - 35	-
Petits gâteaux, 20 par plateau	Chaleur tournante	Plateau de cuisson	2 et 4	150 - 160	20 - 35	-
Tourte aux pommes, 2 moules Ø20 cm	Chauffage Haut/ Bas	Grille métallique	2	180	70 - 90	-
Tourte aux pommes, 2 moules Ø20 cm	Chaleur tournante	Grille métallique	2	160	70 - 90	-
Génoise, moule à gâteau de 26 cm	Chauffage Haut/ Bas	Grille métallique	2	170	40 - 50	Préchauffez le four pendant 10 minutes.
Génoise, moule à gâteau de 26 cm	Chaleur tournante	Grille métallique	2	160	40 - 50	Préchauffez le four pendant 10 minutes.
Génoise, moule à gâteau de 26 cm	Chaleur tournante	Grille métallique	2 et 4	160	40 - 60	Préchauffez le four pendant 10 minutes.
Sablé	Chaleur tournante	Plateau de cuisson	3	140 - 150	20 - 40	-
Sablé	Chaleur tournante	Plateau de cuisson	2 et 4	140 - 150	25 - 45	-

						
				(°C)	(min)	
Sablé	Chauffage Haut/ Bas	Plateau de cuisson	3	140 - 150	25 - 45	-
Toasts, 4 - 6 morceaux	Gril	Grille métallique	4	max.	2 à 3 minutes sur la première face ; 2 à 3 minutes sur la seconde face.	Préchauffez le four pendant 3 minutes.
Steak haché, 6 pièces, 0,6 kg	Gril	Grille métallique et lèche-frîte	4	max.	20 - 30	Placez la grille métallique sur le quatrième niveau et la lèche-frîte sur le troisième niveau du four. Tournez les aliments à mi-cuisson. Préchauffez le four pendant 3 minutes.

## 12. ENTRETIEN ET NETTOYAGE



### AVERTISSEMENT!

Reportez-vous aux chapitres concernant la sécurité.

### 12.1 Remarques concernant l'entretien



#### Agents nettoyants

Nettoyez la façade du four avec un chiffon doux, de l'eau tiède et un détergent doux. Nettoyez et contrôlez le joint de la porte autour du cadre de la cavité.

Utilisez une solution de nettoyage pour nettoyer les surfaces métalliques.

Nettoyez les taches avec un détergent doux.



#### Utilisation quotidienne

Nettoyez la cavité après chaque utilisation. L'accumulation de graisse ou d'autres résidus peut provoquer un incendie.

De l'humidité peut se déposer dans l'enceinte du four ou sur les vitres de la porte. Pour diminuer la condensation, laissez fonctionner le four pendant 10 minutes avant la cuisson. Ne conservez pas les aliments dans le four pendant plus de 20 minutes. Sécher la cavité avec un chiffon doux après chaque utilisation.



#### Accessoires

Après chaque utilisation, lavez tous les accessoires et séchez-les. Utilisez un chiffon doux avec de l'eau tiède et un détergent doux. Ne lavez pas les accessoires au lave-vaisselle.

Ne nettoyez pas les accessoires antiadhésifs avec un produit nettoyant abrasif ou des objets tranchants.

## 12.2 Comment enlever : Supports de grille

Retirez les supports de grille pour nettoyer le four.

**Étape 1** Éteignez le four et attendez qu'il soit froid.

**Étape 2** Écartez l'avant du support de grille de la paroi latérale.

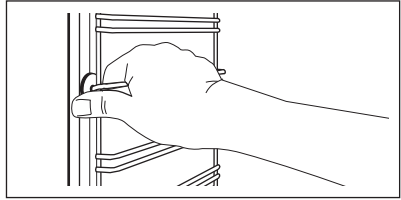

**Étape 3** Écartez l'arrière du support de grille de la paroi latérale et retirez le support.

**Étape 4** Réinstallez les supports de grille en répétant cette procédure dans l'ordre inverse.

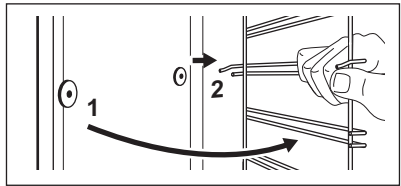

## 12.3 Comment démonter et installer : Porte

La porte du four est dotée de trois panneaux de verre. Vous pouvez retirer la porte du four ainsi que les panneaux de verre intérieurs afin de les nettoyer. Lisez toutes les instructions du chapitre « Retrait et installation de la porte » avant de retirer les panneaux de verre.



### ATTENTION!

N'utilisez pas le four sans les panneaux en verre.

**Étape 1** Ouvrez la porte en grand et identifiez la charnière située à droite de la porte.

**Étape 2** Servez-vous d'un tournevis pour soulever et faire pivoter le levier de la charnière droite.

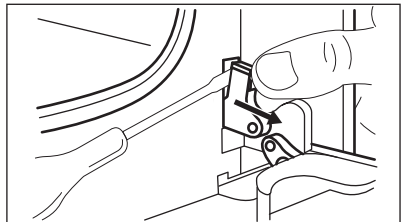

**Étape 3** Identifiez la charnière à gauche de la porte.

**Étape 4** Soulevez et faites complètement tourner le levier sur la charnière gauche.

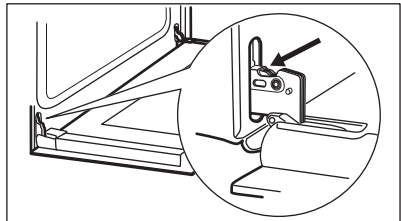

**Étape 5** Fermez la porte du four à la première position d'ouverture (mi-parcours). Puis soulevez et tirez la porte vers l'avant et retirez-la de son logement.

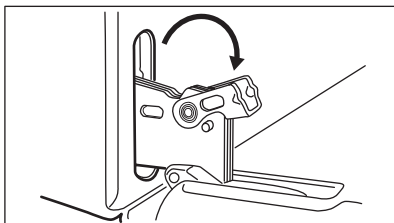

**Étape 6** Déposez la porte sur une surface stable recouverte d'un tissu doux.

**Étape 7** Tenez la garniture de porte (B) sur le bord supérieur de la porte des deux côtés et poussez vers l'intérieur pour libérer le joint du clip.

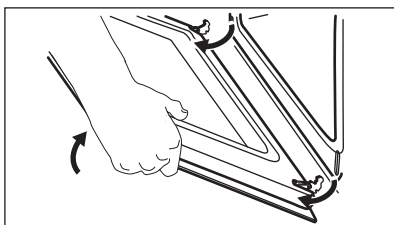

**Étape 8** Tirez la garniture de porte vers l'avant pour la déposer.

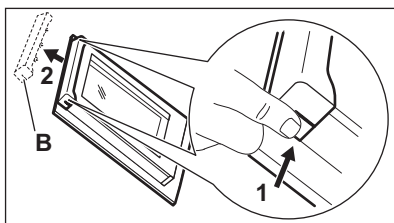

**Étape 9** Prenez les panneaux de verre de la porte par leur bord supérieur et tirez-les doucement, un par un. Commencez par le panneau supérieur. Assurez-vous que la vitre glisse entièrement hors de ses supports.

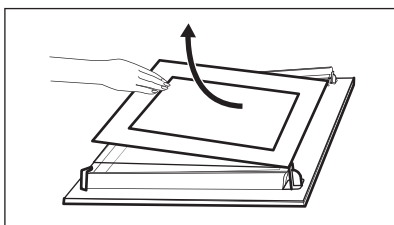

**Étape 10** Nettoyez les panneaux de verre avec de l'eau savonneuse. Séchez soigneusement les panneaux de verre. Ne nettoyez pas les panneaux de verre au lave-vaisselle.

**Étape 11** Après le nettoyage, installez les panneaux de verre et la porte du four.

Veillez à replacer les panneaux de verre (A et B) dans le bon ordre. Cherchez le symbole / l'impression se trouvant sur le côté du panneau de verre. Tous les panneaux ont un symbole différent pour faciliter le démontage et le montage.

Lorsque le cadre de la porte est installé correctement, il émet un clic.

Veillez à installer correctement le panneau de verre du milieu dans son logement.

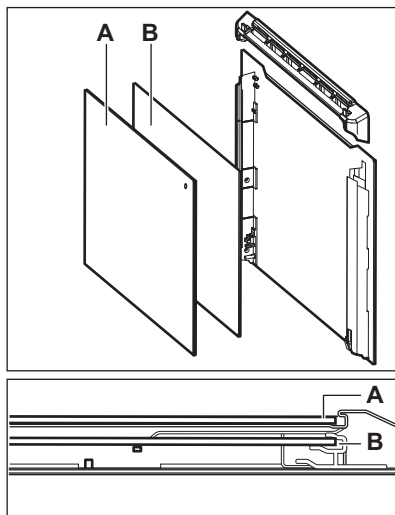

## 12.4 Comment remplacer : Éclairage



### AVERTISSEMENT!

Risque d'électrocution.

L'éclairage peut être chaud.

Tenez toujours l'ampoule halogène avec un chiffon afin d'éviter que des résidus de graisse ne brûlent sur l'ampoule.

### Avant de remplacer l'éclairage :

Étape 1	Étape 2	Étape 3
Éteignez le four. Attendez que le four ait refroidi.	Débranchez le four de l'alimentation secteur.	Placez un chiffon au fond de la cavité.

## Lampe arrière

**Étape 1** Tournez le diffuseur en verre pour le retirer.

**Étape 2** Nettoyez le diffuseur en verre.

**Étape 3** Remplacez l'éclairage par une ampoule adaptée résistant à une température de 300 °C.

**Étape 4** Remettez en place le diffuseur en verre.

## 13. DÉPANNAGE



### AVERTISSEMENT!

Reportez-vous aux chapitres concernant la sécurité.

### 13.1 Que faire si...

Dans tous les cas ne figurant pas dans ce tableau, veuillez contacter un service après-vente agréé.

Problème	Vérifiez si...
Le four ne chauffe pas.	Le fusible a disjoncté.
Le joint de la porte est endommagé.	N'utilisez pas le four. Contactez un service après-vente agréé.
L'affichage indique « 12.00 ».	Une coupure de courant s'est produite. Pour régler l'heure.
L'éclairage ne fonctionne pas.	L'ampoule est grillée.

## 13.2 Données de maintenance

Si vous ne trouvez pas de solution au problème, veuillez contacter votre revendeur ou un service après-vente agréé.

Les informations à fournir au service après-vente figurent sur la plaque signalétique. La plaque signalétique se trouve sur l'encadrement avant de la cavité du four. Ne retirez pas la plaque signalétique de la cavité du four.

### Nous vous recommandons de noter ces informations ici :

Modèle (MOD.) .....

Référence du produit (PNC) .....

Numéro de série (S.N.) .....

## 14. RENDEMENT ÉNERGÉTIQUE

### 14.1 Informations produit et Fiche d'informations produit\*

Nom du fournisseur	AEG
Identification du modèle	BEE431011M 949496317
Index d'efficacité énergétique	95.3
Classe d'efficacité énergétique	A
Consommation d'énergie avec charge standard et mode traditionnel	0.93 kWh/cycle
Consommation d'énergie avec charge standard et mode air pulsé	0.81 kWh/cycle
Nombre de cavités	1
Source de chaleur	Électricité
Volume	72 l
Type de four	Four encastrable
Masse	30.2 kg

\* Pour l'Union européenne conformément aux Règlements UE 65/2014 et 66/2014.  
 Pour la République de Biélorussie conformément à STB 2478-2017, Annexe G ; STB 2477-2017, Annexes A et B.  
 Pour l'Ukraine conformément à 568/32020.

La classe d'efficacité énergétique n'est pas applicable pour la Russie.

EN 60350-1 - Appareils de cuisson domestiques électriques - Partie 1 : Plages, fours, fours à vapeur et grils - Méthodes de mesure des performances.

## 14.2 Économie d'énergie



Ce four est doté de caractéristiques qui vous permettent d'économiser de l'énergie lors de votre cuisine au quotidien.

Veillez à ce que la porte du four soit fermée lorsqu'il fonctionne. N'ouvrez pas la porte du four trop souvent pendant la cuisson. Gardez le joint de porte propre et veillez à ce qu'il soit bien fixé en place.

Utilisez des plats en métal pour accroître les économies d'énergie.

Si possible, ne préchauffez pas le four avant la cuisson.

Lorsque vous cuisez plusieurs plats les uns après les autres, veillez à ne pas trop espacer les cuissons.

### **Cuisson avec ventilation**

Si possible, utilisez les fonctions de cuisson avec la ventilation pour économiser de l'énergie.

### **Chaleur résiduelle**

Si la cuisson doit durer plus de 30 minutes, réduisez la température du four au minimum 3 à 10 minutes avant la fin de la cuisson. La chaleur résiduelle à l'intérieur du four poursuivra la cuisson.

Utilisez la chaleur résiduelle pour réchauffer d'autres plats.

### **Maintien des aliments au chaud**

Sélectionnez la température la plus basse possible pour utiliser la chaleur résiduelle et maintenir le repas au chaud.

### **Chaleur tournante humide**

Fonction conçue pour économiser de l'énergie en cours de cuisson.

## 15. EN MATIÈRE DE PROTECTION DE L'ENVIRONNEMENT

Recyclez les matériaux portant le symbole . Déposez les emballages dans les conteneurs prévus à cet effet. Contribuez à la protection de l'environnement et à votre sécurité, recyclez vos produits électriques et électroniques. Ne jetez pas les appareils

portant le symbole  avec les ordures ménagères. Emmenez un tel produit dans votre centre local de recyclage ou contactez vos services municipaux.

## PER RISULTATI PERFETTI

Grazie per aver scelto di acquistare questo prodotto AEG. Lo abbiamo creato per fornirvi prestazioni impeccabili per molti anni, grazie a tecnologie innovative che vi semplificheranno la vita - funzioni che non troverete sulle normali apparecchiature. Vi invitiamo di dedicare qualche minuto alla lettura per sapere come trarre il massimo dal vostro elettrodomestico.

**Visitate il nostro sito web per:**



Ricevere consigli, scaricare i nostri opuscoli, eliminare eventuali anomalie, ottenere informazioni sull'assistenza e la riparazione:

**[www.aeg.com/support](http://www.aeg.com/support)**



Per registrare il vostro prodotto e ricevere un servizio migliore:

**[www.registeraeg.com](http://www.registeraeg.com)**



Acquistare accessori, materiali di consumo e ricambi originali per la vostra apparecchiatura:

**[www.aeg.com/shop](http://www.aeg.com/shop)**

## ASSISTENZA CLIENTI E ASSISTENZA TECNICA

Consigliamo sempre l'impiego di ricambi originali.

Quando si contatta il nostro Centro di Assistenza Autorizzato, accertarsi di avere a disposizione i dati seguenti: Modello, numero dell'apparecchio (PNC), numero di serie.

Le informazioni sono riportate sulla targhetta identificativa.

 Avvertenza/Attenzione - Importanti Informazioni per la sicurezza

 Informazioni generali e suggerimenti

 Informazioni ambientali

Con riserva di modifiche.

## INDICE

1. INFORMAZIONI DI SICUREZZA.....	81
2. ISTRUZIONI DI SICUREZZA.....	82
3. INSTALLAZIONE.....	85
4. DESCRIZIONE DEL PRODOTTO.....	87
5. PANNELLO DEI COMANDI.....	87
6. PRIMA DI UTILIZZARE L'ELETTRODOMESTICO.....	88
7. UTILIZZO QUOTIDIANO.....	88
8. FUNZIONI DEL TIMER.....	89
9. UTILIZZO DEGLI ACCESSORI.....	92
10. FUNZIONI AGGIUNTIVE.....	93
11. CONSIGLI E SUGGERIMENTI UTILI.....	93
12. PULIZIA E CURA.....	101
13. RISOLUZIONE DEI PROBLEMI.....	104
14. EFFICIENZA ENERGETICA.....	105



## 1. ⚠️ INFORMAZIONI DI SICUREZZA

Leggere attentamente le istruzioni fornite prima di installare e utilizzare l'apparecchiatura. I produttori non sono responsabili di eventuali lesioni o danni derivanti da un'installazione o un uso scorretti. Conservare sempre le istruzioni in un luogo sicuro e accessibile per poterle consultare in futuro.

### 1.1 Sicurezza di bambini e persone vulnerabili

- Questa apparecchiatura può essere usata da bambini a partire dagli 8 anni e da adulti con limitate capacità fisiche, sensoriali o mentali o con scarsa esperienza o conoscenza sull'uso dell'apparecchiatura, solamente se sorvegliati o se istruiti relativamente all'uso dell'apparecchiatura e se hanno compreso i rischi coinvolti. I bambini che hanno meno di 8 anni e le persone con disabilità diffuse e complesse vanno tenuti lontani dall'apparecchiatura a meno che non vi sia una supervisione continua.
- Non lasciare che i bambini giochino con l'apparecchiatura.
- Tenere gli imballaggi lontano dai bambini e smaltirli in modo adeguato.
- **AVVERTENZA:** Tenere i bambini e gli animali domestici lontano dall'apparecchiatura durante il funzionamento o raffreddamento. Alcune parti accessibili diventano calde durante l'uso.
- Se l'apparecchiatura ha un dispositivo di sicurezza per i bambini sarà opportuno attivarlo.
- I bambini non devono eseguire interventi di pulizia e manutenzione sull'apparecchiatura senza essere supervisionati.

### 1.2 Avvertenze di sicurezza generali

- L'installazione dell'apparecchiatura e la sostituzione dei cavi deve essere svolta unicamente da personale qualificato.
- **AVVERTENZA:** L'apparecchiatura e le parti accessibili si riscaldano molto durante l'uso. Abbiate cura di non toccare gli elementi riscaldanti.

- Servirsi sempre degli appositi guanti da forno per estrarre o inserire accessori o pentole resistenti al calore.
- Prima di qualsiasi intervento di manutenzione, scollegare l'apparecchiatura dalla presa di corrente.
- **AVVERTENZA:** Assicurarsi che l'apparecchiatura sia spenta prima di sostituire la lampadina per evitare la possibilità di scosse elettriche.
- Non usare l'apparecchiatura prima di installarla nella struttura a incasso.
- Non usare una pulitrice a vapore per pulire l'apparecchiatura.
- Non utilizzare detergenti abrasivi o raschietti di metallo per pulire il vetro della porta per non rigare la superficie e causare la rottura del vetro.
- Se il cavo di alimentazione è danneggiato, deve essere sostituito dal produttore, da un tecnico autorizzato o da una persona qualificata per evitare situazioni di pericolo.
- Per rimuovere i supporti ripiano, sfilare innanzitutto la parte anteriore del supporto, quindi quella posteriore, dalle pareti laterali. Installare i supporti griglia seguendo al contrario la procedura indicata.

## 2. ISTRUZIONI DI SICUREZZA

### 2.1 Installazione



#### **AVVERTENZA!**

L'installazione dell'apparecchiatura deve essere eseguita da personale qualificato.

- Rimuovere tutti i materiali di imballaggio.
- Non installare o utilizzare l'apparecchiatura se è danneggiata.
- Attenersi alle istruzioni fornite insieme all'apparecchiatura.
- Prestare sempre attenzione in fase di spostamento dell'apparecchiatura, dato che è pesante. Usare sempre i guanti di sicurezza e le calzature adeguate.
- Non tirare l'apparecchiatura per la maniglia.

- Installare l'apparecchiatura in un luogo sicuro e idoneo che soddisfi i requisiti di installazione.
- È necessario rispettare la distanza minima dalle altre apparecchiature.
- Prima di montare l'apparecchiatura controllare che la porta del forno si apra senza limitazioni.
- L'apparecchiatura è dotata di un sistema elettrico di raffreddamento. Questo deve essere alimentato elettricamente.

Altezza minima del mobiletto (mobiletto sotto all'altezza minima del piano di lavoro)	590 (600) mm
---	--------------

Larghezza del mobiletto	560 mm
-------------------------	--------

Profondità del mobiletto	550 (550) mm
--------------------------	--------------

Altezza della parte anteriore dell'apparecchiatura	594 mm
Altezza della parte posteriore dell'apparecchiatura	576 mm
Larghezza della parte anteriore dell'apparecchiatura	595 mm
Larghezza della parte posteriore dell'apparecchiatura	559 mm
Profondità dell'apparecchiatura	569 mm
Profondità di incasso dell'apparecchiatura	548 mm
Profondità con oblò aperto	1022 mm
Dimensioni minime dell'apertura di ventilazione. Apertura collocata sul lato posteriore inferiore	560x20 mm
Lunghezza del cavo di alimentazione. Il cavo è collocato nell'angolo destro del lato posteriore.	1500 mm
Viti di montaggio	4x25 mm

## 2.2 Collegamento elettrico



### AVVERTENZA!

Rischio di incendio e scossa elettrica.

- Tutti i collegamenti elettrici devono essere realizzati da un elettricista qualificato.
- L'apparecchiatura deve disporre di una messa a terra.
- Verificare che i parametri sulla targhetta siano compatibili con le indicazioni elettriche dell'alimentazione.
- Utilizzare sempre una presa elettrica con contatto di protezione correttamente installata.
- Non utilizzare prese multiple e prolunghe.
- Accertarsi di non danneggiare la spina e il cavo. Qualora il cavo elettrico debba essere sostituito, l'intervento dovrà essere effettuato dal nostro Centro di Assistenza autorizzato.
- Evitare che i cavi entrino a contatto o si trovino vicino alla porta dell'apparecchiatura o sulla nicchia sotto all'apparecchiatura, in particolare quando il dispositivo è in funzione o la porta è calda.

- I dispositivi di protezione da scosse elettriche devono essere fissati in modo tale da non poter essere disattivati senza l'uso di attrezzi.
- Inserire la spina di alimentazione nella presa solo al termine dell'installazione. Verificare che la spina di alimentazione rimanga accessibile dopo l'installazione.
- Nel caso in cui la spina di corrente sia allentata, non collegarla alla presa.
- Non tirare il cavo di alimentazione per scollegare l'apparecchiatura. Tirare sempre dalla spina.
- Servirsi unicamente di dispositivi di isolamento adeguati: interruttori automatici, fusibili (quelli a tappo devono essere rimossi dal portafusibile), sganciatori per correnti di guasto a terra e relè.
- L'impianto elettrico deve essere dotato di un dispositivo di isolamento che consenta di scollegare l'apparecchiatura dalla presa di corrente a tutti i poli. Il dispositivo di isolamento deve avere una larghezza dell'apertura di contatto non inferiore ai 3 mm.
- La dotazione standard dell'apparecchiatura al momento della fornitura prevede una spina e un cavo di rete.

### Tipi di cavi disponibili per l'installazione o la sostituzione per l'Europa:

H07 RN-F, H05 RN-F, H05 RRF, H05 VV-F, H05 V2V2-F (T90), H05 BB-F

Per la sezione del cavo, fare riferimento alla potenza totale riportata sulla targhetta dei dati. E' anche possibile consultare la tabella:

Potenza totale (W)	Sezione del cavo (mm <sup>2</sup> )
massimo 1380	3 x 0.75
massimo 2300	3 x 1
massimo 3680	3 x 1.5

Il cavo di terra (verde/giallo) deve essere 2 cm più lungo dei cavi di fase e neutro (rispettivamente blu e marrone).

## 2.3 Utilizzo:



### AVVERTENZA!

Rischio di lesioni, ustioni, scosse elettriche o esplosioni.

- Questa apparecchiatura è stata prevista unicamente per un uso domestico.
- Non modificare le specifiche tecniche dell'apparecchiatura.
- Accertarsi che le fessure di ventilazione non siano ostruite.
- Non lasciare mai l'apparecchiatura incustodita durante il funzionamento.
- Spegnerne l'apparecchiatura dopo ogni utilizzo.
- Prestare attenzione in fase di apertura della porta dell'apparecchiatura quando quest'ultima è in funzione. Può fuoriuscire aria calda.
- Non mettere in funzione l'apparecchiatura con le mani umide o quando c'è un contatto con l'acqua.
- Non esercitare pressione sulla porta aperta.
- Non utilizzare l'apparecchiatura come superficie di lavoro o come piano di appoggio.
- Aprire la porta dell'apparecchiatura con cautela. L'uso di ingredienti contenenti alcol può causare una miscela di alcol e aria.
- Evitare la presenza di scintille o fiamme aperte vicino all'apparecchiatura quando si apre la porta.
- Non appoggiare o tenere liquidi o materiali infiammabili, né oggetti facilmente incendiabili sull'apparecchiatura, al suo interno o nelle immediate vicinanze.



### AVVERTENZA!

Vi è il rischio di danneggiare l'apparecchiatura.

- Per evitare danni o lo scolorimento dello smalto:
  - Non mettere pentole resistenti al calore o altri oggetti direttamente sulla superficie inferiore dell'apparecchiatura.
  - Non appoggiare la pellicola di alluminio direttamente sulla parte bassa della cavità dell'apparecchiatura.

- Non mettere direttamente acqua all'interno dell'apparecchiatura calda.
- Non tenere piatti umidi e cibo all'interno dell'apparecchiatura dopo aver terminato la fase di cottura.
- Prestare attenzione quando si tolgono o inseriscono gli accessori.
- Lo scolorimento dello smalto o dell'acciaio inox non influisce sulle prestazioni dell'apparecchiatura.
- Per le torte molto umide, usare una leccarda. I succhi di frutta provocano macchie che possono essere permanenti.
- L'apparecchiatura è destinata solo alla cottura. Non deve essere utilizzata per altri scopi, come per esempio il riscaldamento di un ambiente.
- La cottura deve sempre essere eseguita con la porta del forno chiusa.
- Se l'apparecchiatura si trova dietro a un pannello anteriore (ad es. una porta), assicurarsi che questo non sia mai chiuso quando l'apparecchiatura è in funzione. Calore e umidità possono accumularsi sul retro di un pannello chiuso causando danni all'apparecchiatura, all'alloggiamento o al pavimento. Dopo l'uso non chiudere il pannello dell'armadio finché l'apparecchiatura non si è completamente raffreddata.

## 2.4 Pulizia e cura



### AVVERTENZA!

Vi è il rischio di lesioni, incendio o danni all'apparecchiatura.

- Prima di eseguire qualunque intervento di manutenzione, spegnere l'apparecchiatura ed estrarre la spina dalla presa.
- Controllare che l'apparecchiatura sia fredda. Vi è il rischio che i pannelli in vetro si rompano.
- Sostituire immediatamente i pannelli in vetro della porta nel caso in cui siano danneggiati. Contattare il Centro Assistenza Autorizzato.
- Prestare attenzione quando si rimuove la porta dall'apparecchio. La porta è pesante!
- Pulire regolarmente l'apparecchiatura per evitare il deterioramento dei materiali che compongono la superficie.

- Pulire l'apparecchiatura con un panno inumidito e morbido. Utilizzare solo detergenti neutri. Non usare prodotti abrasivi, spugnette abrasive, solventi od oggetti metallici.
- Se si utilizza uno spray per il forno, seguire attentamente le istruzioni di sicurezza sulla confezione.

## 2.5 Illuminazione interna



### AVVERTENZA!

Pericolo di scosse elettriche.

- Per quanto riguarda la lampada o le lampade all'interno di questo prodotto e le lampade di ricambio vendute separatamente: Queste lampade sono destinate a resistere a condizioni fisiche estreme negli elettrodomestici, come temperatura, vibrazioni, umidità, o sono destinate a segnalare informazioni sullo stato operativo dell'apparecchio. Non sono destinate ad essere utilizzate in altre applicazioni e non sono adatte per l'illuminazione di ambienti domestici.

- Servirsi unicamente di lampadine con le stesse specifiche tecniche .

## 2.6 Assistenza tecnica

- Per riparare l'apparecchiatura contattare un Centro di Assistenza Autorizzato.
- Utilizzare esclusivamente ricambi originali.

## 2.7 Smaltimento



### AVVERTENZA!

Rischio di lesioni o soffocamento.

- Staccare la spina dall'alimentazione elettrica.
- Tagliare il cavo elettrico dell'apparecchiatura e smaltirlo.
- Togliere il blocco porta per evitare che bambini o animali restino intrappolati nell'apparecchiatura.

# 3. INSTALLAZIONE



### AVVERTENZA!

Fare riferimento ai capitoli sulla sicurezza.

## 3.1 Incasso



[www.youtube.com/electrolux](http://www.youtube.com/electrolux)  
[www.youtube.com/aeg](http://www.youtube.com/aeg)

How to install your AEG/Electrolux  
Oven - Column installation



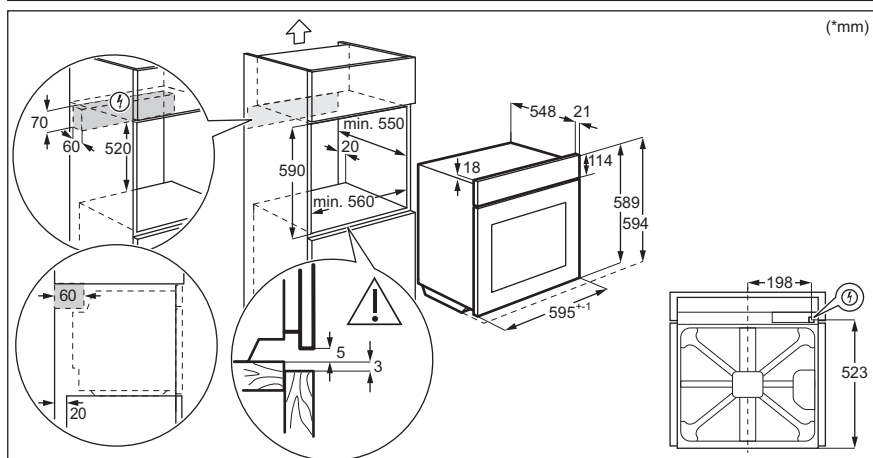
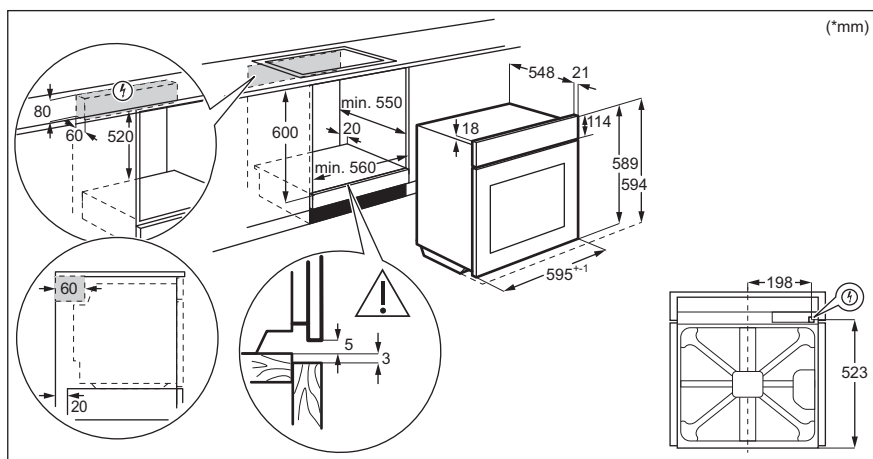

### 3.2 Fissaggio nel mobile

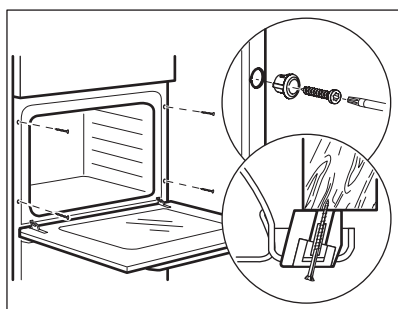

## 4. DESCRIZIONE DEL PRODOTTO

### 4.1 Panoramica

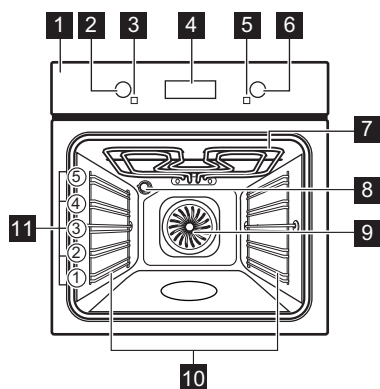

- 1 Pannello di controllo
- 2 Manopola di regolazione delle funzioni di riscaldamento
- 3 Lampadina/simbolo alimentazione
- 4 Display
- 5 Indicatore della temperatura / simbolo
- 6 Manopola di regolazione della temperatura
- 7 Resistenza
- 8 Lampadina
- 9 Ventilatore
- 10 Supporto ripiano, smontabile
- 11 Posizioni dei ripiani

### 4.2 Accessori

- **Griglia**  
Per pentole, stampi per dolci, arrosti.
- **Lamiera dolci**  
Per la cottura di torte e biscotti.

- **Leccarda**  
Per cuocere al forno, arrostito o come recipiente per raccogliere i grassi.

## 5. PANNELLO DEI COMANDI

### 5.1 Manopola incassabile

Per utilizzare l'apparecchiatura, premere la manopola. La manopola fuoriesce.

### 5.2 Campo sensore / Pulsante

—	Per impostare l'ora.
⊙	Per impostare una funzione orologio.
+	Per impostare l'ora.

## 5.3 Display

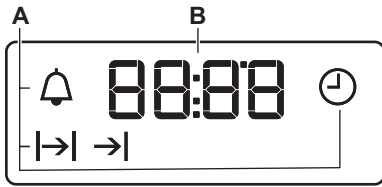

- A. Funzioni dell'orologio
- B. Timer

## 6. PRIMA DI UTILIZZARE L'ELETTRODOMESTICO



### AVVERTENZA!

Fare riferimento ai capitoli sulla sicurezza.

### 6.1 Prima di utilizzare l'apparecchiatura per la prima volta

Il forno può produrre un odore sgradevole e fumo in fase di preriscaldamento. Accertarsi che la stanza sia ventilata.





Fase 1



Fase 2



Fase 3

Imposta l'orologio	Pulire il forno	Preriscaldare il forno vuoto
<ol style="list-style-type: none"> <li>1. <b>+</b>, <b>-</b> - premere per impostare l'ora. Dopo 5 secondi circa, la spia smette di lampeggiare e l'orologio indica l'ora impostata.</li> </ol>	<ol style="list-style-type: none"> <li>1. Rimuovere gli accessori e i supporti ripiano rimovibili dal forno.</li> <li>2. Pulire il forno e gli accessori con un panno morbido imbevuto di acqua tiepida e detergente delicato.</li> </ol>	<ol style="list-style-type: none"> <li>1. Impostare la temperatura massima per la funzione: . Tempo: 1 ora</li> <li>2. Impostare la temperatura massima per la funzione: . Tempo: 15 min.</li> <li>3. Impostare la temperatura massima per la funzione: . Tempo: 15 min.</li> </ol>
<p>Spegnere il forno e attendere che si raffreddi. Collocare gli accessori e i supporti ripiano rimovibili nel forno.</p>		

## 7. UTILIZZO QUOTIDIANO



### AVVERTENZA!

Fare riferimento ai capitoli sulla sicurezza.







### 7.1 Come impostare: Funzione cottura

- |               |  |
|---------------|--|
| <b>Fase 1</b> | Ruotare la manopola delle funzioni di riscaldamento per selezionare una funzione di riscaldamento. |
| <b>Fase 2</b> | Ruotare la manopola di controllo per selezionare la temperatura.                                   |



**Fase 3** Al termine della cottura, ruotare le manopole fino alla posizione off per spegnere il forno.

## 7.2 Funzioni cottura

Funzione cottura	Applicazione
	Il forno è spento.
Posizione di spento	
	Per accendere la lampada.
Luce forno	
	Per cuocere su un massimo di tre ripiani contemporaneamente e per asciugare gli alimenti. Impostare la temperatura 20 - 40 °C inferiore a per Cottura convenzionale .
Cottura ventilata	
	Questa funzione è stata progettata per risparmiare energia durante la cottura. Quando si utilizza questa funzione, la temperatura nella cavità può differire dalla temperatura impostata. La potenza di riscaldamento può essere ridotta. Per ulteriori informazioni, fare riferimento al capitolo "Uso quotidiano", Note su: Cottura ventilata umida.
Cottura ventilata umida	
	Per cuocere torte dal fondo croccante e conservare gli alimenti.
Resistenza inferiore	
	Per grigliare pezzi sottili e tostare il pane.
Grill	

Funzione cottura	Applicazione
	Per grigliare in grandi quantità pezzi sottili di cibo e per tostare il pane.
Grill Rapido	
	Per tostare grandi pezzi di carne o pollame con le ossa in una posizione del ripiano. Per fare gratin e abbrustolire.
Turbo Grill	
	Per cuocere la pizza al forno. Per abbrustolire in modo intensivo ed avere un fondo croccante.
Funzione Pizza	
	Per cuocere e arrostitire alimenti su una sola posizione della griglia.
Cottura convenzionale	

## 7.3 Note su: Cottura ventilata umida

Questa funzione è stata usata per attenersi alla classe energetica e ai requisiti di ecodesign conformemente alla normativa EU 65/2014 e EU 66/2014. Test conformemente alla norma EN 60350-1.





La porta del forno dovrebbe essere chiusa in fase di cottura, di modo che la funzione non venga interrotta. Ciò garantisce inoltre che il forno funzioni con la più elevata efficienza energetica possibile.

Per istruzioni di cottura rimandiamo al capitolo "Consigli e suggerimenti", Cottura ventilata umida. Per indicazioni generali relativamente al risparmio energetico rimandiamo al capitolo "Efficienza energetica", Risparmio energetico.

## 8. FUNZIONI DEL TIMER

### 8.1 Funzioni dell'orologio

Funzione orologio	Applicazione
	Permette di modificare o controllare l'ora.
Imposta ora	

Funzione orologio	Applicazione
 Durata	Per impostare la durata di funzionamento del forno.
 Orario fine	Per impostare quando il forno si spegne.
 Ritardo di tempo	Per combinare funzioni: Durata e Orario fine.
 Contaminuti	Per impostare il conto alla rovescia. Questa funzione non ha effetto sull'uso del forno. È possibile impostare questa funzione in qualsiasi momento, anche quando il forno è spento.



## 8.2 Come impostare: Funzioni dell'orologio



### Come impostare: Imposta ora

 - lampeggia quando si collega il forno all'alimentazione elettrica, quando c'è stato un blackout o quando il timer non è impostato.

 ,  - premere per impostare l'ora.  
Dopo 5 secondi circa, la spia smette di lampeggiare e l'orologio indica l'ora impostata.

### Come modificare: Imposta ora





**Passaggio 1**  - premere ripetutamente per cambiare l'ora del giorno.  - inizia a lampeggiare.

**Passaggio 2**  ,  - premere per impostare l'ora.  
Dopo 5 secondi circa, la spia smette di lampeggiare e l'orologio indica l'ora impostata.

### Come impostare: Durata

**Passaggio 1** Selezionare una funzione del forno e regolare la temperatura.

**Passaggio 2**  - premere ripetutamente.  - inizia a lampeggiare.

**Passaggio 3**  ,  - premere per impostare la durata.  
Il display visualizza:   
 - lampeggia al termine del tempo impostato. Viene emesso un segnale acustico e il forno si spegne.

**Passaggio 4** Premere un tasto per interrompere il segnale.

**Passaggio 5** Portare la manopola nella posizione di spegnimento.

## Come impostare: Orario fine

**Passaggio 1** Selezionare una funzione del forno e regolare la temperatura.

**Passaggio 2**  - premere ripetutamente.  - inizia a lampeggiare.

**Passaggio 3**  ,  - premere per impostare l'ora.

Il display visualizza: .

 - lampeggia al termine del tempo impostato. Viene emesso un segnale acustico e il forno si spegne.

**Passaggio 4** Premere un tasto per interrompere il segnale.

**Passaggio 5** Portare la manopola nella posizione di spegnimento.



## Come impostare: Ritardo di tempo

**Passaggio 1** Selezionare una funzione del forno e regolare la temperatura.

**Passaggio 2**  - premere ripetutamente.  - inizia a lampeggiare.

**Passaggio 3**  ,  - premere per impostare l'ora per: Durata.

**Passaggio 4** Premere: .

**Passaggio 5**  ,  - premere per impostare l'ora per: Orario fine.



**Passaggio 6** Premere: .  
Al termine del tempo impostato viene emesso un segnale acustico e il forno si spegne.

**Passaggio 7** Premere un tasto per interrompere il segnale.

**Passaggio 8** Portare la manopola nella posizione di spegnimento.

## Come impostare: Contaminuti

**Passaggio 1**  - premere ripetutamente.  - inizia a lampeggiare.

**Passaggio 2**  ,  - premere per impostare l'ora.  
La funzione si attiva automaticamente dopo 5 secondi.  
Quando si conclude il tempo impostato, viene emesso un segnale acustico.

**Passaggio 3** Premere un tasto per interrompere il segnale.

**Passaggio 4** Portare la manopola nella posizione di spegnimento.

## Come annullare: Funzioni dell'orologio

**Passaggio 1**  - premere ripetutamente fino a quando il simbolo della funzione orologio inizia a lampeggiare.

**Passaggio 2** Tenere premuto: .  
La funzione orologio si disattiva dopo pochi secondi.

## 9. UTILIZZO DEGLI ACCESSORI



### AVVERTENZA!

Fare riferimento ai capitoli sulla sicurezza.

### 9.1 Inserimento di accessori

Un piccolo rientro sulla parte superiore aumenta il livello di sicurezza. Gli incavi

fungono anche da dispositivi antiribaltamento. Il bordo alto intorno al ripiano evita che le pentole scivolino dal ripiano.

#### Griglia:

Spingere il ripiano fra le guide del supporto e verificare che i piedini siano rivolti verso il basso.

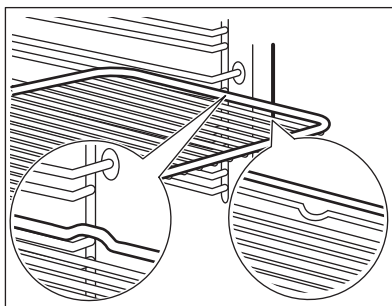

#### Lamiera dolci /Leccarda:

Spingere la lamiera tra le guide del supporto ripiano.

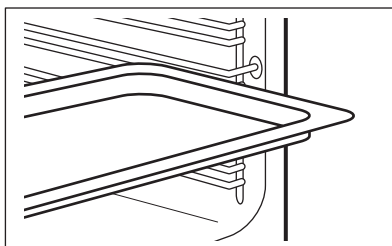

### **Griglia, Lamiera dolci /Leccarda:**

Spingere il vassoio tra le guide del supporto ripiano e il ripiano a filo sulle guide sovrastanti.

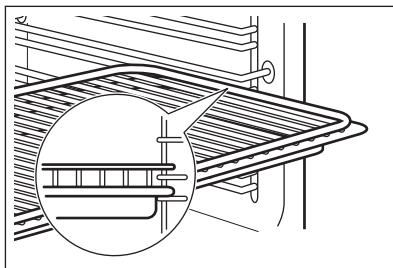

## **10. FUNZIONI AGGIUNTIVE**

### **10.1 Ventola di raffreddamento**

Quando il forno è in funzione, la ventola di raffreddamento si accende in modo automatico per tenere fresche le superfici del forno. Dopo aver spento il forno, la ventola di raffreddamento potrebbe continuare a funzionare fino a che il forno non si è raffreddato.

### **10.2 Termostato di sicurezza**

Un utilizzo inappropriato del forno o componenti difettose possono provocare un

surriscaldamento pericoloso. Per evitare che questo accada, il forno è dotato di un termostato di sicurezza che interrompe l'alimentazione della corrente elettrica. All'abbassamento della temperatura, il forno si riaccende automaticamente.

## **11. CONSIGLI E SUGGERIMENTI UTILI**



Fare riferimento ai capitoli sulla sicurezza.

### **11.1 Consigli di cottura**

Il forno presenta cinque posizioni di inserimento.

Contare le posizioni della griglia dal basso del forno.

Il vostro nuovo forno può cuocere o arrostitire in modo differente rispetto al forno posseduto in precedenza. Le seguenti tabelle offrono le impostazioni standard di temperatura, tempo di cottura e posizione ripiano.

Qualora non si trovino le impostazioni per una ricetta speciale, cercarne una simile.

Il forno è dotato di un sistema speciale che fa circolare l'aria e ricicla costantemente il vapore. Con questo sistema è possibile

cuocere in un ambiente pieno di vapore, mantenendo il cibo soffice all'interno e croccante all'esterno. Riduce sia il tempo di cottura che il consumo energetico.

#### **Cottura di dolci**

Non aprire lo sportello del forno prima che siano trascorsi 3/4 del tempo di cottura.

Se si usano due piastre da forno contemporaneamente, tenere un livello vuoto tra una e l'altra.

#### **Cottura di carni e pesce**

Usare una leccarda per alimenti ad alto contenuto di grassi, onde evitare che nel forno si formino macchie che non possono più essere rimosse.

Lasciare riposare la carne per circa 15 minuti prima di tagliarla, in modo da non perdere il sughetto.





Per evitare la formazione di fumo eccessivo nel forno durante la cottura arrosto, aggiungere dell'acqua nella leccarda. Per evitare la condensa di fumo, aggiungere acqua ogni volta che finisce.







Inizialmente, monitorare i risultati della cottura. Trovare le impostazioni migliori (livello di potenza, tempo di cottura, ecc.) per le proprie pentole, ricette e quantità quando si usa l'apparecchiatura.

### Tempi di cottura







I tempi di cottura dipendono dal tipo, dalla consistenza e dal volume del cibo.

## 11.2 Cottura al forno e cottura arrosti

TE	Cottura convenzionale		Cottura ventilata		(min)	
	 (°C)		 (°C)			
Pietanze frullate	170	2	160	3 (2 e 4)	45 - 60	Stampo per torta
Impasto per pasta frolla	170	2	160	3 (2 e 4)	20 - 30	Stampo per torta
Torta di ricotta	170	1	165	2	60 - 80	Stampo per torta, Ø 26 cm
Strudel	175	3	150	2	60 - 80	Lamiera dolci
Crostata	170	2	165	2	30 - 40	Stampo per torta, Ø 26 cm
Panettone, preriscaldare il forno vuoto	160	2	150	2	90 - 120	Stampo per torta, Ø 20 cm
Plum cake, preriscaldare il forno vuoto	175	1	160	2	50 - 60	Stampo per pane
Muffin	170	3	140 - 150	3	20 - 30	Lamiera dolci
Muffin, due livelli	-	-	140 - 150	2 e 4	25 - 35	Lamiera dolci
Muffin, tre livelli	-	-	140 - 150	1, 3 e 5	30 - 45	Lamiera dolci
Biscotti	140	3	140 - 150	3	30 - 35	Lamiera dolci
Biscotti, due livelli	-	-	140 - 150	2 e 4	35 - 40	Lamiera dolci
Biscotti, tre livelli	-	-	140 - 150	1, 3 e 5	35 - 45	Lamiera dolci
Meringhe	120	3	120	3	80 - 100	Lamiera dolci
Meringhe, due livelli, preriscaldare il forno vuoto	-	-	120	2 e 4	80 - 100	Lamiera dolci
Focaccine, preriscaldare il forno vuoto	190	3	190	3	12 - 20	Lamiera dolci
Eclair	190	3	170	3	25 - 35	Lamiera dolci







 TORTE	Cottura convenzionale		Cottura ventilata		 (min)	
	 (°C)		 (°C)			
Eclair, due livelli	-	-	170	2 e 4	35 - 45	Lamiera dolci
Crostatine	180	2	170	2	45 - 70	Stampo per torta, Ø 20 cm
Torta di frutta farcita	160	1	150	2	110 - 120	Stampo per torta, Ø 24 cm

Preriscaldare il forno vuoto.

 PANE E PIZZA	Cottura convenzionale		Cottura ventilata		 (min)	
	 (°C)		 (°C)			
Pane bianco, 1 - 2 pezzi, 0,5 kg ciascuno	190	1	190	1	60 - 70	-
Pane di segale, il preriscaldamento non è necessario	190	1	180	1	30 - 45	Stampo per pane
Panini, 6 - 8 panini	190	2	180	2 (2 e 4)	25 - 40	Lamiera dolci
Pizza	230 - 250	1	230 - 250	1	10 - 20	Vassoio smaltato
Focaccine	200	3	190	3	10 - 20	Lamiera dolci





Preriscaldare il forno vuoto.







Utilizzare la forma della torta.

 SFORMATI	Cottura convenzionale		Cottura ventilata		 (min)
	 (°C)		 (°C)		
Flan di pasta, il preriscaldamento non è necessario	200	2	180	2	40 - 50
Flan di verdure, il preriscaldamento non è necessario	200	2	175	2	45 - 60
Quiche	180	1	180	1	50 - 60
Lasagne	180 - 190	2	180 - 190	2	25 - 40
Cannelloni	180 - 190	2	180 - 190	2	25 - 40





Utilizzare la seconda posizione del ripiano.

Utilizzare il ripiano metallico.

 <b>CARNE</b>	<b>Cottura convenzionale</b>	<b>Cottura ventilata</b>	
	 (°C)	 (°C)	(min)
Manzo	200	190	50 - 70
Maiale	180	180	90 - 120
Vitello	190	175	90 - 120
Roastbeef inglese, al sangue	210	200	50 - 60
Roastbeef inglese, cottura media	210	200	60 - 70
Roastbeef inglese, ben cotto	210	200	70 - 75

 <b>CARNE</b>	<b>Cottura convenzionale</b>		<b>Cottura ventilata</b>		 (min)
	 (°C)		 (°C)		
Spalla di maiale, con cotenna	180	2	170	2	120 - 150
Stico di maiale, 2 pezzi	180	2	160	2	100 - 120
Cosciotto di agnello	190	2	175	2	110 - 130
Pollo intero	220	2	200	2	70 - 85
Tacchino intero	180	2	160	2	210 - 240
Anatra intera	175	2	220	2	120 - 150
Oca intera	175	2	160	1	150 - 200
Coniglio, in pezzi	190	2	175	2	60 - 80
Lepre, tagliata a pezzi	190	2	175	2	150 - 200
Fagiano intero	190	2	175	2	90 - 120

Utilizzare la seconda posizione del ripiano.

 <b>PESCE</b>	<b>Cottura convenzionale</b>	<b>Cottura ventilata</b>	 (min)
	 (°C)	 (°C)	
Trota / Orata, 3 - 4 pesci	190	175	40 - 55
Tonno /Salmone, 4 - 6 filetti	190	175	35 - 60







## 11.3 Grill

Preriscaldare il forno vuoto.

Utilizzare la quarta posizione del ripiano.

Grigliare con l'impostazione della temperatura massima.



 <b>GRILL</b>	 (kg)	 (min) <b>Primo lato</b>	 (min) <b>Secondo lato</b>
Bistecche di filetto, 4 pezzi	0,8	12 - 15	12 - 14
Bistecca di manzo, 4 pezzi	0,6	10 - 12	6 - 8
Salsicce, 8	-	12 - 15	10 - 12
Braciole di maiale, 4 pezzi	0,6	12 - 16	12 - 14
Mezzo pollo, 2	1	30 - 35	25 - 30
Kebab, 4	-	10 - 15	10 - 12
Petto di pollo, 4 pezzi	0,4	12 - 15	12 - 14
Hamburgers, 6	0,6	20 - 30	-
Filetto di pesce, 4 pezzi	0,4	12 - 14	10 - 12
Toast farciti, 4 - 6	-	5 - 7	-
Toast, 4 - 6	-	2 - 4	2 - 3



## 11.4 Turbo Grill

Preriscaldare il forno vuoto.



Utilizzare la prima o la seconda posizione del ripiano.



Per calcolare il tempo multiplo di cottura arrosto indicato nella tabella seguente in base ai centimetri di spessore del raccordo.

 <b>MANZO</b>	 (°C)	 (min)
Roastbeef o filetto al sangue	190 - 200	5 - 6
Roastbeef o filetto, cottura media	180 - 190	6 - 8
Roastbeef o filetto, ben cotto	170 - 180	8 - 10

 <b>MAIALE</b>	 (°C)	 (min)
Spalla / Coppa / Coscia, 1 - 1,5 kg	160 - 180	90 - 120
Braciole / Costoletta di maiale, 1 - 1,5 kg	170 - 180	60 - 90
Polpettone di carne, 0,75 - 1 kg	160 - 170	50 - 60
Stinco di maiale, precotto, 0,75 - 1 kg	150 - 170	90 - 120



  

 <b>VITELLO</b>	 (°C)	 (min)
Arrosto di vitello, 1 kg	160 - 180	90 - 120
Stinco di vitello, 1,5 - 2 kg	160 - 180	120 - 150

 <b>AGNELLO</b>	 (°C)	 (min)
---	--	---

Coscia d'agnello / Arrosto di agnello, 1 - 1,5 kg	150 - 170	100 - 120
---	-----------	-----------

Sella d'agnello, 1 - 1,5 kg	160 - 180	40 - 60
-----------------------------	-----------	---------

 <b>POLLAME</b>	 (°C)	 (min)
---	--	---

Pollame, porzioni, 0,2 - 0,25 kg ciascuno	200 - 220	30 - 50
---	-----------	---------

Mezzo pollo, 0,4 - 0,5 kg ciascuno	190 - 210	35 - 50
------------------------------------	-----------	---------



Pollo, pollastra, 1 - 1,5 kg	190 - 210	50 - 70
------------------------------	-----------	---------

Anatra, 1,5 - 2 kg	180 - 200	80 - 100
--------------------	-----------	----------

Oca, 3,5 - 5 kg	160 - 180	120 - 180
-----------------	-----------	-----------

Tacchino, 2,5 - 3,5 kg	160 - 180	120 - 150
------------------------	-----------	-----------

Tacchino, 4 - 6 kg	140 - 160	150 - 240
--------------------	-----------	-----------

 <b>PESCE (AL VAPORE)</b>	 (°C)	 (min)
---	--	---

Pesce intero, 1 - 1,5 kg	210 - 220	40 - 60
--------------------------	-----------	---------

## 11.5 Essiccazione - Cottura ventilata

Coprire le teglie con carta resistente al grasso o carta da forno.

## 11.6 Cottura ventilata umida - accessori consigliati

Usare scatole e contenitori scuri e non riflettenti. Assorbono meglio il calore rispetto al colore chiaro e ai piatti riflettenti.



Teglia da pizza

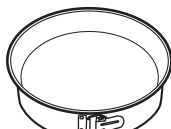

Pirofila



Pirofile monoporzione



Tortiera per flan

Per ottenere risultati migliori, spegnere il forno a metà del tempo di asciugatura, aprire lo sportello e lasciarlo raffreddare per una notte per completare l'asciugatura.

Per 1 teglia usare la terza posizione ripiano.

Per 2 teglie usare la prima e quarta posizione ripiano.

 <b>VERDURE</b>	 (°C)	 (ore)
--	--	--

Fagioli	60 - 70	6 - 8
---------	---------	-------

Peperoni	60 - 70	5 - 6
----------	---------	-------

Verdure per minestrone	60 - 70	5 - 6
------------------------	---------	-------

Funghi	50 - 60	6 - 8
--------	---------	-------

Erbette	40-50	2 - 3
---------	-------	-------

Impostare la temperatura su 60 - 70 °C.

 <b>FRUTTA</b>	 (ore)
---	---

Prugne	8 - 10
--------	--------

Albicocche	8 - 10
------------	--------

Fette di mela	6 - 8
---------------	-------

Pere	6 - 9
------	-------

Scura, non riflettente  
28 cm di diametro





Scura, non riflettente  
26 cm di diametro

Ceramica  
diametro 8 cm, al-  
tezza 5 cm

Scura, non riflettente  
28 cm di diametro

## 11.7 Cottura ventilata umida

Per ottenere i risultati migliori, attenersi ai suggerimenti elencati nella tabella sottostante.

		 (°C)		 (min.)
Roll dolci, 12 pezzi	vassoio di cottura o leccarda	175	3	40 - 50
Panini, 9 pezzi	vassoio di cottura o leccarda	180	2	35 - 45
Pizza surgelata, 0,35 kg	ripiano a filo	180	2	45 - 55
Rotolo con marmellata	vassoio di cottura o leccarda	170	2	30 - 40
Brownie	vassoio di cottura o leccarda	170	2	45 - 50
Soufflé, 6 pezzi	stampini di ceramica sulla griglia	190	3	45 - 55
Base pan di Spagna	teglia per timballo su griglia	180	2	35 - 45
Pan di Spagna	piatto da forno su griglia	170	2	35 - 50
Pesce al vapore, 0,3 kg	vassoio di cottura o leccarda	180	2	35 - 45
Pesce intero, 0,2 kg	vassoio di cottura o leccarda	180	3	25 - 35
Filetto di pesce, 0,3 kg	teglia per pizza su griglia	170	3	30 - 40
Carne al vapore, 0,25 kg	vassoio di cottura o leccarda	180	3	35 - 45
Shashlik, 0,5 kg	vassoio di cottura o leccarda	180	3	40 - 50
Cookie, 16 pezzi	vassoio di cottura o leccarda	150	2	30 - 45
Macarons, 20 pezzi	vassoio di cottura o leccarda	180	2	45 - 55
Muffin, 12 pezzi	vassoio di cottura o leccarda	170	2	30 - 40
Pasta saporita, 16 pezzi	vassoio di cottura o leccarda	170	2	35 - 45
Biscotti di pasta frolla, 20 pezzi	vassoio di cottura o leccarda	150	2	40 - 50
Tortine, 8 pezzi	vassoio di cottura o leccarda	170	2	30 - 40
Verdure, al vapore, 0,4 kg	vassoio di cottura o leccarda	180	2	35 - 45
Omelette vegetariana	teglia per pizza su griglia	180	3	35 - 45



(°C)



(min.)

Verdure alla mediterranea, 0,7 kg

vassoio di cottura o leccarda

180

4

35 - 45

## 11.8 Informazioni per gli istituti di prova

Test secondo IEC 60350-1.



(°C)



(min)



Dolcetti, 20 per lamiera dolci

Cottura convenzionale

Vassoio da forno

3

170

20 - 30

-

Dolcetti, 20 per lamiera dolci

Cottura ventilata

Vassoio da forno

3

150 - 160

20 - 35

-

Dolcetti, 20 per lamiera dolci

Cottura ventilata

Vassoio da forno

2 e 4

150 - 160

20 - 35

-

Torta di mele, 2 stampi Ø20 cm

Cottura convenzionale

Ripiano a filo

2

180

70 - 90

-

Torta di mele, 2 stampi Ø20 cm

Cottura ventilata

Ripiano a filo

2

160

70 - 90

-

Sponge cake, stampo per torta Ø26 cm

Cottura convenzionale

Ripiano a filo

2

170

40 - 50

Preriscaldare il forno per 10 minuti.

Sponge cake, stampo per torta Ø26 cm

Cottura ventilata

Ripiano a filo

2

160

40 - 50

Preriscaldare il forno per 10 minuti.

Sponge cake, stampo per torta Ø26 cm

Cottura ventilata

Ripiano a filo

2 e 4

160

40 - 60

Preriscaldare il forno per 10 minuti.

Frollini al burro

Cottura ventilata

Vassoio da forno

3

140 - 150

20 - 40

-

Frollini al burro

Cottura ventilata

Vassoio da forno

2 e 4

140 - 150

25 - 45

-

Frollini al burro

Cottura convenzionale







Vassoio da forno

3

140 - 150

25 - 45

-

						
				(°C)	(min)	
Toast, 4 - 6 pezzi	Grill	Ripiano a filo	4	max.	2 - 3 minuti sul primo lato; 2 - 3 minuti sul secondo lato	Preriscaldare il forno per 3 minuti.
Burger di manzo, 6 pezzi, 0,6 kg	Grill	Ripiano metallico e leccarda	4	max.	20 - 30	Mettere il ripiano metallico al quarto livello e la leccarda al terzo livello del forno. Girare il cibo a metà cottura. Preriscaldare il forno per 3 minuti.

## 12. PULIZIA E CURA



### AVVERTENZA!

Fare riferimento ai capitoli sulla sicurezza.

### 12.1 Note sulla pulizia



#### Agenti di pulizia

Pulire la parte anteriore del forno con un panno morbido imbevuto di acqua tiepida e detergente delicato. Pulire e controllare la guarnizione della porta attorno al telaio della cavità.

Servirsi di una soluzione detergente per pulire le superfici metalliche.

Pulire le macchie con un detergente delicato.



#### Uso quotidiano

Pulire la cavità dopo ogni utilizzo. L'accumulo di grasso o di altri residui potrebbe causare un incendio.

L'umidità può formare condensa nel forno o sui pannelli di vetro dello sportello. Per ridurre la condensa, mettere in funzione il forno 10 minuti prima di iniziare a cucinare. Non lasciare le vivande nel forno per più di 20 minuti. Asciugare la cavità con un panno morbido dopo ogni uso.



#### Accessori

Pulire tutti gli accessori dopo ogni uso e lasciarli asciugare. Utilizzare un panno morbido imbevuto di acqua tiepida e un detergente delicato. Non pulire gli accessori in lavastoviglie.

Non pulire gli accessori anti-aderenti con agenti abrasivi o oggetti appuntiti.

### 12.2 Come togliere: Supporti ripiano

Rimuovere i supporti ripiano per pulire il forno.

**Fase 1** Spegner il forno e attendere che sia freddo.

**Fase 2** Sfilare dapprima la guida di estrazione dalla parete laterale tirandola in avanti.

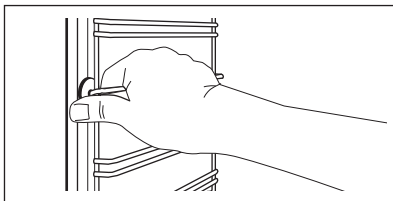

**Fase 3** Sfilare la guida di estrazione posteriore dalla parete laterale e toglierla.

**Fase 4** Installare i supporti griglia seguendo al contrario la procedura indicata.

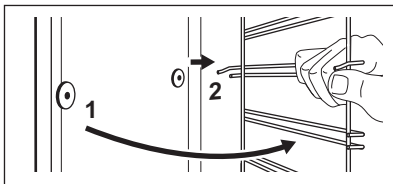

## 12.3 Come rimuovere e installare: Porta

La porta del forno è dotata di tre pannelli in vetro. È possibile rimuovere la porta ed i pannelli interni in vetro per pulirli. Leggere tutte le istruzioni "Rimozione e installazione della porta" prima di togliere i pannelli in vetro.



### ATTENZIONE!

Non utilizzare il forno senza i pannelli in vetro.

**Fase 1** Aprire completamente la porta e individuare la cerniera sul lato destro della stessa.

**Fase 2** Usare un cacciavite per sollevare e ruotare completamente il lato cerniera del lato destro.

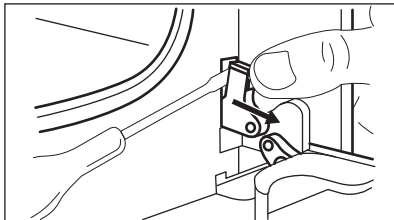

**Fase 3** Individuare la cerniera sul lato sinistro della porta.

**Fase 4** Alzare e ruotare la leva completamente sulla cerniera sinistra.

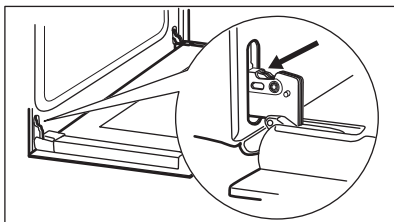

**Fase 5** Chiudere la porta del forno fino alla prima posizione di apertura circa metà. Quindi sollevare e tirare in avanti la porta sfilandola dalla sua sede.

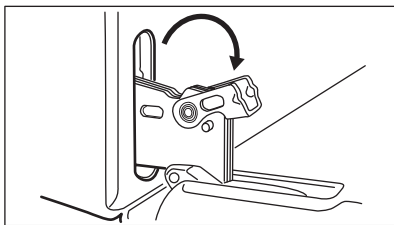

**Fase 6** Appoggiare la porta su una superficie stabile e coperta da un panno morbido.

**Fase 7** Afferrare sui due lati la guida della porta (B) sul bordo superiore della stessa e premere verso l'interno per rilasciare la chiusura a scatto.

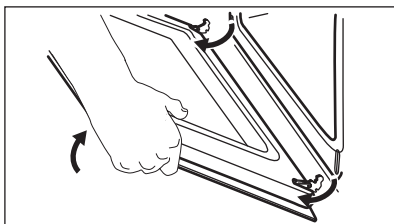

**Fase 8** Rimuovere la copertura tirandola in avanti

**Fase 9** Tenere i pannelli in vetro della porta per l'estremità superiore ed estrarli con attenzione, uno alla volta. Iniziare dal pannello superiore. Verificare che il vetro scorra completamente fino a uscire dai supporti.

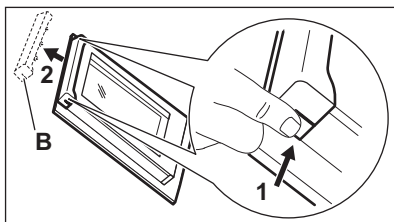

**Fase 10** Pulire il pannello di vetro con dell'acqua saponata. Asciugare i pannelli di vetro facendo attenzione. Non pulire i pannelli in vetro in lavastoviglie.

**Fase 11** Al termine della pulizia, installare i pannelli in vetro e la porta del forno.

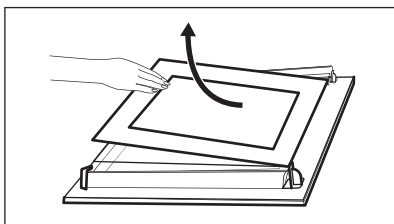

Assicurarsi di rimontare i pannelli in vetro (A e B) nell'ordine esatto. Controllare il simbolo / la stampa sul lato del pannello in vetro, ciascuno dei pannelli in vetro è diverso per semplificare le operazioni di smontaggio e montaggio.

Se installato correttamente, il profilo della porta emette un clic.

Accertarsi di installare il pannello intermedio in vetro nelle sedi corrette.

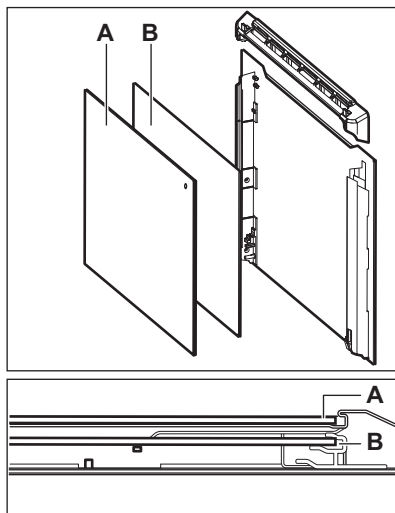

## 12.4 Come sostituire: Lampadina



### AVVERTENZA!

Pericolo di scosse elettriche.  
La lampada potrebbe essere calda.

Tenere sempre la lampadina alogena con uno straccio, per evitare che dei residui di grasso vi brucino sopra.

### Prima di sostituire la lampadina:

Fase 1	Fase 2	Fase 3
Spegnere il forno. Attendere che il forno sia freddo.	Estrarre la spina dalla presa di corrente.	Appoggiare un panno sul fondo della cavità.

## Lampadina posteriore

**Fase 1** Girare il rivestimento di vetro per toglierlo.

**Fase 2** Pulire il rivestimento di vetro.

**Fase 3** Sostituire la lampadina con una adatta, termoresistente fino a 300 °C.

**Fase 4** Installare la calotta di vetro.

## 13. RISOLUZIONE DEI PROBLEMI



### AVVERTENZA!

Fare riferimento ai capitoli sulla sicurezza.

### 13.1 Cosa fare se...

In tutti i casi non inclusi in questa tabella si prega di contattare un Centro di Assistenza Autorizzato.



Problema	Controllare se...
Il forno non si scalda.	È scattato il fusibile.
La guarnizione della porta è danneggiata.	Non utilizzare il forno. Contattare un Centro di Assistenza Autorizzato.
Il display indica "12.00".	Si è verificata un'interruzione dell'alimentazione elettrica. Impostare l'ora.
La lampadina non si accende.	La lampada è bruciata.

## 13.2 Dati Assistenza

Qualora non sia possibile trovare una soluzione al problema, contattare il rivenditore o il Centro di Assistenza Autorizzato.

Le informazioni necessarie per il Centro di Assistenza si trovano sulla targhetta dei dati. La targhetta si trova sul telaio anteriore del forno. Non rimuovere la targhetta dei dati dalla cavità del forno.

### Consigliamo di annotarli in questo spazio:

Modello (MOD.) .....

Codice Prodotto (PNC) .....

Numero di serie (S.N.) .....

## 14. EFFICIENZA ENERGETICA

### 14.1 Informazioni sul prodotto e Scheda informativa sul prodotto\*

Nome fornitore	AEG
Identificativo modello	BEE431011M 949496317
Indice di efficienza energetica	95.3
Classe di efficienza energetica	A
Consumo di energia con un carico standard, in modalità tradizionali	0.93 kWh/ciclo
Consumo di energia con un carico standard, in modalità ventola forzata	0.81 kWh/ciclo
Numero di cavità	1
Fonte di calore	Elettricità
Volume	72 l
Tipo di forno	Forno a incasso
Massa	30.2 kg

\* Per l'Unione europea secondo i regolamenti UE 65/2014 e 66/2014.  
Per la Repubblica di Bielorussia ai sensi di STB 2478-2017, appendice G; STB 2477-2017, allegati A e B.  
Per l'Ucraina secondo 568/32020.

La classe di efficienza energetica non è applicabile alla Russia.

EN 60350-1 - Apparecchiature elettriche per la cottura per uso domestico - Parte 1: Cucine, forni, forni a vapore e grill - Metodi per la misura delle prestazioni.

## 14.2 Risparmio energetico



Il forno è dotato di funzioni che consentono di aiutarvi a risparmiare energia durante le operazioni di cottura di tutti i giorni.

Verificare che la porta del forno sia chiusa quando lo stesso è in funzione. Non aprire la porta del forno con eccessiva frequenza in fase di cottura. Tenere pulita la guarnizione della porta e verificare che sia saldamente fissata in posizione.

Servirsi di pentole in metallo per migliorare il risparmio energetico.

Ove possibile, non pre-riscaldare il forno prima della cottura.

Ridurre quanto più possibile gli intervalli fra le diverse operazioni di cottura quando vengono preparati più piatti contemporaneamente.

### Cucinare con ventola

Ove possibile, servirsi delle funzioni di cottura con la ventola per risparmiare energia.

### Calore residuo

Quando la durata di cottura è superiore ai 30 minuti, ridurre la temperatura del forno al minimo 3-10 minuti prima della fine del processo di cottura. Il calore residuo all'interno del forno proseguirà la cottura.

Utilizzare il calore residuo per scaldare altri piatti.

### Tenere in caldo gli alimenti

Scegliere l'impostazione di temperatura più bassa per usare il calore residuo e tenere calda la pietanza.

### Cottura ventilata umida

Funzione progettata per risparmiare energia in fase di cottura.

## 15. CONSIDERAZIONI SULL'AMBIENTE

Riciclare i materiali con il simbolo . Buttare l'imballaggio negli appositi contenitori per il riciclaggio. Aiutare a proteggere l'ambiente e la salute umana e a riciclare rifiuti derivanti da apparecchiature elettriche ed elettroniche. Non smaltire le apparecchiature che

riportano il simbolo  insieme ai normali rifiuti domestici. Portare il prodotto al punto di riciclaggio più vicino o contattare il comune di residenza.

## PARA UNOS RESULTADOS PERFECTOS

Gracias por elegir este producto AEG. Lo hemos creado para brindarle un rendimiento impecable durante muchos años, con tecnologías innovadoras que lo ayudan a simplificar la vida, características que quizás no encuentre en los electrodomésticos comunes. Dedique unos minutos a leer este documento para sacarle el máximo partido.

Visite nuestro sitio web para:



Obtener consejos, folletos, soluciones a problemas e información de servicio y reparación:

**[www.aeg.com/support](http://www.aeg.com/support)**



Registrar su producto para recibir un mejor servicio:

**[www.registeraeg.com](http://www.registeraeg.com)**



Comprar accesorios, artículos de consumo y piezas de recambio originales para su aparato:

**[www.aeg.com/shop](http://www.aeg.com/shop)**

## ATENCIÓN AL CLIENTE Y SERVICIO

Le recomendamos que utilice recambios originales.

Cuando se ponga en contacto con nuestro Centro de servicio técnico, asegúrese de tener los siguientes datos disponibles: Modelo, código numérico del producto (PNC), número de serie.

La información se encuentra en la placa de características.

 Advertencia / Precaución - Información sobre seguridad

 Información general y consejos

 Información relativa al medioambiente

Salvo modificaciones.

## CONTENIDO

1. INFORMACIÓN SOBRE SEGURIDAD.....	108
2. INSTRUCCIONES DE SEGURIDAD.....	109
3. INSTALACIÓN.....	112
4. DESCRIPCIÓN DEL PRODUCTO.....	114
5. PANEL DE MANDOS.....	114
6. ANTES DEL PRIMER USO.....	115
7. USO DIARIO.....	115
8. FUNCIONES DEL RELOJ.....	116
9. USO DE LOS ACCESORIOS.....	118
10. FUNCIONES ADICIONALES.....	119
11. CONSEJOS.....	120
12. MANTENIMIENTO Y LIMPIEZA.....	128
13. SOLUCIÓN DE PROBLEMAS.....	131
14. EFICACIA ENERGÉTICA.....	132

## 1. ⚠ INFORMACIÓN SOBRE SEGURIDAD

Antes de instalar y utilizar el aparato, lea atentamente las instrucciones facilitadas. El fabricante no se hace responsable de lesiones o daños producidos como resultado de una instalación o un uso incorrectos. Conserve siempre estas instrucciones en lugar seguro y accesible para futuras consultas.

### 1.1 Seguridad de niños y personas vulnerables

- Este aparato puede ser utilizado por niños de 8 años en adelante y personas cuyas capacidades físicas, sensoriales o mentales estén disminuidas o que carezcan de la experiencia y conocimientos suficientes para manejarlo, siempre que cuenten con las instrucciones o la supervisión sobre el uso del electrodoméstico de forma segura y comprendan los riesgos. Hay que mantener alejados del producto a los niños de menos de 8 años, así como a las personas con minusvalías importantes y complejas, salvo que estén bajo supervisión continua.
- No deje que los niños jueguen con el aparato.
- Mantenga todo el material de embalaje fuera del alcance de los niños y deséchelo de forma adecuada.
- **ADVERTENCIA:** Mantenga a los niños y mascotas alejados del aparato cuando esté funcionando o enfriándose. Las partes accesibles se calientan durante el uso.
- Si este aparato tiene un bloqueo de seguridad para niños, debe activarlo.
- La limpieza y mantenimiento de usuario del aparato no podrán ser realizados por niños sin supervisión.

### 1.2 Seguridad general

- Solo un electricista cualificado puede instalar este aparato y sustituir el cable.
- **ADVERTENCIA:** El aparato y las piezas accesibles se calientan mucho durante el funcionamiento. Preste mucha atención para no tocar las resistencias.

- Utilice siempre guantes de horno cuando introduzca o retire accesorios o utensilios refractarios.
- Antes de realizar tareas de mantenimiento, desenchufe el aparato de la red eléctrica.
- **ADVERTENCIA:** Asegúrese de que el aparato está desconectado antes de reemplazar la lámpara con el fin de impedir que se produzca una descarga eléctrica.
- No utilice el aparato antes de instalarlo en la estructura empotrada.
- No utilice un limpiador a vapor para limpiar el aparato.
- No utilice limpiadores abrasivos ásperos ni rascadores de metal afilado para limpiar la puerta de cristal si no quiere arañar su superficie, lo que podría hacer que el cristal se hiciese añicos.
- Si el cable de alimentación eléctrica sufre algún daño, el fabricante, su servicio técnico autorizado o un profesional cualificado tendrán que cambiarlo para evitar riesgos eléctricos.
- Para quitar los carriles laterales, tire primero del frontal del carril y luego separe el extremo trasero de las paredes. Coloque los carriles laterales en el orden inverso.

## 2. INSTRUCCIONES DE SEGURIDAD

### 2.1 Instalación



#### **ADVERTENCIA!**

Sólo un técnico cualificado puede instalar el aparato.

- Retire todo el embalaje.
- No instale ni utilice un aparato dañado.
- Siga las instrucciones de instalación suministradas con el aparato.
- Tenga cuidado al mover el aparato, porque es pesado. Utilice siempre guantes de protección y calzado cerrado.
- No tire nunca del aparato sujetando el asa.
- Instale el aparato en un lugar seguro y adecuado que cumpla los requisitos de instalación.
- Respete siempre la distancia mínima entre el aparato y los demás electrodomésticos y mobiliario.

- Antes de montar el aparato, compruebe si la puerta del horno se abre sin limitaciones.
- El aparato dispone de un sistema de enfriamiento eléctrico. Debe utilizarse con alimentación eléctrica.

Altura mínima del armario (Altura mínima del armario debajo de la encimera)	590 (600) mm
---	--------------

Ancho del armario	560 mm
-------------------	--------

Profundidad del armario	550 (550) mm
-------------------------	--------------

Altura de la parte frontal del aparato	594 mm
---	--------

Altura de la parte trasera del aparato	576 mm
---	--------

Anchura de la parte frontal del aparato	595 mm
Anchura de la parte trasera del aparato	559 mm
Fondo del aparato	569 mm
Fondo empotrado del aparato	548 mm
Fondo con la puerta abierta	1022 mm
Tamaño mínimo de la abertura de ventilación. Abertura situada en la parte trasera inferior	560x20 mm
Longitud del cable de alimentación. El cable está en la esquina derecha de la parte trasera	1500 mm
Tornillos de montaje	4x25 mm

## 2.2 Conexión eléctrica



### ADVERTENCIA!

Riesgo de incendios y descargas eléctricas.

- Todas las conexiones eléctricas deben realizarlas electricistas cualificados.
- El aparato debe conectarse a tierra.
- Asegúrese de que los parámetros de la placa de características son compatibles con los valores eléctricos del suministro eléctrico.
- Utilice siempre una toma con aislamiento de conexión a tierra correctamente instalada.
- No utilice adaptadores de enchufes múltiples ni cables prolongadores.
- Asegúrese de no provocar daños en el enchufe ni en el cable de red. Si es necesario cambiar el cable de alimentación del aparato, debe hacerlo el centro de servicio técnico autorizado.
- Evite que el cable de red toque o entre en contacto con la puerta del aparato o con el hueco por debajo del aparato, especialmente mientras funciona o si la puerta está caliente.
- Los mecanismos de protección contra descargas eléctricas de componentes con corriente y aislados deben fijarse de forma que no puedan aflojarse sin utilizar herramientas.

- Conecte el enchufe a la toma de corriente únicamente cuando haya terminado la instalación. Asegúrese de tener acceso al enchufe del suministro de red una vez finalizada la instalación.
- Si la toma de corriente está floja, no conecte el enchufe.
- No desconecte el aparato tirando del cable de conexión a la red. Tire siempre del enchufe.
- Use únicamente dispositivos de aislamiento apropiados: línea con protección contra los cortocircuitos, fusibles (tipo tornillo que puedan retirarse del soporte), dispositivos de fuga a tierra y contactores.
- La instalación eléctrica debe tener un dispositivo de aislamiento que permita desconectar el aparato de todos los polos de la red. El dispositivo de aislamiento debe tener una apertura de contacto con una anchura mínima de 3 mm.
- El aparato se suministra con enchufe y cable de red.

### Tipos de cables aplicables para su instalación o cambio para Europa:

H07 RN-F, H05 RN-F, H05 RRF, H05 VV-F, H05 V2V2-F (T90), H05 BB-F

En lo que respecta a la sección del cable, consulte la potencia total que figura en la placa de características. También puede consultar la tabla:

Potencia total (W)	Sección del cable (mm <sup>2</sup> )
máximo 1380	3 x 0.75
máximo 2300	3 x 1
máximo 3680	3 x 1.5

El cable de tierra (cable verde/amarillo) debe tener 2 cm más que los cables de fase y del neutro (cables azul y marrón).

## 2.3 Uso



### ADVERTENCIA!

Riesgo de lesiones, quemaduras y descargas eléctricas o explosiones.

- Este aparato está diseñado exclusivamente para uso doméstico.
- No cambie las especificaciones de este aparato.
- Cerciórese de que los orificios de ventilación no están obstruidos.
- No deje nunca el aparato desatendido mientras está en funcionamiento.
- Desactive el aparato después de cada uso.
- Tenga cuidado al abrir la puerta del aparato cuando éste esté en funcionamiento. Pueden liberarse vapores calientes.
- No utilice el aparato con las manos mojadas ni cuando entre en contacto con el agua.
- No ejerza presión sobre la puerta abierta.
- No utilice el aparato como superficie de trabajo ni de almacenamiento.
- Abra la puerta del aparato con cuidado. El uso de ingredientes con alcohol puede generar una mezcla de alcohol y aire.
- Procure que no haya chispas ni fuego encendido cerca cuando se abra la puerta del aparato.
- No coloque productos inflamables ni objetos mojados con productos inflamables dentro, cerca o encima del aparato.



#### **ADVERTENCIA!**

Podría dañar el aparato.

- Para evitar daños o decoloraciones en el esmalte:
  - no coloque utensilios refractarios ni otros objetos directamente en la parte inferior del aparato.
  - no coloque papel de aluminio directamente en la parte inferior del interior del aparato.
  - No ponga agua directamente en el aparato caliente.
  - No deje platos húmedos ni comida en el aparato una vez finalizada la cocción.
  - Preste especial atención al desmontar o instalar los accesorios.
- La pérdida de color del esmalte o el acero inoxidable no afecta al rendimiento del aparato.
- Utilice una bandeja honda para pasteles húmedos. Los jugos de las frutas podrían ocasionar manchas permanentes.

- Este aparato está diseñado exclusivamente para cocinar. No debe utilizarse para otros fines, por ejemplo, como calefacción.
- Cocine siempre con la puerta del horno cerrada.
- Si el aparato se instala detrás de un panel de un mueble (por ejemplo una puerta) asegúrese de que la puerta nunca esté cerrada mientras funciona el aparato. El calor y la humedad pueden acumularse detrás de un panel del armario cerrado y provocar daños al aparato, el alojamiento o el suelo. No cierre del panel del armario hasta que el aparato se haya enfriado completamente después de su uso.

## 2.4 Mantenimiento y limpieza



#### **ADVERTENCIA!**

Existe riesgo de lesiones, incendios o daños al aparato.

- Antes de proceder con el mantenimiento, apague el aparato y desconecte el enchufe de la red.
- Asegúrese de que el aparato esté frío. Los paneles de cristal pueden romperse.
- Cambie inmediatamente los paneles de cristal de la puerta que estén dañados. Póngase en contacto con el servicio técnico autorizado.
- Tenga cuidado al desmontar la puerta del aparato. ¡La puerta es muy pesada!
- Limpie periódicamente el aparato para evitar el deterioro del material de la superficie.
- Limpie el aparato con un paño suave humedecido. Utilice solo detergentes neutros. No utilice productos abrasivos, estropajos duros, disolventes ni objetos metálicos.
- Si utiliza aerosoles de limpieza para hornos, siga las instrucciones de seguridad del envase.

## 2.5 Luces interiores



#### **ADVERTENCIA!**

Riesgo de descarga eléctrica.

- En cuanto a la(s) bombilla(s) de este producto y las de repuesto vendidas por separado: Estas bombillas están destinadas a soportar condiciones físicas

extremas en los aparatos domésticos, como la temperatura, la vibración, la humedad, o están destinadas a señalar información sobre el estado de funcionamiento del aparato. No están destinadas a utilizarse en otras aplicaciones y no son adecuadas para la iluminación de estancias domésticas.

- Utilice solo bombillas de las mismas características .

## 2.6 Asistencia

- Para reparar el aparato, póngase en contacto con el centro de servicio autorizado.

- Utilice solamente piezas de recambio originales.

## 2.7 Eliminación



### ADVERTENCIA!

Existe riesgo de lesiones o asfixia.

- Desconecte el aparato de la red.
- Corte el cable eléctrico cerca del aparato y deséchelo.
- Retire el pestillo de la puerta para evitar que los niños las mascotas queden atrapados en el aparato.

# 3. INSTALACIÓN



### ADVERTENCIA!

Consulte los capítulos sobre seguridad.

## 3.1 Empotrado



YouTube

[www.youtube.com/electrolux](http://www.youtube.com/electrolux)  
[www.youtube.com/aeg](http://www.youtube.com/aeg)

How to install your AEG/Electrolux  
Oven - Column installation

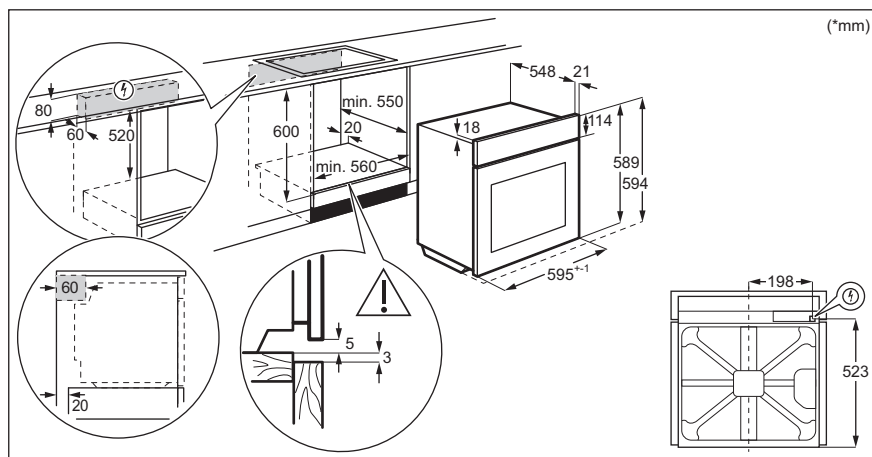



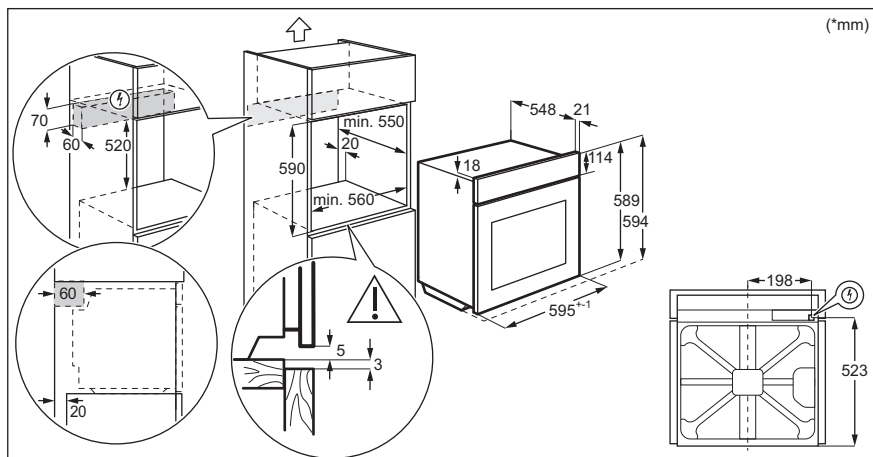

### 3.2 Fijación del horno al mueble

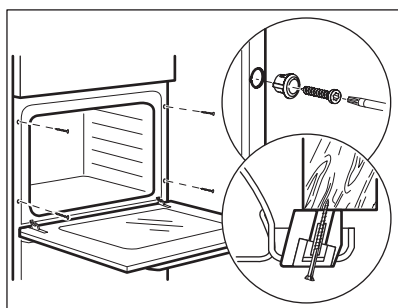

## 4. DESCRIPCIÓN DEL PRODUCTO

### 4.1 Descripción general

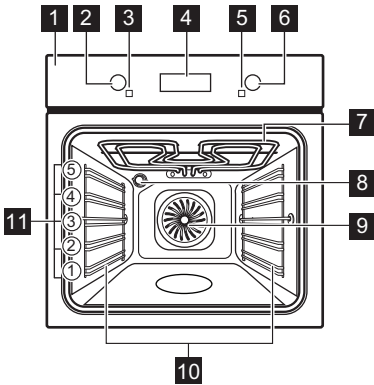

- 1 Panel de control
- 2 Mando de las funciones de cocción
- 3 Piloto/símbolo de alimentación
- 4 Pantalla
- 5 Indicador/símbolo de temperatura
- 6 Mando de control (para la temperatura)
- 7 Elemento calentador
- 8 Bombilla
- 9 Ventilador
- 10 Carril de apoyo, extraíble
- 11 Niveles para las rejillas

### 4.2 Accesorios

- **Parrilla**  
Para bandejas de horno, pastel en molde, asados.
- **Bandeja**

Para bizcochos y galletas.

- **Bandeja honda**  
Para hornear y asar o como bandeja grasera.

## 5. PANEL DE MANDOS

### 5.1 Mandos escamoteables

Para usar el aparato, presione el mando. El mando sale del alojamiento.

### 5.2 Sensores / botones

—	Para ajustar la hora.
⌚	Para ajustar una función de reloj.
+	Para ajustar la hora.

## 5.3 Pantalla

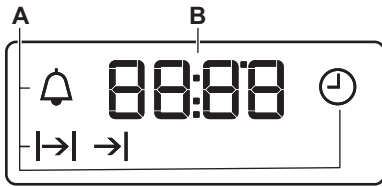

- A. Funciones del reloj
- B. Temporizador

## 6. ANTES DEL PRIMER USO



### ADVERTENCIA!

Consulte los capítulos sobre seguridad.

### 6.1 Antes del primer uso

El horno puede emitir olores y humos durante el precalentamiento. Asegúrese de que la sala esté ventilada.



Paso 1



Paso 2



Paso 3

Ajuste el reloj	Limpie el horno	Precaliente el horno vacío
<ol style="list-style-type: none"> <li>- pulse <b>+</b>, <b>-</b> para ajustar la hora. Después de unos 5 segundos, el parpadeo cesa y la pantalla indica la hora ajustada.</li> </ol>	<ol style="list-style-type: none"> <li>Retire todos los accesorios y carriles de apoyo extraíbles del horno.</li> <li>Limpie el horno y los accesorios con un paño suave humedecido en agua templada y jabón neutro.</li> </ol>	<ol style="list-style-type: none"> <li>Seleccione la temperatura máxima para la función: . Tiempo: 1 h.</li> <li>Seleccione la temperatura máxima para la función: . Tiempo: 15 min.</li> <li>Seleccione la temperatura máxima para la función: . Tiempo: 15 min.</li> </ol>

Apague el horno y espere a que esté frío. Coloque los accesorios y carriles de apoyo extraíbles en el horno.

## 7. USO DIARIO



### ADVERTENCIA!

Consulte los capítulos sobre seguridad.







### 7.1 Cómo configurar: Función de cocción





**Paso 1** Gire el mando del horno para seleccionar una función de cocción.

**Paso 2** Gire el mando de control para seleccionar la temperatura.

**Paso 3** Al terminar la cocción, gire los mandos hasta la posición de apagado para apagar el horno.

## 7.2 Funciones de cocción

Función de cocción	Aplicación
 Posición de apagado	El horno está apagado.
 Luz	Para encender la luz.
 Aire caliente	Para hornear en hasta tres posiciones de parrilla a la vez y para secar alimentos. Ajuste la temperatura entre 20 y 40 °C menos que para Cocción convencional.
 Horneado húmedo + ventil.	Función diseñada para ahorrar energía durante la cocción. Cuando se utiliza esta función, la temperatura del horno puede diferir de la temperatura programada. La potencia calorífica puede reducirse. Para más información, consulte el capítulo "Uso diario", Notas sobre: Horneado húmedo + ventil..
 Calor inferior	Para preparar pasteles con bases crujientes y conservar alimentos.
 Grill	Para asar al grill alimentos de poco espesor y tostar pan.

Función de cocción	Aplicación
 Grill Rápido	Para asar al grill trozos finos de comida en grandes cantidades y tostar pan.
 Grill Turbo	Para asar piezas de carne grandes o aves con hueso en una posición de bandeja. Para hacer gratenes y dorar.
 Función pizza	Para hornear pizza. Para obtener un dorado más intenso y una base más crujiente
 Cocción convencional	Para hornear y asar alimentos en una posición de bandeja.

## 7.3 Notas sobre: Horneado húmedo + ventil.

Esta función se utilizaba para cumplir con los requisitos de categoría de eficiencia energética y ecodiseño según EU 65/2014 y EU 66/2014. Pruebas conforme a EN 60350-1.





La puerta del horno debe estar cerrada durante la cocción para que la función no se interrumpa y que el horno funcione con la máxima eficiencia energética posible.

Para las instrucciones de cocción, consulte el capítulo "Consejos", Horneado húmedo + ventil.. Puede consultar recomendaciones generales para ahorrar energía en el capítulo "Eficiencia energética", bajo consumo energético.

## 8. FUNCIONES DEL RELOJ

### 8.1 Funciones del reloj



función de reloj	Aplicación
 Hora	Ajustar, modificar o comprobar la hora.

función de reloj	Aplicación
 Duración	Programar la duración del funcionamiento del horno.
 Hora de fin	Permite ajustar cuando se apaga el horno.
 Tiempo de retardo	Para combinar funciones: Duración y Hora de fin.
 Avisador	Para configurar una cuenta atrás. Esta función no influye en el funcionamiento del horno. Puede ajustar esta función cualquier momento, incluso si el horno está apagado.

## 8.2 Cómo ajustar: Funciones del reloj

### Cómo ajustar: Hora



 - parpadea al conectar el horno a la corriente eléctrica si ha habido un corte de corriente o si no está ajustado el temporizador.

 ,  - pulsa para ajustar la hora.

Después de unos 5 segundos, el parpadeo cesa y la pantalla indica la hora ajustada.

### Cómo cambiar: Hora

**Paso 1**  - pulsa repetidamente para cambiar la hora del día.  - empieza a parpadear.



**Paso 2**  ,  - pulsa para ajustar la hora.

Después de unos 5 segundos, el parpadeo cesa y la pantalla indica la hora ajustada.

### Cómo ajustar: Duración

**Paso 1** Programa una función y una temperatura del horno.

**Paso 2**  - pulsa repetidamente.  - empieza a parpadear.

**Paso 3**  ,  - pulsa para fijar la duración.

La pantalla muestra: .

 - parpadea cuando termina la hora ajustada. La señal suena y el horno se apaga.

**Paso 4** Pulsa cualquier tecla para detener la señal.





**Paso 5** Gira los mandos a la posición de apagado.

### Cómo ajustar: Hora de fin









**Paso 1** Programa una función y una temperatura del horno.

**Paso 2**  - pulsa repetidamente.  - empieza a parpadear.





### Cómo ajustar: Hora de fin

- Paso 3**  ,  - pulsa para ajustar la hora.  
La pantalla muestra: .  
 - parpadea cuando termina la hora ajustada. La señal suena y el horno se apaga.
- Paso 4** Pulsa cualquier tecla para detener la señal.
- Paso 5** Gira los mandos a la posición de apagado.



### Cómo ajustar: Tiempo de retardo

- Paso 1** Programa una función y una temperatura del horno.
- Paso 2**  - pulsa repetidamente.  - empieza a parpadear.
- Paso 3**  ,  - pulsa para ajustar la hora para: Duración.
- Paso 4** Pulse: .
- Paso 5**  ,  - pulsa para ajustar la hora para: Hora de fin.
- Paso 6** Pulse: .  
Al llegar a la hora ajustada, la señal suena y el horno se apaga.
- Paso 7** Pulsa cualquier tecla para detener la señal.
- Paso 8** Gira los mandos a la posición de apagado.

### Cómo ajustar: Avisador

- Paso 1**  - pulsa repetidamente.  - empieza a parpadear.
- Paso 2**  ,  - pulsa para ajustar la hora.  
La función empieza automáticamente tras 5 segundos.  
Al finalizar el tiempo programado, sonará la señal acústica.
- Paso 3** Pulsa cualquier tecla para detener la señal.
- Paso 4** Gira los mandos a la posición de apagado.

### Instrucciones para cancelar: Funciones del reloj

- Paso 1**  - pulsa repetidamente hasta que el símbolo de la función de reloj empiece a parpadear.
- Paso 2** Mantén pulsado: .  
La función de reloj se apaga después de unos segundos.

## 9. USO DE LOS ACCESORIOS



### ADVERTENCIA!

Consulte los capítulos sobre seguridad.

### 9.1 Inserción de accesorios

Una pequeña muesca en la parte superior aumenta la seguridad. Las hendiduras también son dispositivos anti-vuelco. El

borde elevado que rodea la bandeja evita que los utensilios de cocina resbalen de la parrilla.

**Parrilla:**

Inserte la parrilla entre las guías del carril y asegúrese de que las hendiduras apunten hacia abajo.

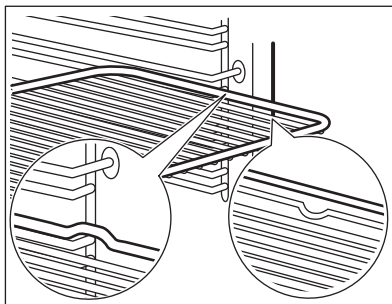

**Bandeja /Bandeja honda:**

Introduzca la bandeja entre las guías del carril de apoyo.

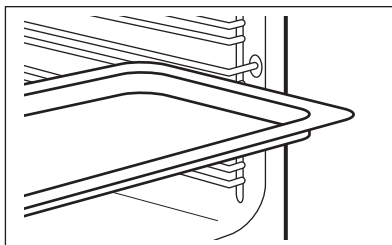

**Parrilla, Bandeja /Bandeja honda:**

Posicione la bandeja entre las guías del carril de apoyo y la parrilla en las guías de encima.

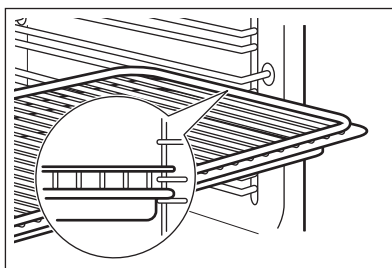

## 10. FUNCIONES ADICIONALES

### 10.1 Ventilador de enfriamiento

Cuando el horno funciona, el ventilador de enfriamiento se pone en marcha automáticamente para mantener frías las superficies del horno. Una vez apagado el horno, el ventilador sigue funcionando hasta enfriarlo totalmente.

### 10.2 Termostato de seguridad

El funcionamiento incorrecto del horno o los componentes defectuosos pueden provocar sobrecalentamientos peligrosos. Para evitarlo, el horno dispone de un termostato de seguridad que interrumpe la alimentación. El horno se vuelve a encender automáticamente cuando desciende la temperatura.

## 11. CONSEJOS



Consulte los capítulos sobre seguridad.

### 11.1 Recomendaciones de cocción

El horno tiene cinco niveles.

Cuente los niveles de las parrillas desde abajo hacia arriba.

El comportamiento de su horno puede ser diferente al del que tenía anteriormente. Las tablas siguientes le proporcionan los ajustes estándares de temperatura, tiempo de cocción y posición de la parrilla.

Si no encuentra los ajustes para una receta especial, busque otra similar.

El horno está dotado con un sistema especial que hace circular el aire y recicla constantemente el vapor. Gracias a este sistema puede cocinar con un entorno de vapor y mantener los alimentos blandos en su interior y crujientes en su exterior. Reduce el tiempo de cocción y el consumo de energía.

#### Repostería

No abra la puerta del horno antes de que transcurran 3/4 partes del tiempo de cocción establecido.

Si utiliza dos bandejas al mismo tiempo, deje un nivel libre entre ambas.

#### Carnes y pescados

Utilice una bandeja honda con los alimentos muy grasos para evitar que el horno quede manchado de forma permanente.

Antes de trincar la carne, déjela reposar unos 15 minutos, como mínimo, para que retenga los jugos.

Para evitar que se forme mucho humo en el horno, vierta un poco de agua en la bandeja honda. Para evitar la condensación de humos, añada agua después de cada vez que se seque.

#### Tiempos de cocción







Los tiempos de cocción dependen del tipo de alimento, de su consistencia y del volumen.

Inicialmente, supervise el rendimiento cuando cocine. Busque los ajustes óptimos (de calor, tiempo de cocción, etc.) para sus recipientes, recetas y cantidades cuando utilice este horno.







### 11.2 Horneado y asado







RE- POSTERÍA	Cocción convencional		Aire caliente		⏱ (min)	
	 (°C)	 2	 (°C)	 3 (2 y 4)		
Masas batidas	170	2	160	3 (2 y 4)	45 - 60	Molde de pastel
Masa con mantequilla	170	2	160	3 (2 y 4)	20 - 30	Molde de pastel
Tarta de queso (con suero)	170	1	165	2	60 - 80	Molde de pastel, Ø 26 cm
Strudel	175	3	150	2	60 - 80	Bandeja
Tarta de mermelada	170	2	165	2	30 - 40	Molde de pastel, Ø 26 cm



 <b>RE-POSTERÍA</b>	Cocción convencional		Aire caliente		 (min)	
	 (°C)		 (°C)			
Tronco de Navidad, precaliente el horno vacío	160	2	150	2	90 - 120	Molde de pastel, Ø 20 cm
Pastel de ciruelas, precaliente el horno vacío	175	1	160	2	50 - 60	Molde para pan
Muffins	170	3	140 - 150	3	20 - 30	Bandeja
Muffins, dos niveles	-	-	140 - 150	2 y 4	25 - 35	Bandeja
Muffins, tres niveles	-	-	140 - 150	1, 3 y 5	30 - 45	Bandeja
Galletas	140	3	140 - 150	3	30 - 35	Bandeja
Galletas, dos niveles	-	-	140 - 150	2 y 4	35 - 40	Bandeja
Galletas, tres niveles	-	-	140 - 150	1, 3 y 5	35 - 45	Bandeja
Merengues	120	3	120	3	80 - 100	Bandeja
Merengues, dos niveles, precaliente el horno vacío	-	-	120	2 y 4	80 - 100	Bandeja
Bollos, precaliente el horno vacío	190	3	190	3	12 - 20	Bandeja
Bollos rellenos de crema	190	3	170	3	25 - 35	Bandeja
Bollos rellenos de crema, dos niveles	-	-	170	2 y 4	35 - 45	Bandeja
Tartaletas	180	2	170	2	45 - 70	Molde de pastel, Ø 20 cm
Pastel de fruta	160	1	150	2	110 - 120	Molde de pastel, Ø 24 cm







Precaliente el horno vacío.

 <b>PAN Y PIZZA</b>	Cocción convencional		Aire caliente		 (min)	
	 (°C)		 (°C)			
Pan blanco, 1 - 2 trozos, 0,5 kg cada	190	1	190	1	60 - 70	-

 PAN Y PIZ- ZA	Cocción convencional		Aire caliente		 (min)	
	 (°C)		 (°C)			
Pan de centeno, no se necesita precalentar	190	1	180	1	30 - 45	Molde para pan
Pan/Rollitos, 6 - 8 panecillos	190	2	180	2 (2 y 4)	25 - 40	Bandeja
Pizza	230 - 250	1	230 - 250	1	10 - 20	Bandeja esmaltada
Bollitos	200	3	190	3	10 - 20	Bandeja





Precaliente el horno vacío.







Use el molde de repostería.

 FLANES	Cocción convencional		Aire caliente		 (min)
	 (°C)		 (°C)		
Pudin de pasta, no se necesita precalentar	200	2	180	2	40 - 50
Pudin de verduras, no se necesita precalentar	200	2	175	2	45 - 60
Quiches	180	1	180	1	50 - 60
Lasaña	180 - 190	2	180 - 190	2	25 - 40
Canelones	180 - 190	2	180 - 190	2	25 - 40





Use el segundo nivel.

Utilice la parrilla.

 CARNE	Cocción convencional	Aire caliente	 (min)
	 (°C)	 (°C)	
Carne de res	200	190	50 - 70
Cerdo	180	180	90 - 120
Ternera	190	175	90 - 120
Rosbif poco hecho	210	200	50 - 60
Rosbif en su punto	210	200	60 - 70
Rosbif muy hecho	210	200	70 - 75

 <b>CARNE</b>	Cocción convencional		Aire caliente		 (min)
	 (°C)		 (°C)		
Paletilla de cerdo, con corteza	180	2	170	2	120 - 150
Morcillo de cerdo, 2 trozos	180	2	160	2	100 - 120
Pata de cordero	190	2	175	2	110 - 130
Pollo entero	220	2	200	2	70 - 85
Pavo entero	180	2	160	2	210 - 240
Pato entero	175	2	220	2	120 - 150
Ganso entero	175	2	160	1	150 - 200
Conejo, en trozos	190	2	175	2	60 - 80
Liebre, en trozos	190	2	175	2	150 - 200
Faisán entero	190	2	175	2	90 - 120

Use el segundo nivel.





 <b>PESCADO</b>	Cocción convencional		Aire caliente		 (min)
	 (°C)		 (°C)		
Trucha / Pargo, 3 - 4 pescados	190		175		40 - 55
Atún / Salmón, 4 - 6 filetes	190		175		35 - 60

### 11.3 Grill

Precalente el horno vacío.

Use el cuarto nivel.

Grill con la temperatura ajustada al máximo.

 <b>GRILL</b>	 (kg)	 (min) 1ª cara	 (min) 2ª cara
	Filetes de solomillo, 4 piezas	0,8	12 - 15
Bistec de vaca, 4 piezas	0,6	10 - 12	6 - 8
Salchichas, 8	-	12 - 15	10 - 12
Chuletas de cerdo, 4 piezas	0,6	12 - 16	12 - 14
Pollo, medio, 2	1	30 - 35	25 - 30
Brochetas, 4	-	10 - 15	10 - 12





	(kg)	(min) 1ª cara	(min) 2ª cara
Pechuga de pollo, 4 piezas	0,4	12 - 15	12 - 14
Hamburguesas, 6	0,6	20 - 30	-
Filete de pescado, 4 piezas	0,4	12 - 14	10 - 12
Sándwiches tostados, 4 - 6	-	5 - 7	-
Tostadas, 4 - 6	-	2 - 4	2 - 3



## 11.4 Grill Turbo



Precaliente el horno vacío.



Use el primer o el segundo nivel.



Para calcular el tiempo de asado, multiplique el tiempo de la tabla siguiente por los centímetros de grosor del filete.



 <b>CARNE DE RES</b>	 (°C)	 (min)
Rosbif o filete, poco hecho	190 - 200	5 - 6
Rosbif o filete, al punto	180 - 190	6 - 8
Rosbif o filete, muy hecho	170 - 180	8 - 10



 <b>CERDO</b>	 (°C)	 (min)
Paletilla / Cuello / Jamón, 1 - 1,5 kg	160 - 180	90 - 120
Chuletas / Costillas, 1 - 1,5 kg	170 - 180	60 - 90
Pastel de carne, 0,75 - 1 kg	160 - 170	50 - 60
Codillo de cerdo precocinado, 0,75 - 1 kg	150 - 170	90 - 120

 <b>TERNERA</b>	 (°C)	 (min)
Ternera asada, 1 kg	160 - 180	90 - 120

 <b>TERNERA</b>	 (°C)	 (min)
Codillo de ternera, 1,5 - 2 kg	160 - 180	120 - 150

 <b>CORDERO</b>	 (°C)	 (min)
Pata de cordero / Cordero asado, 1 - 1,5 kg	150 - 170	100 - 120
Silla de cordero, 1 - 1,5 kg	160 - 180	40 - 60

 <b>AVES</b>	 (°C)	 (min)
Aves troceadas, 0,2 - 0,25 kg cada	200 - 220	30 - 50
Pollo, medio, 0,4 - 0,5 kg cada	190 - 210	35 - 50
Pollo, pularda, 1 - 1,5 kg	190 - 210	50 - 70
Pato, 1,5 - 2 kg	180 - 200	80 - 100
Ganso, 3,5 - 5 kg	160 - 180	120 - 180
Pavo, 2,5 - 3,5 kg	160 - 180	120 - 150
Pavo, 4 - 6 kg	140 - 160	150 - 240

 <b>PESCADO</b> (AL VAPOR)	 <b>(°C)</b>	 <b>(min)</b>
Pescado entero, 1 - 1,5 kg	210 - 220	40 - 60



## 11.5 Desecar alimentos - Aire caliente



Cubra las bandejas con papel vegetal o papel de hornear.

Para obtener mejores resultados, apague el horno a la mitad del tiempo de secado, abra la puerta y déjelo enfriar durante una noche para completar el secado.



Para 1 bandeja, use el tercer nivel.

Para 2 bandejas, use el primer y cuarto nivel.

 <b>VERDURAS</b>	 <b>(°C)</b>	 <b>(h)</b>
Judías	60 - 70	6 - 8

 <b>VERDURAS</b>	 <b>(°C)</b>	 <b>(h)</b>
Pimientos	60 - 70	5 - 6
Verduras para sopa	60 - 70	5 - 6
Setas	50 - 60	6 - 8
Hierbas aromáticas	40 - 50	2 - 3

Ajuste de temperatura 60 - 70 °C.

 <b>FRUTA</b>	 <b>(h)</b>
Ciruelas	8 - 10
Albaricoques	8 - 10
Manzanas en rodajas	6 - 8
Peras	6 - 9

## 11.6 Horneado húmedo + ventil.. accesorios recomendados

Utilice molde y recipientes oscuros y mates. Tiene mejor absorción del calor que los platos de color claro y brillantes.



**Bandeja para pizza**

Oscuro, mate  
28 cm de diámetro

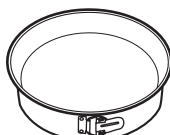

**Bandeja para hornear**

Oscuro, mate  
26 cm de diámetro



**Ramequines**

Cerámica  
8 cm de diámetro,  
5 cm de altura

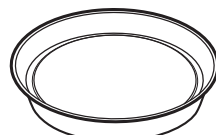





**Molde para base**

Oscuro, mate  
28 cm de diámetro







## 11.7 Horneado húmedo + ventil.

Para obtener el mejor resultado, siga las recomendaciones de la tabla siguiente.

		 (°C)		 (min)
Rollitos dulces, 12 piezas	bandeja o bandeja honda	175	3	40 - 50
Rollitos, 9 piezas	bandeja o bandeja honda	180	2	35 - 45
Pizza congelada, 0,35 kg	parrilla	180	2	45 - 55
Brazo de gitano	bandeja o bandeja honda	170	2	30 - 40
Brownie	bandeja o bandeja honda	170	2	45 - 50
Soufflé, 6 piezas	ramekin cerámico sobre parrilla	190	3	45 - 55
Base de masa brisé	molde de base sobre parrilla	180	2	35 - 45
Tarta Victoria	bandeja de hornear sobre parrilla	170	2	35 - 50
Pescado pochado, 0,3 kg	bandeja o bandeja honda	180	2	35 - 45
Pescado entero, 0,2 kg	bandeja o bandeja honda	180	3	25 - 35
Filete de pescado, 0,3 kg	molde para pizza sobre parrilla	170	3	30 - 40
Carne pochada, 0,25 kg	bandeja o bandeja honda	180	3	35 - 45
Shashlik, 0,5 kg	bandeja o bandeja honda	180	3	40 - 50
Galletas, 16 piezas	bandeja o bandeja honda	150	2	30 - 45
Mostachones de almendra, 20 piezas	bandeja o bandeja honda	180	2	45 - 55
Muffins, 12 piezas	bandeja o bandeja honda	170	2	30 - 40
Tarta salada, 16 piezas	bandeja o bandeja honda	170	2	35 - 45
Galletas crujientes de masa quebrada, 20 piezas	bandeja o bandeja honda	150	2	40 - 50
Tartaletas, 8 piezas	bandeja o bandeja honda	170	2	30 - 40
Verduras pochadas, 0,4 kg	bandeja o bandeja honda	180	2	35 - 45
Tortilla vegetariana	molde para pizza sobre parrilla	180	3	35 - 45
Verduras mediterráneas, 0,7 kg	bandeja o bandeja honda	180	4	35 - 45

## 11.8 Información para los institutos de pruebas

Pruebas conforme a IEC 60350-1.

				 (°C)	 (min)	
Pastelillos, 20 unidades por bandeja	Cocción convencional	Bandeja de cocción	3	170	20 - 30	-
Pastelillos, 20 unidades por bandeja	Aire caliente	Bandeja de cocción	3	150 - 160	20 - 35	-
Pastelillos, 20 unidades por bandeja	Aire caliente	Bandeja de cocción	2 y 4	150 - 160	20 - 35	-
Tarta de manzana, 2 moldes, Ø 20 cm	Cocción convencional	Parrilla	2	180	70 - 90	-
Tarta de manzana, 2 moldes, Ø 20 cm	Aire caliente	Parrilla	2	160	70 - 90	-
Bizcocho, molde de repostería Ø26 cm	Cocción convencional	Parrilla	2	170	40 - 50	Precaliente el horno 10 minutos.
Bizcocho, molde de repostería Ø26 cm	Aire caliente	Parrilla	2	160	40 - 50	Precaliente el horno 10 minutos.
Bizcocho, molde de repostería Ø26 cm	Aire caliente	Parrilla	2 y 4	160	40 - 60	Precaliente el horno 10 minutos.
Mantecados	Aire caliente	Bandeja de cocción	3	140 - 150	20 - 40	-
Mantecados	Aire caliente	Bandeja de cocción	2 y 4	140 - 150	25 - 45	-
Mantecados	Cocción convencional	Bandeja de cocción	3	140 - 150	25 - 45	-
Tostadas, 4 - 6 trozos	Grill	Parrilla	4	máx.	2 - 3 minutos el primer lado; 2 - 3 minutos el segundo	Precaliente el horno 3 minutos.
Hamburguesa de vacuno, 6 trozos, 0,6 kg	Grill	Parrilla y graserá	4	máx.	20 - 30	Coloque la parrilla en el cuarto nivel y la graserá en el tercer nivel del horno. Dele la vuelta a la mitad del tiempo. Precaliente el horno 3 minutos.

## 12. MANTENIMIENTO Y LIMPIEZA



### ADVERTENCIA!

Consulte los capítulos sobre seguridad.

### 12.1 Notas sobre la limpieza



Agentes limpiadores

Limpie la parte delantera del horno con un paño suave humedecido en agua templada y jabón suave. Limpie y compruebe la junta de la puerta alrededor del interior.

Utilice un producto de limpieza para limpiar las superficies metálicas.

Limpie las manchas con un detergente suave.



Uso diario

Limpie el interior después de cada uso. La acumulación de grasa u otros residuos puede provocar un incendio.

La humedad puede llegar a condensarse en el horno o en los paneles de cristal. Para reducir la condensación, ponga en funcionamiento el horno 10 minutos antes de cocinar. No guarde la comida en el horno más de 20 minutos. Seque el interior con un paño suave después de cada uso.



Accesorios

Limpie todos los accesorios después de cada uso y déjelos secar. Use un paño suave humedecido en agua caliente y detergente suave. No lave los accesorios en el lavavajillas

No limpie los accesorios no adherentes utilizando un limpiador abrasivo ni objetos afilados.

### 12.2 Cómo quitar: Apoyos de baldas

Para limpiar el horno, retire los carriles de apoyo.

**Paso 1** Apague el horno y espere a que esté frío.

**Paso 2** Tire de la parte delantera del carril de apoyo para separarlo de la pared lateral.

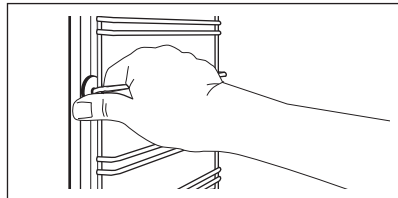



**Paso 3** Tire del extremo trasero del carril de apoyo para despegarlo de la pared lateral y sáquelo.

**Paso 4** Coloque los carriles apoyo en el orden inverso.

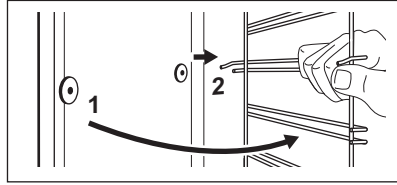

## 12.3 Cómo quitar e instalar: Puerta

La puerta del horno tiene tres paneles de cristal. Retire la puerta del horno y los paneles internos de cristal para limpiarlos. Lea las instrucciones completas de "Extracción e instalación de la puerta" antes de retirar los paneles de cristal.



### PRECAUCIÓN!

No utilice el aparato sin los paneles de cristal.

**Paso 1** Abra completamente la puerta y localice la bisagra del lado derecho de la puerta.

**Paso 2** Utilice un destornillador para levantar y girar completamente la palanca de la bisagra derecha.

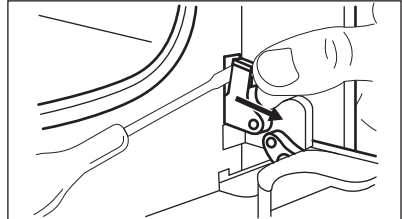

**Paso 3** Localice la bisagra del lado izquierdo de la puerta.

**Paso 4** Levante y gire completamente la palanca de la bisagra izquierda.

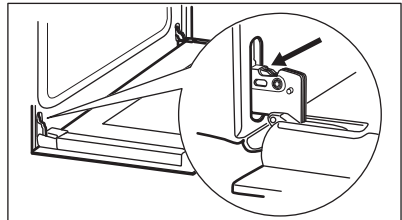

**Paso 5** Cierre la puerta del horno a medio camino hasta la primera posición de apertura. A continuación levante la puerta y tire hacia adelante para desengancharla.

**Paso 6** Coloque la puerta sobre una superficie estable y protegida por un paño suave.

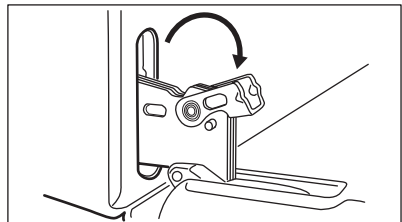

**Paso 7** Sujete por ambos lados el acabado de la puerta (B), situado en el borde superior de ésta, y empuje hacia dentro para soltar el sello de resorte.

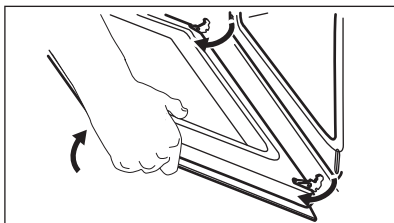

**Paso 8** Tire del borde de la puerta hacia delante para desengancharla.

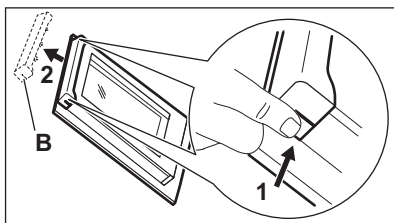

**Paso 9** Sujete los paneles de la puerta de cristal por el borde superior y extráigalos uno a uno con cuidado. Empiece por el panel superior. Asegúrese de que el cristal se desliza completamente fuera de los soportes.

**Paso 10** Limpie los paneles de cristal con agua y jabón. Seque los paneles de cristal con cuidado. No limpie los paneles de cristal en el lavavajillas.

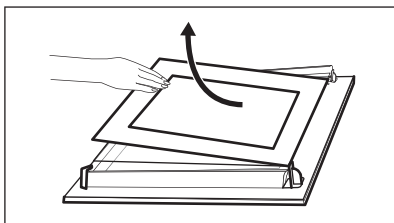

**Paso 11** Después de la limpieza, instale el panel de vidrio y la puerta del horno.

Asegúrese de que vuelve a colocar los paneles de cristal (A y B) en el orden correcto. Compruebe el símbolo/la ilustración del lado del panel de cristal, cada uno de los paneles de cristal es distinto para facilitar el montaje y desmontaje.

Al instalarlo correctamente, el acabado de la puerta hace clic.

Asegúrese de que coloca el panel de cristal central en los soportes correctamente.

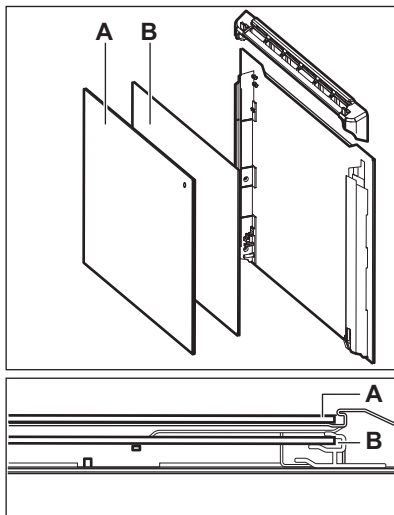

## 12.4 Cómo cambiar: Bombilla



### ADVERTENCIA!

Riesgo de descarga eléctrica.  
La lámpara puede estar caliente.

Coja siempre la bombilla halógena con un paño para evitar quemar los residuos de grasa.

### Antes de reemplazar la bombilla:

Paso 1	Paso 2	Paso 3
Apague el horno. Espere hasta que el horno esté frío.	Desconecte el horno de la red.	Coloque un paño en el fondo de la cavidad.

## Bombilla trasera

<b>Paso 1</b>	Gire la tapa de cristal para extraerla.
<b>Paso 2</b>	Limpie la tapa de cristal.
<b>Paso 3</b>	Cambie la bombilla por otra apropiada termorresistente hasta 300 °C.
<b>Paso 4</b>	Coloque la tapa de cristal.

## 13. SOLUCIÓN DE PROBLEMAS



### ADVERTENCIA!

Consulte los capítulos sobre seguridad.

### 13.1 Qué hacer si...

En cualquier caso no incluido en esta tabla, por favor contacte con un Centro de Servicio Autorizado.

Problema	Compruebe que...
El horno no calienta.	Ha saltado el fusible.
La junta de la puerta está dañada.	No utilice el horno. Póngase en contacto con un servicio técnico autorizado.
La pantalla muestra "12.00".	Ha habido un corte de alimentación. Ajusta el reloj.

Problema	Compruebe que...
La bombilla no funciona.	La bombilla se ha fundido.

### 13.2 Datos de servicio

Si no logra subsanar el problema, póngase en contacto con su distribuidor o el centro de servicio técnico.

Los datos que necesita para el centro de servicio técnico se encuentran en la placa de características. La placa de régimen se encuentra en el marco delantero de la cavidad del horno. No retire la placa de características de la cavidad del horno.

### Es conveniente que anote los datos aquí:

Modelo (MOD.)	.....
Número de producto (PNC)	.....
Número de serie (S.N.)	.....

## 14. EFICACIA ENERGÉTICA

### 14.1 Información del producto y Hoja de información del producto\*

Nombre del proveedor	AEG
Identificación del modelo	BEE431011M 949496317
Índice de eficiencia energética	95.3
Clase de eficiencia energética	A
Consumo de energía con carga estándar, modo convencional	0.93 kWh/ciclo
Consumo de energía con carga estándar, modo con ventilador	0.81 kWh/ciclo
Número de cavidades	1
Fuente de calor	Electricidad
Volumen	72 l
Tipo de horno	Horno empotrado
Masa	30.2 kg

\* Para la Unión Europea según los Reglamentos de la UE 65/2014 y 66/2014.

Para la República de Bielorrusia según STB 2478-2017, apéndice G; STB 2477-2017, anexos A y B.

Para Ucrania según 568/32020.

La clase de eficiencia energética no es aplicable a Rusia.

EN 60350-1 - Aparatos electrodomésticos - Parte 1: Placas, hornos, hornos de vapor y parrillas - Métodos para medir el rendimiento.

### 14.2 Ahorro de energía



El horno tiene características que le ayudan a ahorrar energía durante la cocina de cada día.

Asegúrese de que la puerta del horno está cerrada cuando el horno funciona. No abra la puerta del horno muchas veces durante la cocción. Mantenga limpia la junta de la puerta y asegúrese de que está bien fijada en su posición.

Utilice utensilios de cocina de metal para mejorar el ahorro energético.

En la medida de lo posible, no precaliente el horno antes de cocinar.

Reduzca al máximo el tiempo entre horneados cuando prepare varios platos de una vez.

#### **Cocción con ventilador**

En la medida de lo posible, utilice las funciones de cocción con ventilador para ahorrar energía.

#### **Calor residual**

Para una duración de la cocción superior a 30 minutos, reduzca la temperatura del horno un mínimo de 3 - 10 minutos antes de que transcurra el tiempo de cocción. El calor residual dentro del horno seguirá cocinando.

Utilice el calor residual para calentar otros platos.

#### **Mantener calor**

Si desea utilizar el calor residual para mantener calientes los alimentos, seleccione el ajuste de temperatura más bajo posible.

#### **Horneado húmedo + ventil.**

Función diseñada para ahorrar energía durante la cocción.

## 15. ASPECTOS MEDIOAMBIENTALES

Recicle los materiales con el símbolo . Coloque el material de embalaje en los contenedores adecuados para su reciclaje. Ayude a proteger el medio ambiente y la salud pública, así como a reciclar residuos de aparatos eléctricos y electrónicos. No

deseche los aparatos marcados con el símbolo  junto con los residuos domésticos. Lleve el producto a su centro de reciclaje local o póngase en contacto con su oficina municipal.

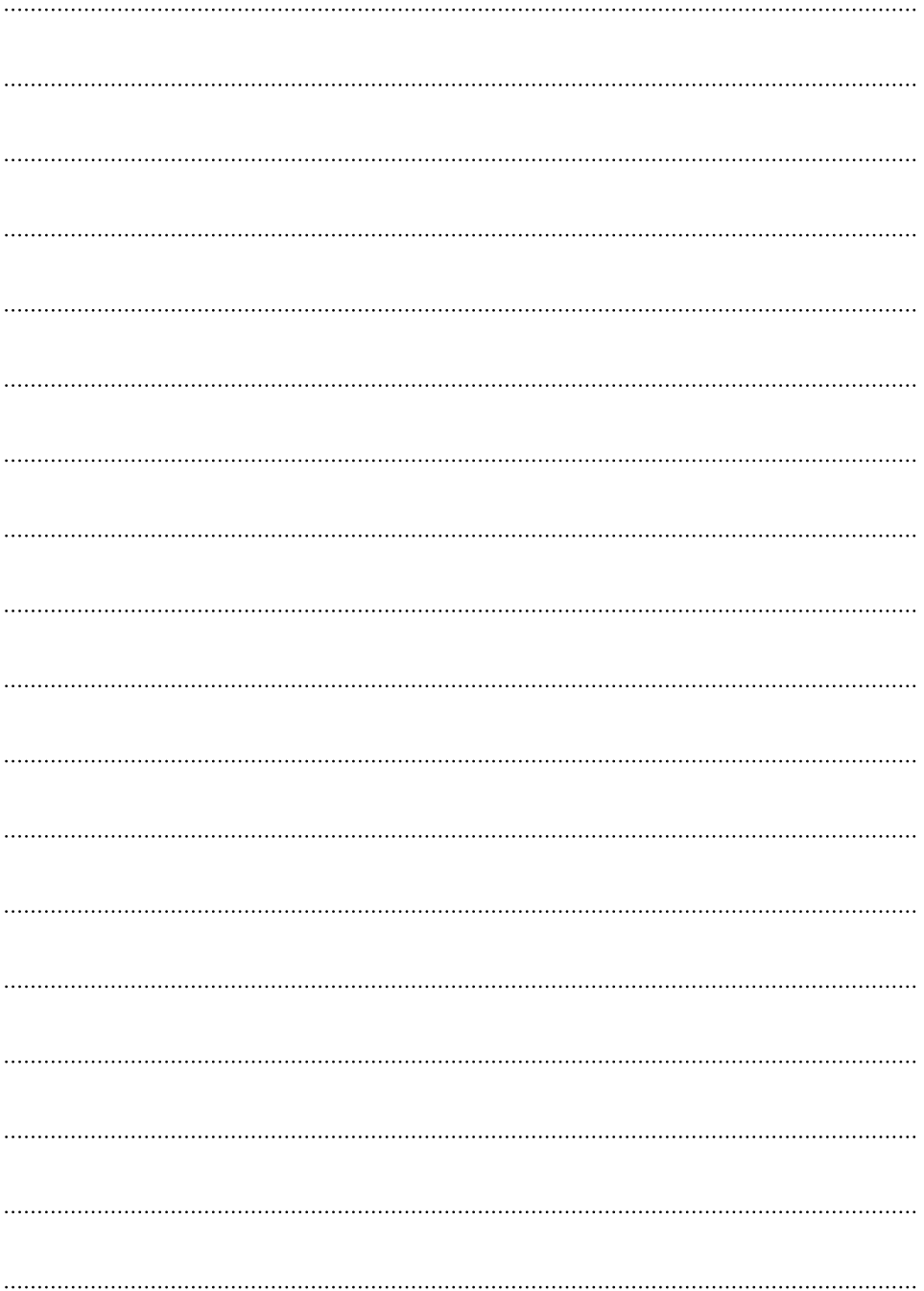

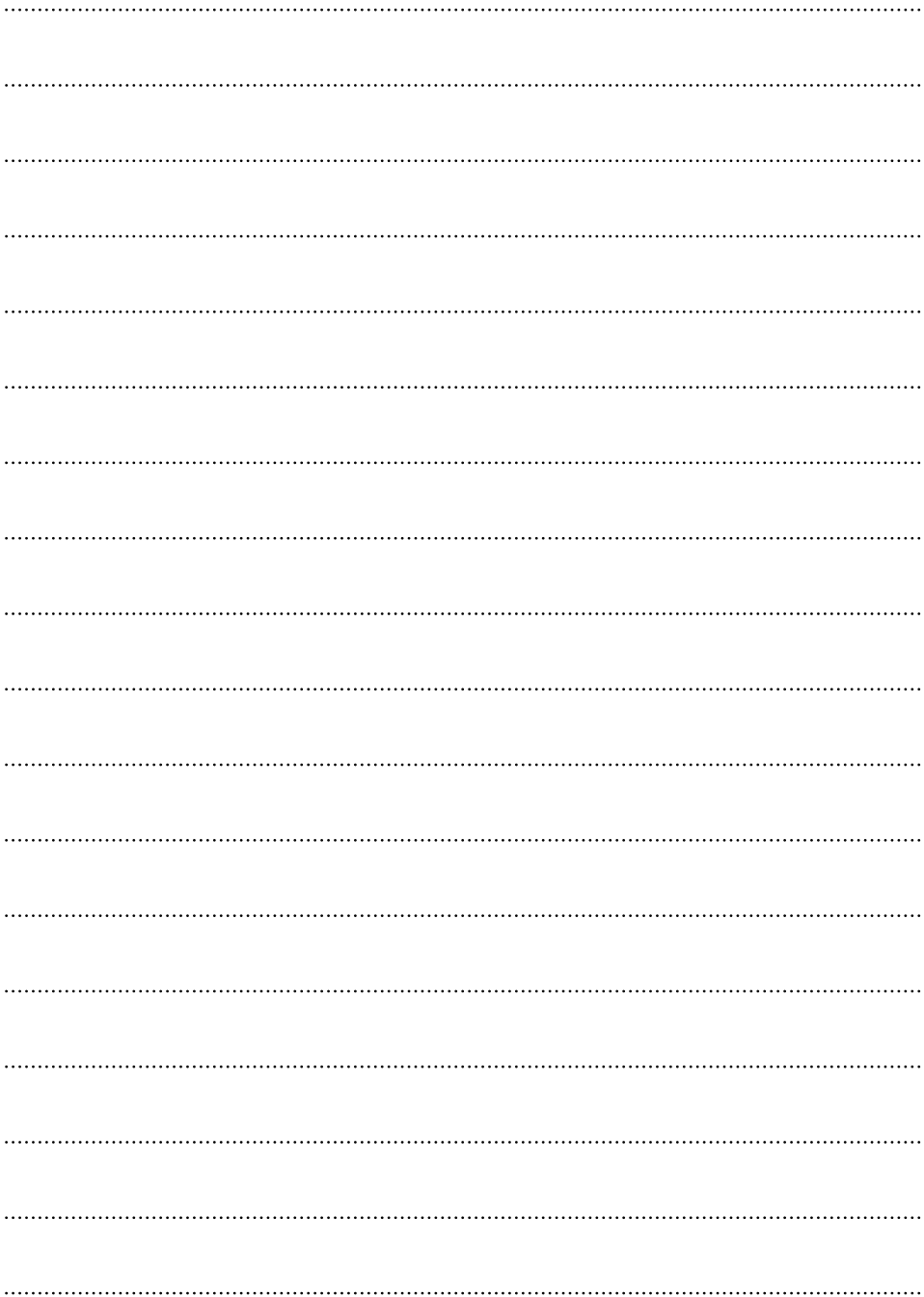

[www.aeg.com/shop](http://www.aeg.com/shop)



867360231-A-032021



**AEG**