

ASUS

RT-AX53U

**Wireless-AX1800 Dual Band
WiFi 6 Router**



Quick Start Guide

A17979 / First Edition / April 2021



Table of contents

Package contents	3
A quick look at RT-AX53U	3
Positioning your wireless router	4
Preparing your modem	5
Setting up your RT-AX53U	6
You can set up your router via wired or wireless connection.	6
FAQ	8
Networks Global Hotline Information.....	43

This QSG contains these languages:

English, 繁體中文, Bahasa Indonesia, Bahasa Melayu, ไทย,
Tiếng Việt



Package contents

- RT-AX53U Wireless Router
- AC adapter
- Network cable (RJ-45)
- Quick Start Guide

English

A quick look at RT-AX53U

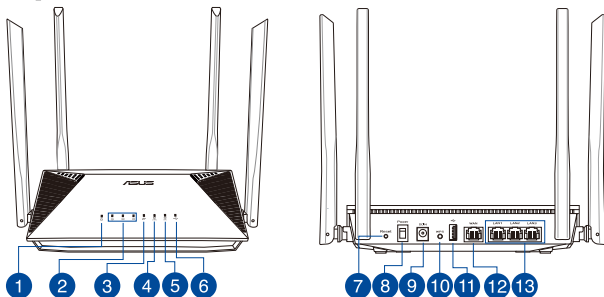

1 Power LED	8 Power switch
2 LAN 1~3 LEDs	9 Power (DCIN) port
3 WAN (Internet) LED	10 WPS button
4 2.4GHz LED	11 USB 2.0 port
5 5GHz LED	12 WAN (Internet) port
6 USB 2.0 LED	13 LAN 1 ~ 4 ports
7 Reset button	

Positioning your wireless router

For optimal wireless transmission between the wireless router and connected wireless devices, ensure that you:

- Place the wireless router in a centralized area for a maximum wireless coverage for the network devices.
- Keep the wireless router away from metal obstructions and away from direct sunlight.
- Keep the wireless router away from 802.11g or 20MHz only Wi-Fi devices, 2.4GHz computer peripherals, Bluetooth devices, cordless phones, transformers, heavy-duty motors, fluorescent lights, microwave ovens, refrigerators, and other industrial equipment to prevent signal interference or loss.
- Always update to the latest firmware. Visit the ASUS website at <http://www.asus.com> to get the latest firmware updates.
- To ensure the best wireless signal, orient the four non-detachable antennas as shown in the drawing below.

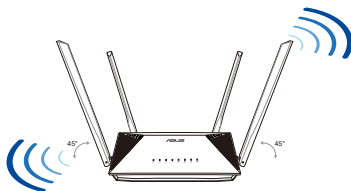

NOTES:

- Use only the adapter that came with your package. Using other adapters may damage the device.
- **Specifications:**

DC Power adapter	DC Output: +12V with 1.5A current		
Operating Temperature	0~40°C	Storage	0~70°C
Operating Humidity	50~90%	Storage	20~90%

Preparing your modem

1. **Unplug the power cable/DSL modem. If it has a battery backup, remove the battery.**

NOTE: If you are using DSL for Internet, you will need your username/ password from your Internet Service Provider (ISP) to properly configure the router.

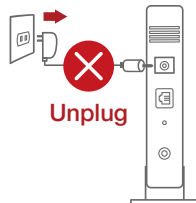

English

2. **Connect your modem to the router with the bundled network cable.**

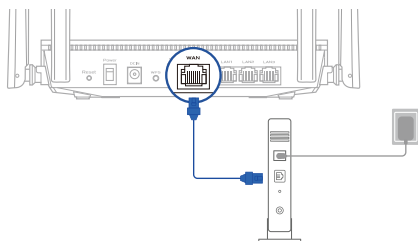

3. **Power on your cable/DSL modem.**
4. **Check your cable/DSL modem LED lights to ensure the connection is active.**

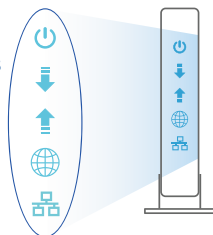

Setting up your RT-AX53U

You can set up your router via wired or wireless connection.

A. Wired connection

1. Plug your router into a power outlet and power it on. Connect the network cable from your computer to a LAN port on your router.

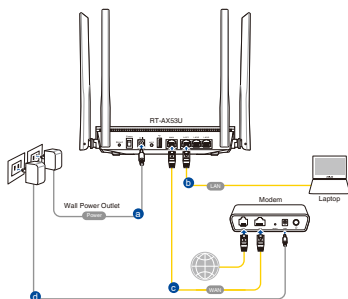

2. The web GUI launches automatically when you open a web browser. If it does not auto-launch, enter <http://router.asus.com>.
3. Set up a password for your router to prevent unauthorized access.

Login Information Setup

Change the router password to prevent unauthorized access to your ASUS wireless router.

Router Login Name	<input type="text" value="admin"/>
New Password	<input type="password"/>
Retype Password	<input type="password"/> <input type="checkbox"/> Show password

B. Wireless connection

1. Plug your router into a power outlet and power it on.

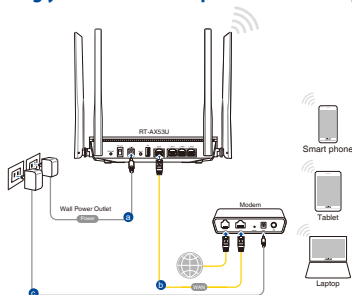

2. Connect to the network with SSID shown on the product label on the bottom side of the router. For better network security, change to a unique SSID and assign a password.



Wi-Fi Name (SSID):

ASUS_XX

- * **XX** refers to the last two digits of the MAC address. You can find it on the label on the bottom of your router.

3. You can choose either the web GUI or ASUS Router app to set up your router.

a. Web GUI Setup

- Once connected, the web GUI launches automatically when you open a web browser. If it does not auto-launch, enter <http://router.asus.com>.
- Set up a password for your router to prevent unauthorized access.

Login Information Setup

Change the router password to prevent unauthorized access to your ASUS wireless router.

Router Login Name

New Password

Retype Password Show password

b. App Setup

Download ASUS Router App to set up your router via your mobile devices.

- Turn on Wi-Fi on your mobile devices and connect to your router's network.
- Follow ASUS Router App setup instructions to complete the setup.



ASUS Router



GET IT ON
Google Play



Download on the
App Store

Q | ASUS Router

Remembering your wireless router settings

- Remember your wireless settings as you complete the router setup.

Router Name:	Password:
2.4 GHz network SSID:	Password:
5GHz network SSID:	Password:

FAQ

Where can I find more information about the wireless router?

- Technical support site: <https://www.asus.com/support>
- You can get the user manual online at <https://www.asus.com/support>



產品包裝內容

- ☑ RT-AX53U 無線路由器
- ☑ 電源變壓器
- ☑ RJ-45 網路線
- ☑ 快速使用指南

認識您的無線路由器

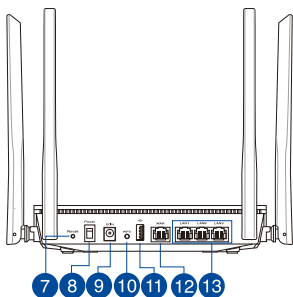
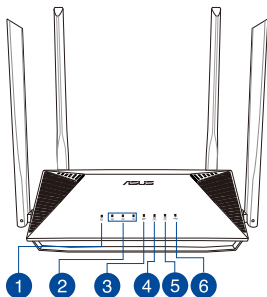

1 電源指示燈	8 電源開關
2 LAN 1~3 指示燈	9 電源 (DCIN) 連接埠
3 WAN (網際網路) 指示燈	10 WPS 按鈕
4 2.4GHz 指示燈	11 USB 2.0 連接埠
5 5GHz 指示燈	12 WAN (網際網路) 連接埠
6 USB 2.0 指示燈	13 LAN 1 ~ 4 網路連接埠
7 重置按鈕	

放置您的路由器

為獲得無線路由器與所連線的網路裝置之間傳送最佳無線訊號，請確認以下幾點：

- 建議將路由器放置在中心區域，以獲得最佳無線訊號覆蓋範圍。
- 請勿將裝置放在靠近金屬物品與陽光直射的地方。
- 請遠離其它 802.11g 或 20MHz Wi-Fi 裝置、2.4GHz 電腦周邊裝置、藍牙裝置、無線室內電話、傳送器、重型發動機、日光燈、微波爐、電冰箱與其他工業裝置，以防止訊號干擾或減損。
- 請經常更新至最新版本韌體。您可以登入華碩官網 <https://www.asus.com/tw/> 獲得最新韌體。
- 請依據下圖所示擺放路由器上的四根非可拆式天線以獲得最佳無線訊號覆蓋範圍。

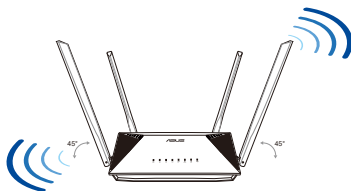

注意：

- 請僅使用包裝中的電源變壓器。使用其他類型的電源變壓器可能會造成裝置損毀。
- 規格：

直流電源變壓器	DC 輸出：+12V，最大電流 1.5A		
運作溫度	0~40° C	儲存溫度	0~70° C
運作濕度	50~90%	儲存濕度	20~90%

準備數據機

1. 拔除您的電纜 / DSL 數據機電源，若數據機內含備用電池，請移除電池。

注意：若您使用 DSL 連線網際網路，需要向您的網路服務供應商（ISP）取得登入名稱 / 密碼，以正確設定您的無線路由器。

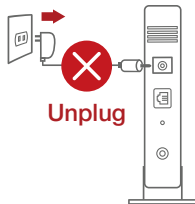

2. 使用隨附的網路線連接您的數據機與無線路由器。

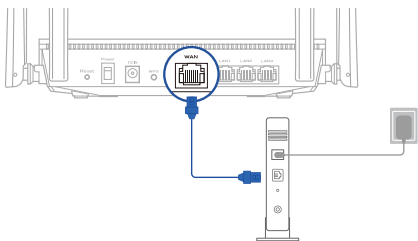

3. 開啟您的纜線 / DSL 數據機。
4. 查看數據機的 LED 指示燈以確認連線是否已準備就緒。

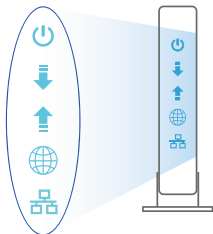

設定您的無線路由器

您可以透過有線或無線兩種方式設定您的無線路由器。

A. 有線連線

1. 將您的無線路由器與電源相連並開機。用網路線將您的電腦與無線路由器的 LAN 連接埠相連。

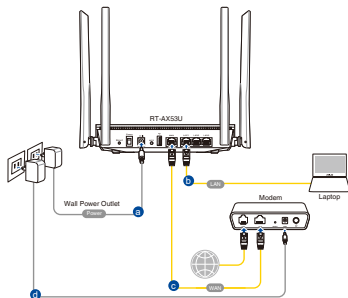

2. 當您開啟網頁瀏覽器時，網頁設定介面會自動出現。若沒有出現，請在網址欄中輸入 <http://router.asus.com>。
3. 為無線路由器設定密碼以阻止未經授權的存取。

Login Information Setup

Change the router password to prevent unauthorized access to your ASUS wireless router.

Router Login Name	<input type="text" value="admin"/>
New Password	<input type="password"/>
Retype Password	<input type="password"/> <input type="checkbox"/> Show password

B. 無線連線

- 將您的無線路由器與電源相連並開機。

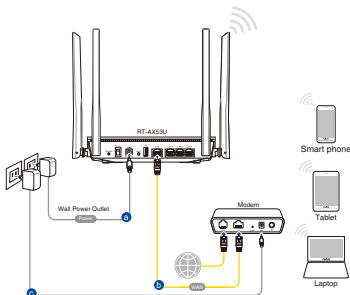

- 連線到無線路由器底部標籤上註明的網路名稱 (SSID)。為確保最佳的網路安全性，請更改預設的 SSID 和密碼。



Wi-Fi 名稱 (SSID) :

ASUS_XX

- * XX 代表 2.4GHz MAC 位址的最後兩位數，您可以在路由器底部的貼紙上找到。

- 您可以在網頁瀏覽器或 **ASUSRouterApp** 中設定您的路由器。

a. 透過網頁瀏覽器設定

- 連線網路後，當您開啟網頁瀏覽器時，網頁設定介面會自動出現。若沒有出現，請在網址欄中輸入 <http://router.asus.com>。
- 為無線路由器設定密碼以阻止未經授權的存取。

Login Information Setup

Change the router password to prevent unauthorized access to your ASUS wireless router.

Router Login Name

New Password

Retype Password Show password

b. 透過 App 設定

透過行動裝置下載 **ASUS Router App** 以設定您的路由器。

- 開啟行動裝置的 **Wi-Fi** 並連線至無線路由器的網路。
- 遵照 **ASUS Router App** 設定嚮導完成路由器設定。



ASUS
Router



Q | ASUS Router

記住無線路由器的設定

- 完成無線路由器的設定後，請記住您的無線設定。

路由器登入名稱：	密碼：
2.4GHz 網路 SSID：	密碼：
5GHz 網路 SSID：	密碼：

FAQ

哪裡可以找到更多的無線路由器資訊？

- 技術支援網址：<https://www.asus.com/tw/support>
- 您可至 <https://www.asus.com/tw/support> 下載使用手冊

Isi kemasan

- Router Nirkabel RT-AX53U
- Kabel jaringan (RJ-45)
- Adaptor AC
- Panduan Ringkas

Tampilan RT-AX53U

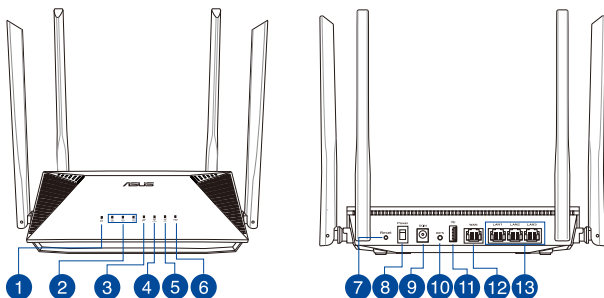

1 LED Daya	8 Tombol daya
2 LEDs LAN 1~3	9 Port daya (DC-IN)
3 LED WAN (Internet)	10 Tombol WPS
4 LED 2,4GHz	11 Port USB 2.0
5 LED 5GHz	12 Port WAN (Internet)
6 LED USB 2.0	13 Port LAN 1~3
7 Tombol atur ulang	

Mengatur posisi router nirkabel Anda

Untuk transmisi sinyal nirkabel terbaik antara router nirkabel dan perangkat jaringan yang tersambung, pastikan Anda:

- Menempatkan router nirkabel di area tengah agar jangkauan nirkabel maksimum untuk perangkat jaringan.
- Tidak menghalangi perangkat dengan benda logam dan menjauhkan dari sinar matahari langsung.
- Menjauhkan perangkat dari perangkat Wi-Fi 802.11g atau hanya 20 MHz, periferal komputer 2,4 GHz, perangkat Bluetooth, telepon nirkabel, trafo, mesin berat, cahaya neon, oven microwave, lemari es, dan peralatan industri lainnya untuk mencegah interferensi atau hilangnya sinyal.
- Selalu memperbarui ke firmware terkini. Untuk mendapatkan pembaruan firmware terkini, kunjungi situs Web ASUS <http://www.asus.com>.
- Untuk memastikan sinyal nirkabel terbaik, arahkan empat antena yang tidak dapat dilepas seperti yang ditunjukkan gambar di bawah.

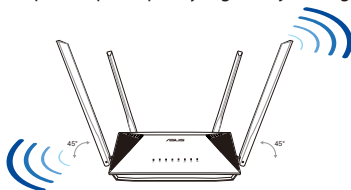

CATATAN:

- Gunakan hanya adaptor yang diberikan dalam paket. Menggunakan adaptor lain dapat merusak perangkat.
- **Spesifikasi:**

Adaptor daya DC	Output DC: +12 V dengan arus maks. 1.5 A		
Suhu Pengoperasian	0~40°C	Penyimpanan	0~70°C
Kelembaban Pengoperasian	50~90%	Penyimpanan	20~90%

Menyiapkan modem

1. Lepaskan modem DSL/kabel dari catu daya. Jika ada cadangan baterai, keluarkan baterai.

CATATAN: Jika menggunakan DSL untuk Internet, Anda memerlukan nama pengguna/sandi dari Penyedia Layanan Internet (ISP) untuk mengkonfigurasi router dengan benar.

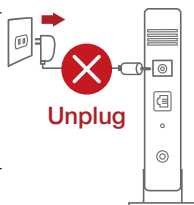

Bahasa Indonesia

2. Sambungkan modem ke router dengan kabel jaringan yang tersedia.

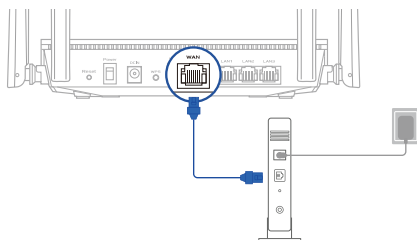

3. Hidupkan modem kabel/DSL.
4. Periksa lampu LED modem kabel/DSL untuk memastikan sambungan sudah aktif.

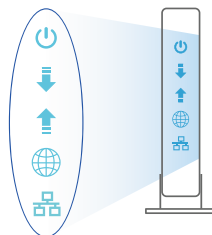

Mengkonfigurasi RT-AX53U

Anda dapat mengkonfigurasi router melalui sambungan berkabel atau nirkabel.

A. Sambungan berkabel

1. Sambungkan router ke stopkontak dan hidupkan. Sambungkan kabel jaringan dari komputer ke port LAN pada router.

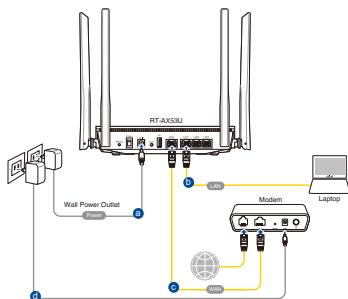

2. GUI web akan secara otomatis dijalankan saat Anda membuka browser web. Jika tidak secara otomatis dijalankan, buka <http://router.asus.com>.
3. Konfigurasi sandi router untuk mencegah akses yang tidak sah.

Login Information Setup

Change the router password to prevent unauthorized access to your ASUS wireless router.

Router Login Name	<input type="text" value="admin"/>
New Password	<input type="password"/>
Retype Password	<input type="password"/> <input type="checkbox"/> Show password

B. Sambungan Nirkabel

1. Sambungkan router ke stopkontak dan hidupkan.

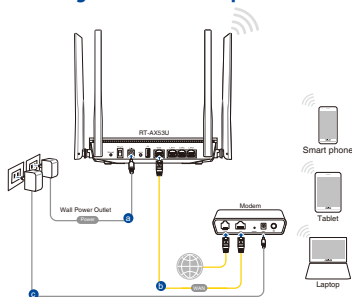

2. Sambungkan ke nama jaringan (SSID) yang tertera pada label produk, di bagian bawah router. Untuk keamanan jaringan yang lebih baik, ubah menjadi SSID unik, lalu tetapkan sandi.



Nama Wi-Fi (SSID): ASUS_XX

- * **XX** mengacu ke 2 angka terakhir pada alamat MAC. Anda dapat menemukannya pada label di bagian bawah RT-AX53U.

3. Anda dapat memilih aplikasi GUI web atau ASUS Router untuk mengatur router.

a. Konfigurasi GUI Web

- GUI web akan secara otomatis dijalankan saat Anda membuka browser web. Jika tidak secara otomatis dijalankan, buka <http://router.asus.com>.
- Konfigurasikan sandi router untuk mencegah akses yang tidak sah.

Login Information Setup

Change the router password to prevent unauthorized access to your ASUS wireless router.

Router Login Name

New Password

Retype Password Show password

b. Konfigurasi Aplikasi

Untuk mengkonfigurasi router melalui perangkat bergerak, download Aplikasi ASUS Router.

- Aktifkan Wi-Fi di perangkat bergerak, lalu sambungkan ke jaringan RT-AX53U.
- Ikuti petunjuk pada Aplikasi ASUS Router untuk menyelesaikan konfigurasi.



ASUS Router



ASUS Router

Menyimpan pengaturan router nirkabel

- Ingat pengaturan nirkabel setelah Anda menyelesaikan konfigurasi router.

Nama Router:	Sandi:
SSID jaringan 2,4 GHz:	Sandi:
SSID jaringan 5 GHz:	Sandi:

Tanya Jawab

1. Di mana saya dapat memperoleh informasi lengkap tentang router nirkabel?
 - Situs Dukungan Teknis: <https://www.asus.com/support>
 - Anda dapat memperoleh panduan pengguna secara online di <https://www.asus.com/support>

Kandungan pembungkusan

- ✓ Penghala wayarles RT-AX53U
- ✓ Penyesuai AU
- ✓ Kabel rangkaian (RJ-45)
- ✓ Panduan Mula Ringkas

Melihat sepintas Lalu RT-AX53U anda

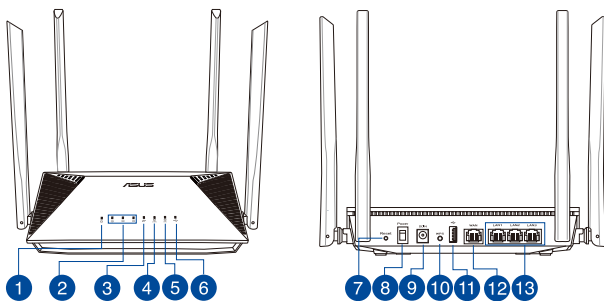

1 LED Kuasa	8 Suis kuasa
2 Port LAN 1~3	9 Port kuasa (DC-In) (AT-Masuk)
3 WAN (Internet) LED	10 Butang WPS
4 LED 2,4GHz	11 Port USB 2.0
5 LED 5GHz	12 Port WAN (Internet)
6 LED USB 2.0	13 Port LAN 1~4
7 Butang tetapkan semula	

Meletakkan penghala wayarles anda

Untuk penghantaran wayarles optimum antara penghala wayarles dan peranti wayarles yang bersambung, pastikan anda:

- Letakkan penghala wayarles dalam kawasan terpusat untuk liputan wayarles maksimum untuk peranti rangkaian.
- Pastikan penghala wayarles jauh daripada penghalang logam dan jauh daripada cahaya matahari langsung.
- Pastikan penghala wayarles jauh daripada peranti Wi-Fi 802.11g atau 20MHz sahaja, 2,4GHZ persisian komputer, peranti Bluetooth, telefon kordles, pengubah, motor tugas berat, lampu kalimantang, ketuhar gelombang mikro, peti sejuk, dan peralatan industri lain untuk mengelakkan gangguan atau kehilangan isyarat.
- Sentiasa kemas kini persisian tegar terkini. Lawati tapak web ASUS di <http://www.asus.com> untuk mendapatkan kemas kini persisian tegar terkini.
- Untuk memastikan isyarat wayarles terbaik, sesuaikan 4 antena tidak boleh tanggal seperti yang ditunjukkan dalam rajah di bawah.

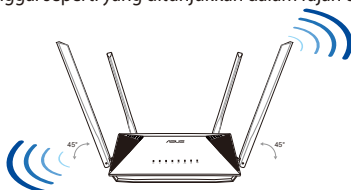

NOTA:

- Hanya guna adapter yang disertakan bersama pakej anda. Menggunakan adapter lain boleh merosakkan peranti.
- **Spesifikasi:**

Adapter Kuasa DC	Output DC: +12V dengan arus maksimum 1.5A		
Suhu Pengendalian	0~40°C	Penyimpanan	0~70°C
Kelembapan Operasi	50~90%	Penyimpanan	20~90%

Menyediakan modem anda

1. Cabut palam kabel kuasa/modem DSL. Jika ia mempunyai sandaran bateri, keluarkan bateri.

NOTA: Jika anda menggunakan DSL untuk Internet, anda akan memerlukan nama pengguna/kata laluan anda daripada Pembekal Perkhidmatan Internet (ISP) anda untuk mengkonfigurasi penghala dengan betul.

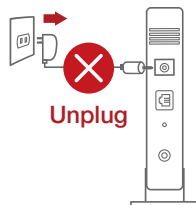

Bahasa Malaysia

2. Sambung modem anda ke penghala dengan kabel rangkaian yang digabungkan.

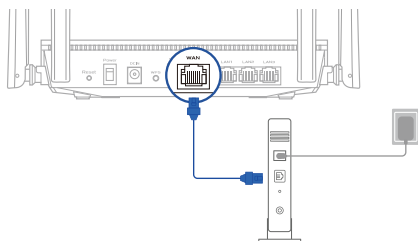

3. Hidupkan kuasa kabel/modem DSL anda.
4. Semak kabel/lampu LED modem DSL anda untuk memastikan sambungan adalah aktif.

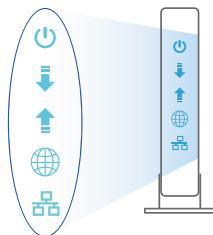

Menyediakan RT-AX53U anda

Anda boleh menyediakan penghala anda melalui sambungan berwayar atau wayarles.

A. Sambungan berwayar

1. Pasang masuk penghala anda ke sumber kuasa dan hidupkan kuasanya. Sambungkan kabel rangkaian dari komputer anda ke port LAN pada penghala anda.

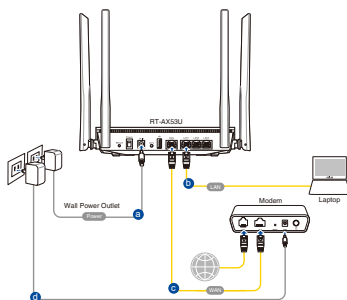

2. GUI web dilancarkan secara automatik apabila anda membuka pelayar web. Jika ia tidak melakukan pelancaran auto, masuki <http://router.asus.com>.
3. Sediakan kata laluan untuk penghala anda bagi menghalang akses yang tidak dibenarkan.

Login Information Setup

Change the router password to prevent unauthorized access to your ASUS wireless router.

Router Login Name	<input type="text" value="admin"/>
New Password	<input type="password"/>
Retype Password	<input type="password"/> <input type="checkbox"/> Show password

B. Sambungan wayarles

1. Pasang masuk penghala anda ke sumber kuasa dan hidupkan kuasanya.

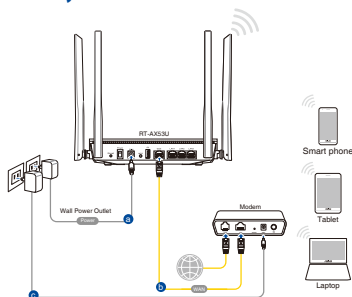

2. Sambung ke nama rangkaian (SSID) yang ditunjukkan pada label produk di bahagian sebelah bawah penghala. Untuk keselamatan rangkaian yang lebih baik, ubah ke SSID unik dan berikan kata laluan.

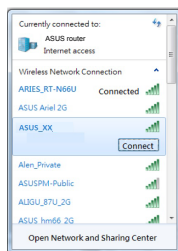

Nama Wi-Fi (SSID):

ASUS_XX

- * **XX** merujuk pada dua digit terakhir alamat MAC Anda boleh menemuinya pada label di sebelah bawah penghala anda.

3. Anda boleh memilih sama ada GUI web atau aplikasi Penghala ASUS untuk menyediakan penghala anda.

a. Penyediaan GUI Web

- GUI web dilancarkan secara automatik apabila anda membuka pelayar web. Jika ia tidak melakukan pelancaran auto, masuki <http://router.asus.com>.
- Sediakan kata laluan untuk penghala anda bagi menghalang akses yang tidak dibenarkan.

Login Information Setup

Change the router password to prevent unauthorized access to your ASUS wireless router.

Router Login Name

New Password

Retype Password Show password

b. Penyediaan Aplikasi

Muat turun Aplikasi Penghala ASUS untuk menyediakan penghala anda melalui peranti mudah alih anda.

- **Hidupkan Wi-Fi pada peranti mudah alih anda dan sambung ke rangkaian Penghala ASUS anda.**
- **Ikuti arahan penyediaan Aplikasi Penghala ASUS untuk melengkapkan penyediaan.**



ASUS Router



Q ASUS Router

Mengingati tetapan penghala wayarles anda

- **Ingat tetapan wayarles anda apabila anda melengkapkan penyediaan penghala.**

Nama Penghala:	Kata Laluan:
SSID rangkaian 2.4GHz:	Kata Laluan:
SSID rangkaian 5GHz:	Kata Laluan:

Soalan Lazim (FAQ)

1. Di manakah saya boleh mendapatkan maklumat lanjut mengenai penghala tanpa wayar?
 - Tapak Sokongan Teknikal: <https://www.asus.com/support>
 - Anda boleh mendapatkan manual pengguna dalam talian di <https://www.asus.com/support>

สิ่งต่างๆ ในกล่องบรรจุ

- ✓ RT-AX53U ไร้สาย เราเตอร์
- ✓ อะแดปเตอร์ AC
- ✓ สายเคเบิลเครือข่าย (RJ-45)
- ✓ คู่มือเริ่มต้นฉบับย่อ

ไทย

ดูที่ RT-AX53U ของคุณอย่างรวดเร็ว

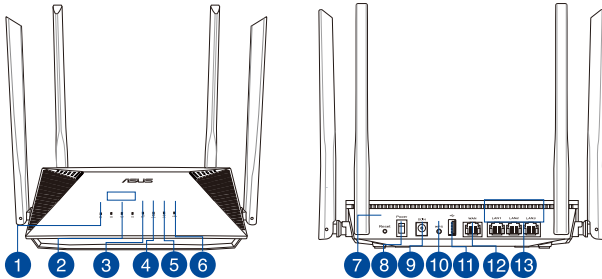

1 LED เพาเวอร์	8 สวิตช์พาวเวอร์
2 พอร์ต LAN 1~3	9 พอร์ตเพาเวอร์ (DCเข้า)
3 LED WAN (อินเทอร์เน็ต)	10 ปุ่ม WPS
4 LED 2.4GHz	11 พอร์ต USB 2.0
5 LED 5GHz	12 พอร์ต WAN (อินเทอร์เน็ต)
6 LED USB 2.0	13 พอร์ต LAN 1~3
7 ปุ่มรีเซ็ต	

การวางตำแหน่งไวร์เลส เราเตอร์ของคุณ

เพื่อให้การรับส่งสัญญาณไร้สายระหว่างไวร์เลสเราเตอร์ และอุปกรณ์เครือข่าย ที่เชื่อมต่ออยู่มีคุณภาพที่ดีที่สุด ให้แน่ใจว่าคุณ:

- วางไวร์เลสเราเตอร์ในบริเวณศูนย์กลาง เพื่อให้ครอบคลุมพื้นที่ไร้สายมากที่สุดสำหรับอุปกรณ์เครือข่าย
- วางอุปกรณ์ให้ห่างจากวัตถุวางกันที่เป็นโลหะ และไม่ให้อุปกรณ์ถูกแสงแดดโดยตรง
- วางอุปกรณ์ให้ห่างจากอุปกรณ์ Wi-Fi 802.11g หรือ 20MHz, อุปกรณ์คอมพิวเตอร์ 2.4GHz, อุปกรณ์บลูทูธ, โทรศัพท์ไร้สาย, หม้อแปลง, มอเตอร์พลังงานสูง, แสงฟลูออเรสเซนต์, เตาไมโครเวฟ, ตู้เย็น และอุปกรณ์อุตสาหกรรมอื่นๆ เพื่อป้องกันสัญญาณรบกวน หรือสัญญาณสูญหาย
- อัปเดตเฟิร์มแวร์ล่าสุดเสมอ เยี่ยมชมเว็บไซต์ ASUS ที่ <http://www.asus.com> เพื่อรับอัปเดตเฟิร์มแวร์ล่าสุด
- เพื่อให้มั่นใจถึงสัญญาณไร้สายที่ดีที่สุด ให้ปรับทิศทางเสาอากาศที่สามารถ ถอดได้ 4 อัน ในลักษณะที่แสดงในภาพด้านล่าง

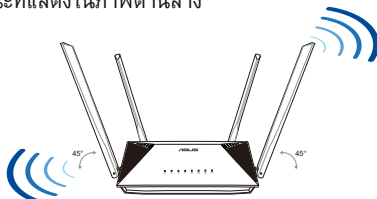

หมายเหตุ

- ใช้เฉพาะอะแดปเตอร์ที่มาพร้อมกับแพ็คเกจของคุณเท่านั้น การใช้อะแดปเตอร์อื่นอาจทำให้อุปกรณ์เสียหาย
- ข้อมูลจำเพาะ:

อะแดปเตอร์เพาเวอร์ DC	เอาต์พุต DC: +12V โดยมีกระแสสูงสุด 1.5A		
อุณหภูมิขณะทำงาน	0~40°C	ขณะเก็บรักษา	0~70°C
ความชื้นขณะทำงาน	50~90%	ขณะเก็บรักษา	20~90%

การเตรียมโมเด็มของคุณ

1. ถอดสายไฟ/โมเด็ม DSL หากมีแบตเตอรี่สำรอง
ให้ถอดแบตเตอรี่ออก

หมายเหตุ: หากคุณใช้ DSL
สำหรับ อินเทอร์เน็ต คุณต้องมีชื่อ
ผู้ใช้/รหัสผ่านจากผู้ให้บริการ
อินเทอร์เน็ต (ISP) เพื่อกำหนดค่า
เราเตอร์ อย่างถูกต้อง

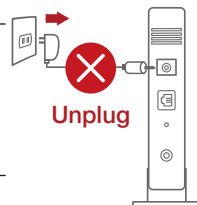

2. เชื่อมต่อโมเด็มของคุณเข้ากับเราเตอร์ด้วยสายเคเบิล เครือข่ายที่
ใหม่

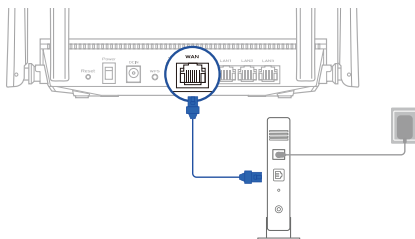

3. เปิดเคเบิล/โมเด็ม DSL
4. ตรวจสอบไฟ LED ของเคเบิล/โมเด็ม
DSL เพื่อให้แน่ใจว่าการเชื่อมต่อทำงาน
อยู่

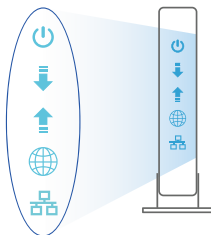

การตั้งค่า RT-AX53U

คุณสามารถตั้งค่าเราเตอร์ ผ่านการเชื่อมต่อแบบมีสาย หรือไร้สาย:

A. การเชื่อมต่อแบบมีสาย:

- เสียบเราเตอร์เข้ากับเต้าเสียบและ เปิดเครื่อง เชื่อมต่อสายเคเบิลเครือข่ายจากคอมพิวเตอร์ไปยัง พอร์ต LAN บนเราเตอร์ของคุณ

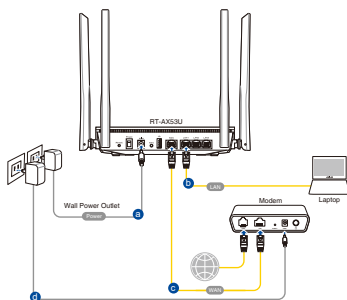

- เว็บ GUI จะเปิดใช้งานโดยอัตโนมัติเมื่อคุณเปิดเว็บเบราว์เซอร์ หากไม่เปิดใช้งานโดย อัตโนมัติ เข้าไปที่ <http://router.asus.com>
- ตั้งค่ารหัสผ่านสำหรับเราเตอร์ของคุณเพื่อความปลอดภัยจากการเข้าถึงที่ไม่ได้รับ อนุญาต

Login Information Setup

Change the router password to prevent unauthorized access to your ASUS wireless router.

Router Login Name	<input type="text" value="admin"/>	
New Password	<input type="password"/>	
Retype Password	<input type="password"/>	<input type="checkbox"/> Show password

B. การเชื่อมต่อไร้สาย

1. เสียบเราเตอร์เข้ากับเต้าเสียบและ เปิดเครื่อง

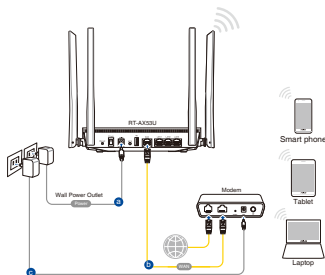

2. เชื่อมต่อกับชื่อเครือข่าย (SSID) ที่แสดงบนฉลากผลิตภัณฑ์ที่ด้านล่างของเราเตอร์ เพื่อการรักษาความปลอดภัยของเครือข่ายที่ดีกว่า เปลี่ยนเป็น SSID ที่มีลักษณะเฉพาะและกำหนดรหัสผ่าน



ชื่อ Wi-Fi (SSID):	ASUS_XX
--------------------	---------

- * **XX** หมายถึงตัวเลขสองหลักสุดท้ายของ MAC แอดเดรส คุณสามารถค้นหาได้บนฉลากด้านล่างของ RT-AX53U

3. คุณสามารถเลือกเว็บ GUI หรือแอป ASUS Router เพื่อตั้งค่าเราเตอร์ของคุณ

a. ตั้งค่าผ่านเว็บ GUI

- เมื่อเชื่อมต่อแล้ว เว็บ GUI จะเปิดใช้งานโดยอัตโนมัติเมื่อคุณเปิดเว็บเบราว์เซอร์ หากไม่เปิดใช้งานโดยอัตโนมัติ เข้าไปที่ <http://router.asus.com>
- ตั้งการรหัสผ่านสำหรับเราเตอร์ของคุณเพื่อความปลอดภัยจากการเข้าถึงที่ไม่ได้รับอนุญาต

Login Information Setup

Change the router password to prevent unauthorized access to your ASUS wireless router.

Router Login Name:

New Password:

Retype Password: Show password

b. ตั้งค่าผ่านแอป

ดาวน์โหลดแอป ASUS Router เพื่อตั้งค่าเราเตอร์ผ่านอุปกรณ์เคลื่อนที่

- เปิด Wi-Fi บนอุปกรณ์เคลื่อนที่ของคุณและเชื่อมต่อกับเครือข่ายของ RT-AX53U

- ปฏิบัติตามคำแนะนำการตั้งค่าแอป ASUS Router เพื่อทำการตั้งค่าให้สมบูรณ์



ASUS Router

Q ASUS Router

การจดจำการตั้งค่าเราเตอร์ไร้สาย

- จดจำการตั้งค่าไร้สายของคุณเมื่อคุณเสร็จสิ้นการตั้งค่าเราเตอร์

ชื่อเราเตอร์:	รหัสผ่าน:
SSID ของเครือข่าย 2.4 GHz:	รหัสผ่าน:
SSID ของเครือข่าย 5G Hz:	รหัสผ่าน:

คำถามที่ถามบ่อย

- สามารถหาข้อมูลเพิ่มเติมเกี่ยวกับเราเตอร์แบบไร้สายได้จากที่ไหน?
 - ใช้ดิสก์สนับสนุนด้านเทคนิค: <https://www.asus.com/support>
 - คุณสามารถขอรับคู่มือผู้ใช้ออนไลน์ได้ที่ <https://www.asus.com/support>

Hàng hóa đóng gói

- Router không dây RT-AX53U
- Adapter AC (điện xoay chiều)
- Cáp mạng (RJ-45)
- Hướng dẫn khởi động nhanh

Xem nhanh

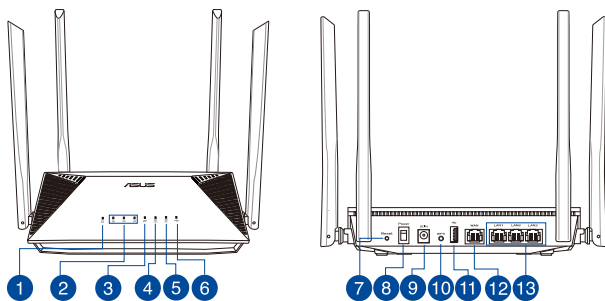

1 Đèn LED nguồn	8 Nút bật/tắt nguồn
2 Cổng LAN 1~3	9 Cổng nguồn (DC-IN)
3 Đèn LED WAN (Internet)	10 Nút WPS
4 Đèn LED 2,4GHz	11 Cổng USB 2.0
5 Đèn LED 5GHz	12 Cổng WAN (Internet)
6 Đèn LED USB 2.0	13 Cổng LAN 1~3
7 Nút khởi động lại	

Bố trí router không dây

Để truyền tín hiệu không dây tối ưu giữa router không dây và các thiết bị mạng vừa kết nối, đảm bảo bạn:

- Đặt router không dây ở khu vực trung tâm có phạm vi phủ sóng không dây tối đa dành cho các thiết bị mạng.
- Đặt thiết bị cách xa các vật cản kim loại và ánh sáng mặt trời trực tiếp.
- Đặt thiết bị cách xa các thiết bị Wi-Fi 802.11g hoặc 20MHz, thiết bị ngoại vi máy tính 2,4GHz, thiết bị Bluetooth, điện thoại di động, máy biến áp, động cơ công suất cao, ánh sáng huỳnh quang, lò vi sóng, tủ lạnh và các thiết bị công nghiệp khác để phòng tránh nhiễu hoặc mất tín hiệu.
- Luôn cập nhật bằng firmware mới nhất. Truy cập trang web ASUS tại <http://www.asus.com> để tải các cập nhật firmware mới nhất.
- Để đảm bảo tín hiệu không dây tối ưu, hãy định hướng 4 ăngten có không thể tháo rời như minh họa trong bảng vẽ dưới đây.

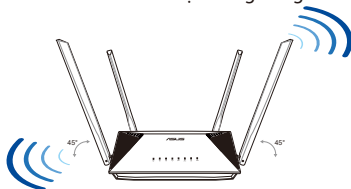

LƯU Ý:

- Chỉ nên sử dụng adapter kèm theo gói sản phẩm của bạn. Sử dụng các adapter khác có thể làm hỏng thiết bị.
- **Thông số kỹ thuật:**

Adapter nguồn DC	Đầu ra DC: +12V với dòng điện tối đa 1.5A		
Nhiệt độ hoạt động	0~40°C	Bảo quản	0~70°C
Độ ẩm hoạt động	50~90%	Bảo quản	20~90%

Chuẩn bị modem

1. **Ngắt cáp nguồn/modem DSL. Nếu có dùng pin dự phòng, hãy tháo pin ra.**

LƯU Ý: Nếu đang sử dụng DSL cho internet, bạn cần có tên người dùng/mật khẩu từ Nhà cung cấp Dịch vụ Internet (ISP) để thiết lập router đúng cách.

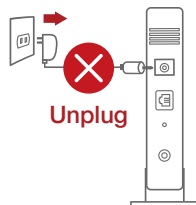

Tiếng Việt

2. **Kết nối modem của bạn với router bằng cáp mạng theo.**

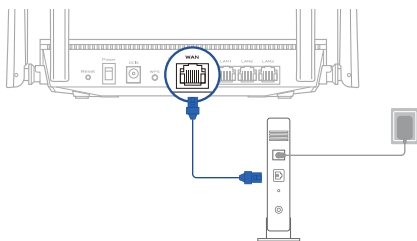

3. **Bật nguồn modem cáp/DSL.**
4. **Kiểm tra ánh sáng đèn LED trên modem cáp/DSL để đảm bảo kết nối đang hoạt động.**

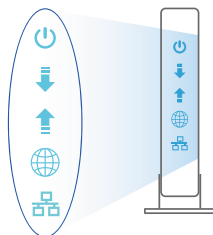

Thiết lập RT-AX53U

Để thiết lập router qua kết nối có dây hoặc không dây.

A. Kết nối có dây

1. Cắm router vào ổ cắm điện và bật nguồn router. Cắm cáp mạng từ máy tính vào cổng LAN trên router.

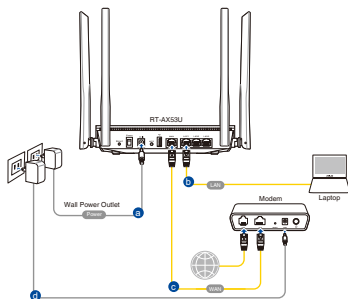

2. GUI (giao diện người dùng đồ họa) web sẽ tự động bật lên khi bạn mở trình duyệt web. Nếu nó không tự động bật lên, hãy nhập <http://router.asus.com>.
3. Thiết lập mật khẩu cho router để ngăn chặn truy cập trái phép.

Login Information Setup

Change the router password to prevent unauthorized access to your ASUS wireless router.

Router Login Name	<input type="text" value="admin"/>
New Password	<input type="password"/>
Retype Password	<input type="password"/> <input type="checkbox"/> Show password

B. Kết nối mạng không dây

1. Cắm router vào ổ cắm điện và bật nguồn router.

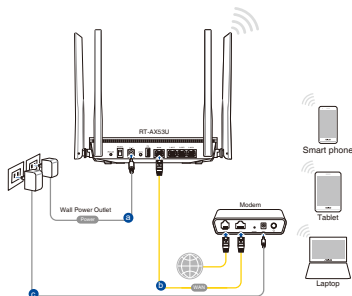

2. Kết nối với tên mạng (SSID) in trên nhãn sản phẩm ở phần dưới sau router. Để bảo mật mạng tốt hơn, hãy đổi sang SSID duy nhất và gán một mật khẩu.



Tên Wi-Fi (SSID):	ASUS_XX
-------------------	---------

* **XX** để cập đến hai số cuối của địa chỉ MAC. Bạn có thể tìm thấy nó trên nhãn ở phần dưới sau router.

3. Bạn có thể chọn Web GUI hoặc ứng dụng ASUS Router để thiết lập router.

a. Thiết lập Web GUI

- Một khi đã kết nối, GUI web sẽ tự động bật lên khi bạn mở trình duyệt web. Nếu nó không tự động bật lên, hãy nhập <http://router.asus.com>.
- Thiết lập mật khẩu cho router để ngăn chặn truy cập trái phép.

Login Information Setup

Change the router password to prevent unauthorized access to your ASUS wireless router.

Router Login Name

New Password

Retype Password Show password

b. Thiết lập ứng dụng

Tải về Ứng dụng ASUS Router để thiết lập router của bạn qua các thiết bị di động.

- **Bật Wi-Fi trên các thiết bị di động của bạn và kết nối với mạng của RT-AX53U.**
- **Thực hiện theo các hướng dẫn thiết lập Ứng dụng ASUS Router để hoàn tất quy trình thiết lập.**



ASUS Router



GET IT ON
Google Play



Download on the
App Store

Q ASUS Router

Ghi nhớ các cài đặt router không dây của bạn

- Ghi nhớ các cài đặt không dây khi bạn hoàn tất thiết lập router.

Tên router:	Mật khẩu:
SSID mạng 2,4 GHz:	Mật khẩu:
SSID mạng 5G Hz:	Mật khẩu:

Hỏi Đáp

- Tôi có thể tìm thêm thông tin về router không dây ở đâu?
 - Trang hỗ trợ kỹ thuật: <https://www.asus.com/support>
 - Bạn có thể truy cập sổ hướng dẫn sử dụng trực tuyến tại <https://www.asus.com/support>

ASUS Recycling/Takeback Services

ASUS recycling and takeback programs come from our commitment to the highest standards for protecting our environment. We believe in providing solutions for you to be able to responsibly recycle our products, batteries, other components, as well as the packaging materials. Please go to <http://csr.asus.com/english/Takeback.htm> for the detailed recycling information in different regions.

REACH

Complying with the REACH (Registration, Evaluation, Authorisation, and Restriction of Chemicals) regulatory framework, we published the chemical substances in our products at ASUS REACH website at <http://csr.asus.com/english/REACH.htm>.

Federal Communications Commission Statement

This device complies with Part 15 of the FCC Rules. Operation is subject to the following two conditions:

- This device may not cause harmful interference.
- This device must accept any interference received, including interference that may cause undesired operation.

This equipment has been tested and found to comply with the limits for a class B digital device, pursuant to part 15 of the FCC Rules. These limits are designed to provide reasonable protection against harmful interference in a residential installation.

This equipment generates, uses and can radiate radio frequency energy and, if not installed and used in accordance with the instructions, may cause harmful interference to radio communications. However, there is no guarantee that interference will not occur in a particular installation. If this equipment does cause harmful interference to radio or television reception, which can be determined by turning the equipment off and on, the user is encouraged to try to correct the interference by one or more of the following measures:

- Reorient or relocate the receiving antenna.
- Increase the separation between the equipment and receiver.
- Connect the equipment into an outlet on a circuit different from that to which the receiver is connected.
- Consult the dealer or an experienced radio/TV technician for help.



WARNING! Any changes or modifications not expressly approved by the party responsible for compliance could void the user's authority to operate the equipment.

Prohibition of Co-location

This device and its antenna(s) must not be co-located or operating in conjunction with any other antenna or transmitter.

IMPORTANT NOTE:

Radiation Exposure Statement: This equipment complies with FCC radiation exposure limits set forth for an uncontrolled environment. End users must follow the specific operating instructions for satisfying RF exposure compliance. To maintain compliance with FCC exposure compliance requirement, please follow operation instruction as documented in this manual.



WARNING! This equipment must be installed and operated in accordance with provided instructions and the antenna(s) used for this transmitter must be installed to provide a separation distance of at least 21 cm from all persons and must not be co-located or operating in conjunction with any other antenna or transmitter.

安全說明：

- 請在溫度為0°C (32°F)至40°C (104°F)之間的環境中使用本產品。
- 請依照產品上的電源功率貼紙說明使用正確的電源變壓器，如果選用錯誤規格的電源變壓器有可能會造成內部零件的損壞。
- 請勿將產品放置於不平坦或不穩定的表面，若產品的機殼毀損，請聯絡維修服務人員。
- 請勿在產品上放置其他物品，請勿將任何物品塞入產品內，以避免引起元件短路或電路損毀。
- 請保持機器在乾燥的環境下使用，雨水、溼氣、液體等含有礦物質將會腐蝕電子線路，請勿在雷電天氣下使用數據機。
- 請勿堵塞產品的通風孔，以避免因散熱不良而導致系統過熱。
- 請勿使用破損的電源線，附件或其他周邊產品。
- 如果電源已毀損，請不要嘗試自行修復，請將其交給專業技術服務人員或經銷商來處理。
- 為了防止電擊風險，在搬動主機之前，請先將電源線插頭暫時從電源插座上拔除。

NCC 警語

經型式認證合格之低功率射頻電機，非經許可，公司、商號或使用者均不得擅自變更頻率、加大功率或變更原設計之特性及功能。

低功率射頻電機之使用不得影響飛航安全及干擾合法通信；經發現有干擾現象時，應立即停用，並改善至無干擾時方得繼續使用。

前項合法通信，指依電信法規定作業之無線電通信。

低功率射頻電機須忍受合法通信或工業、科學及醫療用電波輻射性電機設備之干擾。

「產品之限用物質含有情況」之相關資訊，請參考下表：

單元	限用物質及其化學符號					
	鉛 (Pb)	汞 (Hg)	鎘 (Cd)	六價鉻 (Cr ⁶⁺)	多溴聯苯 (PBB)	多溴二苯醚 (PBDE)
印刷電路板及電子組件	○	○	○	○	○	○
結構組件（金屬 / 塑膠）	○	○	○	○	○	○
其他組件（如天線 / 指示燈 / 連接線）	○	○	○	○	○	○
其他及其配件（如電源供應器）	○	○	○	○	○	○

備考1. “○” 係指該項限用物質之百分比含量未超出百分比含量基準值。
備考2. “-” 係指該項限用物質為排除項目。

DFS 警語

操作在 5.15-5.35/5.47-5.85GHz 之無線資訊傳輸設備 (802.11a/ac 產品)，應避免影響附近雷達系統之操作。

MPE

本產品電磁波曝露量 (MPE) 標準值 $1\text{mW}/\text{cm}^2$ ，送測產品實測值為 $0.938\text{mW}/\text{cm}^2$ ，建議使用時至少距離人體 20cm。

品名：RT-AX53U 無線雙頻路由器

產品規格：12Vdc，1.5A

华硕的联络信息

华硕电脑（上海）有限公司 ASUSTEK COMPUTER
(SHANGHAI) CO., LTD (中国)

市场信息

地址：上海市闵行区金都路 5077 号

电话：+86-21-54421616

传真：+86-21-54420088

互联网：<https://www.asus.com.cn/>

技术支持

电话：400-620-6655

电子邮件：[https://vip.asus.com/VIP2/Services/
TechQuery?lang=zh-cn](https://vip.asus.com/VIP2/Services/TechQuery?lang=zh-cn)

华硕电脑公司 ASUSTeK COMPUTER INC. (亚太地区)

市场信息

地址：台北市北投区立德路15号1楼

电话：+886-2-2894-3447

传真：+886-2-2890-7798

电子邮件：info@asus.com.tw

互联网：<https://www.asus.com/tw>

技术支持

电话：+86-21-38429911

传真：+86-21-58668722, ext. 9101#

在线支持：<https://www.asus.com/tw/support/>

Manufacturer: **ASUSTeK Computer Inc.**

Tel: +886-2-2894-3447

Address: 1F., No. 15, Lide Rd., Beitou Dist., Taipei City
112, Taiwan

華碩電腦股份有限公司

電話：+886-2-2894-3447

地址：台灣台北市北投區立德路15號

Networks Global Hotline Information

Area	Country/ Region	Hotline Number	Service Hours
Europe	Cyprus	800-92491	09:00-13:00 ; 14:00-18:00 Mon-Fri
	France	0033-170949400	09:00-18:00 Mon-Fri
	Germany	0049-1805010920 0049-1805010923 (component support)	09:00-18:00 Mon-Fri 10:00-17:00 Mon-Fri
		0049-2102959911 (Fax)	
		Hungary	0036-15054561
	Italy	06 97626662	09:00-13:00 ; 14:00-18:00 Mon-Fri
	Greece	00800-44142044	09:00-13:00 ; 14:00-18:00 Mon-Fri
	Austria	0043-820240513	09:00-18:00 Mon-Fri
	Netherlands/ Luxembourg	0031-591570290	09:00-17:00 Mon-Fri
	Belgium	0032-78150231	09:00-17:00 Mon-Fri
	Norway	0047-2316-2682	09:00-18:00 Mon-Fri
	Sweden	0046-858769407	09:00-18:00 Mon-Fri
	Finland	00358-969379690	10:00-19:00 Mon-Fri
	Denmark	0045-38322943	09:00-18:00 Mon-Fri
	Poland	0048-225718040	08:30-17:30 Mon-Fri
	Spain	0034-902889688	09:00-18:00 Mon-Fri
	Portugal	00351-707500310	09:00-18:00 Mon-Fri
	Slovak Republic	00421-232162621	08:00-17:00 Mon-Fri
	Czech Republic	00420-596766888	08:00-17:00 Mon-Fri
	Switzerland- German	0041-848111010	09:00-18:00 Mon-Fri
Switzerland- French	0041-848111014	09:00-18:00 Mon-Fri	
Switzerland- Italian	0041-848111012	09:00-18:00 Mon-Fri	
United Kingdom	0044-1442265548	09:00-17:00 Mon-Fri	
Ireland	0035-31890719918	09:00-17:00 Mon-Fri	
Russia and CIS	008-800-100-ASUS	09:00-18:00 Mon-Fri	
Ukraine	0038-0445457727	09:00-18:00 Mon-Fri	

Networks Global Hotline Information

Area	Country/ Region	Hotline Numbers	Service Hours
Asia-Pacific	Australia	1300-278788	09:00-18:00 Mon-Fri
	New Zealand	0800-278788	09:00-18:00 Mon-Fri
	Japan	0800-1232787	09:00-19:00 Mon-Sun
		0081-570783886 (Non-Toll Free)	09:00-19:00 Mon-Sun
	Korea	0082-215666868	09:30-17:00 Mon-Fri
	Thailand	0066-24011717	09:00-18:00 Mon-Fri
		1800-8525201	
	Singapore	0065-64157917	11:00-19:00 Mon-Fri
		0065-67203835 (Repair Status Only)	11:00-19:00 Mon-Fri 11:00-13:00 Sat
	Malaysia	1300-88-3495	9:00-18:00 Mon-Fri
	Philippine	1800-18550163	09:00-18:00 Mon-Fri
	India	1800-2090365	09:00-18:00 Mon-Sat
	India(WL/NW)		09:00-21:00 Mon-Sun
	Indonesia	0062-2129495000	09:30-17:00 Mon-Fri
500128 (Local Only)		9:30 – 12:00 Sat	
Vietnam	1900-555581	08:00-12:00 13:30-17:30 Mon-Sat	
Hong Kong	00852-35824770	10:00-19:00 Mon-Sat	
Taiwan	0800-093-456;	9:00-12:00 Mon-Fri;	
	02-81439000	13:30-18:00 Mon-Fri	
Americas	USA		8:30-12:00 EST Mon-Fri
	Canada	1-812-282-2787	9:00-18:00 EST Sat-Sun
	Mexico	001-8008367847	08:00-20:00 CST Mon-Fri
			08:00-15:00 CST Sat
Brazil	4003 0988 (Capital) 0800 880 0988 (demais localidades)	9:00am-18:00 Mon-Fri	

Networks Global Hotline Information

Area	Country/ Region	Hotline Numbers	Service Hours
Middle East + Africa	Egypt	800-2787349	09:00-18:00 Sun-Thu
	Saudi Arabia	800-1212787	09:00-18:00 Sat-Wed
	UAE	00971-42958941	09:00-18:00 Sun-Thu
	Turkey	0090-2165243000	09:00-18:00 Mon-Fri
	South Africa	0861-278772	08:00-17:00 Mon-Fri
	Israel	*6557/00972-39142800 *9770/00972-35598555	08:00-17:00 Sun-Thu 08:30-17:30 Sun-Thu
Balkan Countries	Romania	0040-213301786	09:00-18:30 Mon-Fri
	Bosnia Herzegovina	00387-33773163	09:00-17:00 Mon-Fri
	Bulgaria	00359-70014411	09:30-18:30 Mon-Fri
		00359-29889170	09:30-18:00 Mon-Fri
	Croatia	00385-16401111	09:00-17:00 Mon-Fri
	Montenegro	00382-20608251	09:00-17:00 Mon-Fri
	Serbia	00381-112070677	09:00-17:00 Mon-Fri
Slovenia	00368-59045400	08:00-16:00 Mon-Fri	
	00368-59045401		
Baltic Countries	Estonia	00372-6671796	09:00-18:00 Mon-Fri
	Latvia	00371-67408838	09:00-18:00 Mon-Fri
	Lithuania-Kaunas	00370-37329000	09:00-18:00 Mon-Fri
	Lithuania-Vilnius	00370-522101160	09:00-18:00 Mon-Fri

NOTES:

- UK support e-mail: network_support_uk@asus.com
- For more information, visit the ASUS support site at: <https://www.asus.com/support/>

CE statement

Simplified EU Declaration of Conformity

ASUSTek Computer Inc. hereby declares that this device is in compliance with the essential requirements and other relevant provisions of Directive 2014/53/EU. Full text of EU declaration of conformity is available at https://www.asus.com/Networking-LoT-Servers/WiFi-Routers/ASUS-WiFi-Routers/RT-AX53U/HelpDesk_Declaration/.

Declaration of Conformity for Ecodesign directive 2009/125/EC

Testing for eco-design requirements according to (EC) No 1275/2008 and (EU) No 801/2013 has been conducted. When the device is in Networked Standby Mode, its I/O and network interface are in sleep mode and may not work properly. To wake up the device, press the WPS button.

This equipment complies with EU radiation exposure limits set forth for an uncontrolled environment. This equipment should be installed and operated with minimum distance 31 cm between the radiator & your body.

All operational modes:

2.4GHz: 802.11b, 802.11g, 802.11n (HT20), 802.11n (HT40), 802.11ac (VHT20), 802.11ac (VHT40), 802.11ax (HE20), 802.11ax(HE40)

5GHz: 802.11a, 802.11n (HT20), 802.11n (HT40), 802.11ac (VHT20), 802.11ac (VHT40), 802.11ac (VHT80), 802.11ax (HE20), 802.11ax(HE40), 802.11ax (HE80)

The frequency, mode and the maximum transmitted power in EU are listed below:

2400-2483.5MHz(1-13): OFDM: 19.84dBm; CCK:19.76dBm

5150-5250MHz (36-48): 22.81dBm

5250-5350MHz (52-64): 22.79dBm

5470-5725MHz (100-140): 28.81dBm

The device is restricted to indoor use only when operating in the 5150 to 5350 MHz frequency range. The adapter shall be installed near the equipment and shall be easily accessible.

	AT	BE	BG	CZ	DK	EE	FR
	DE	IS	IE	IT	EL	ES	CY
	LV	LI	LT	LU	HU	MT	NL
	NO	PL	PT	RO	SI	SK	TR
	FI	SE	CH	UK	HR	UA	



Safety Notices

- Use this product in environments with ambient temperatures between 0°C(32°F) and 40°C(104°F).
- Refer to the rating label on the bottom of your product and ensure your power adapter complies with this rating.
- DO NOT place on uneven or unstable work surfaces. Seek servicing if the casing has been damaged.
- DO NOT place or drop objects on top and do not shove any foreign objects into the product.
- DO NOT expose to or use near liquids, rain, or moisture. DO NOT use the modem during electrical storms.
- DO NOT cover the vents on the product to prevent the system from getting overheated.
- DO NOT use damaged power cords, accessories, or other peripherals.
- If the Adapter is broken, do not try to fix it by yourself. Contact a qualified service technician or your retailer.
- To prevent electrical shock hazard, disconnect the power cable from the electrical outlet before relocating the system.
- DO NOT mount this equipment higher than 2 meters.



India RoHS



This product complies with the "India E-Waste (Management) Rules, 2016" and prohibits use of lead, mercury, hexavalent chromium, polybrominated biphenyls(PBBs) and polybrominated diphenyl ethers (PBDEs) in concentrations exceeding 0.1 % by weight in homogenous materials and 0.01 % by weight in homogenous materials for cadmium, except for the exemptions listed in Schedule II of the Rule.



