

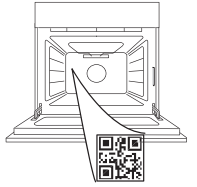

THANK YOU FOR BUYING A WHIRLPOOL PRODUCT

In order to receive a more complete assistance, please register your product on www.whirlpool.eu/register

PLEASE SCAN THE QR CODE ON YOUR APPLIANCE IN ORDER TO REACH MORE INFORMATION



Before using the appliance carefully read the Safety Instruction.

PRODUCT DESCRIPTION

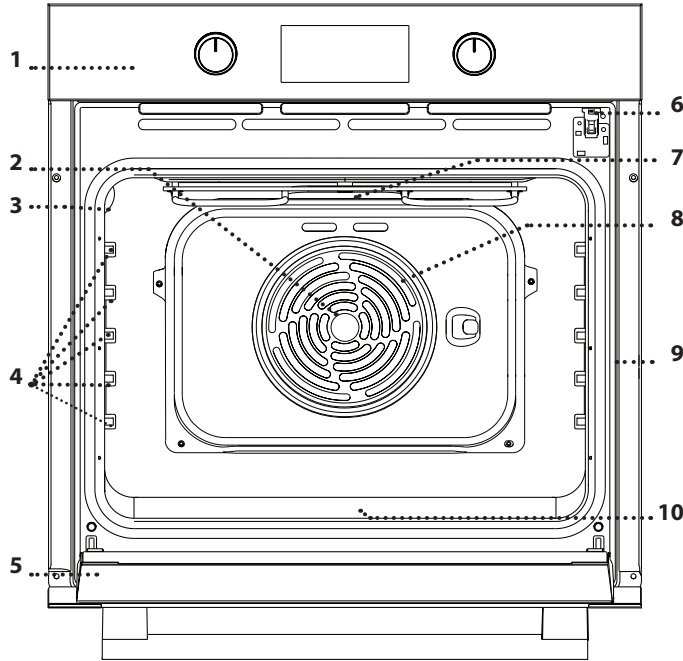

1. Control panel
2. Fan
3. Lamp
4. Shelf guides (the level is indicated on the wall of the cooking compartment)
5. Door
6. Door lock (locks the door while automatic cleaning is in progress and afterwards)
7. Top heating element/grill
8. Circular heating element (not visible)
9. Identification plate (do not remove)
10. **STEAM** embossing for drinking water

CONTROL PANEL DESCRIPTION

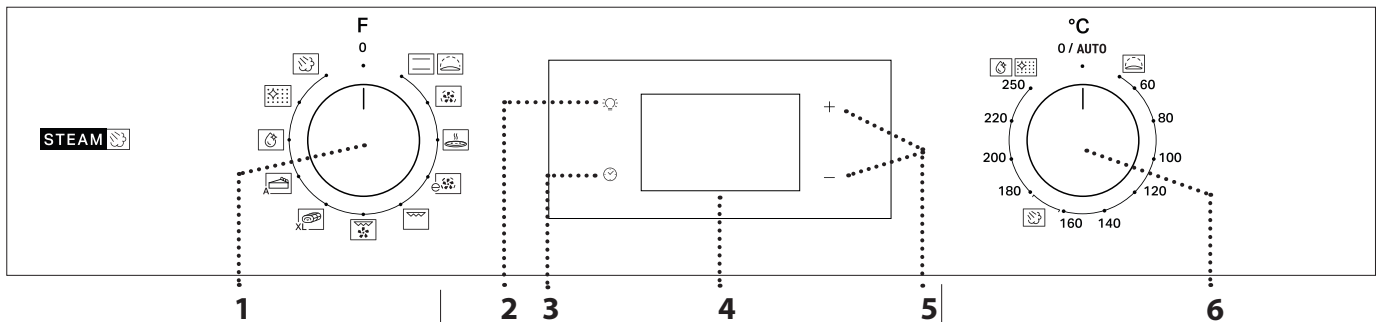

1. SELECTION KNOB

For switching the oven on by selecting a function. Turn to the 0 position to switch the oven off.

2. LIGHT

With the oven switched on, press to turn the oven compartment lamp on or off.

3. SETTING THE TIME

For accessing the cooking time settings, delayed start and timer. For displaying the time when the oven is off.

4. DISPLAY

5. ADJUSTMENT BUTTONS

For changing the cooking time settings.

6. THERMOSTAT KNOB

Turn to select the temperature you require when activating manual functions.

Please note: Type of knob may vary from model type. If the knobs are push-activated, push down on the center of the knob to release it from seating.

ACCESSORIES

WIRE SHELF

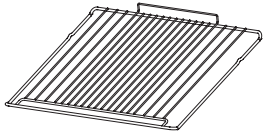

Use to cook food or as a support for pans, cake tins and other ovenproof items of cookware.

DRIP TRAY *

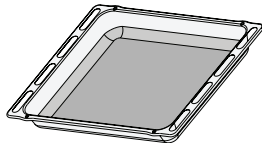

Use as an oven tray for cooking meat, fish, vegetables, focaccia, etc. or position underneath the wire shelf to collect cooking juices.

BAKING TRAY *

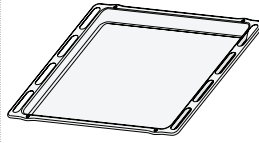

Use for cooking all bread and pastry products, but also for roasts, fish en papillote, etc.

SLIDING RUNNERS *

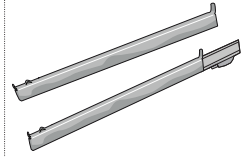

To facilitate inserting or removing accessories.

* Available only on certain models

The number and the type of accessories may vary depending on which model is purchased.

Other accessories can be purchased separately from the After-sales Service.

INSERTING THE WIRE SHELF AND OTHER ACCESSORIES

Insert the wire shelf onto the level you require by holding it tilted slightly upwards and resting the raised rear side (pointing upwards) down first.

Then slide it horizontally along the runners as far as possible.

Other accessories, like the baking tray, are to be inserted horizontally, letting them slide on the runners.

SLIDING SHELVES AND SHELF GUIDES

Before using the oven remove the protective tape [a] and then remove the protective foil [b] from the sliding runners.

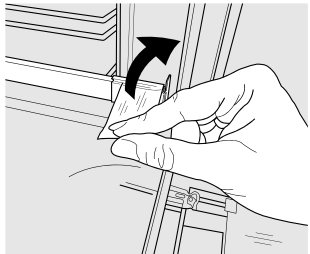

[a]

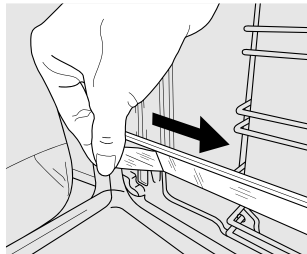

[b]

REMOVING THE SLIDING RUNNERS [c]

Pull the lower part of the sliding runner to uncouple the lower hooks (1) and pull the sliding runners upwards, removing them from the upper hooks (2).

REFITTING THE SLIDING RUNNERS [d]

Hook the upper hooks on the shelf guides (1) then press the lower part of the sliding runners against the shelf guides, until the lower hooks are clicking (2).

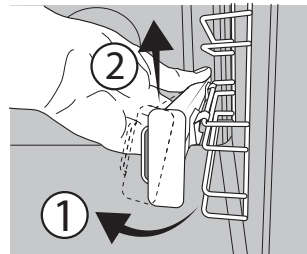

[c]

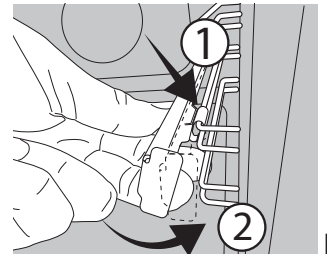

[d]

REMOVING AND REFITTING THE SHELF GUIDES

1. To remove the shelf guides, firmly grip the external part of the guide, and pull it towards you to extract the support and the two internal pins from the lodging.

2. To reposition the shelf guides, position them near the cavity and initially insert the two pins into their lodgings. Next, position the external part near its lodging, insert the support, and firmly press towards the wall of the cavity to make sure the shelf guide is properly secured.

FUNCTIONS

CONVENTIONAL

For cooking any kind of dish on one shelf only.

RISING

For helping sweet or savoury dough to rise effectively. Turn the *thermostat knob* to the icon to activate this function.

FORCED AIR

For cooking different foods that require the same cooking temperature on several shelves (maximum three) at the same time. This function can be used to cook different foods without odours being transferred from one food to another.

PIZZA

For baking different types and sizes of pizza and bread. It is a good idea to swap the position of the baking trays halfway through cooking.

ECO FORCED AIR

For cooking roasts and stuffed roasting joints on a single shelf. Food is prevented from drying out excessively by gentle, intermittent air circulation.

When this ECO function is in use, the light will remain switched off during cooking but can be switched on again by pressing .

GRILL

For grilling steaks, kebabs and sausages, cooking vegetables au gratin or toasting bread. When grilling meat, we recommend using a dripping pan to collect the cooking juices: position the pan on any of the levels below the wire shelf and add 200 ml of drinking water.

TURBO GRILL

For roasting large joints of meat (legs, roast beef, chicken). We recommend using a dripping pan to collect the cooking juices: position the pan on any of the levels below the wire shelf and add 200 ml of drinking water.

MAXI COOKING

For cooking large joints of meat (above 2.5 kg).

We recommend turning the meat over during cooking to ensure that both sides brown evenly. We also recommend basting the joint every so often to prevent it from drying out excessively.

PASTRY AUTO

This function automatically selects the ideal temperature and baking time for cakes. Activate the function when the oven is cold.

STEAM +

The Steam+ function allows to obtain excellent performances thanks to the presence of steam in the cooking cycle. This function automatically manages the ideal temperature for cooking a wide range of recipes; the cooking times of the main dishes are shown in the relative cooking table. Always activate the steam function when the oven is cold, and after pouring 200 ml of drinking water into the bottom of the cavity. To activate Steam+ function, the thermostat knob needs to be turned in to position of .

FLEXI CLEAN PACK

SMARTCLEAN



The action of the steam released during this special low-temperature cleaning cycle allows dirt and food residues to be removed with ease. To activate the "Smart Clean" function, pour 100-120 ml of drinking water on the bottom of the oven then turn the selection knob and the thermostat knob to the  icon. It is best to use the function for 35'. Activate the function when the oven is cold. The position of the icon does not correspond to the temperature reached during the cleaning cycle.

AUTOMATIC CLEANING - PYRO



For eliminating cooking spatters using a cycle at very high temperature. To activate this function move thermostat knob to . The position of the icon does not correspond to the real temperature reached during the cleaning cycle.

FIRST TIME USE

1. SETTING THE TIME

You will need to set the time when you switch on the appliance for the first time: Press  until the  icon and the two digits for the hour start flashing on the display.



Use + or - to set the hour and press  to confirm. The two digits for the minutes will start flashing. Use + or - to set the minutes and press  to confirm.

Please note: When the  icon is flashing, for example following lengthy power outages, you will need to reset the time.

2. SET THE POWER CONSUMPTION

By default the oven is programmed to work at a power higher than 3kW (Hi). To operate the oven at a power that is compatible with a domestic power supply less than 2,9 kW (Lo), you will need to change the settings.

To go to the change menu, turn the *selection knob* to , then turn it back to 0.

Press and hold + and - for five seconds immediately afterwards.



Use + or - to change the setting, then press and hold  for at least two seconds to confirm.

3. HEAT THE OVEN

A new oven may release odours that have been left behind during manufacturing: this is completely normal. Before starting to cook food, we therefore recommend heating the oven with it empty in order to remove any possible odours.

Remove any protective cardboard or transparent film from the oven and remove any accessories from inside it.

Heat the oven to 250 °C for about one hour. The oven must be empty during this time.

Please note: It is advisable to air the room after using the appliance for the first time.

DAILY USE

1. SELECT A FUNCTION

To select a function, turn the *selection knob* to the symbol for the function you require: the display will light up and an audible signal will sound.



2. ACTIVATE A FUNCTION

MANUAL

To start the function you have selected, turn the *thermostat knob* to set the temperature you require.



Please note: During cooking you can change the function by turning the selection knob or adjust the temperature by turning the thermostat knob. The function will not start if the thermostat knob will be on **0 / AUTO** position (except for PASTRY AUTO function). You can set the cooking time, cooking end time (only if you set a cooking time) and a timer.

RISING

To start the "Rising" function, turn the *thermostat knob* to Rising position (40 deg) and put function knob in Conventional position; if the oven is set to a different temperature, the function will not start.

Please note: You can set the cooking time, cooking end time (only if you set a cooking time) and a timer.

STEAM

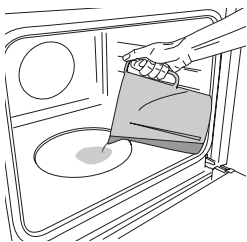



To start the Steam function, pour 200 ml of drinking water in the oven bottom. Select the function turning clockwise the selection knob on the relevant icon, and the thermostat knob in any position between 160 and 180°C (as suggested by the icon). The function will start and the display

will show the current time of the day. No preheating is needed. To end the cooking, turn the selection knob on **0** position. During Steam cooking do not open the door and never top up the water.

Please note: Opening the door and topping up the water during cooking may have an adverse effect on the final cooking result.

3. PREHEATING AND RESIDUAL HEAT

Once the function starts, an audible signal and a flashing icon  on the display indicate that the preheating phase has been activated. At the end of this phase, an audible signal and the fixed icon  on the display will indicate that the oven has reached the set temperature: at this point, place the food inside and proceed with cooking.

Please note: Placing the food in the oven before preheating has finished may have an adverse effect on the final cooking result.

After cooking and with the function deactivated, the icon  may continue to remain visible on the display even after the cooling fan has switched off to indicate that there is residual heat in the compartment.

Please note: The time after which the icon switches off varies because it depends on a series of factors such as ambient temperature and function used. In any case, the product should be considered to be off when the pointer on the selection knob is at "0".

4. PROGRAMMING COOKING

You will need to select a function before you can start programming cooking.



DURATION

Keep pressing  until the  icon and "00:00" start flashing on the display.





Use + or - to set the cooking time you require, then press  to confirm.

Activate the function by turning the *thermostat knob* to the temperature you require: an audible signal will sound and the display will indicate that cooking is complete.

Please note: To cancel the cooking time you have set, keep pressing  until the  icon starts flashing on the display, then use - to reset the cooking time to "00:00". This cooking time includes a preheating phase.

PROGRAMMING THE END COOKING TIME/ DELAYED START

After a cooking time has been set, starting the function can be delayed by programming its end time: press  until the  icon and the current time start flashing on the display.

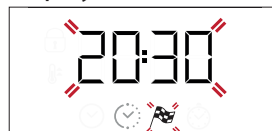

Use + or - to set the time you want cooking to end and press  to confirm.

Activate the function by turning the *thermostat knob* to the temperature you require: the function will remain paused until it starts automatically after the period of time that has been calculated in order for cooking to finish at the time you have set.

Please note: To cancel the setting, switch the oven off by turning the *selection knob* to the 0 position.

Delay to start functionality is not available for Grill and Turbo Grill functions.

END OF COOKING

An audible signal will sound and the display will indicate that the function has finished.





Turn the *selection knob* to select a different function or to 0 to switch the oven off.

Please note: If the timer is active, the display will show "END" alternately with the remaining time.

5. SETTING THE TIMER

This option does not interrupt or program cooking but allows you to use the display as a timer, either during while a function is active or when the oven is off.

Keep pressing  until the  and "00:00" icon and "00:00" start flashing on the display.



Use + or - to set the time you require and press  to confirm. An audible signal will sound once the timer has finished counting down the selected time.

Notes: To cancel the timer, keep pressing  until the  icon starts flashing, then use - to reset the time to "00:00".

6. AUTOMATIC CLEANING FUNCTION – PYRO

Do not touch the oven during the Pyro cycle. Keep children and animals away from the oven during and after (until the room has finished airing) running the Pyro cycle.

Remove all accessories - including shelf guides - from the oven before activating the function. If the oven is installed below a hob, make sure that all the burners or electric hotplates are switched off while running the selfcleaning cycle.

For optimum cleaning results, remove the worst soiling with a damp sponge before using the Pyro function.

Avoid activating the pyro cycle cleaning in the presence of limescale residues.

















































































We recommend only running the Pyro function if the appliance contains heavy soiling or gives off bad odours during cooking.











To activate the automatic cleaning function, turn the *selection knob* and the *thermostat knob* to the  icon. The function will be activated automatically, the door locked and the light inside the oven switched off: The display will show the time remaining to the end, alternating with "Pyro".



Once the cycle has been completed, the door remains locked until the temperature inside the oven has returned to a safe level. Air the room during and after running the Pyro cycle.

COOKING TABLE

RECIPE	FUNCTION	PREHEAT	TEMPERATURE (°C)	DURATION (Min)	LEVEL AND ACCESSORIES
Leavened cakes		Yes	170	30 - 50	2 
		Yes	160	30 - 50	2 
		Yes	160	40 - 60	4  1 
Filled cake (cheese cake, strudel, fruit pie)		Yes	160 - 200	35 - 90	2 
		Yes	160 - 200	40 - 90	4  2 
Biscuits / tartlets		Yes	160	25 - 35	3 
		Yes	160	25 - 35	3 
		Yes	150	35 - 45	4  2 
Choux buns		Yes	180 - 210	30 - 40	3 
		Yes	180 - 200	35 - 45	4  2 
		Yes	180 - 200	35 - 45	5  3  1 
Meringues		Yes	90	150 - 200	3 
		Yes	90	140 - 200	4  2 
		Yes	90	140 - 200	5  3  1 
Pizza / Focaccia		Yes	190 - 250	15 - 50	1 / 2 
		Yes	190 - 250	20 - 50	4  2 
Frozen pizza		Yes	250	10 - 20	3 
		Yes	230-250	10 - 25	4  2 
Salty cakes (vegetable pie, quiche)		Yes	180 - 200	40 - 55	3 
		Yes	180 - 200	45 - 60	4  2 
		Yes	180 - 200	45 - 60	5  3  1 
Vols-au-vents / puff pastry crackers		Yes	190 - 200	20 - 30	3 
		Yes	180 - 190	20 - 40	4  2 
		Yes	180 - 190	20 - 40	5  3  1 
Lasagne / baked pasta / canneloni / flans		Yes	190 - 200	45 - 65	2 
Lamb / veal / beef / pork 1 kg		Yes	190 - 200	80 - 110	3 
Roast pork with crackling 2 kg		Yes	180 - 190	110 - 150	3 
Chicken / rabbit / duck 1 kg		Yes	200 - 230	50 - 100	2 
Turkey / goose 3 kg		-	190 - 200	100 - 160	2 
Baked fish / en papillote (fillets, whole)		Yes	170 - 190	30 - 45	2 
Stuffed vegetables (tomatoes, courgettes, aubergines)		Yes	180 - 200	50 - 70	3 
Toasted bread		5'	250	2 - 6	5 

ACCESSORIES	 Wire shelf	 Baking dish on the wire shelf	 Baking tray/Drip tray or baking dish on the wire shelf	 Drip tray / Baking tray	 Drip tray / Baking tray with 200 ml of water	
FUNCTIONS	 Conventional	 Forced air	 Pizza	 Grill	 Turbo grill	 Eco forced air

RECIPE	FUNCTION	PREHEAT	TEMPERATURE (°C)	DURATION (Min)	LEVEL AND ACCESSORIES
Fish fillets / slices		-	230 - 250	15 - 30 *	4 3
Sausages / kebabs / spare ribs / hamburgers		-	250	15 - 30 *	5 4
Roast chicken 1-1.3 kg		Yes	200 - 220	55 - 70 **	2 1
Roast beef rare 1 kg		Yes	200 - 210	35 - 50 **	3
Leg of lamb / knuckle		Yes	200 - 210	60 - 90 **	3
Roast potatoes		Yes	200 - 210	35 - 55	2
Vegetable gratin		-	200 - 210	25 - 55	3
Meat and potatoes		Yes	190 - 200	45 - 100 ***	4 1
Fish and vegetables		Yes	180	30 - 50 ***	4 2
Lasagne and meat		Yes	200	50 - 100 ***	4 1
Complete meal: fruit tart (level 5) / lasagne (level 3) / meat (level 1)		Yes	180 - 190	40 - 120 ***	5 3 1
Roast meat / stuffed roasting joints		-	170 - 180	100 - 150	3

* Turn food halfway through cooking

** Turn food two thirds of the way through cooking (if necessary).

*** Estimated length of time: dishes can be removed from the oven at different times depending on personal preference.

COOKING TABLE STEAM+

FOOD	RECIPE	QUANTITY	TIME (min)	ACCESSORIES	LEVEL	WATER
BREAD	Small breads	80-100 g	30 - 45		2	200 ml
	Sandwich loaf in tin	300-500 g	40 - 60			
	Bread	500g-2 kg	50 - 100			
	Baguettes	200-300 g	30 - 45			
MEAT	Roast	1 kg	60 - 110			
	Ribs	500g-1,5 kg	50 - 75			
	Chicken	1-1,5 kg	55 - 80			
	Chicken/Turkey	3 kg	100 - 140			
FISH	Fillet Steak	0.5-2 cm	15 - 25			
	Fillet Steak	2-4 cm	20 - 35			
	Whole Fish	300- 600 g	20 - 30			
	Whole Fish	600 -1200 g	25 - 45			
VEGETABLES	Steamed Potatoes	0.5-1.5 kg	45 - 60			
	Stuffed Peppers	1-2 kg	35 - 55			
	Steamed Broccoli	0.3-1 kg	30 - 50			
	Steamed Zucchini	0.5-1.5 kg	30 - 50			
PASTRIES	Cookies	a tray	25 - 35			
	Muffin	30-60 g	25 - 45			
	Sponge Cake	500-700 g	30 - 50			
	Tart	a tin	35 - 55			

Start the STEAM+ function only when the oven is cold. Opening the door and topping up the water during cooking may have an adverse effect on the final cooking result.

ACCESSORIES	Wire shelf	Baking dish on the wire shelf	Baking tray/Drip tray or baking dish on the wire shelf	Drip tray / Baking tray	Drip tray / Baking tray with 200 ml of water	
FUNCTIONS	Conventional	Forced air	Pizza	Grill	Turbo grill	Eco forced air

CLEANING AND MAINTENANCE

Make sure that the oven has cooled down before carrying out any maintenance or cleaning.

Do not use steam cleaners.

Do not use wire wool, abrasive scourers or abrasive/corrosive cleaning agents, as these could damage the surfaces of the appliance.

Wear protective gloves.

The oven must be disconnected from the mains before carrying out any kind of maintenance work.

EXTERIOR SURFACES

Clean the surfaces with a damp microfibre cloth. If they are very dirty, add a few drops of pH-neutral detergent. Finish off with a dry cloth.

Do not use corrosive or abrasive detergents. If any of these products inadvertently comes into contact with the surfaces of the appliance, clean immediately with a damp microfibre cloth.

INTERIOR SURFACES

• After every use, leave the oven to cool and then clean it, preferably while it is still warm, to remove any deposits or stains caused by food residues. To dry any condensation that has formed as a result of cooking foods with a high water content, leave the oven to cool completely and then wipe it with a cloth or sponge.

• To remove the remaining limescale from the bottom of the cavity after the **STEAM** cooking, we recommend to clean the cavity with the products provided by After

Sales Service (please follow instructions attached to the product).

Cleaning is recommended at least for every 5 to 10 **STEAM** cooking cycles.

- If there is stubborn dirt on the interior surfaces, we recommend running the automatic cleaning function for optimal cleaning results. Avoid activating the pyrolytic cycle cleaning in the presence of limescale residues. Before activating, perform limescale cleaning as described above.
- The door can be easily removed and refitted to facilitate cleaning of the glass.
- Clean the glass in the door with a suitable liquid detergent.

ACCESSORIES

Soak the accessories in a washing-up liquid solution after use, handling them with oven gloves if they are still hot. Food residues can be removed using a washing-up brush or a sponge.

REMOVING AND REFITTING THE DOOR

1. To remove the door, open it fully and lower the catches until they are in the unlock position.

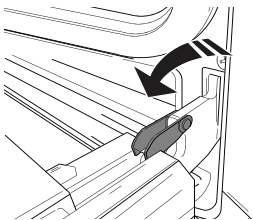

2. Close the door as much as you can.

Take a firm hold of the door with both hands – do not hold it by the handle. Simply remove the door by continuing to close it while pulling it upwards (a) at the same time until it is released from its seating (b). Put the door to one side, resting it on a soft surface.

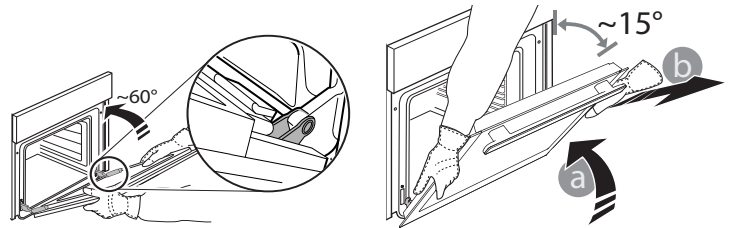

3. Refit the door by moving it towards the oven, aligning the hooks of the hinges with their seating and securing the upper part onto its seating.

4. Lower the door and then open it fully.

Lower the catches into their original position: Make sure that you lower them down completely.

5. Try closing the door and check to make sure that it lines up with the control panel. If it does not, repeat the steps above.

REPLACING THE LAMP

1. Disconnect the oven from the power supply.
2. Unscrew the cover from the light, replace the bulb and screw the cover back on the light.
3. Reconnect the oven to the power supply.

Please note: Use 25 W/230 V type G9, T300 °C halogen lamps. The bulb used in the product is specifically designed for domestic appliances and is not suitable for general room lighting within the home (EC Regulation 244/2009).

Light bulbs are available from our After-sales Service. - Do not handle bulbs with your bare hands as your fingerprints could damage them. Do not use the oven until the light cover has been refitted.

CLEANING OF THE DOOR GLASSES

1. After removing the door and resting it on a soft surface with the handle downwards, simultaneously press the two retaining clips and remove the upper edge of the door by pulling it towards you.

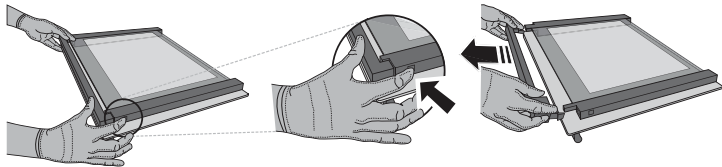

2. Lift and firmly hold the inner glass with both hands, remove it and place it on a soft surface before cleaning it.

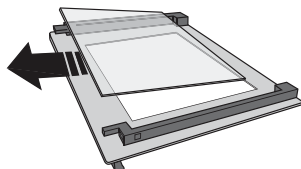

3. Refit the intermediate pane (marked with "1R") before refitting the inside pane: To position the panes of glass correctly, make sure that the "R" mark can be seen in the left-hand corner. First insert the long side of the glass marked "R" into the support seats, then lower it into position. Repeat this procedure for both panes of glass.

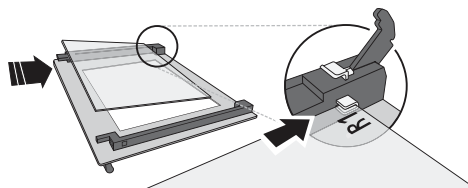

4. Refit the upper edge: A click will indicate correct positioning. Make sure the seal is secure before refitting the door.

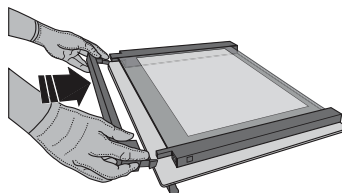

TROUBLESHOOTING

PROBLEM	POSSIBLE CAUSE	SOLUTION
The oven is not working.	Power cut. Disconnection from the mains.	Check for the presence of mains electrical power and whether the oven is connected to the electricity supply. Turn off the oven and restart it to see if the fault persists.
The display shows the letter "F" followed by a number or letter.	Oven failure.	Contact your nearest Client After-sales Service Centre and state the number following the letter "F".
The display is showing the message "Hot" and the selected function will not start.	Temperature too high.	Allow the oven to cool down before activating the function. Select a different function.
The display shows unclear text and appears to be broken.	Another language set.	Contact your nearest Client After-sales Service Center.

* Available only on certain models

Policies, standard documentation and additional product information can be found by:

- Using the QR code in your appliance
- Visiting our website docs.whirlpool.eu
- Alternatively, **contact our After-sales Service** (See phone number in the warranty booklet). When contacting our After-sales Service, please state the codes provided on your product's identification plate.

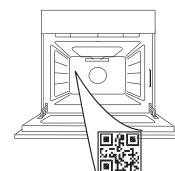

Whirlpool



400011705355



**GRAZIE PER AVER ACQUISTATO UN
PRODOTTO WHIRLPOOL**

Per ricevere un'assistenza più completa, registrare il prodotto su www.whirlpool.eu/register

**SCANSIONARE IL CODICE QR
SUL PROPRIO APPARECCHIO
PER OTTENERE MAGGIORI
INFORMAZIONI**

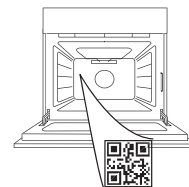

Prima di utilizzare l'apparecchio leggere attentamente le istruzioni di sicurezza.

DESCRIZIONE DEL PRODOTTO

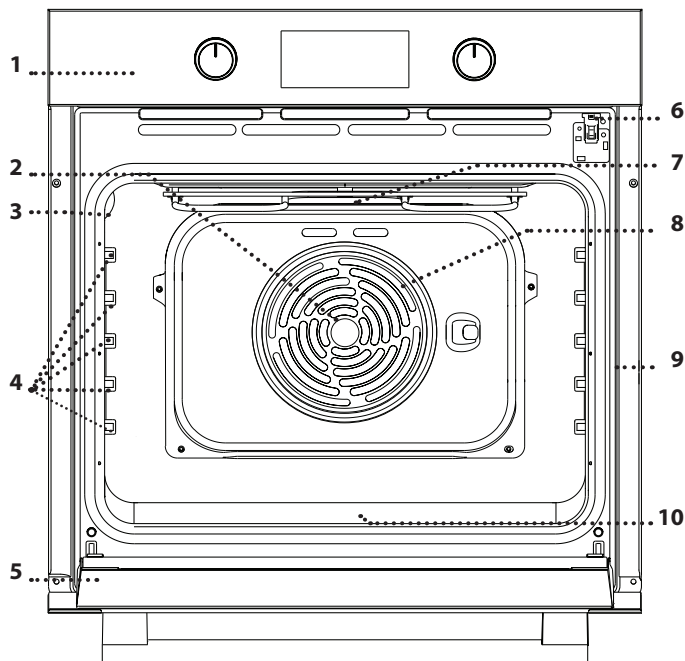

1. Pannello dei comandi
2. Ventola
3. Luce
4. Griglie laterali (il livello è indicato sulla parete della cavità)
5. Porta
6. Blocco serratura (blocca la porta durante e dopo la pulizia automatica)
7. Resistenza superiore/grill
8. Resistenza circolare (non visibile)
9. Targhetta matricola (da non rimuovere)
10. Cavità **STEAM** per l'acqua potabile

DESCRIZIONE DEL PANNELLO COMANDI

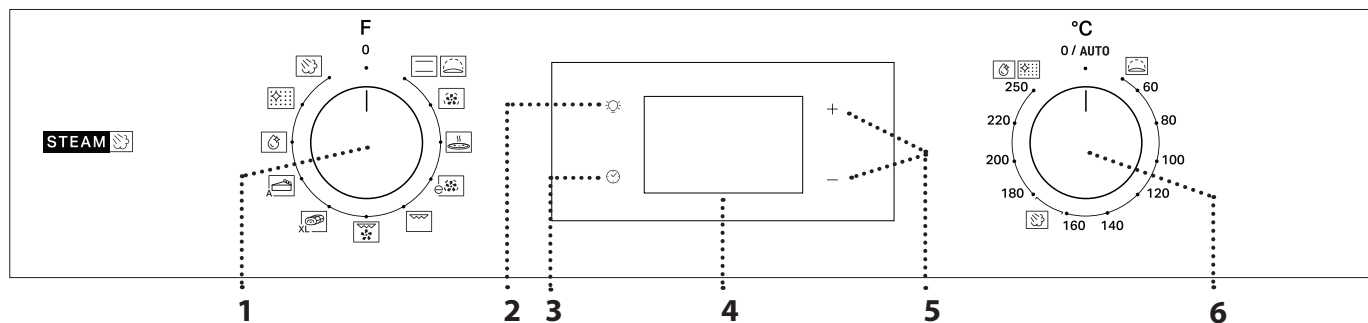

1. MANOPOLA DI SELEZIONE

Per accendere il forno selezionando una funzione. Per spegnere il forno, ruotare sulla posizione 0.

2. LAMPADA

A forno acceso, premere per accendere o spegnere la luce interna del forno.

3. IMPOSTARE L'ORA

Per accedere alle impostazioni della durata di cottura, dell'avvio ritardato e del timer.

A forno spento, per visualizzare l'ora.

4. DISPLAY

5. TASTI DI REGOLAZIONE
Per modificare le impostazioni di durata.

6. MANOPOLA TERMOSTATO

Ruotare per selezionare la temperatura desiderata attivando le funzioni manuali.

Note: Il tipo di manopola può variare a seconda del modello. Se le manopole sono attivate a pressione, spingere verso il basso il centro della manopola per sbloccarla dalla relativa sede.

ACCESSORI

GRIGLIA

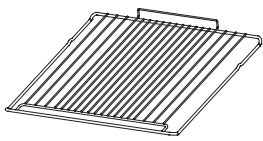

Utilizzare per cuocere gli alimenti o come supporto per teglie, tortiere e altre pentole da forno.

LECCARDA*

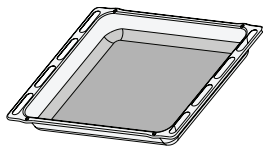

Utilizzare come teglia da forno per cucinare carne, pesce, verdure, focacce, ecc. o posizionare sotto la griglia per raccogliere i succhi di cottura.

PIASTRA DOLCI *



Utilizzare per la cottura di tutti i prodotti di panetteria e pasticceria, ma anche per arrostiti, pesce en papillote, ecc.

GUIDE DI SCORRIMENTO *

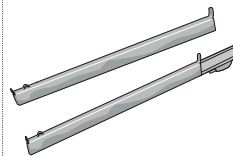

Per facilitare l'inserimento o la rimozione degli accessori.

* Disponibile solo su alcuni modelli

Il numero e il tipo di accessori possono variare a seconda del modello acquistato.

È possibile acquistare separatamente altri accessori presso il Servizio Assistenza Tecnica.

INSERIRE LA GRIGLIA E ALTRI ACCESSORI

Inserire la griglia tenendola leggermente inclinata verso l'alto, appoggiando dapprima il lato posteriore rialzato - orientato verso l'alto - sul livello desiderato.

In seguito, farla scivolare orizzontalmente sulle guide fino a fine corsa.

Gli altri accessori, per esempio la teglia, vanno inseriti orizzontalmente facendoli scivolare sulle guide.

GRIGLIE SCORREVOLI E GUIDE LATERALI

Prima di utilizzare il forno rimuovere il nastro di protezione [a] e successivamente rimuovere la pellicola protettiva [b] dalle guide di scorrimento.

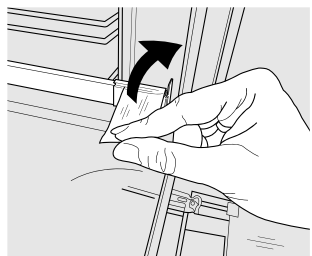

[a]

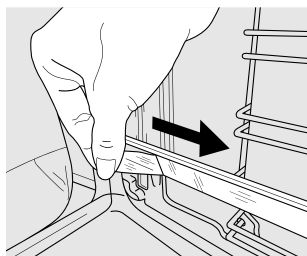

[b]

RIMOZIONE DELLE GUIDE DI SCORRIMENTO [c]

Tirare la parte inferiore della guida di scorrimento per sganciare i ganci inferiori (1) e tirare le guide di scorrimento verso l'alto, rimuovendole dai ganci superiori (2).

RIMONTAGGIO DELLE GUIDE DI SCORRIMENTO [d]

Agganciare i ganci superiori alle guide dei ripiani (1), quindi premere la parte inferiore delle guide di scorrimento contro le guide dei ripiani, fino a far scattare i ganci inferiori (2).

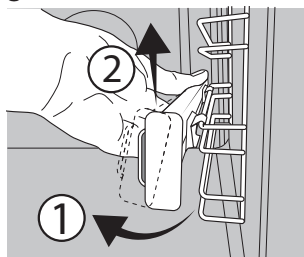

[c]

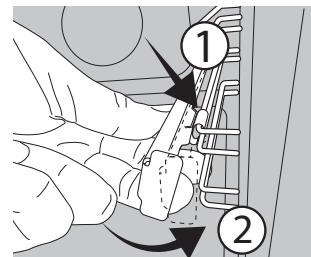

[d]

TOGLIERE E RIMONTARE LE GRIGLIE LATERALI

1. Per rimuovere le griglie laterali, impugnare la parte esterna della griglia e tirarla verso di sé per estrarre il supporto e i due perni interni dai rispettivi alloggiamenti.
2. Per riapplicare le griglie laterali, posizzarle vicino alla parete interna del forno e inserire dapprima i due perni nei rispettivi alloggiamenti. Posizionare quindi la parte esterna vicino alla sua sede, inserire il supporto e spingere con decisione verso la parete del forno per fissare saldamente la griglia.

FUNCTIONS (FUNZIONI)

STATICO

Per cuocere qualsiasi tipo di pietanza su un solo ripiano.

LIEVITAZIONE

Per agevolare la lievitazione di impasti dolci o salati. Per attivare questa funzione, ruotare la *manopola del termostato* sull'icona corrispondente.

TERMOVENTILATO

Per cuocere contemporaneamente su più ripiani (massimo tre) alimenti diversi che richiedono la medesima temperatura di cottura. Questa funzione permette di eseguire la cottura senza trasmissione di odori da un alimento all'altro.

PIZZA

Per cuocere diversi tipi e formati di pizza e focaccia. Si consiglia di invertire la posizione delle teglie a metà cottura.

ECO TERMOVENTILATO

Per cuocere arrostiti e arrostiti ripieni su uno stesso ripiano. La circolazione intermittente dell'aria impedisce un'eccessiva asciugatura degli alimenti.

In questa funzione ECO la luce rimane spenta durante la cottura e può essere riaccesa premendo .

GRILL

Per grigliare bistecche, spiedini e salsicce, cucinare verdure gratinate o tostare il pane. Quando si griglia la carne, si consiglia di utilizzare una leccarda per raccogliere i succhi di cottura: posizionarla un livello sotto la griglia e aggiungere 200 ml di acqua potabile.

TURBO GRILL

Per arrostiti grandi tagli di carne (cosce, arrosto di manzo, pollo). Si consiglia di utilizzare una leccarda per raccogliere i succhi di cottura: posizionarla un livello sotto la griglia e aggiungere 200 ml di acqua potabile.

MAXI COOKING

Per cuocere tagli di carne di grosse dimensioni (superiori ai 2,5 kg). Si raccomanda di girare la carne

durante la cottura per farla rosolare su tutti i lati. Si consiglia inoltre di irrorare la carne di tanto in tanto per evitare che asciughi eccessivamente.

PASTRY AUTO (DOLCI AUTO)

Questa funzione seleziona automaticamente temperatura e tempo ideali per la cottura dei dolci. Attivare la funzione a forno freddo.

STEAM+

La funzione Steam+ permette di ottenere ottime prestazioni grazie alla presenza di vapore nel ciclo di cottura. Questa funzione gestisce automaticamente la temperatura ideale per la cottura di un'ampia gamma di ricette; i tempi di cottura dei piatti principali sono indicati nella relativa tabella di cottura. Attivare sempre la funzione vapore quando il forno è freddo e dopo aver versato 200 ml di acqua potabile sul fondo della cavità. Per attivare la funzione Steam+, è necessario ruotare la manopola del termostato nella posizione dell'icona .

FLEXI CLEAN PACK

SMARTCLEAN



L'azione del vapore rilasciato durante questo speciale ciclo di pulizia a bassa temperatura permette di rimuovere facilmente sporco e residui di cibo. Per attivare la funzione "Smart clean", dopo aver versato 100 -120 ml di acqua potabile sul fondo della cavità del forno, ruotare la manopola di selezione e la manopola termostato in corrispondenza dell'icona . Si consiglia di utilizzare la funzione per 35'. Attivare la funzione a forno freddo. La posizione dell'icona non corrisponde alla temperatura raggiunta durante il ciclo di pulizia.

AUTOMATIC CLEANING - PYRO (PULIZIA AUTOMATICA - PIROLISI)



Per eliminare gli schizzi dovuti alla cottura attraverso un ciclo a temperatura molto elevata. Per attivare questa funzione, portare la manopola del termostato su . La posizione dell'icona non corrisponde alla temperatura reale raggiunta durante il ciclo di pulizia.

PRIMO UTILIZZO

1. IMPOSTARE L'ORA

Alla prima accensione, è necessario impostare l'ora: premere  finché sul display lampeggiano l'icona  e le due cifre relative all'ora.



Utilizzare + o - per impostare l'ora e premere  per confermare. Le due cifre dei minuti iniziano a lampeggiare. Utilizzare + o - per impostare l'ora e premere  per confermare.

Note: quando l'icona  lampeggia, ad esempio dopo una prolungata interruzione di corrente, è necessario impostare l'ora.

2. IMPOSTARE L'ASSORBIMENTO DI POTENZA

Di default, il forno è programmato per funzionare a una potenza superiore a 3 kW (Hi). Per far funzionare il forno a una potenza compatibile con un'alimentazione domestica inferiore a 2,9 kW (Lo), è necessario modificare le impostazioni.

Per accedere al menu di modifica, ruotare la *manopola di selezione* su , quindi riportarla su 0.

Subito dopo, premere + e - per cinque secondi.



Utilizzare + o - per modificare l'impostazione, quindi tenere premuto  per almeno due secondi per confermare.

3. RISCALDAMENTO DEL FORNO

Un nuovo forno può rilasciare degli odori dovuti alla lavorazione di fabbrica: questo è normale. Prima di cucinare gli alimenti è dunque raccomandato di riscaldare a vuoto il forno per rimuovere ogni odore.

Rimuovere protezioni di cartone o pellicole trasparenti e togliere gli accessori dal forno.

Riscaldare il forno a 250 °C per circa un'ora. Durante questa procedura il forno deve essere vuoto.

Note: Si consiglia di arieggiare il locale dopo il primo utilizzo dell'apparecchio.

USO QUOTIDIANO

1. SELEZIONARE UNA FUNZIONE

Per selezionare una funzione, ruotare la *manopola di selezione* in corrispondenza del simbolo per la funzione desiderata: il display si accende e il forno emette un segnale acustico.



2. AVVIARE UNA FUNZIONE

MANUAL (MANUALE)

Per avviare la funzione selezionata, ruotare la *manopola termostato* per impostare la temperatura desiderata.



Nota: durante la cottura sarà possibile modificare la funzione ruotando la manopola di selezione o regolare la temperatura ruotando la manopola termostato. La funzione non si avvia se la manopola del termostato si trova sulla posizione **O / AUTO** (ad eccezione della funzione PASTRY AUTO). Sarà possibile impostare la durata, l'ora di fine cottura (solo se è impostata una durata) e il timer.

LIEVITAZIONE

Per avviare la funzione "Lievitazione", ruotare la *manopola del termostato* in posizione Lievitazione (40 gradi) e portare la manopola di funzione in posizione Statico; se il forno è impostato su una temperatura diversa, la funzione non si avvia.

Note: Sarà possibile impostare la durata, l'ora di fine cottura (solo se è impostata una durata) e il timer.

STEAM

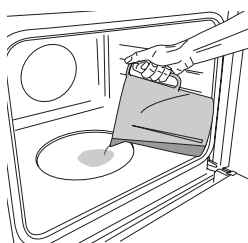



Per avviare la funzione Steam, versare 200 ml di acqua potabile sul fondo del forno. Selezionare la funzione ruotando in senso orario la manopola di selezione sull'icona corrispondente e la manopola del termostato in qualsiasi posizione tra 160 e 180°C (come suggerito dall'icona). La

funzione si avvia e il display mostra l'ora corrente del giorno. Non è necessario alcun preriscaldamento. Per terminare la cottura, ruotare la manopola di selezione sulla posizione "0". Durante la cottura a vapore, non aprire mai la porta e non rabboccare l'acqua.

Note: L'apertura della porta e il rabbocco dell'acqua durante la cottura possono avere effetti negativi sul risultato finale della cottura.

3. PRERISCALDAMENTO E CALORE RESIDUO

Una volta avviata la funzione, un segnale acustico e l'icona  lampeggiante sul display segnalano che si è attivata la fase di preriscaldamento. Al termine di questa fase, un segnale acustico e l'icona  fissa sul display indicheranno che il forno ha raggiunto la temperatura impostata: a questo punto, posizionare gli alimenti all'interno e procedere con la cottura.

Note: inserire gli alimenti nel forno prima della fine del preriscaldamento può compromettere i risultati di cottura.



Al termine della cottura e con la funzione disattivata, è possibile che l'icona  rimanga visibile sul display per indicare la presenza di calore residuo.

Note: il tempo di spegnimento dell'icona può variare perché dipende da una serie di fattori, come la temperatura ambiente e la funzione utilizzata. In ogni caso, il prodotto può essere considerato spento quando il puntatore della manopola di selezione si trova su "0".

4. PROGRAMMAZIONE DELLA COTTURA

Per programmare la cottura è necessario aver selezionato precedentemente una funzione.



DURATION (DURATA)

Premere  tante volte fino a che sul display lampeggiano l'icona  e "00:00".





Utilizzare + o - per impostare il tempo di cottura desiderato, quindi premere  per confermare.

Attivare la funzione ruotando la *manopola termostato* in corrispondenza della temperatura desiderata o necessaria: un segnale acustico e il display avviseranno del termine della cottura.

Note: Per annullare la durata impostata, premere  tante volte fino a che sul display lampeggia l'icona , quindi utilizzare - per riportare la durata a "00:00". La durata impostata include la fase di preriscaldamento.

PROGRAMMING THE END COOKING TIME/DELAYED START (PROGRAMMARE L'ORA DI FINE COTTURA/AVVIO RITARDATO)

Una volta impostata una durata sarà possibile posticipare l'avvio della funzione, programmandone l'ora di fine: premere  fino a che sul display non lampeggiano l'icona  e l'ora corrente.

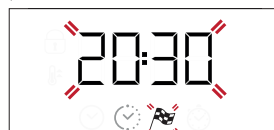

Utilizzare + o - per impostare l'ora in cui desidera terminare la cottura e premere  per confermare.

Attivare la funzione ruotando la *manopola termostato* in corrispondenza della temperatura desiderata o necessaria: la funzione resterà in pausa fino ad avviarsi automaticamente dopo un periodo di tempo calcolato per terminare la cottura all'orario impostato.

Note: per annullare l'impostazione, spegnere il forno ruotando la *manopola di selezione* sulla posizione 0.

La funzionalità di ritardo di avvio non è disponibile per le funzioni Grill e Turbo Grill.

END OF COOKING (FINE COTTURA)

Un segnale acustico e il display avvisano del termine della funzione.





Ruotare la *manopola di selezione* per selezionare una funzione differente o portarla su 0 per spegnere il forno.

Note: se attivo il timer, il display mostrerà la scritta "END" in alternanza al tempo rimanente.



5. IMPOSTAZIONE DEL TIMER

Questa opzione non interrompe né programma la cottura ma permette di utilizzare il display come contaminuti, sia durante una funzione attiva che quando il forno è spento.

Tenere premuto  fino a quando l'icona  e "00:00" e "00:00" iniziano a lampeggiare sul display.



Utilizzare + o - per impostare l'ora desiderata e premere  per confermare. Un segnale acustico avviserà del termine del conto alla rovescia.

Note: per disattivare il timer, premere  tante volte fino a che l'icona  lampeggia, quindi utilizzare - per riportare la durata a "00:00".

6. FUNZIONE DI PULIZIA AUTOMATICA - PIROLISI

Non toccare il forno durante il ciclo di pirolisi. Tenere i bambini e gli animali lontani dal forno durante e dopo (fino a una completa areazione della stanza) il ciclo di pirolisi.

Prima di attivare la funzione rimuovere tutti gli accessori dal forno, comprese le guide laterali. Se il forno è installato sotto un piano di cottura, accertarsi che durante il ciclo di pulizia automatica i bruciatori o le piastre elettriche siano spente.

Per ottenere risultati di pulizia ottimali, eliminare i depositi di grandi dimensioni con una spugna umida prima di avviare la funzione di pirolisi.

Non avviare il ciclo di pulizia pirolitica se il forno presenta residui di calcare.

Si consiglia di attivare la funzione di pirolisi soltanto se l'apparecchio è molto sporco o emana cattivi odori durante la cottura.

Per attivare la funzione di pulizia automatica, ruotare la *manopola di selezione* e la *manopola del termostato* sull'icona . La funzione si attiverà automaticamente, la porta sarà bloccata e la luce interna del forno sarà spenta: il display mostrerà il tempo rimanente, alternato alla scritta "Pyro".



A ciclo ultimato, la porta rimane bloccata fino a quando non viene raggiunta una temperatura sicura. Ventilare la stanza durante e dopo il ciclo di pirolisi.

TABELLA DI COTTURA

RICETTA	FUNZIONE	PRERISC.	TEMPERATURA (°C)	DURATA (Min)	LIVELLO E ACCESSORI
Leavened cakes (Torte lievitate)		Sì	170	30 - 50	
		Sì	160	30 - 50	
		Sì	160	40 - 60	
Torte ripiene (cheese cake, strudel, torte di frutta)		Sì	160 - 200	35 - 90	
		Sì	160 - 200	40 - 90	
Biscuits / tartlets (Biscotti/Tortine)		Sì	160	25 - 35	
		Sì	160	25 - 35	
		Sì	150	35 - 45	
Choux buns (Bigné)		Sì	180 - 210	30 - 40	
		Sì	180 - 200	35 - 45	
		Sì	180 - 200	35 - 45	
Meringues (Meringhe)		Sì	90	150 - 200	
		Sì	90	140 - 200	
		Sì	90	140 - 200	
Pizza/Focaccia		Sì	190 - 250	15 - 50	
		Sì	190 - 250	20 - 50	
Frozen pizza (Pizza surgelata)		Sì	250	10 - 20	
		Sì	230-250	10 - 25	
Torte salate (torte di verdura, quiche)		Sì	180 - 200	40 - 55	
		Sì	180 - 200	45 - 60	
		Sì	180 - 200	45 - 60	
Vols-au-vents / puff pastry crackers (Vol-au-vent / Salatini di pasta sfoglia)		Sì	190 - 200	20 - 30	
		Sì	180 - 190	20 - 40	
		Sì	180 - 190	20 - 40	
Lasagne / Pasta al forno / Cannelloni / Sfornati		Sì	190 - 200	45 - 65	
Lamb / veal / beef / pork (Agnello / Vitello / Manzo / Maiale) 1 kg		Sì	190 - 200	80 - 110	
Maiale arrosto with crackling (con cotenna) 2 kg		Sì	180 - 190	110 - 150	
Pollo / Coniglio / Anatra 1 kg		Sì	200 - 230	50 - 100	
Turkey / goose (Tacchino / Oca) 3 kg		-	190 - 200	100 - 160	
Baked fish / en papillote (fillets, whole) (Pesce al forno / al cartoccio (filetti, intero))		Sì	170 - 190	30 - 45	
Verdure ripiene (pomodori, courgettes (zucchine), aubergines (melanzane))		Sì	180 - 200	50 - 70	
Toasted bread (Pane tostato)		5'	250	2 - 6	

ACCESSORI					
	Griglia	Recipiente su griglia	Teglia / Leccarda o teglia su griglia	Leccarda / Teglia	Leccarda / teglia con 200 ml d'acqua

FUNCTIONS (FUNZIONI)						
	Statico	Termoventilato	Pizza	Grill	Turbo Grill	Eco termoventilato

RICETTA	FUNZIONE	PRERISC.	TEMPERATURA (°C)	DURATA (Min)	LIVELLO E ACCESSORI
Fish fillets / slices (Filetti / tranci di pesce)		-	230 - 250	15 - 30 *	4 3
Salsicce / Spiedini / Costine / Hamburger		-	250	15 - 30 *	5 4
Pollo arrosto 1-1,3 kg		Sì	200 - 220	55 - 70 **	2 1
Roast beef rare (Roast beef al sangue) 1 kg		Sì	200 - 210	35 - 50 **	3
Leg of lamb / knuckle (Cosciotto di agnello / Stinchi)		Sì	200 - 210	60 - 90 **	3
Patate arrosto		Sì	200 - 210	35 - 55	2
Vegetable gratin (Verdure gratinate)		-	200 - 210	25 - 55	3
Meat and potatoes (Carne & Patate)		Sì	190 - 200	45 - 100 ***	4 1
Fish and vegetables (Pesce & Verdure)		Sì	180	30 - 50 ***	4 2
Lasagne and meat (Lasagne e carne)		Sì	200	50 - 100 ***	4 1
Pasto completo: Crostata di frutta (Liv. 5) / Lasagne (Liv. 3) / Carne (Liv. 1)		Sì	180 - 190	40 - 120 ***	5 3 1
Roast meat / stuffed roasting joints (Arrosti / Arrosti ripieni)		-	170 - 180	100 - 150	3

* Ruotare il cibo a metà cottura

** Girare gli alimenti a due terzi di cottura (se necessario).

*** Tempo di cottura approssimativo: i piatti possono essere estratti dal forno in momenti diversi, a seconda delle preferenze personali.



TABELLA DI COTTURA STEAM+

ALIMENTO	RICETTA	QUANTITÀ	tempo (min)	ACCESSORI	LIVELLO	ACQUA
 PANE	Pane piccolo	80-100 g	30 - 45		2	 200 ml
	Pane in cassetta	300-500 g	40 - 60			
	Pane	500g-2 kg	50 - 100			
	Baguette	200-300 g	30 - 45			
 CARNE	Arrosto	1 kg	60 - 110			
	Costine	500g-1,5 kg	50 - 75			
	Pollo	1-1,5 kg	55 - 80			
	Pollo/tacchino	3 kg	100 - 140			
 PESCE	Bistecca di manzo	0,5-2 cm	15 - 25			
	Bistecca di manzo	2-4 cm	20 - 35			
	Pesce intero	300 - 600 g	20 - 30			
	Pesce intero	600 - 1200 g	25 - 45			
 VERDURE	Patate al vapore	0,5-1,5 kg	45 - 60			
	Peperoni ripieni	1-2 kg	35 - 55			
	Broccoli al vapore	0,3-1 kg	30 - 50			
	Zucchine al vapore	0,5-1,5 kg	30 - 50			
 PASTICCERIA	Biscotti	un vassoio	25 - 35			
	Muffin	30-60 g	25 - 45			
	Pan di spagna	500-700 g	30 - 50			
	Crostata	un barattolo	35 - 55			

Attivare la funzione STEAM+ a forno freddo. L'apertura della porta e il rabbocco dell'acqua durante la cottura possono avere effetti negativi sul risultato finale della cottura.

ACCESSORI					
	Griglia	Recipiente su griglia	Teglia / Leccarda o teglia su griglia	Leccarda / Teglia	Leccarda / teglia con 200 ml d'acqua

FUNCTIONS (FUNZIONI)						
	Statico	Termoventilato	Pizza	Grill	Turbo Grill	Eco termoventilato

PULIZIA E MANUTENZIONE

Assicurarsi che il forno si sia raffreddato prima di effettuare qualsiasi intervento di manutenzione o pulizia.

Non utilizzare pulitori a vapore.

Non utilizzare lana metallica, pagliette abrasive o detersivi abrasivi/corrosivi, perché potrebbero danneggiare le superfici dell'apparecchio.

Indossare guanti protettivi.

Il forno deve essere scollegato dalla rete elettrica prima di effettuare qualsiasi tipo di manutenzione.

SUPERFICI ESTERNE

Pulire le superfici con un panno in microfibra umido. Se molto sporche, aggiungere qualche goccia di detersivo con pH neutro. Asciugare con un panno.

Non utilizzare detersivi corrosivi o abrasivi. Se inavvertitamente uno di questi prodotti dovesse venire a contatto con le superfici, pulire subito con un panno in microfibra umido.

SUPERFICI INTERNE

• Dopo ogni uso, lasciare raffreddare il forno e pulirlo preferibilmente quando è ancora tiepido per rimuovere incrostazioni e macchie dovute a residui di cibo. Per asciugare la condensa dovuta alla cottura di alimenti con un elevato contenuto di acqua, usare a forno freddo un panno o una spugna.

• Per rimuovere il calcare rimasto sulla base del forno dopo un ciclo di cottura **STEAM**, si consiglia di pulire la cavità

con i prodotti disponibili presso il Servizio Assistenza (seguire le istruzioni allegate al prodotto).

Si raccomanda di eseguire la pulizia almeno ogni 5-10 cicli di cottura **STEAM**.

• In caso di sporco tenace sulle superfici interne, si raccomanda di utilizzare la funzione di pulizia automatica. Non avviare il ciclo di pulizia pirolitica se il forno presenta residui di calcare. Pulire prima i residui di calcare come descritto in precedenza.

• Per facilitare la pulizia dei vetri è possibile rimuovere e smontare la porta.

• Pulire il vetro della porta con detersivi liquidi specifici.

ACCESSORI

Mettere a bagno gli accessori con detersivo per piatti dopo l'uso, maneggiandoli con guanti da forno, se ancora caldi. I residui di cibo possono essere rimossi con una spazzola per piatti o con una spugna.

RIMOZIONE E RIMONTAGGIO DELLA PORTA

1. Per rimuovere la porta, aprirla completamente e abbassare i fermi fino alla posizione di sblocco.

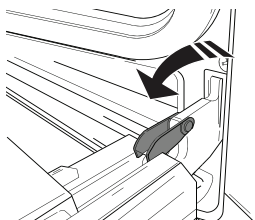

2. Chiudere la porta fino a quando è possibile.

Prendere saldamente la porta con entrambe le mani, evitando di tenerla per la maniglia. Per estrarla facilmente, continuare a chiuderla e contemporaneamente tirarla verso l'alto (a) finché non esce dalle sedi (b).

Togliere la porta e appoggiarla su un piano morbido.

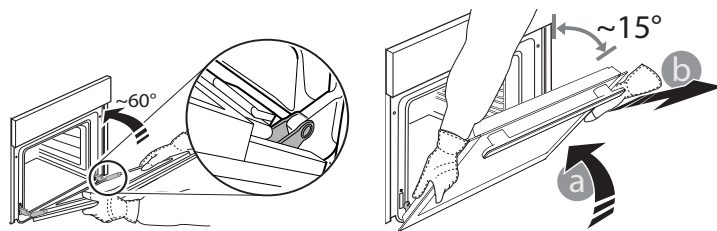

3. Per rimontare la porta, avvicinarla al forno allineando i ganci delle cerniere alle proprie sedi e ancorare la parte superiore agli alloggiamenti.

4. Abbassare la porta e poi aprirla completamente. Abbassare i fermi nella posizione originale: fare attenzione che siano completamente abbassati.

5. Provare a chiudere la porta, verificando che sia allineata al pannello di controllo. Se non lo fosse, ripetere tutte le operazioni.

SOSTITUZIONE DELLA LAMPADINA

1. Scollegare il forno dalla rete elettrica.

2. Svitare il coperchio dalla luce, sostituire la lampadina e riavvitare il coperchio sulla luce.

3. Ricollegare il forno alla rete elettrica.

Note: Utilizzare lampadine alogene da 25 W/230 V di tipo G9, T300 °C. La lampadina utilizzata nel prodotto è progettata specificamente per gli apparecchi domestici e non è adatta all'illuminazione generale degli ambienti domestici (Regolamento CE 244/2009).

Le lampade sono disponibili presso il Servizio Assistenza Tecnica. - Non maneggiare le lampadine a mani nude, perché le impronte digitali potrebbero danneggiarle. Non far funzionare il forno senza prima aver riposizionato il coperchio.

PULIZIA DEI VETRI DELLA PORTA

1. Dopo aver smontato la porta e averla appoggiata su un ripiano morbido con la maniglia verso il basso, premere contemporaneamente le due clip di fissaggio ed estrarre il profilo superiore della porta tirandolo verso di sé.

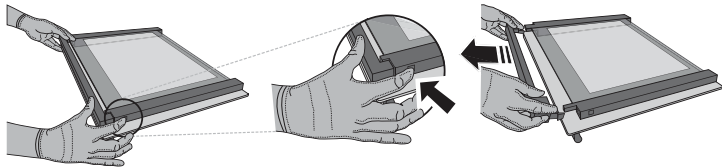

2. Sollevare e prendere saldamente il vetro interno con due mani, rimuoverlo e appoggiarlo su un piano morbido prima di eseguire la pulizia.

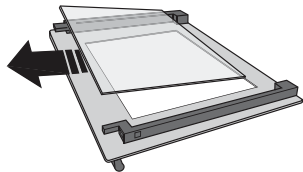

3. Prima di rimontare il vetro interno è necessario riapplicare il vetro intermedio (contrassegnato con "1R"): Per posizionare correttamente i vetri, verificare che la marcatura "R" sia visibile nell'angolo sinistro. Inserire dapprima il lato lungo del vetro contrassegnato con "R" nelle sedi di sostegno, quindi abbassarlo in posizione. Ripetere la procedura per entrambi i vetri.

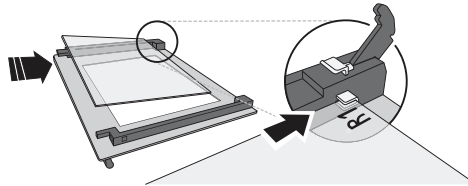

4. Rimontare il profilo superiore: Un clic indicherà il posizionamento corretto. Verificare che la tenuta sia salda prima di rimontare la porta.

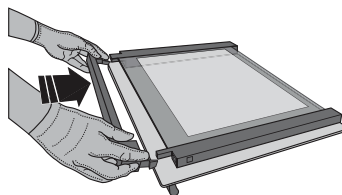

RISOLUZIONE DEI PROBLEMI

PROBLEMA	POSSIBILE CAUSA	SOLUZIONE
Il forno non funziona.	Interruzione di corrente elettrica. Disconnessione dalla rete principale.	Verificare che ci sia tensione in rete e che il forno sia collegato all'alimentazione elettrica. Spegner e riaccendere il forno e verificare se l'inconveniente persiste.
Il display visualizza la lettera "F" seguita da un numero o da una lettera.	Guasto del forno.	Contattare il Servizio Assistenza Tecnica Clienti più vicino e indicare il numero che segue la lettera "F".
Il display visualizza il messaggio "Hot" (Caldo) e la funzione selezionata non si avvia.	Temperatura troppo alta.	Lasciar raffreddare il forno prima di attivare la funzione. Selezionare una funzione diversa.
Il display visualizza un testo poco chiaro e sembra essere guasto.	Un'altra lingua impostata.	Contatta il Servizio Assistenza Tecnica più vicino.

* Disponibile solo su alcuni modelli

Per le linee guida, la documentazione standard e altre informazioni sui prodotti:

- Utilizzare il codice QR sull'apparecchio
- Visitare il sito web docs.whirlpool.eu
- Oppure, **contattare il Servizio Assistenza Tecnica** (al numero di telefono riportato sul libretto di garanzia). Prima di contattare il Servizio Assistenza Clienti, prepararsi a fornire i codici riportati sulla targhetta matricola del prodotto.

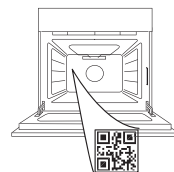

Whirlpool



400011705355