



CITY

60384





 **FR**
DONNEZ
OU
RECYCLEZ

 OU  OU 

ASSOCIATION MAGASIN DÉCHÈTERIE

Adresses sur quefairedemesdechets.fr



LEGO.com/sustainable-packaging



BUILDER



Apple and the Apple logo are trademarks of Apple Inc., registered in the U.S. and other countries and regions. App Store is a service mark of Apple Inc. Google Play and the Google Play logo are trademarks of Google LLC. Tencent and the Tencent logo are trademarks of Tencent Inc.

[LEGO.com/devicecheck](https://www.lego.com/devicecheck)

EN Ask parents' permission before going online | **DE** Eltern um Erlaubnis bitten, bevor du online gehst | **FR** Demande l'autorisation d'un parent avant d'aller en ligne | **IT** Chiedi il permesso ai tuoi genitori prima di andare online | **ES** Pídeles permiso a tus papás antes de conectarte a Internet | **PT** Pede autorização aos pais antes de acederes online | **JA** オンラインになる前に ほか者の方のきよかをもらおう | **ZH** 上网前应先征得父母的同意 | **KO** 온라인 접속 전에 보호자 동의가 필요합니다 | **RU** Спроси разрешения у родителей, прежде чем заходить в интернет | **PL** Poproś rodziców o zgodę, zanim wejdziesz do Internetu | **CS** Než půjdeš na internet, požádej rodiče o svolení | **SK** Skôr než pôjdeš na internet, vypýtaj si povolenie od rodičov | **HU** Kérj szülői engedélyt, mielőtt online csatlakoznál! | **RO** Cere permisiunea părinților înainte de a te conecta online | **BG** Поискайте разрешение от родител, преди да влезете онлайн | **LV** Pirms došanās tiešsaistē palūdz atļauju vecākiem | **ET** Enne Interneti kasutamist küsi vanematelt luba | **LT** Prieš prisijungdami prie interneto, atsklauskite tėvų



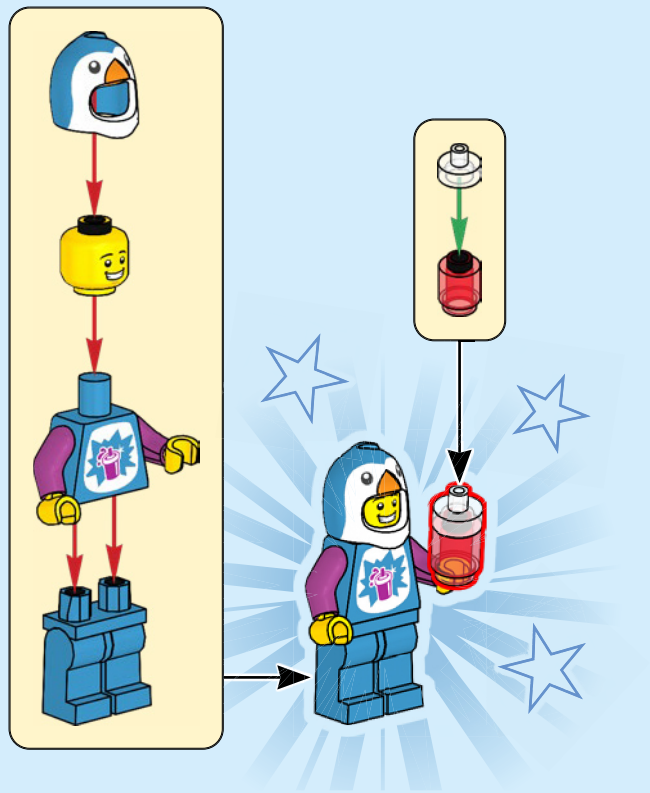

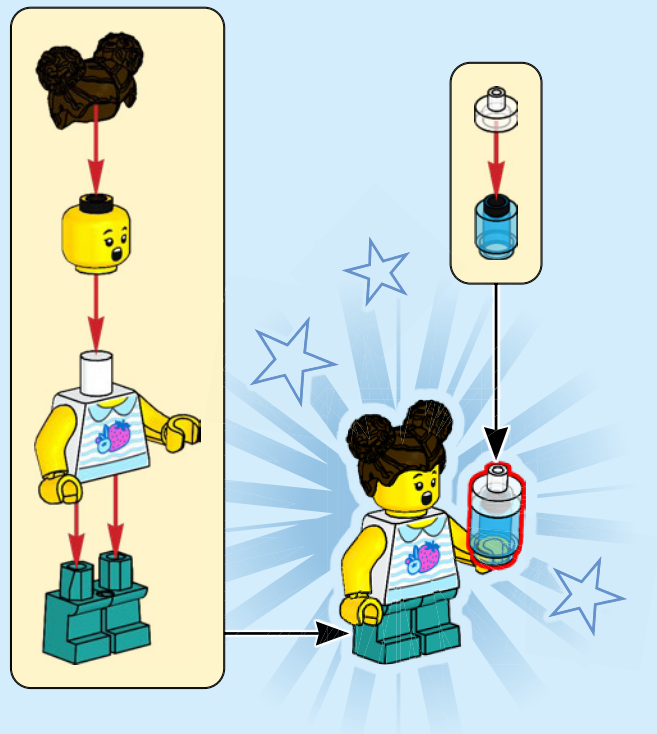

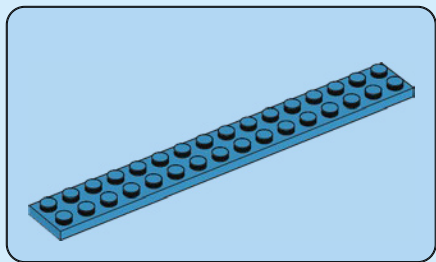

1

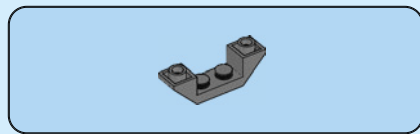
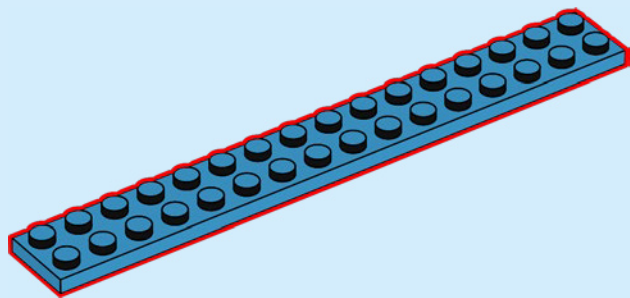

2

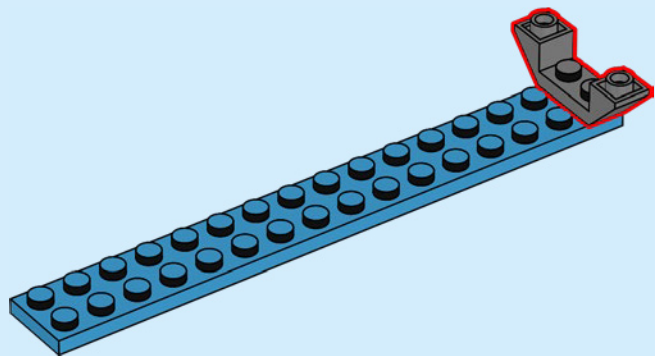

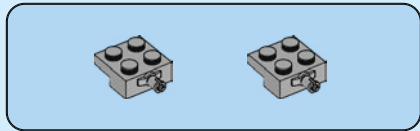

3

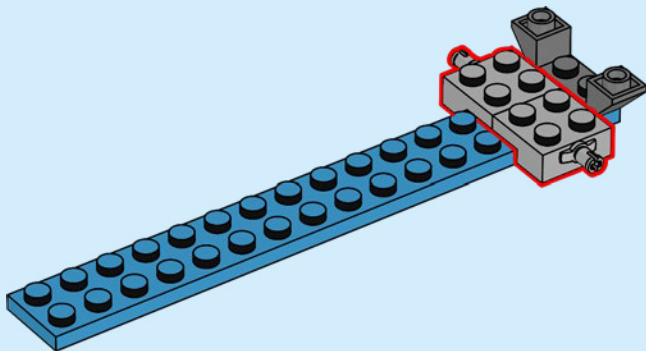

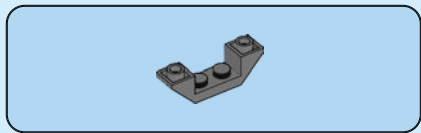

4

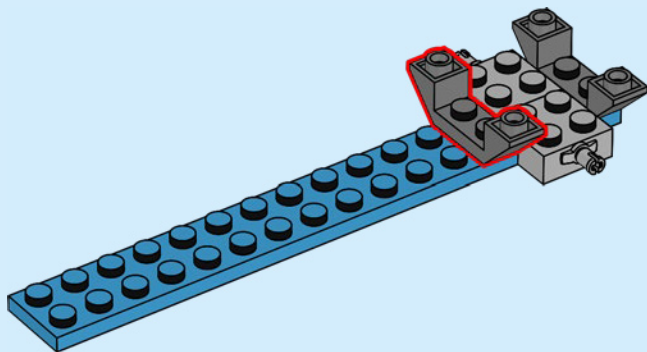

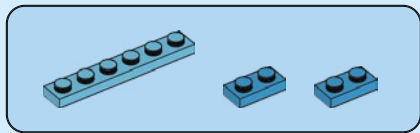

5

1

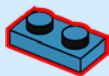

2

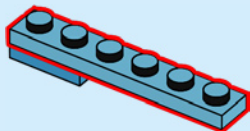

3

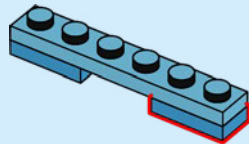

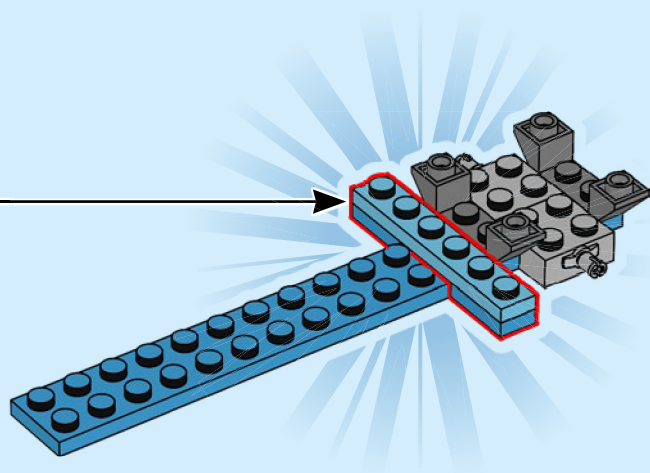

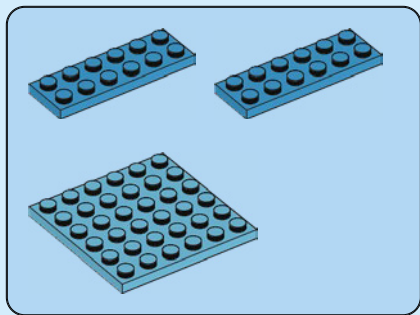

6

1

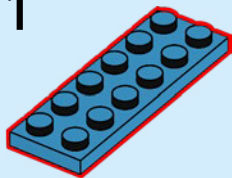

2

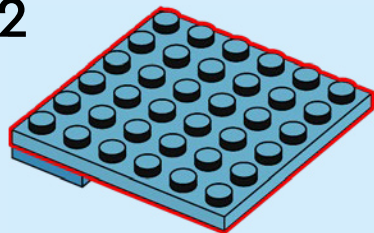

3

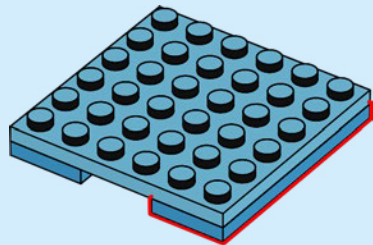

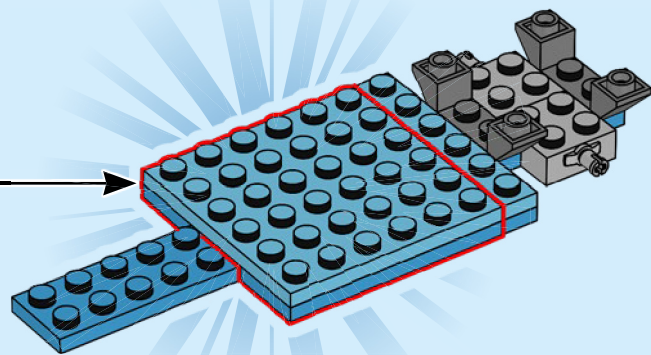

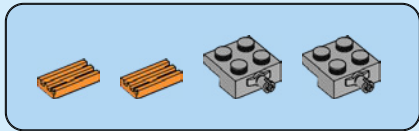

7

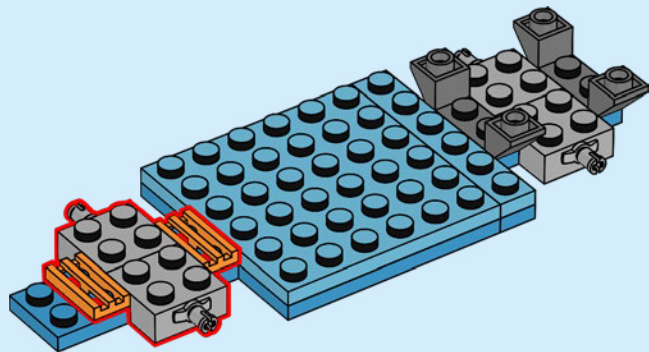

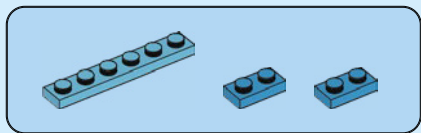

8

1



2

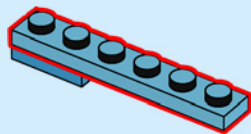

3

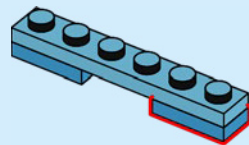

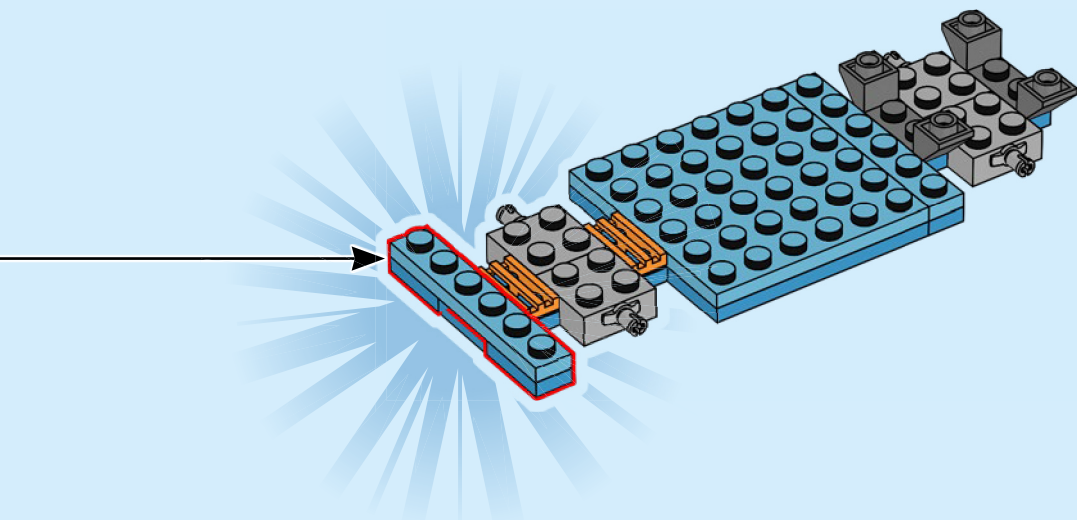

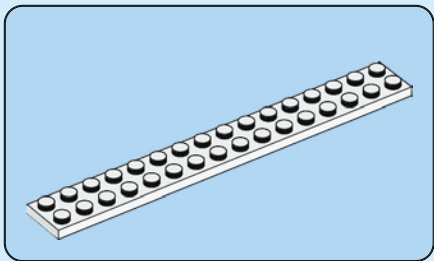

9

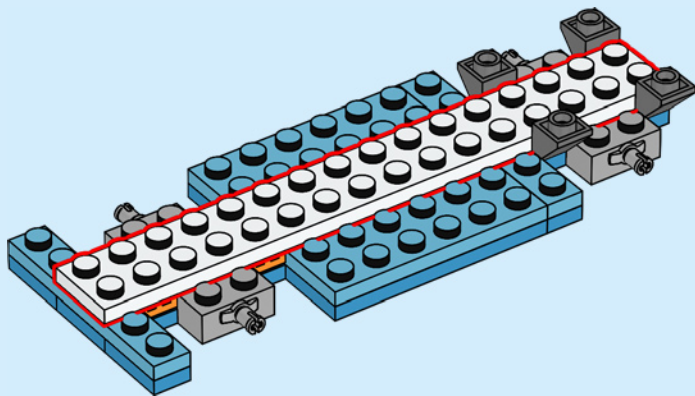



10

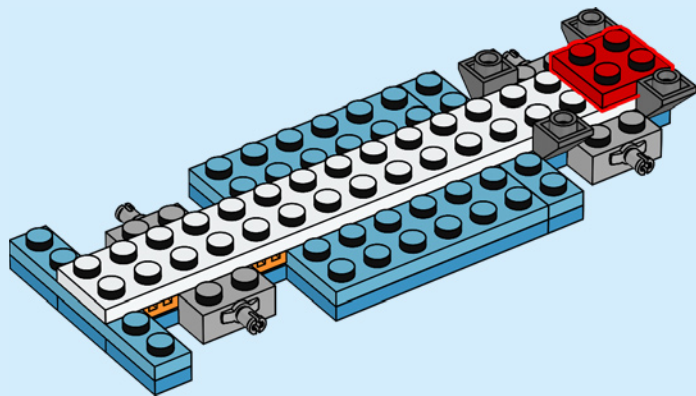

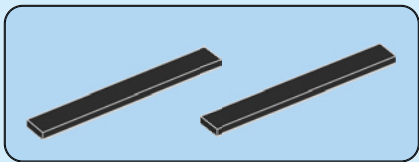

11

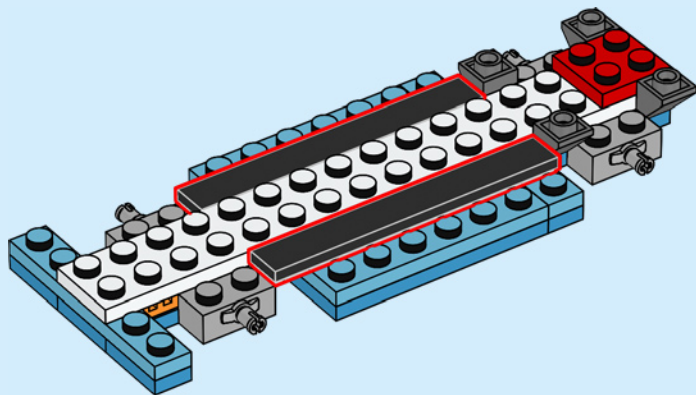

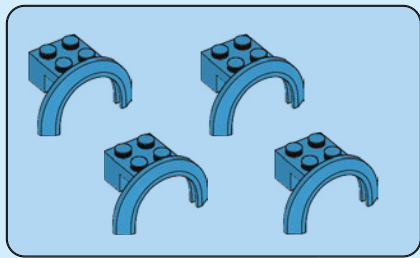

12

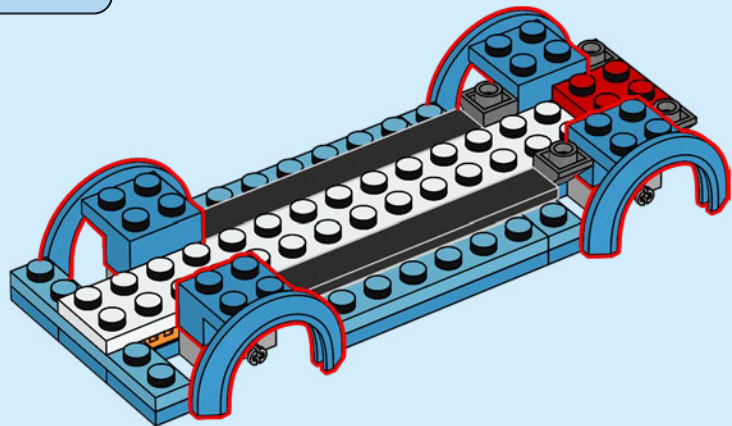

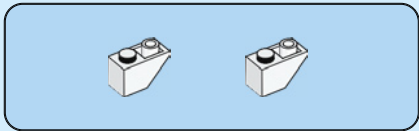

13

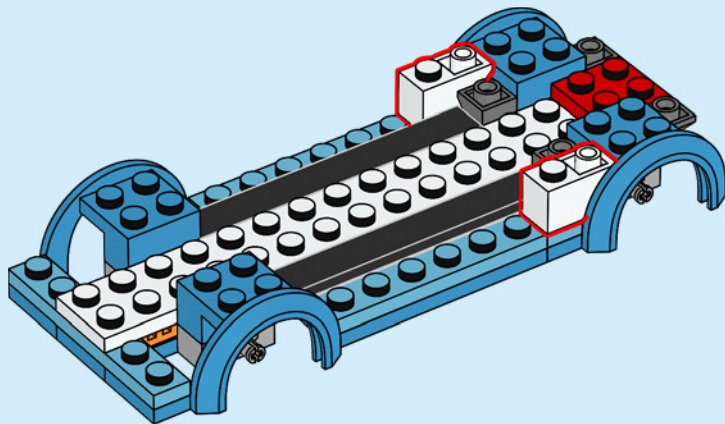

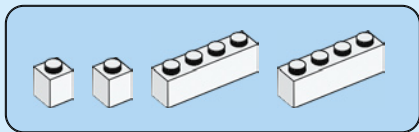

14

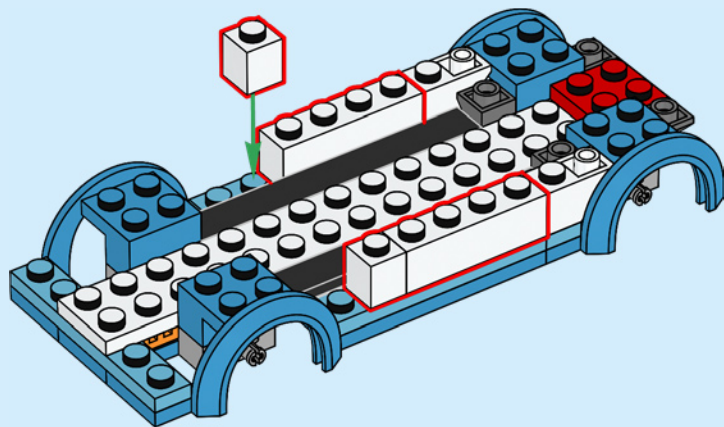

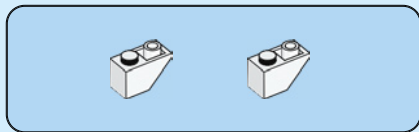

15

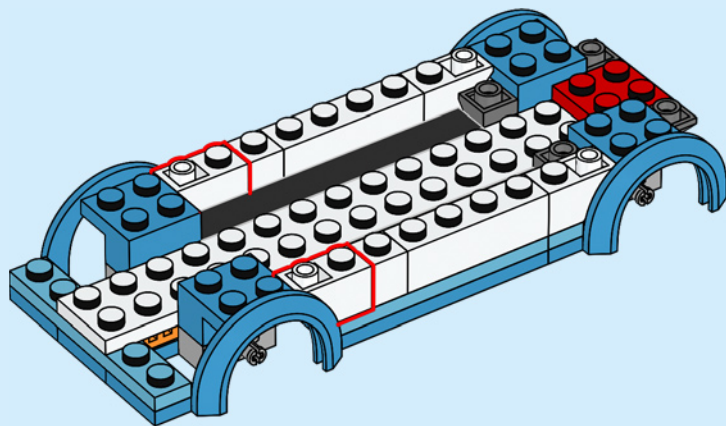

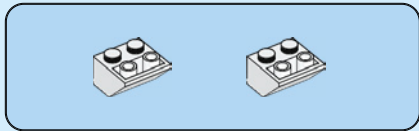

16

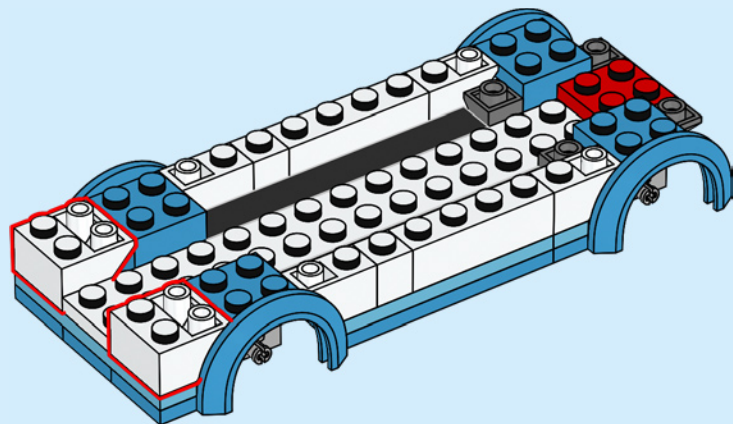

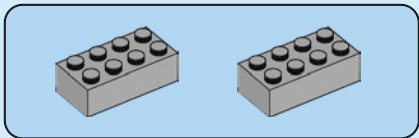

17

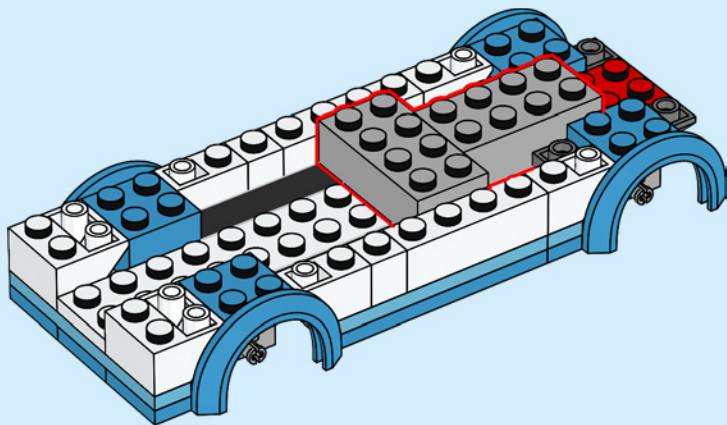

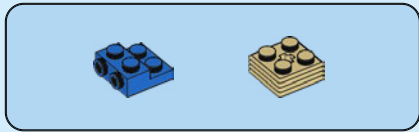

18

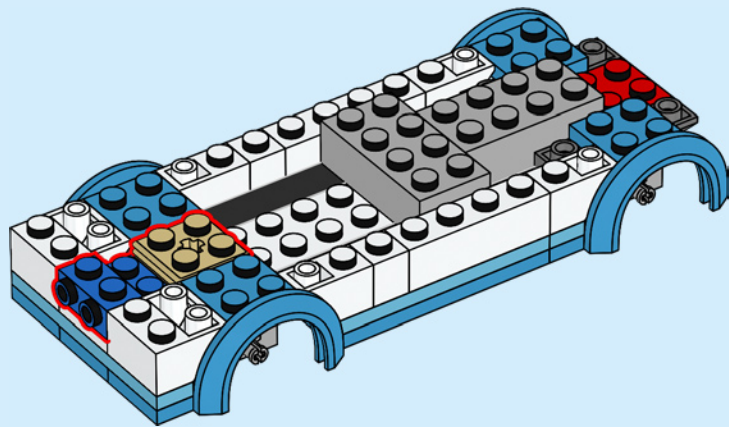

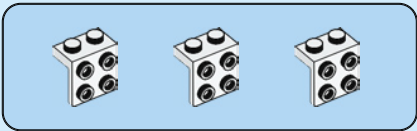

19

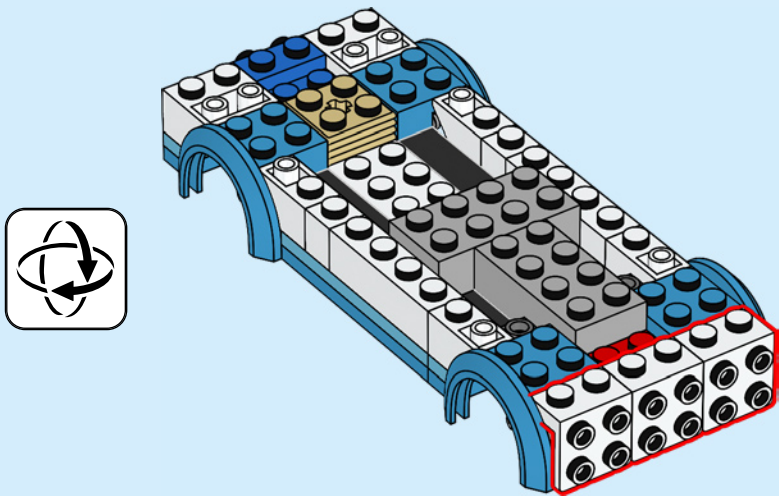

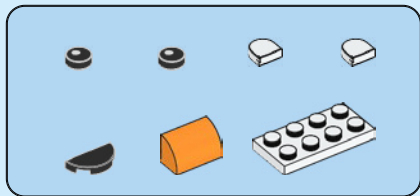

20

1



2



3

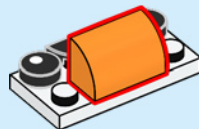

4

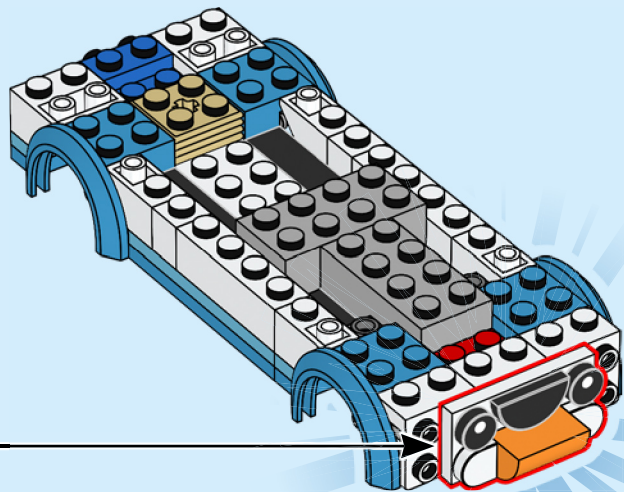
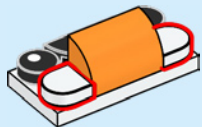

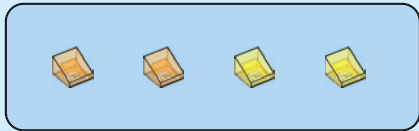

21

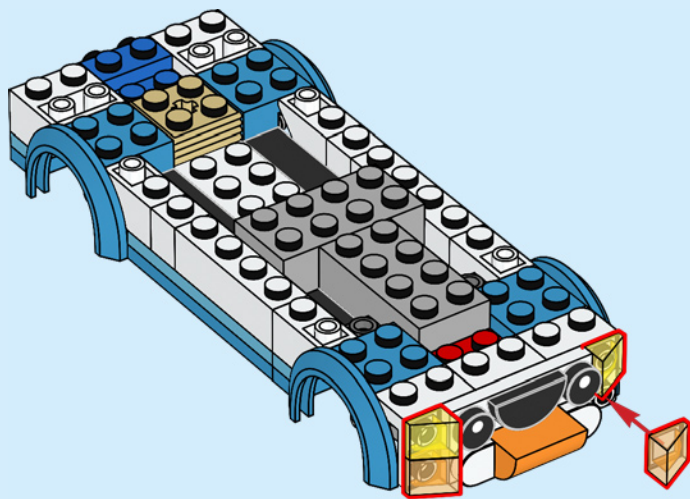

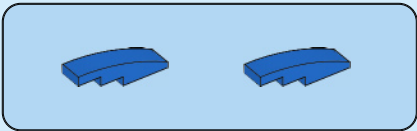

22

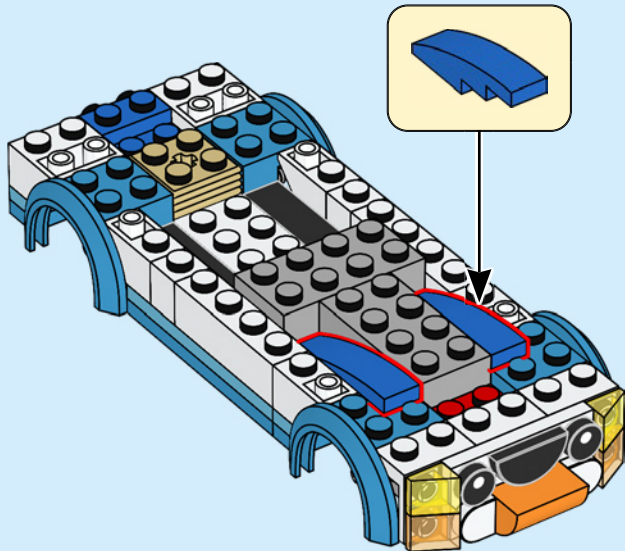



23

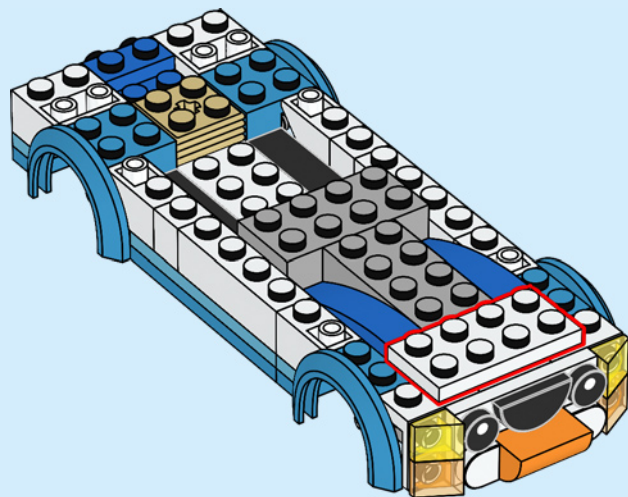

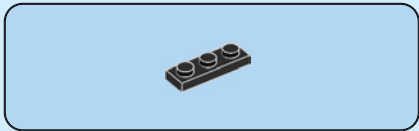

24

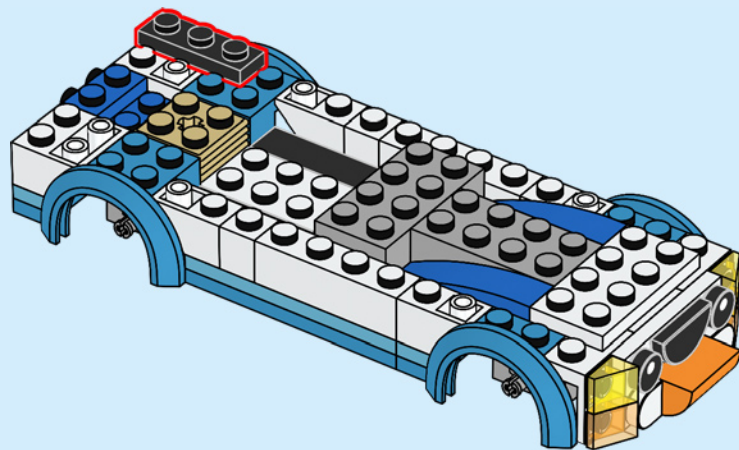

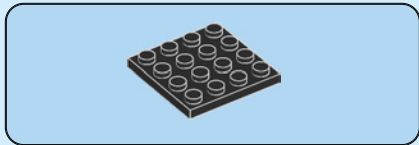

25

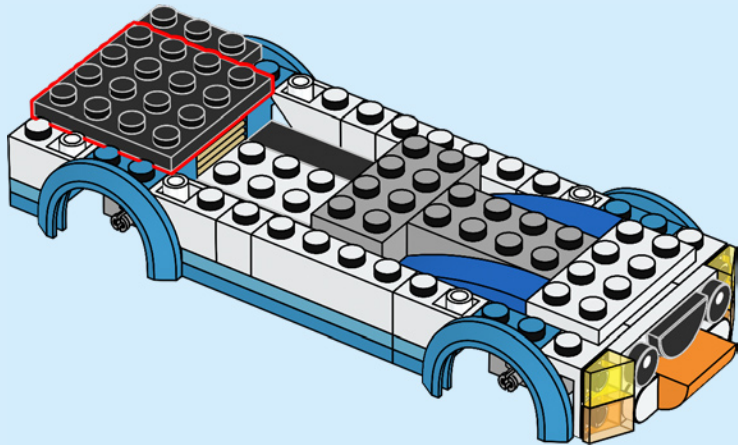

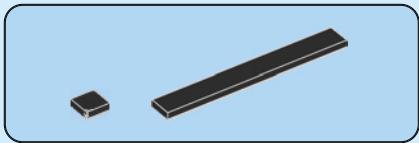

26

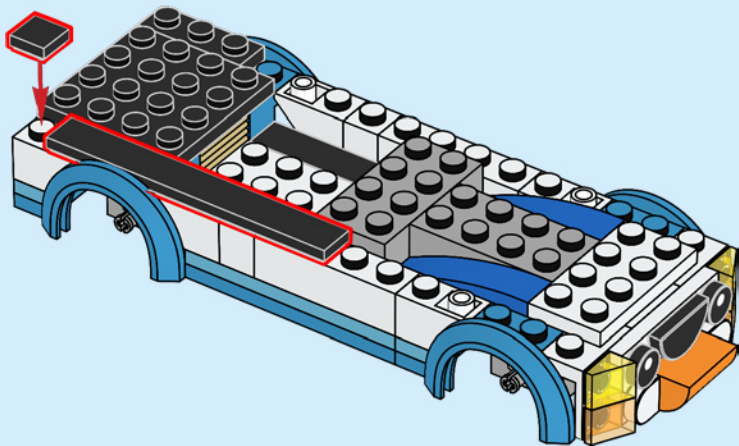

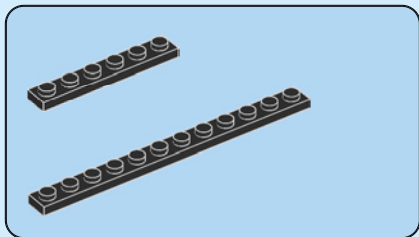

27

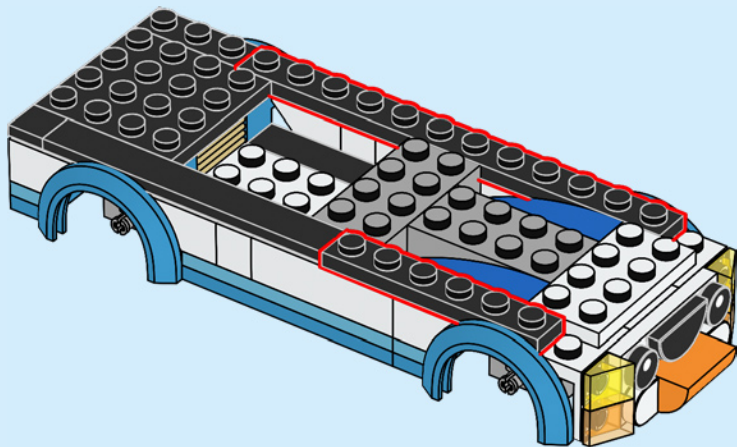

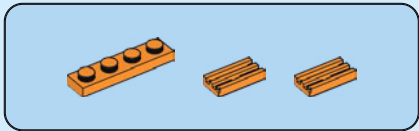

28

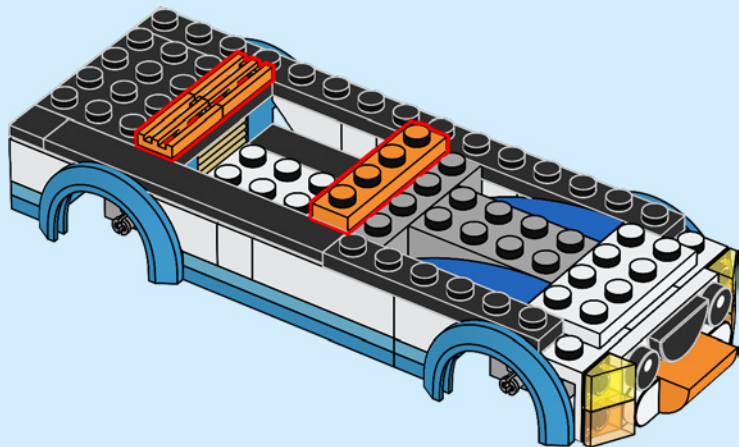

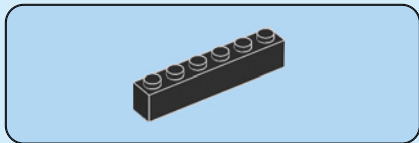

29

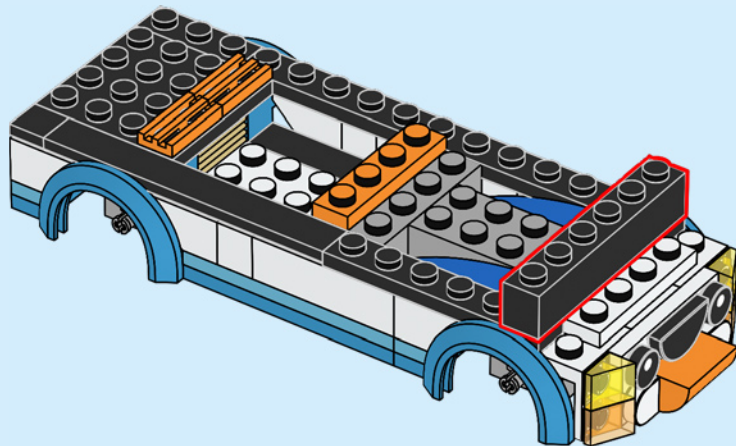

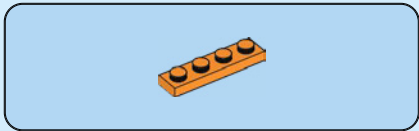

30

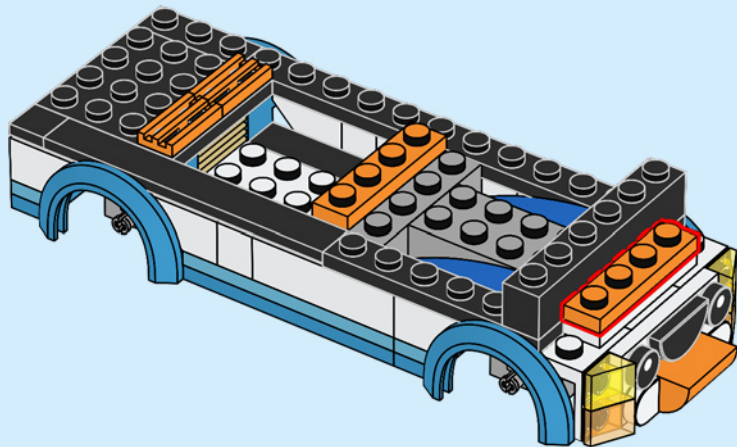



31

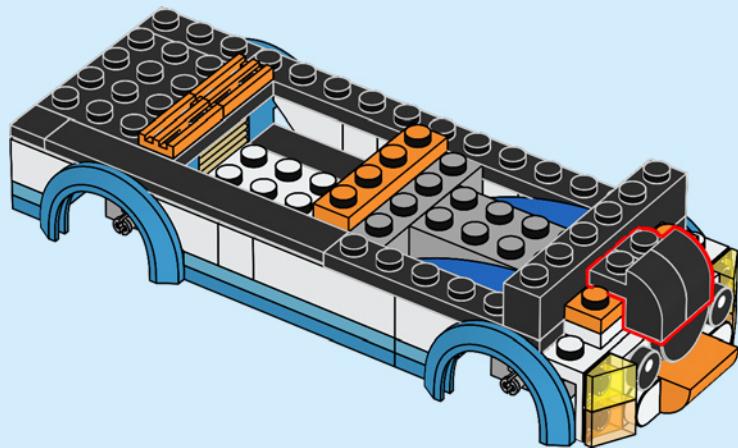



32

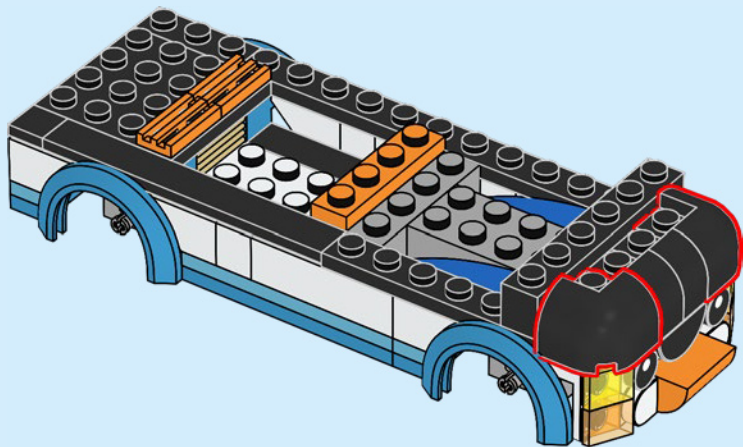

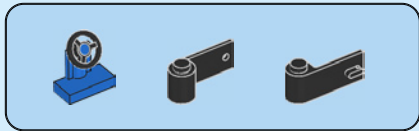

33

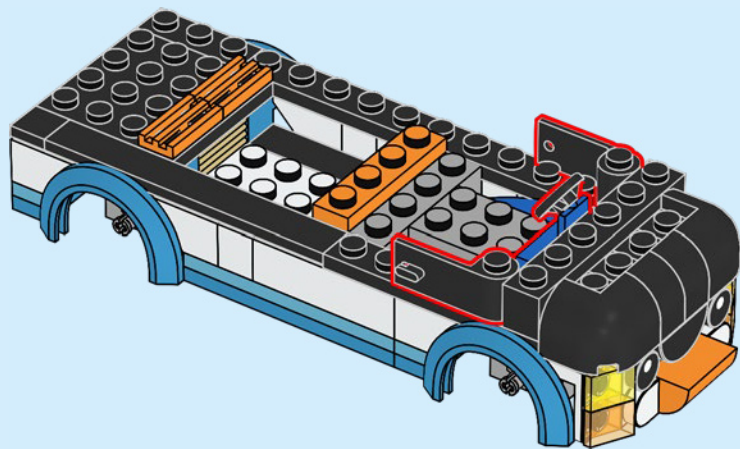

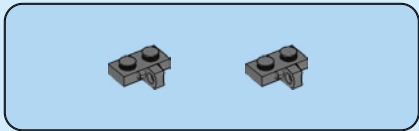

34

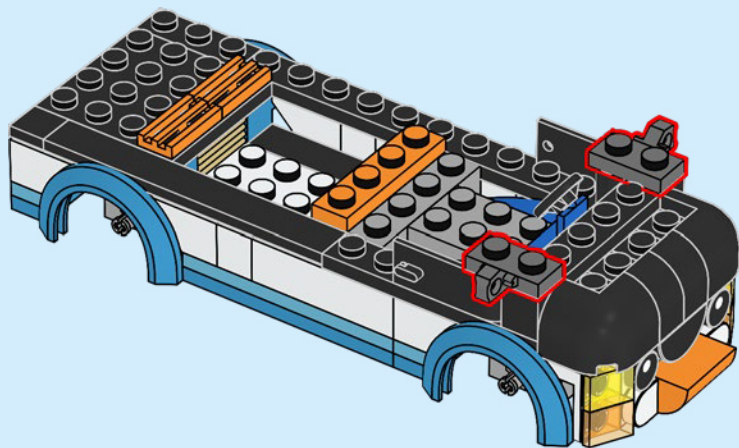

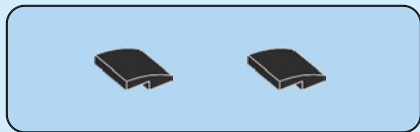

35

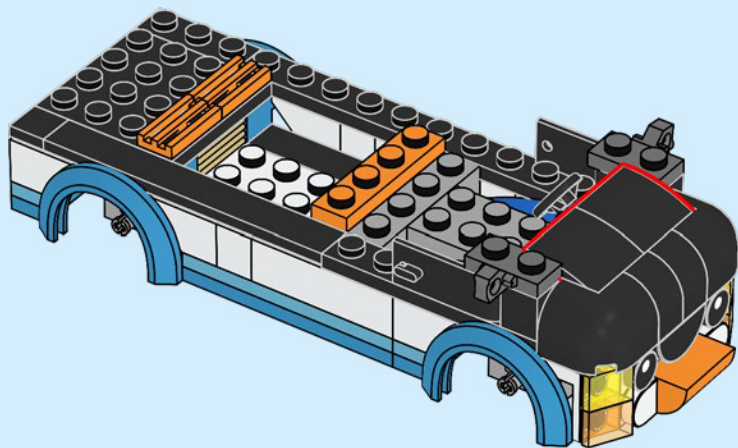

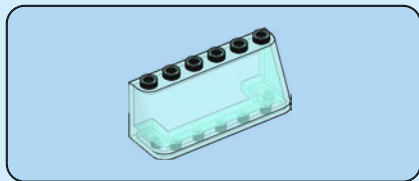

36

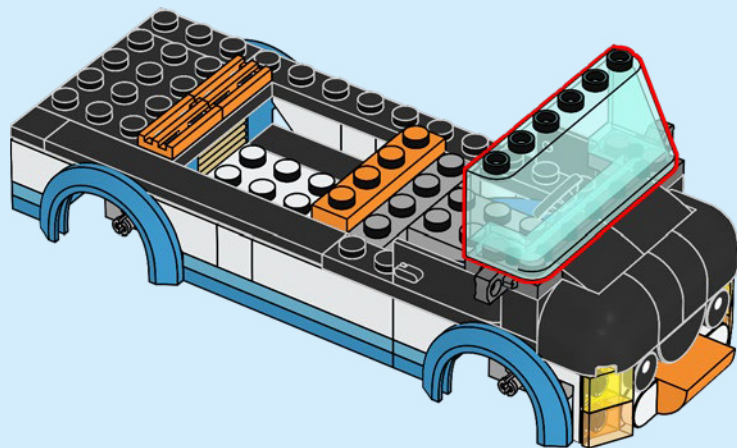





37

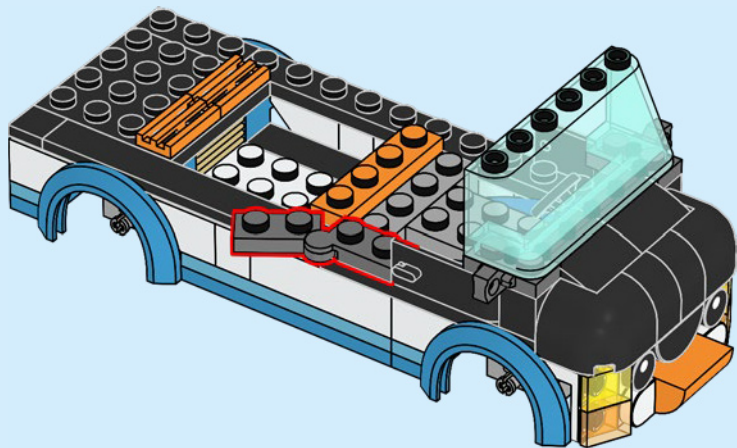

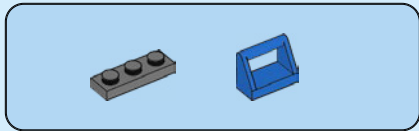

38

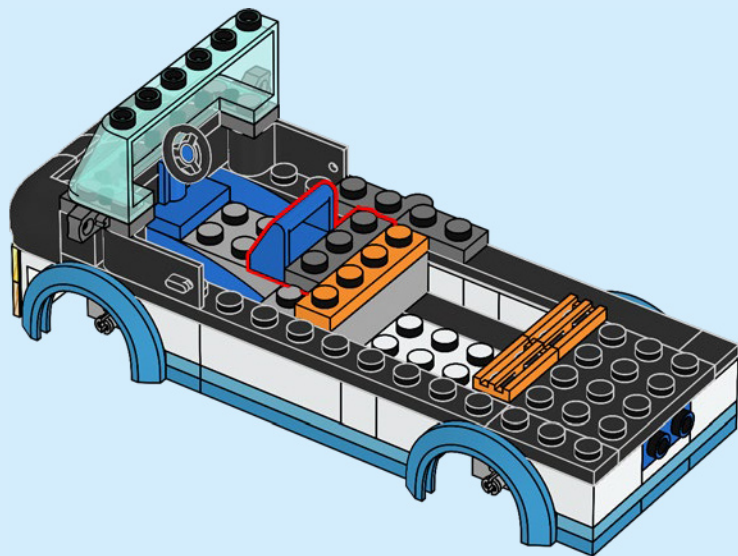
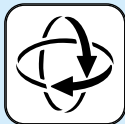

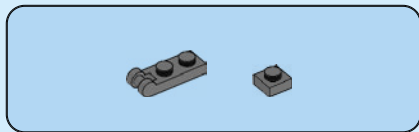

39

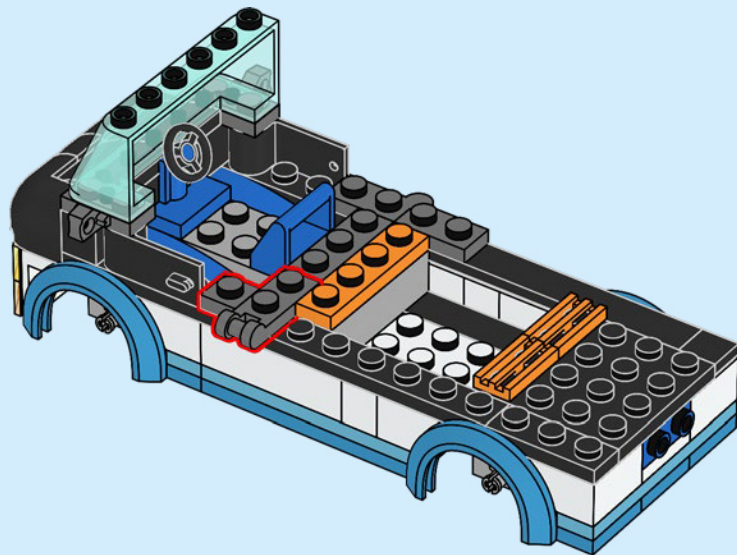

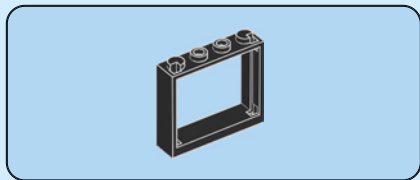

40

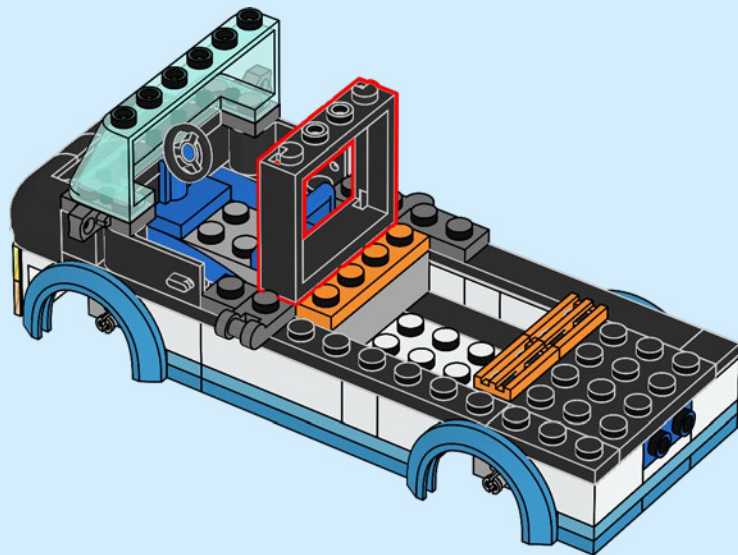

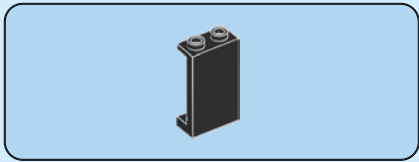

41

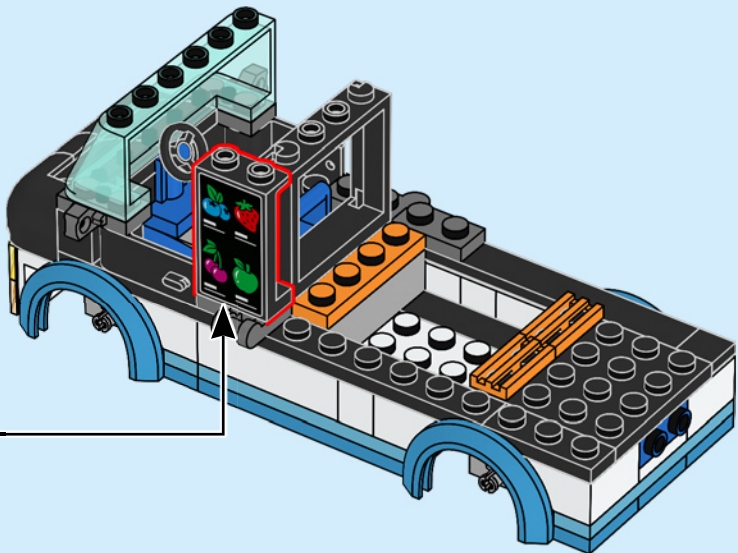
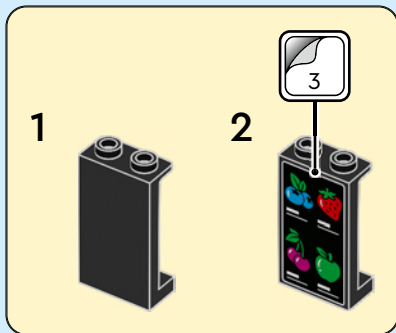

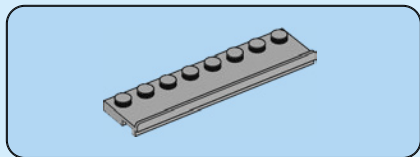

42

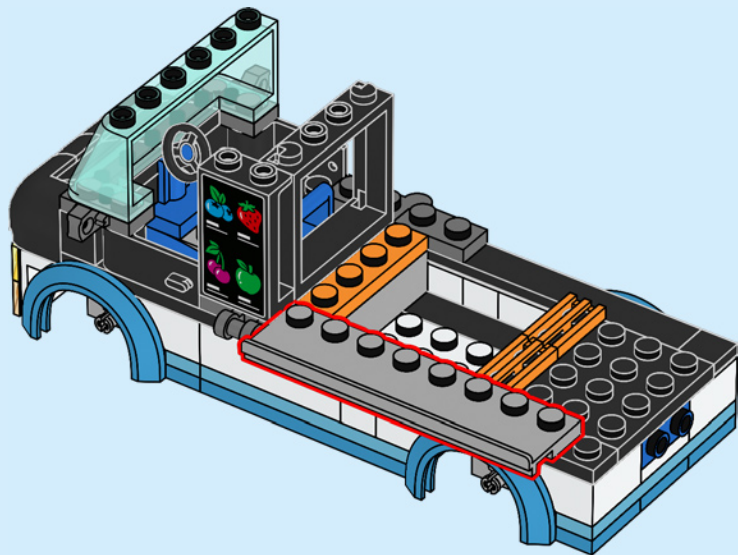

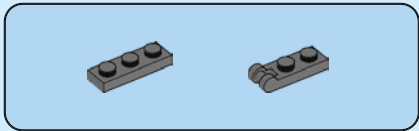

43

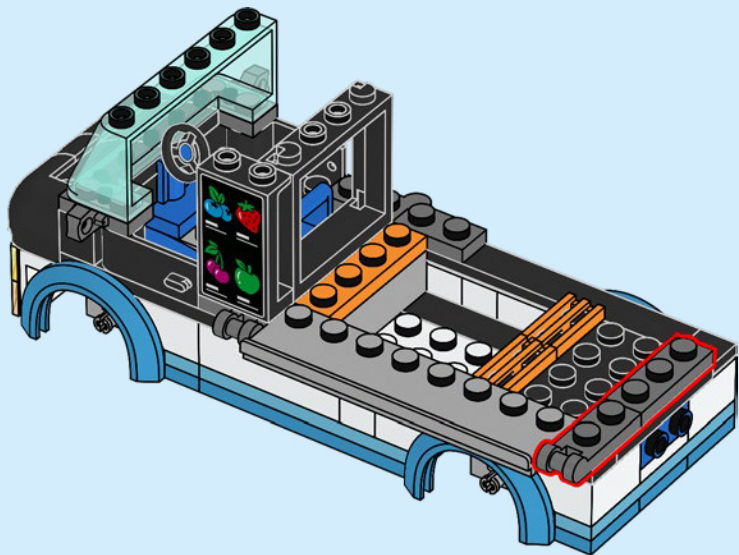

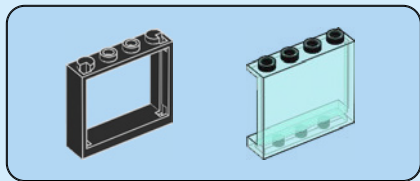

44

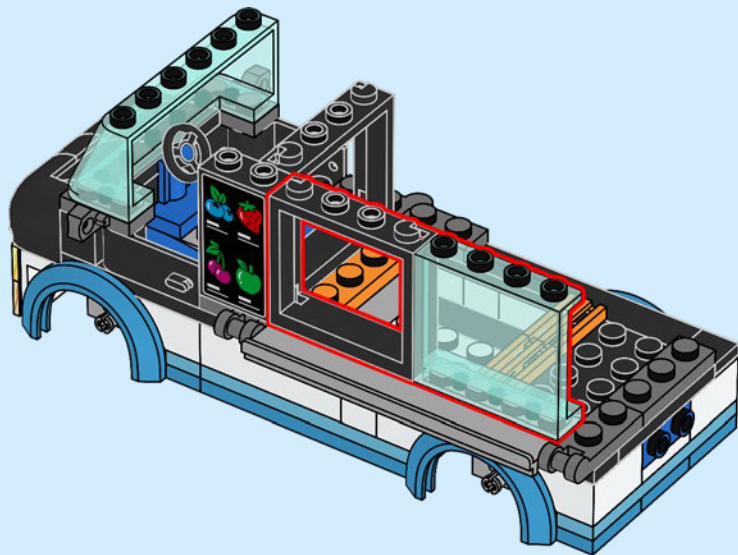

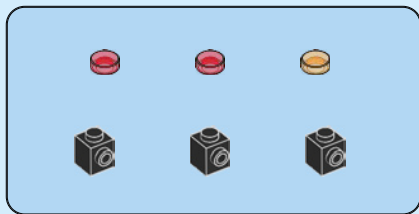

45

1



2

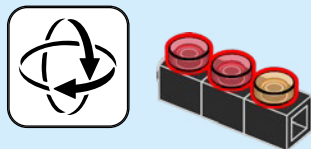

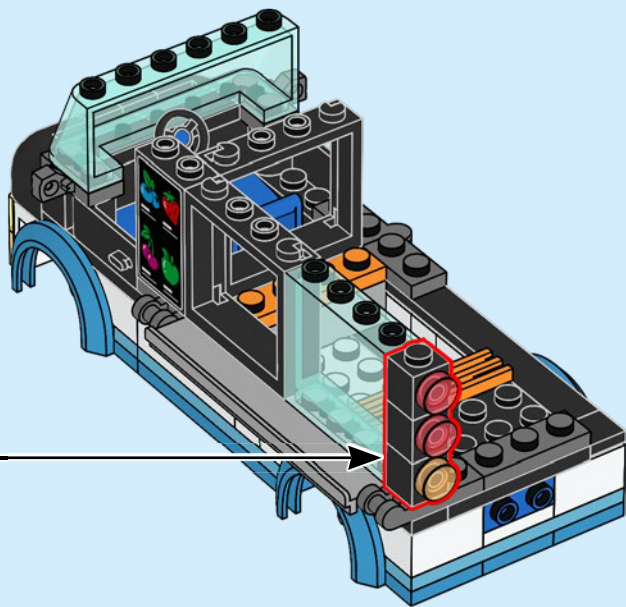

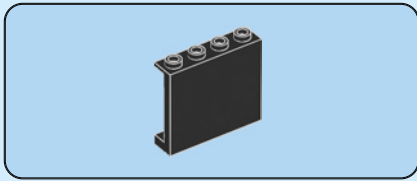

46

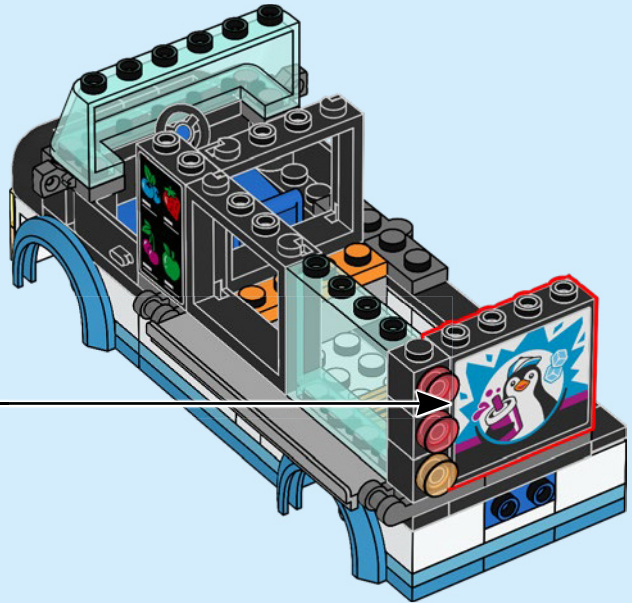
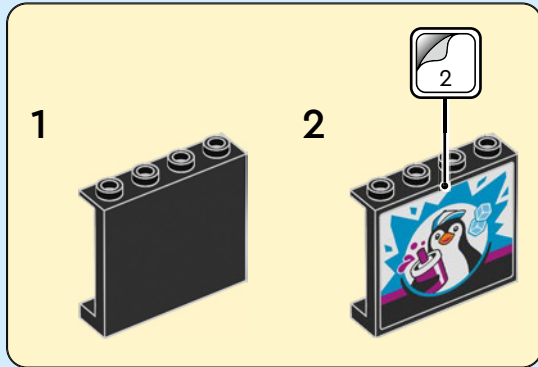

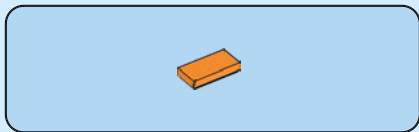

47

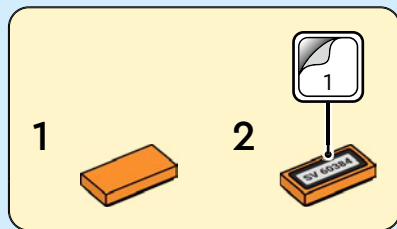
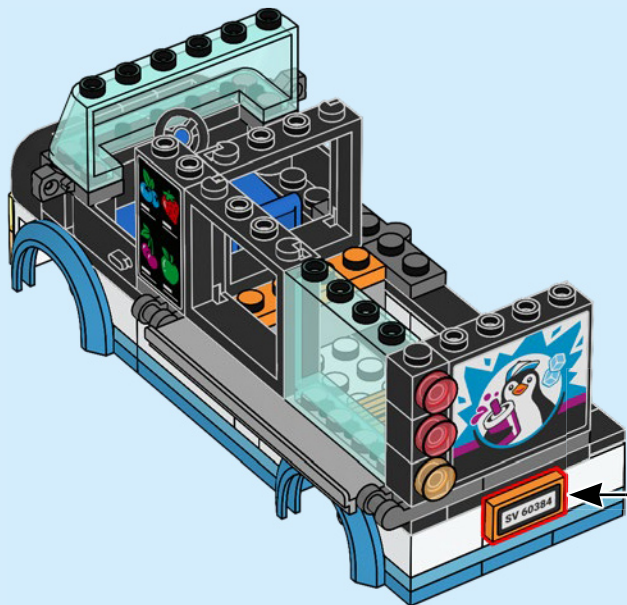

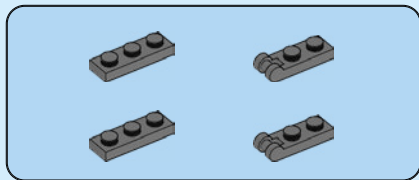

48

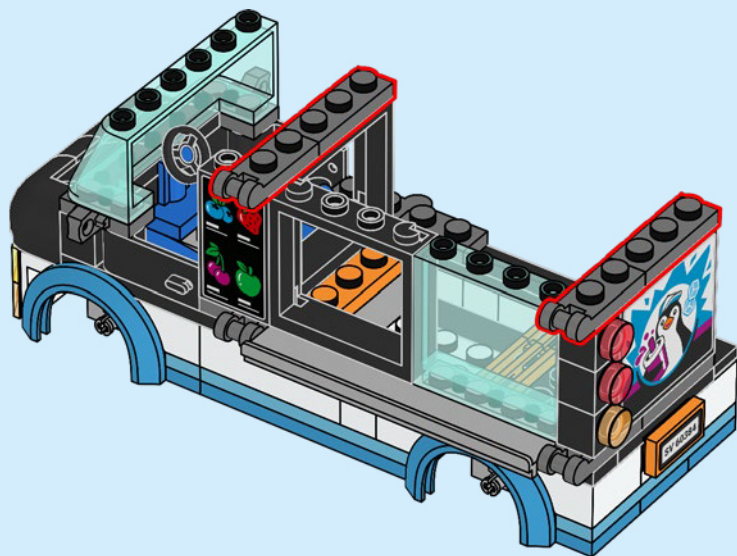

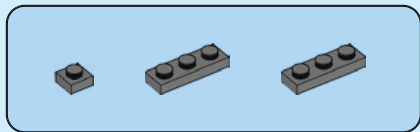

49

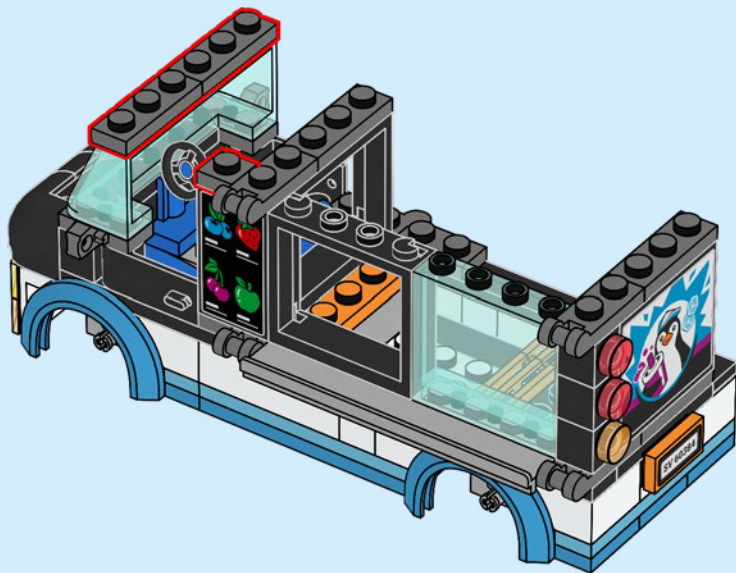

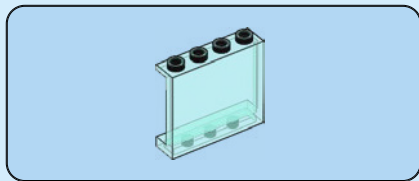

50

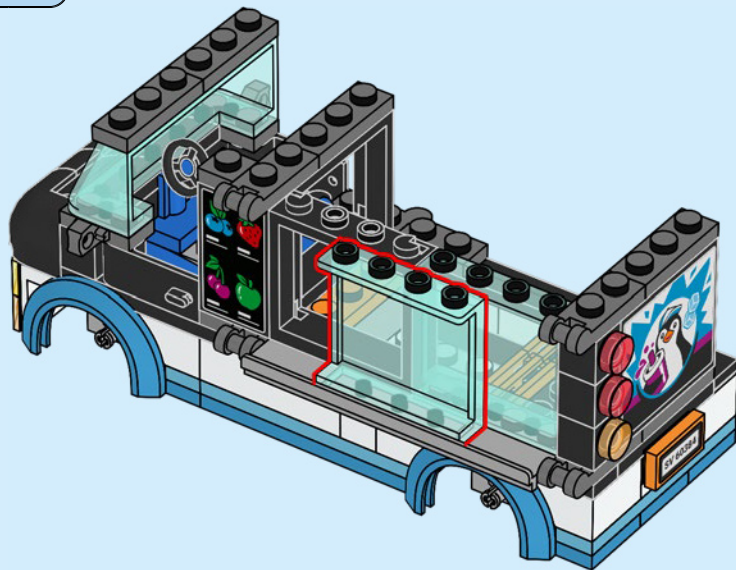

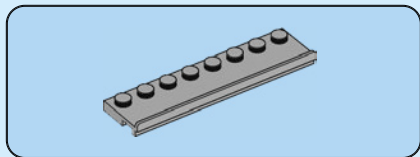

51

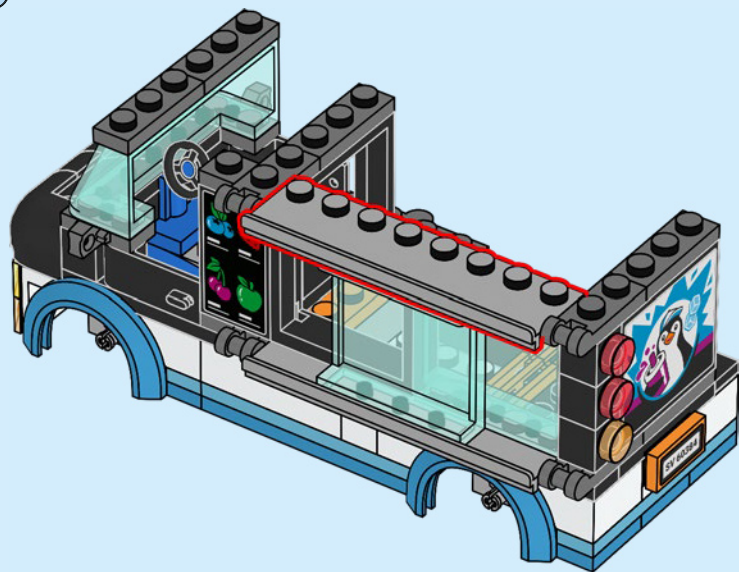

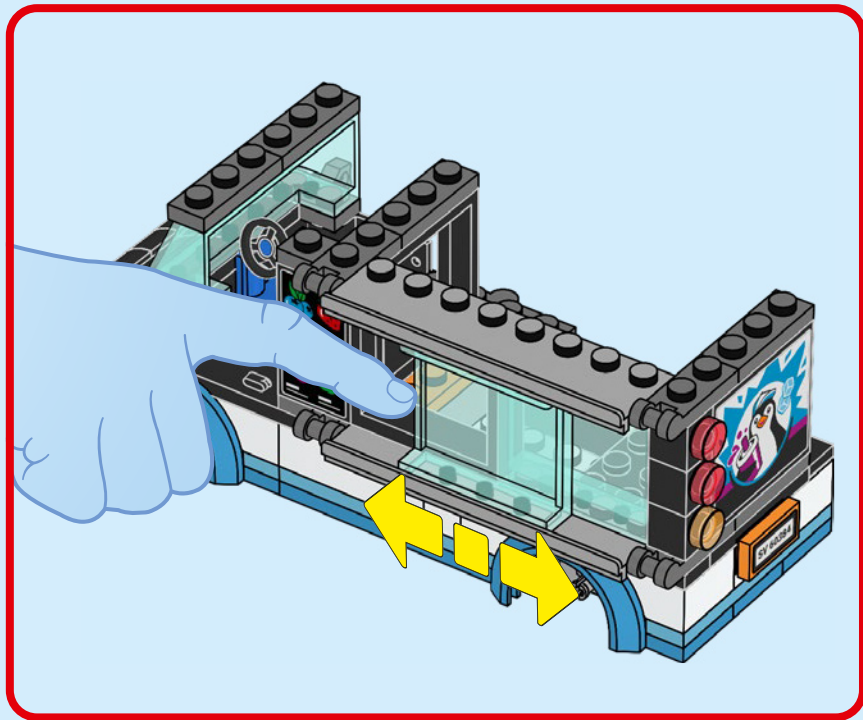



52

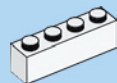
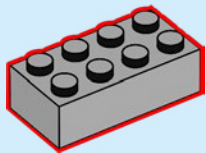

53

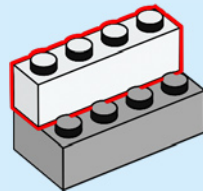

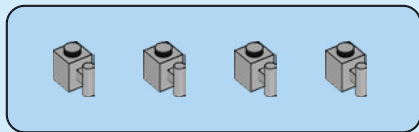

54

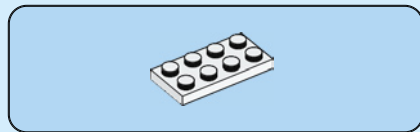
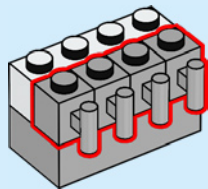

55

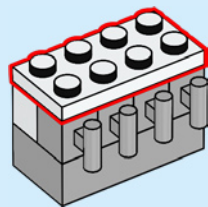

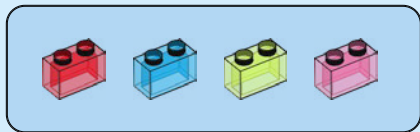

56

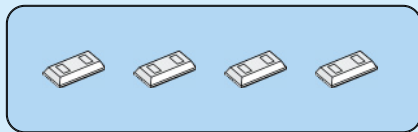
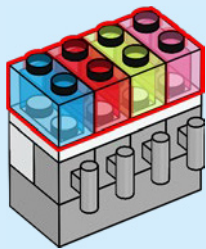

57

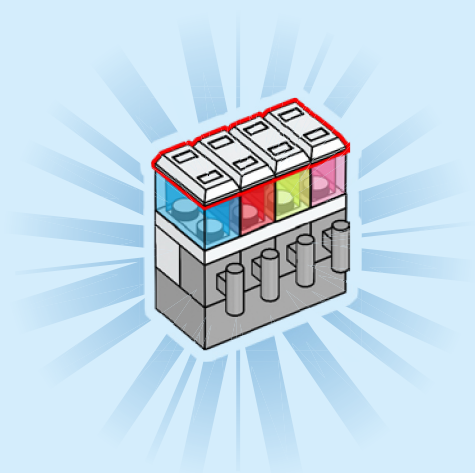

58

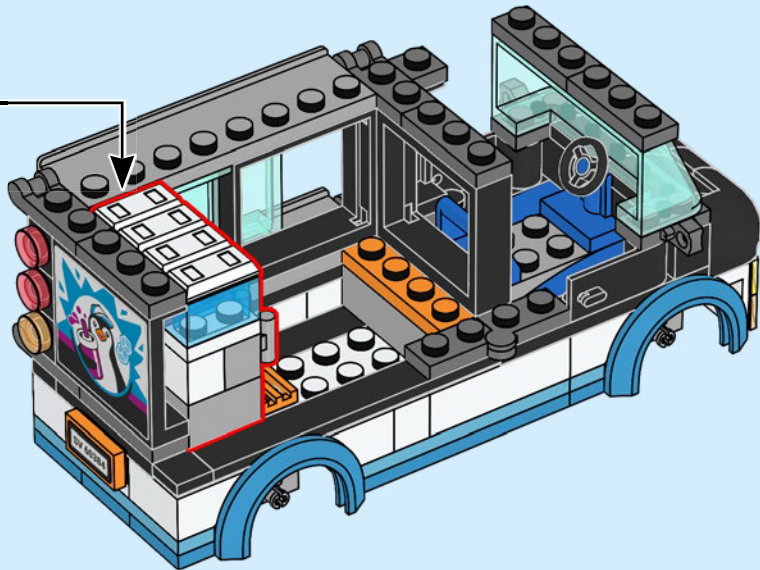
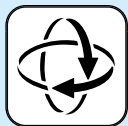

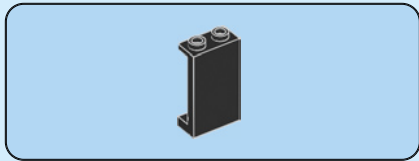

59

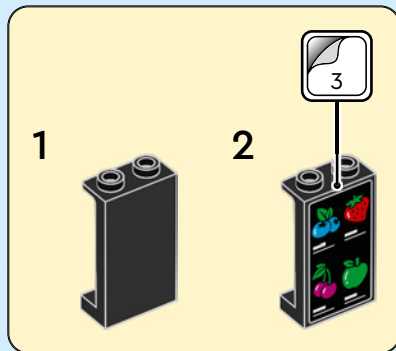
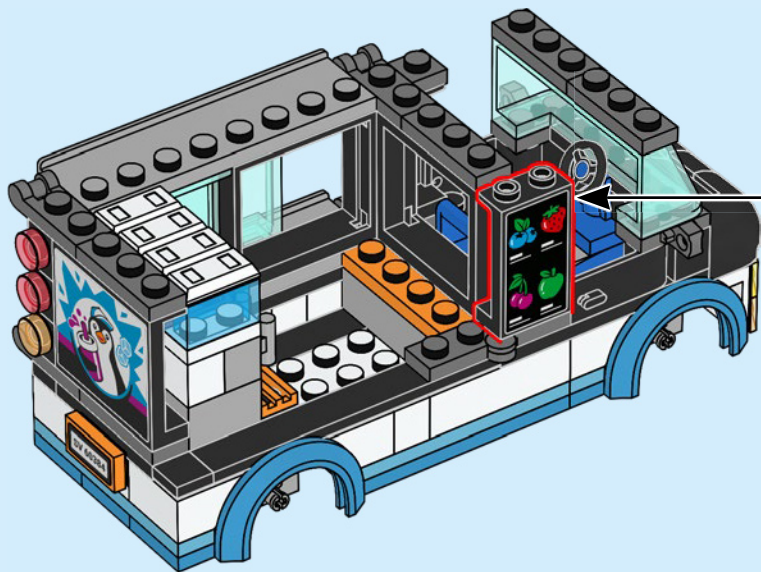

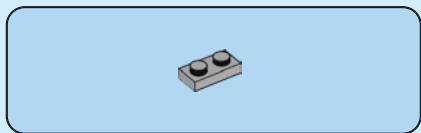
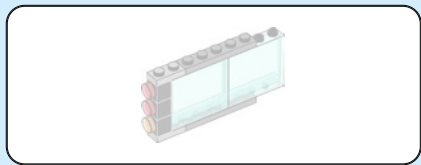

60

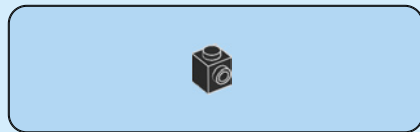
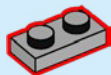

61



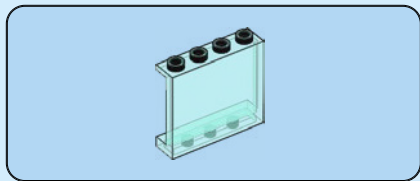

62

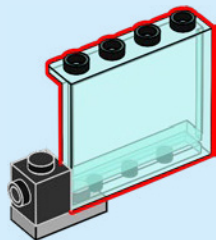

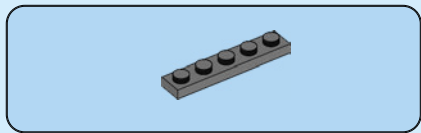

63

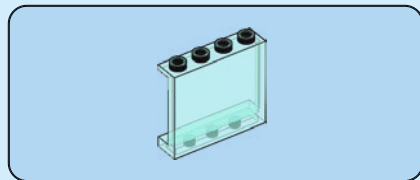
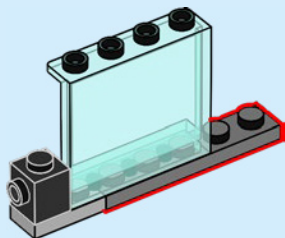

64

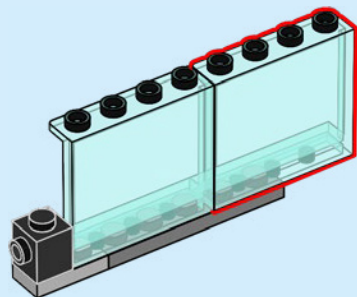



65

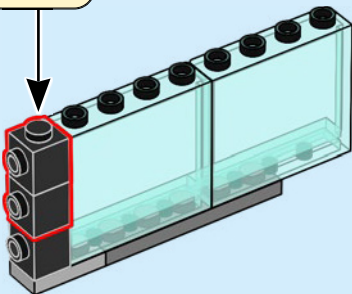
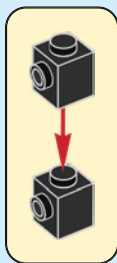

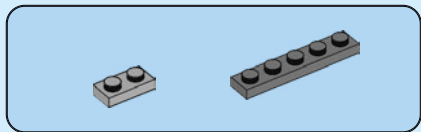

66

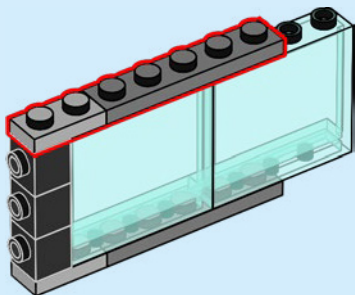

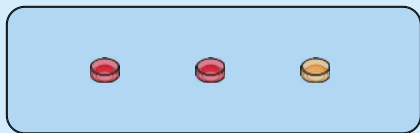

67

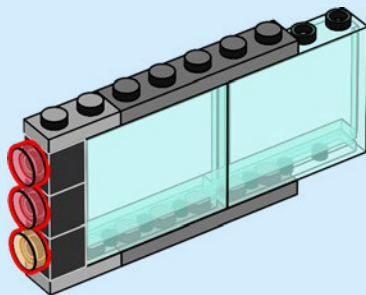

68

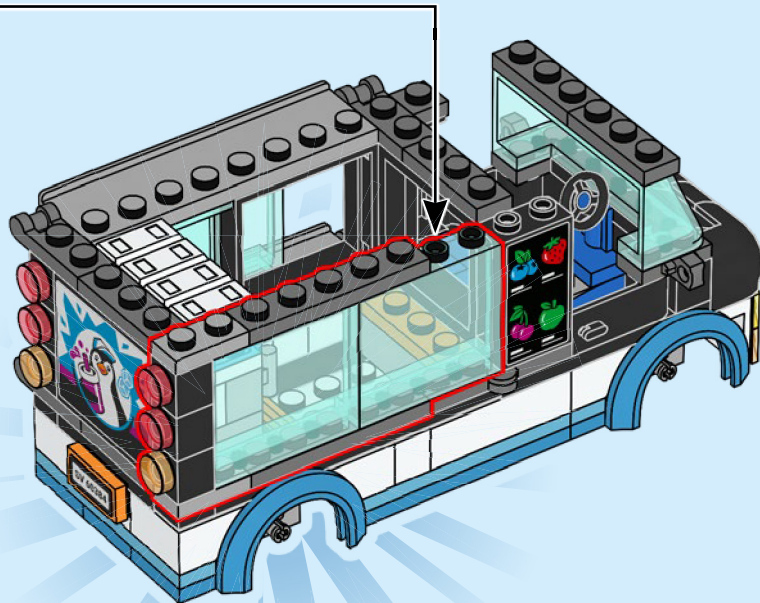

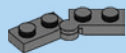

69

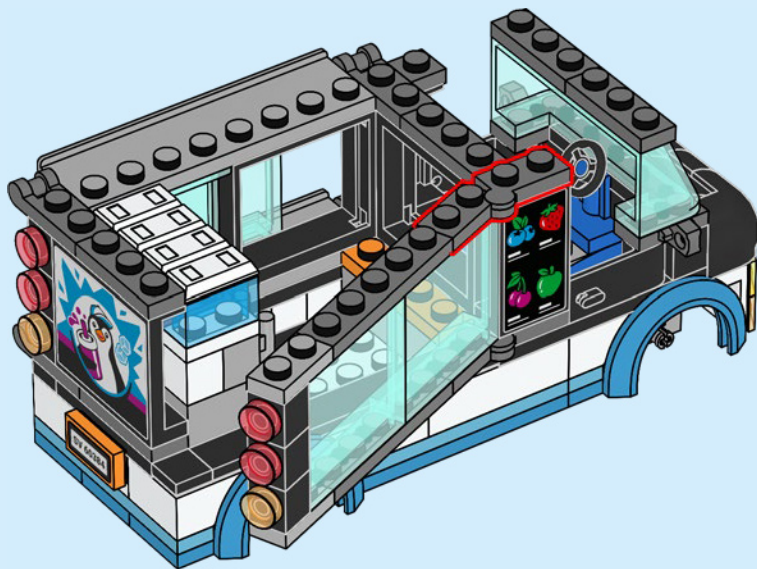

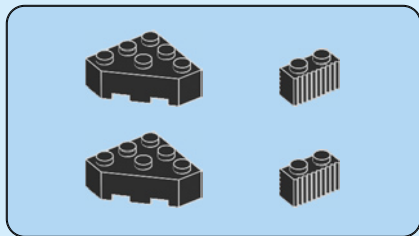

70

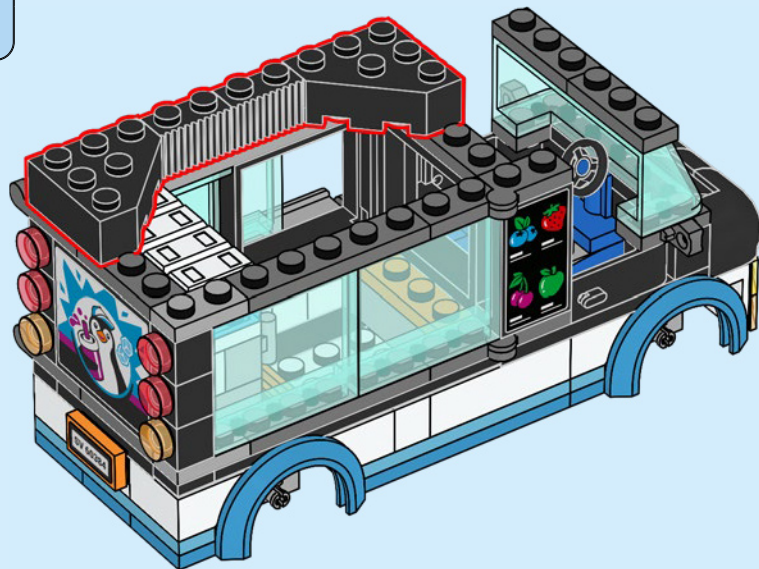

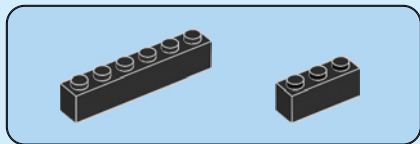

71

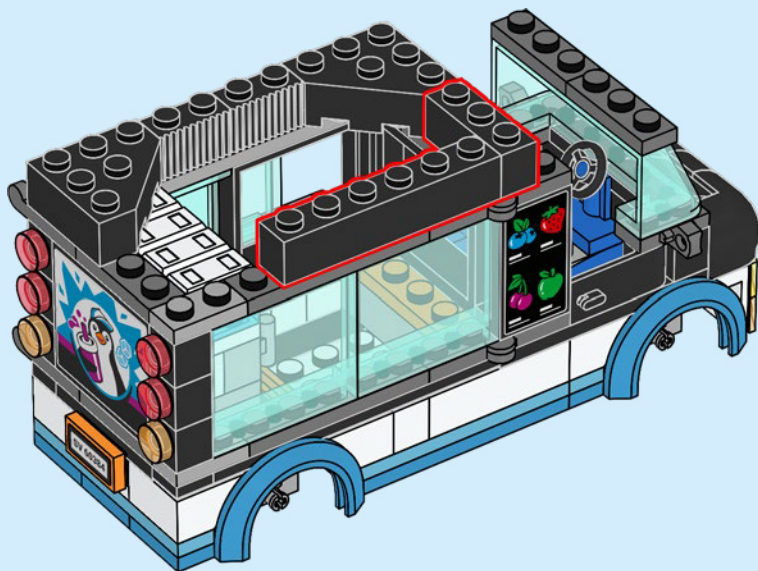



72

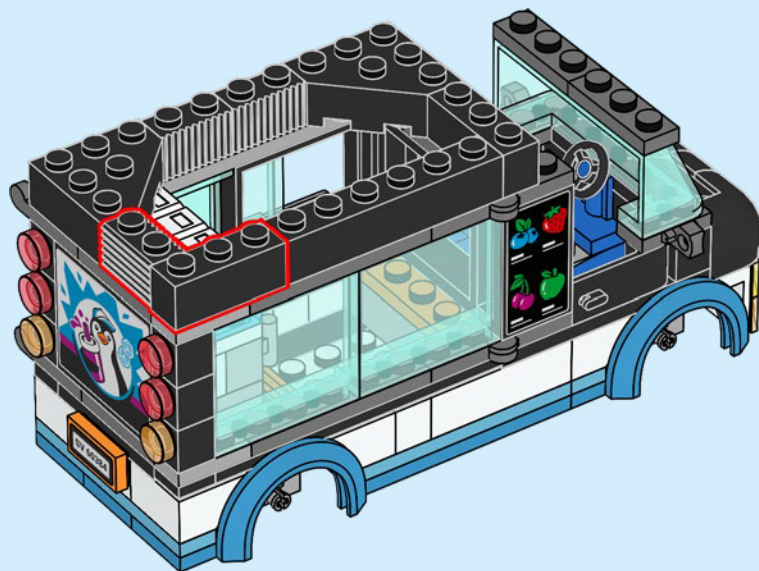

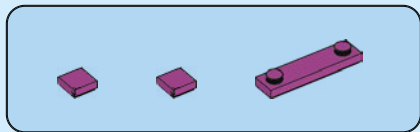

73

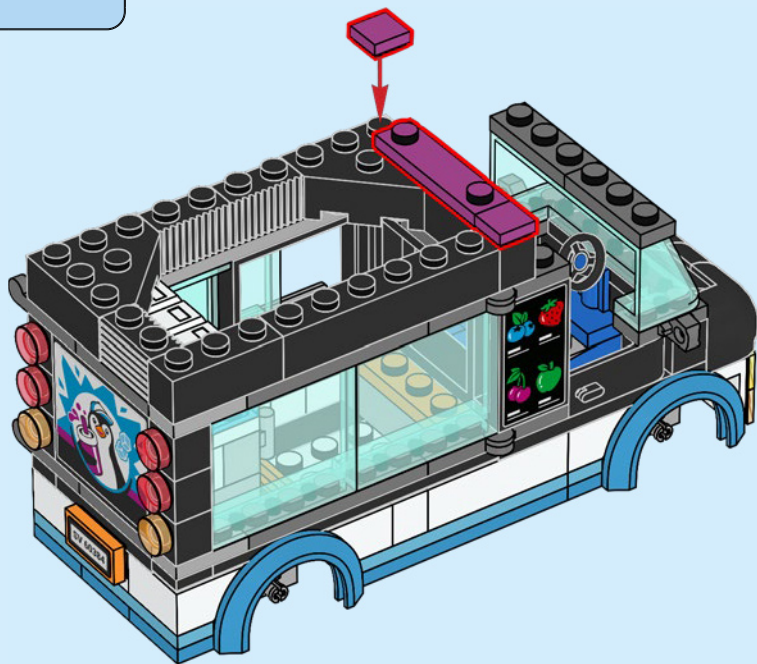

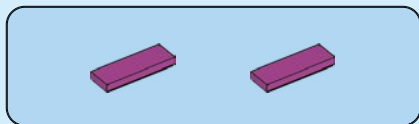

74

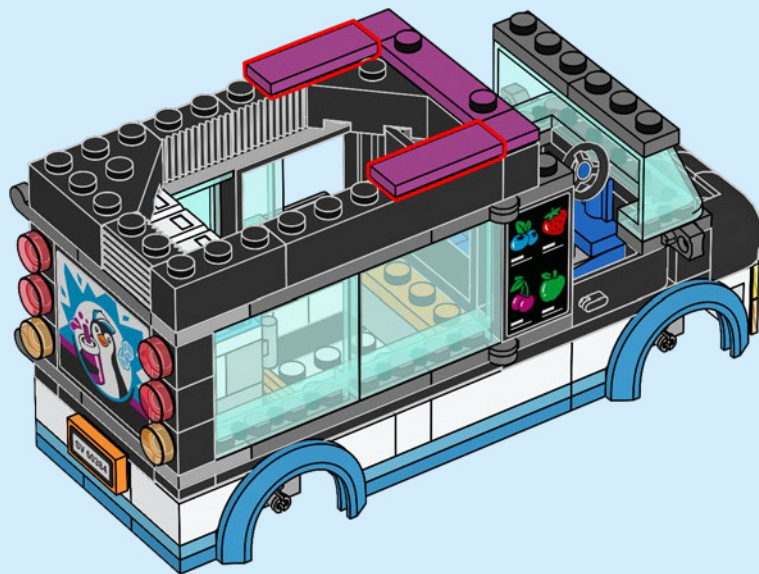

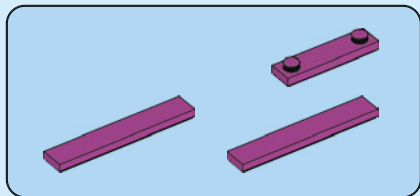

75

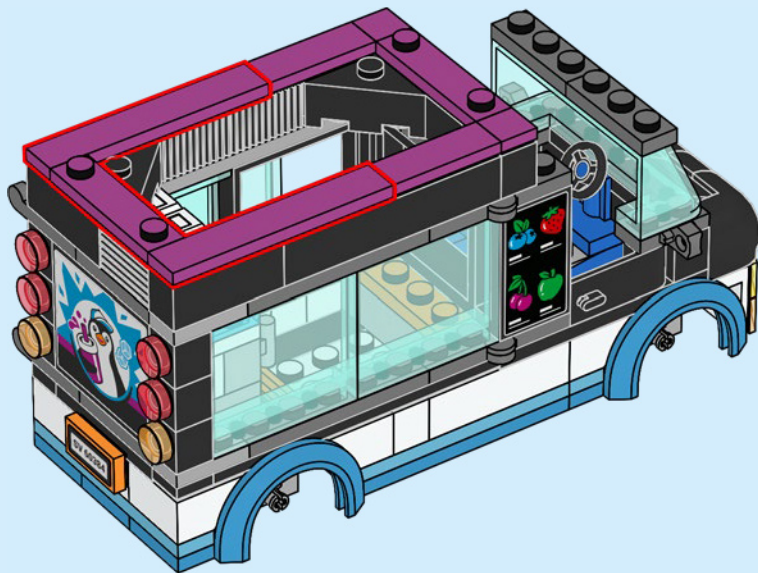

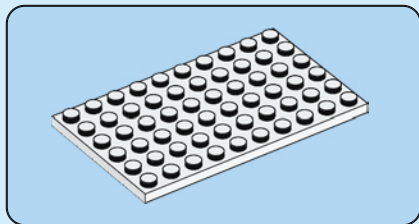

76

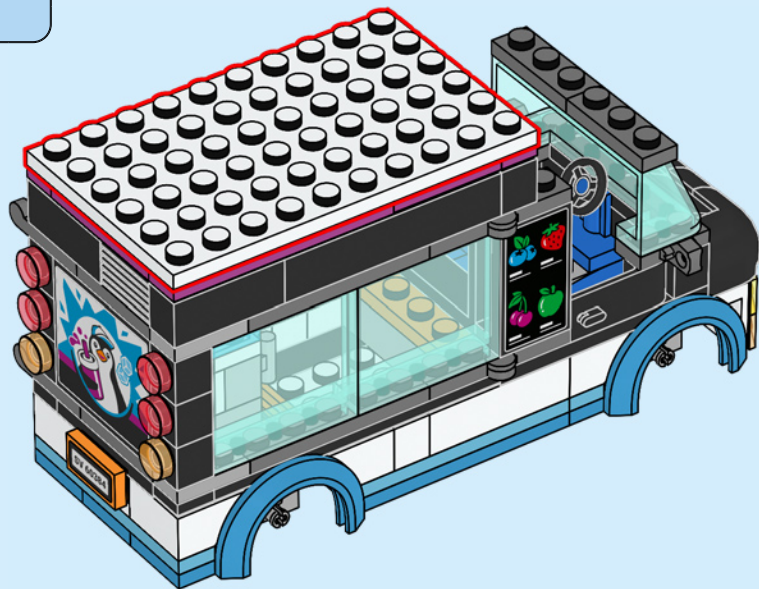

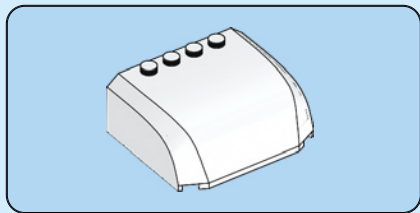

77

1

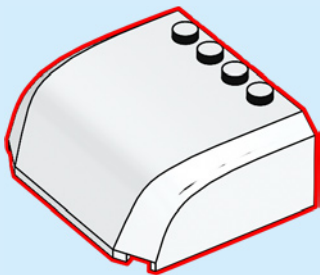

2

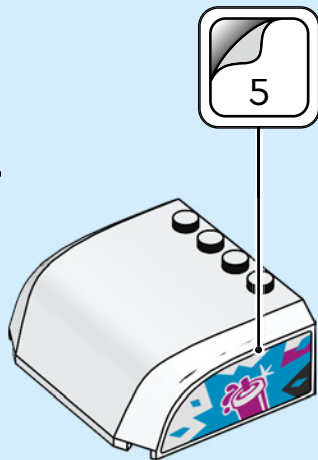



3

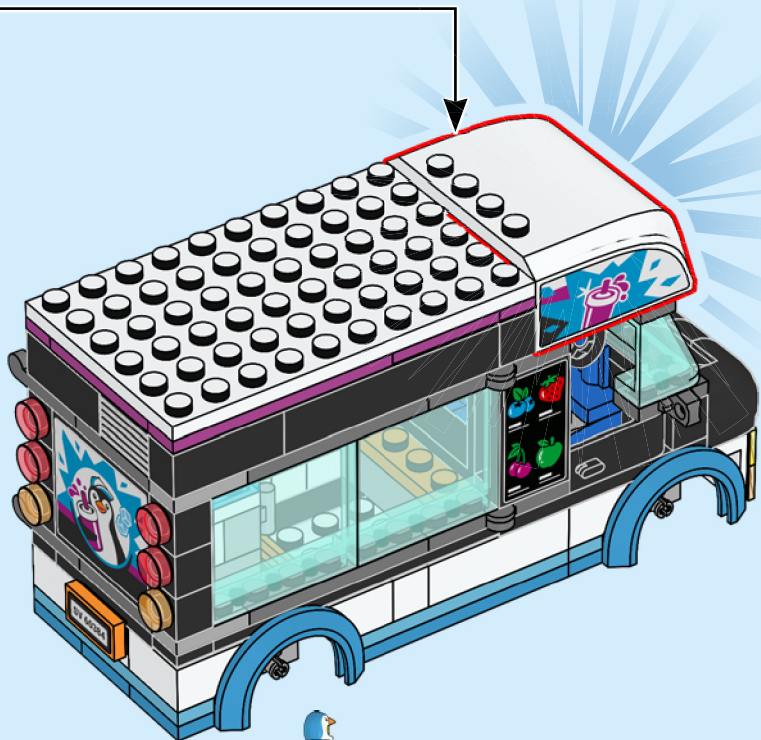
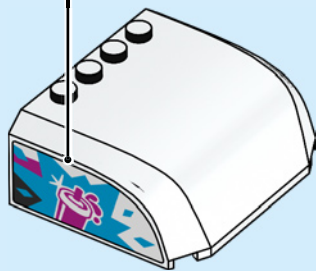

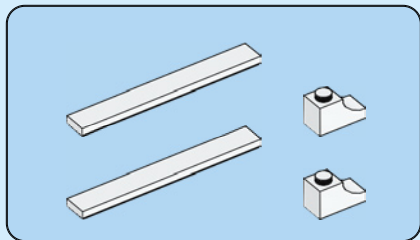

78

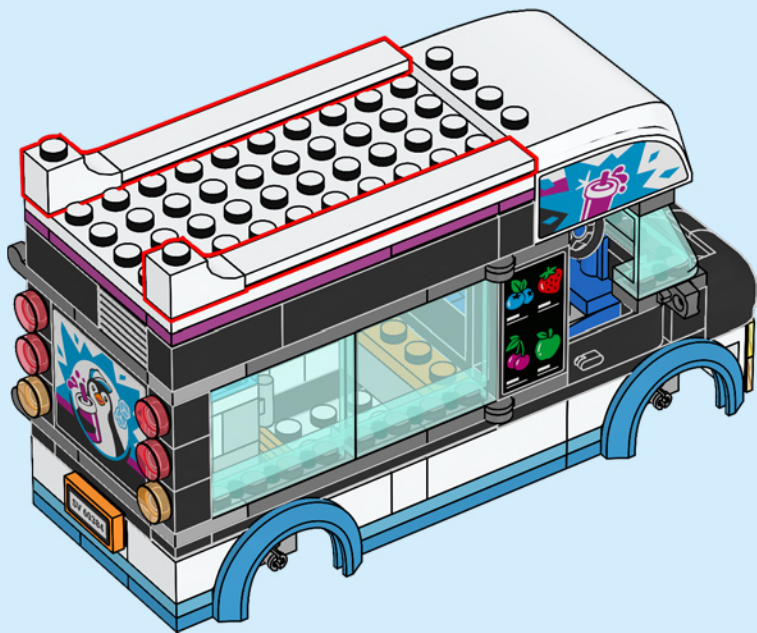

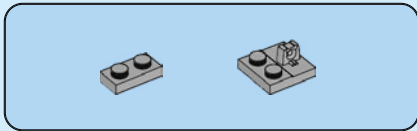

79

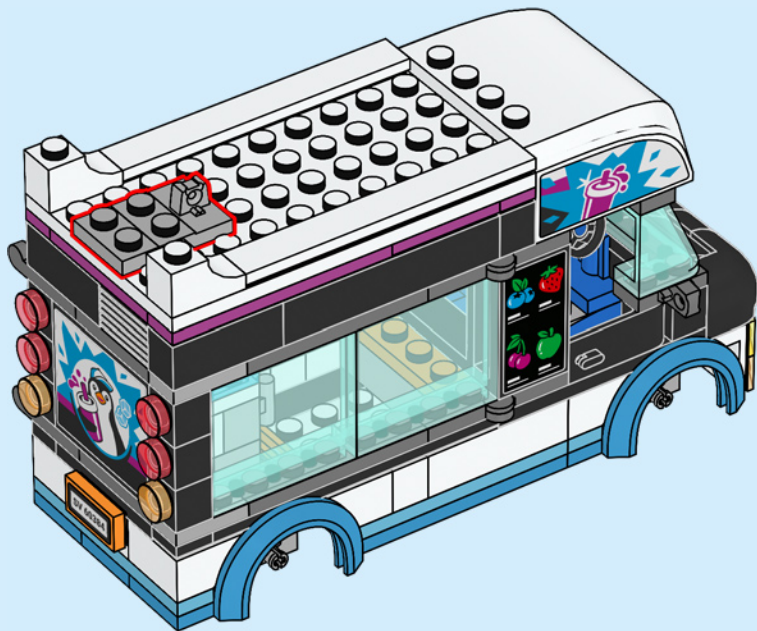



80

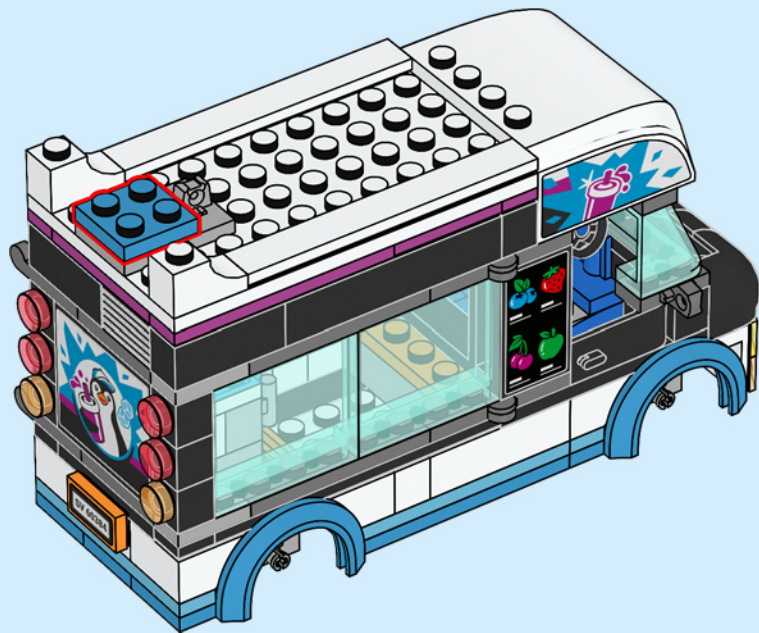

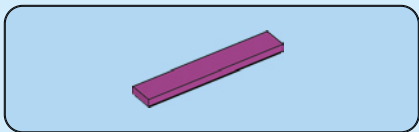

81

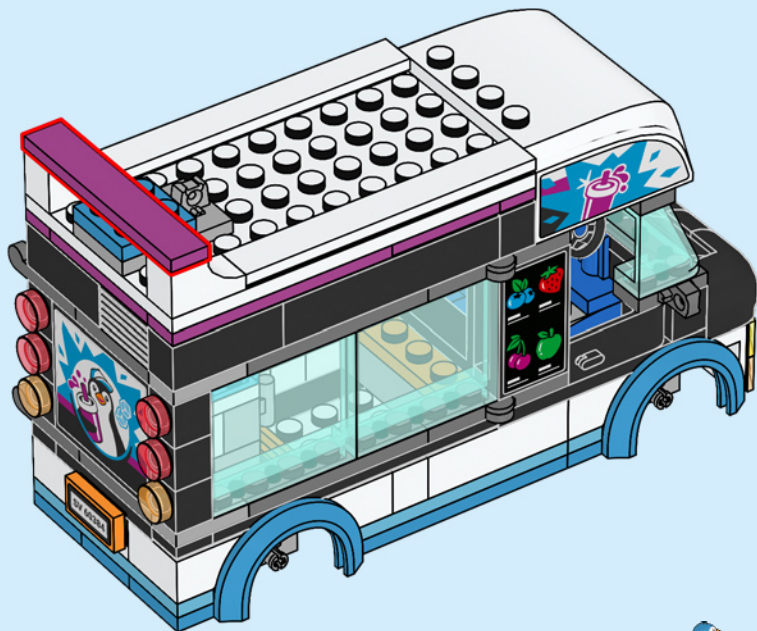



82





83



84



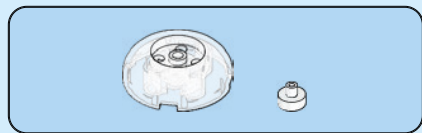

85





86



87

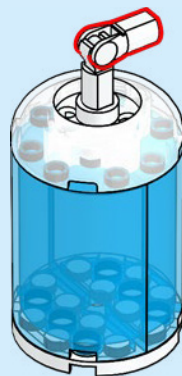

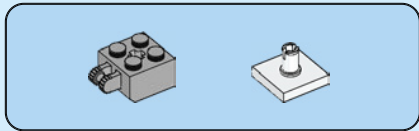

88

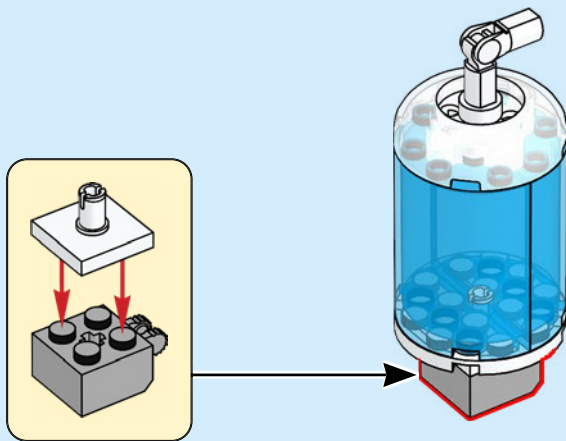

89

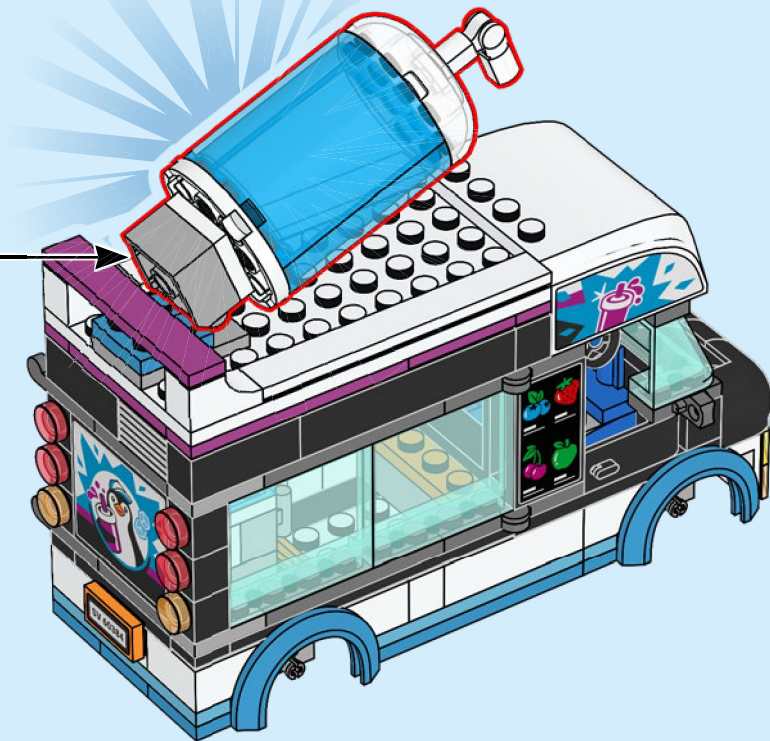

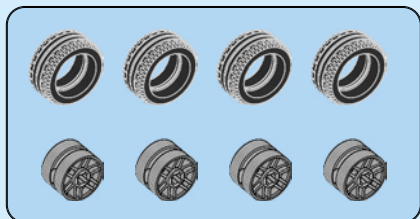

90

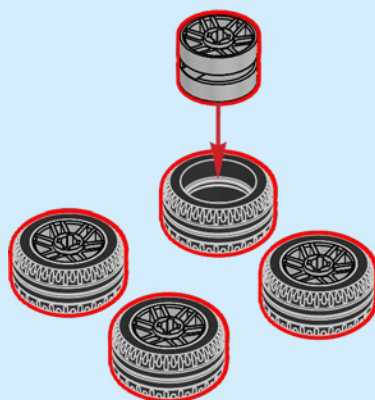

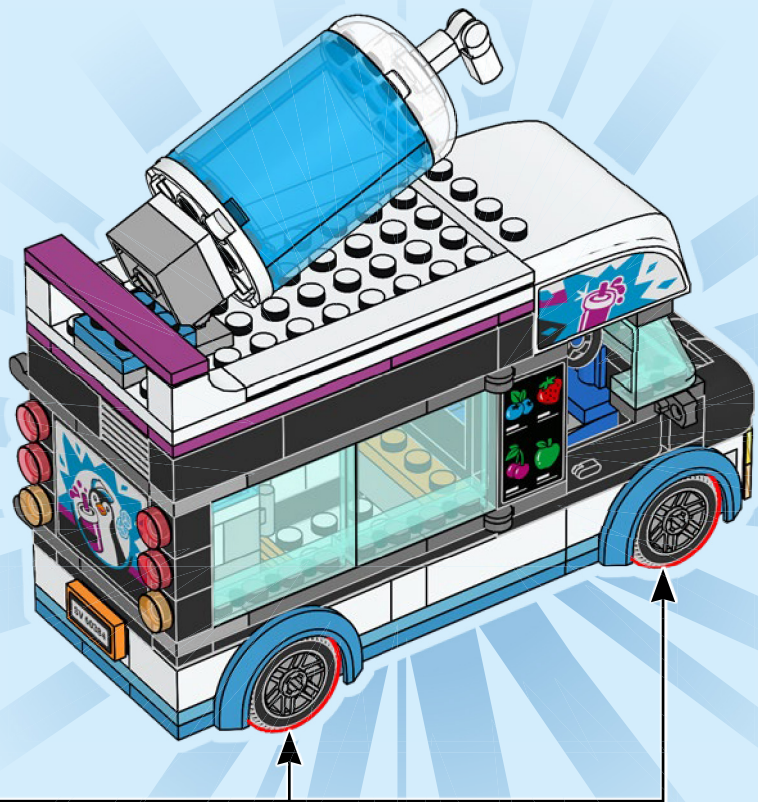

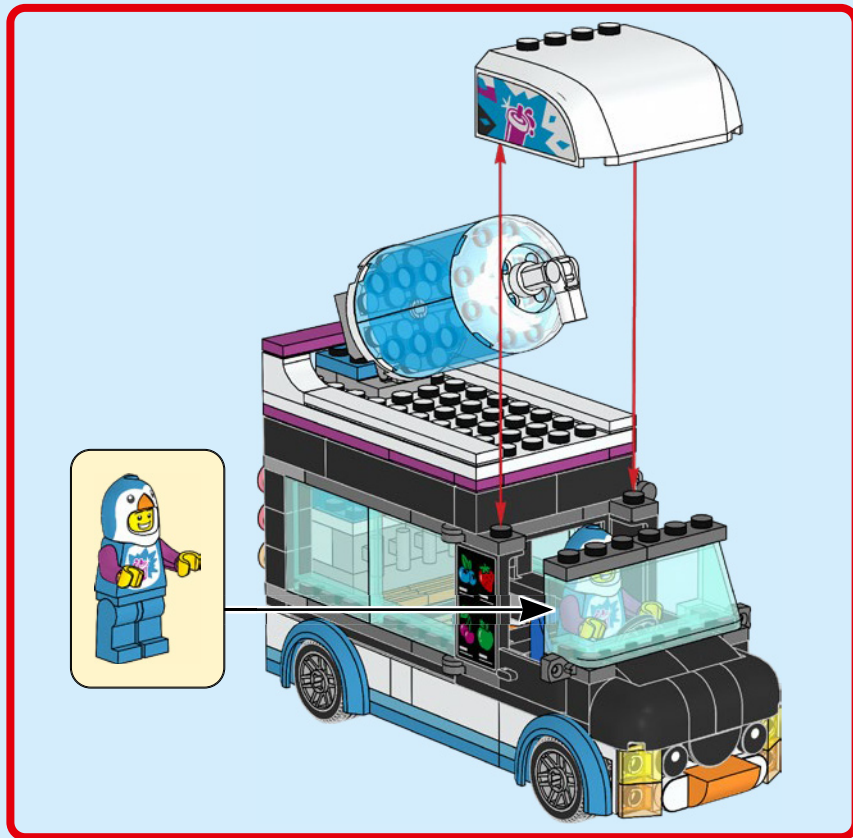





CITY



60387



60389



60383



60384



60385



CITY





1x
6341465



1x
6322489



1x
6186681



2x
6250591



2x
300501



4x
366501



2x
6346616



4x
6210076



3x
6117940



1x
6313138



2x
6366391



1x
6425508



3x
301001



1x
4515347



3x
302001

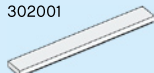

2x
416201

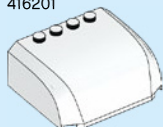

1x
6210111

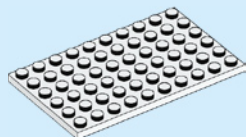

1x
4528341

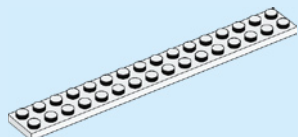

1x
4119227

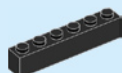

2x
300926

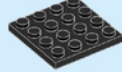

1x
4243819



3x
416226



1x
4514845



2x
4530589



2x
4159550



1x
366626



1x
6024113



4x
6029208



2x
6053077



2x
6359039



1x
6024114



2x
6284072



6x
4558954



3x
287726



2x
4614788



2x
6184784



1x
362326



2x
362226



1x
6420852



1x
4558209



1x
307026



1x
9566



1x
243223



1x
6116797



2x
6045938



1x
6330903



1x
302221



1x
6312495



1x
6153335

2x
6186867



1x
6360033



1x
6238673



4x
6258607



1x
6244905



4x
6245267

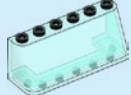

1x
6245193



1x
6238044



1x
6244906



2x
6422707



2x
6245272



1x
6385785



1x
4188771



4x
4125254



2x
4118782



1x
6322126



1x
6244913



1x
6244911

2x
6099364



2x
6211410



2x
6249090



3x
6102821



2x
6274747



2x
6245265



4x
6170569



3x
4211398



4x
6029209



1x
6265742



4x
6371448



1x
6263494



3x
4211385

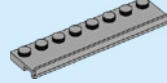

2x
4222019



2x
4210719



2x
6266248



4x
4521187



6x
4211133



2x
6416526



2x
6413109



2x
6185675



1x
6333518



4x
4653988



1x
6206809



1x
6425483



1x
6005307



1x
6419171



4x
6133729



2x
4640891



1x
6249123

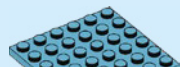

1x
6381912

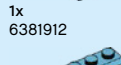

2x
4625036

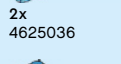

 [LEGO.com/service](https://www.lego.com/service)

YOU COULD **WIN**

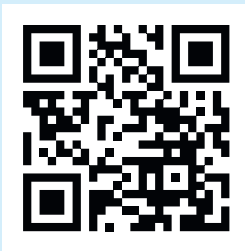

Scan this QR code or go to **LEGO.COM/PRODUCTFEEDBACK** and give us your short feedback about this LEGO® set for a chance to win a cool LEGO prize.

Terms and Conditions apply*

DE: Du könntest GEWINNEN. Es gelten die Teilnahmebedingungen* **FR: Tu pourrais GAGNER.** Des conditions s'appliquent* **IT: Potresti VINCERE tu.** Termini e condizioni sono applicabili* **ES: Puedes GANAR.** Aplican términos y condiciones* **PT: Poderá GANHAR.** Aplicam-se termos e condições* **JA: プレゼント付き! 利用規約が適用されます*** **ZH: 轻松获奖. 条款和条件适用*** **KO: 상품의 주인이 되어보세요. 소정의 약관이 적용됩니다*** **RU: Вы можете ВЫИГРАТЬ.** Действуют положения и условия* **PL: Szansa na WYGRANĄ.** Obowiązują warunki korzystania* **CS: Máte šanci VYHRÁT.** Platí všeobecné smluvní podmínky* **SK: Máte šancu VYHRAŤ.** Platia všeobecné zmluvné podmienky* **HU: TE IS NYERHETSZ.** Felhasználási feltételek érvényesek* **RO: Ai putea CÂȘTIGA.** Se aplică termenii și condițiile* **BG: Можете да СПЕЧЕЛИТЕ.** Има определени правила и условия* **LV: Tu vari LAIMĒT.** Ir spēkā noteikumi un nosacījumi.* **ET: Sul on võimalus VÕITA.** Kehtivad tingimused* **LT: Jūs galite LAIMĖTI.** Taikomos sąlygos*

*LEGO.com/productfeedback-terms