

PHILIPS

Television

Quick Start Guide

9507 series

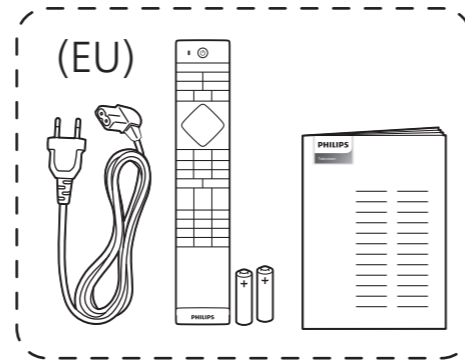
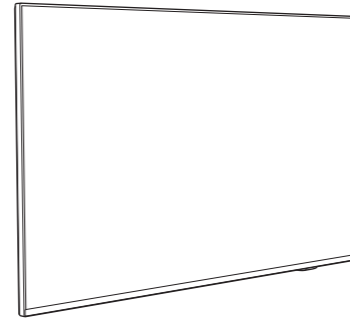

(UK)



55"/65"

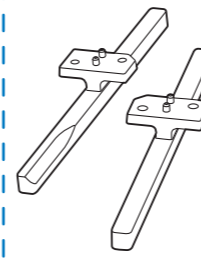

75"

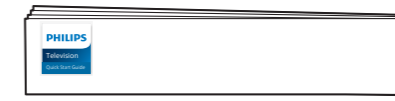
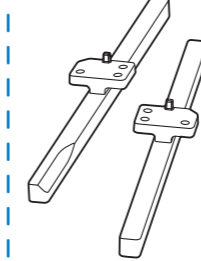

- 55"/65": x4
- 75": x6

A

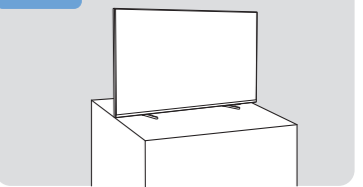

B

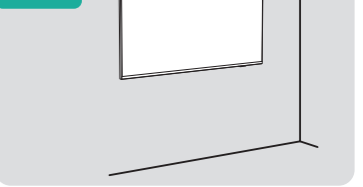

A

1a

55"

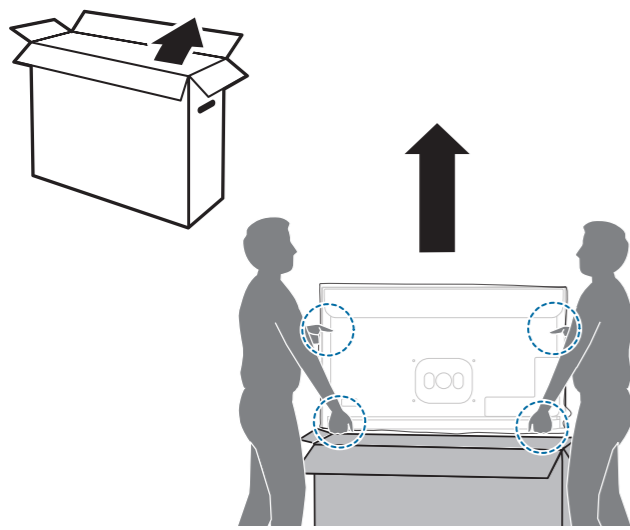

1b

65"/75"

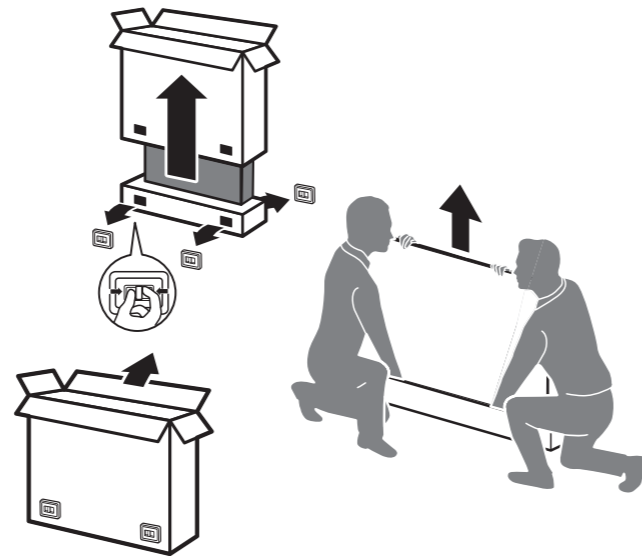

2

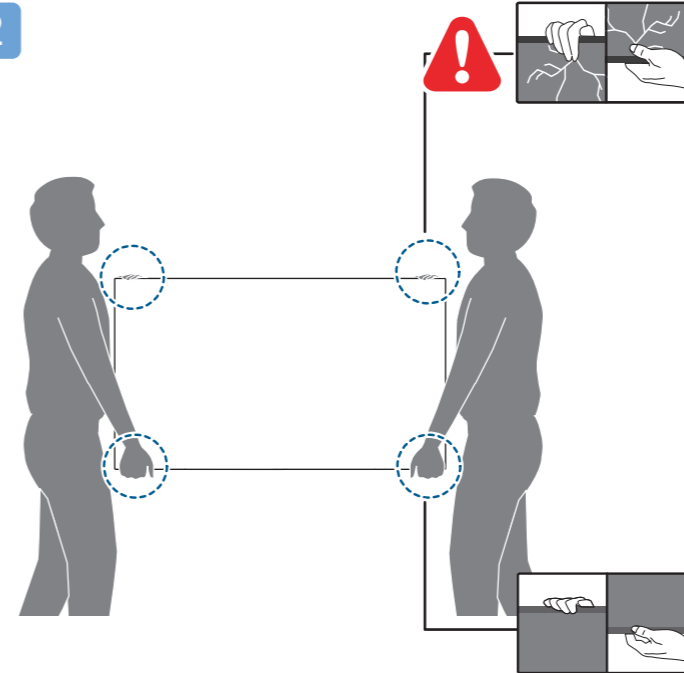

3

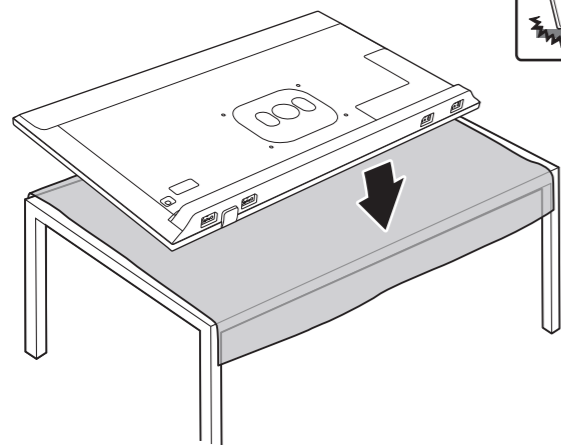
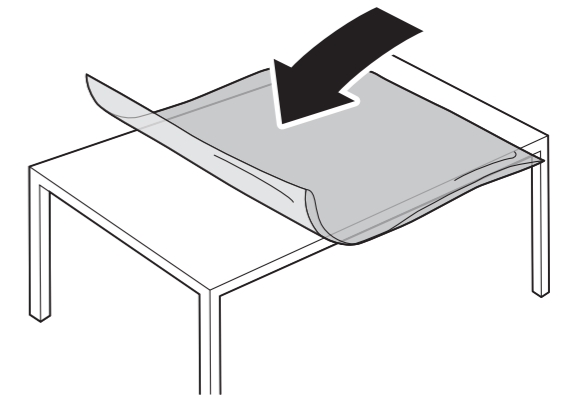

4

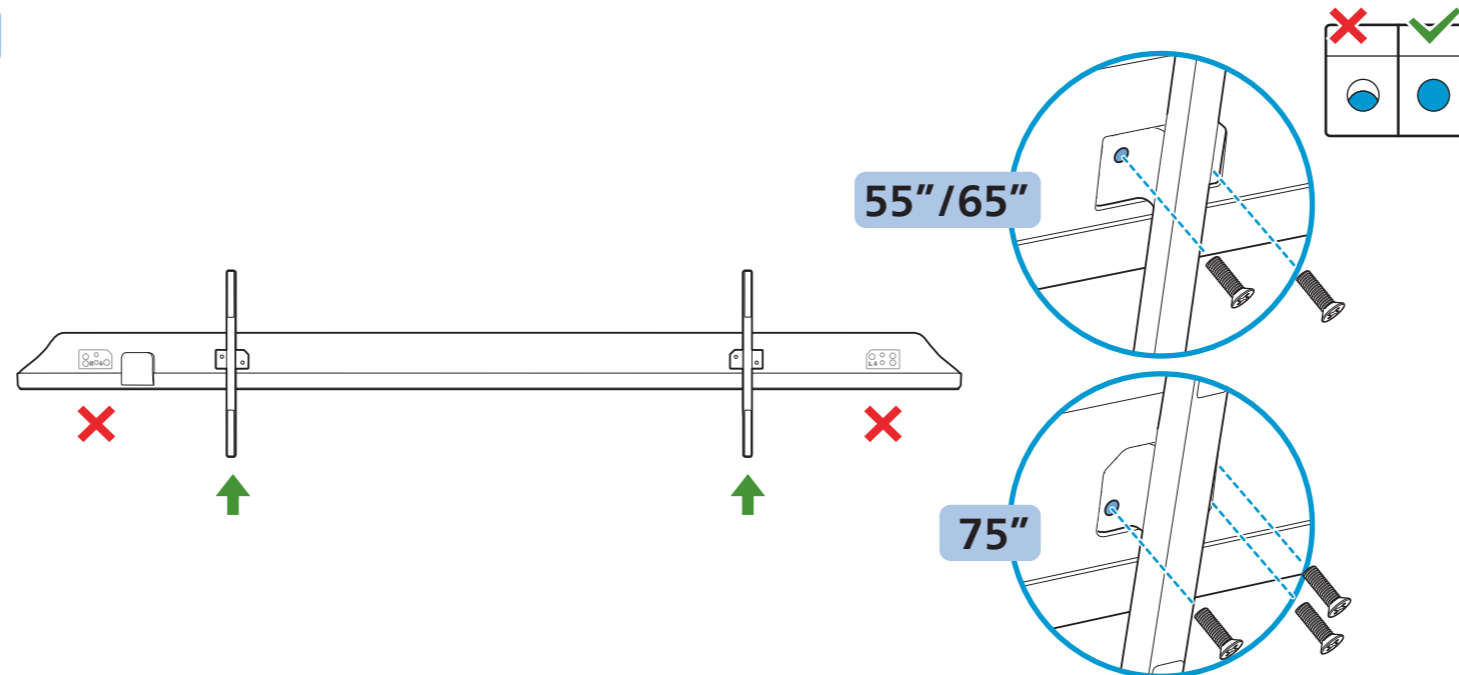

5

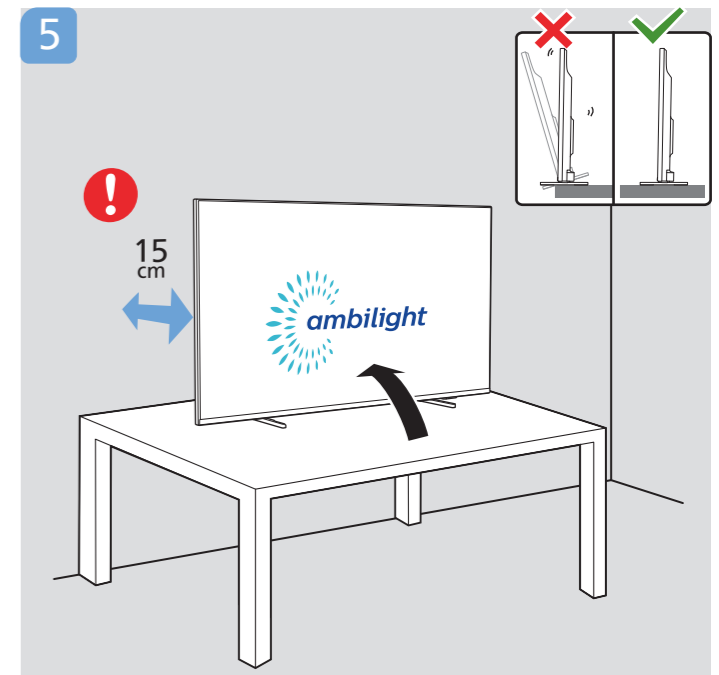



English Read the safety instructions.
Български Прочетете инструкциите за безопасност.
Čeština Přečtěte si bezpečnostní pokyny.
Hrvatski Pročitajte sigurnosne upute.
Dansk Læs sikkerhedsforskrifterne.
Deutsch Lesen Sie die Sicherheitshinweise.
Ελληνικά Διαβάστε τις οδηγίες ασφαλείας.
Eesti Lugege ohutusnõudeid.
Español Lea las instrucciones de seguridad.

Français Lisez les consignes de sécurité.
Italiano Leggere le istruzioni di sicurezza.
Қазақша Қорғаныстық нұсқаулар.
Latviešu Izlasiet drošības norādījumus.
Lietuvių Perskaitykite saugos instrukcijas.
Magyar Olvassa el a biztonsági utasításokat.
Nederlands Lees de veiligheidsvoorschriften.
Norsk Les sikkerhetsforskriftene.
Polski Zapoznaj się z instrukcjami bezpieczeństwa.

Português Leia as instruções de segurança.
Română Citiți instrucțiunile de siguranță.
Русский Читайте инструкции по технике безопасности.
Срpski Pročitajte bezbednosna uputstva.
Slovenščina Preberite varnostna navodila.
Slovenský Prečítajte si bezpečnostné pokyny.
Suomi Lue turvaohjeet.
Svenska Läs säkerhetsinstruktionerna.
ภาษาไทย โปรดอ่านคำแนะนำด้านความปลอดภัย

Türkçe Güvenlik talimatlarını okuyun.
Українська Читайте інструкції з техніки безпеки.
العربية قراءة تعليمات السلامة.
עברית קראו את הוראות הבטיחות



Register your product and get support at www.philips.com/TVsupport

