

Booklet available in English on
Heft in deutscher Sprache erhältlich auf
Livret disponible en français sur
Libretto disponibile in italiano su
Folleto en español disponible en
如需中文版手册, 请访问



FR

**DONNEZ
OU
RECYCLEZ**



ASSOCIATION
OU



MAGASIN
OU



DÉCHÈTERIE

Adresses sur quefairemesdechets.fr



LEGO.com/sustainable-packaging

LEGO® VIP

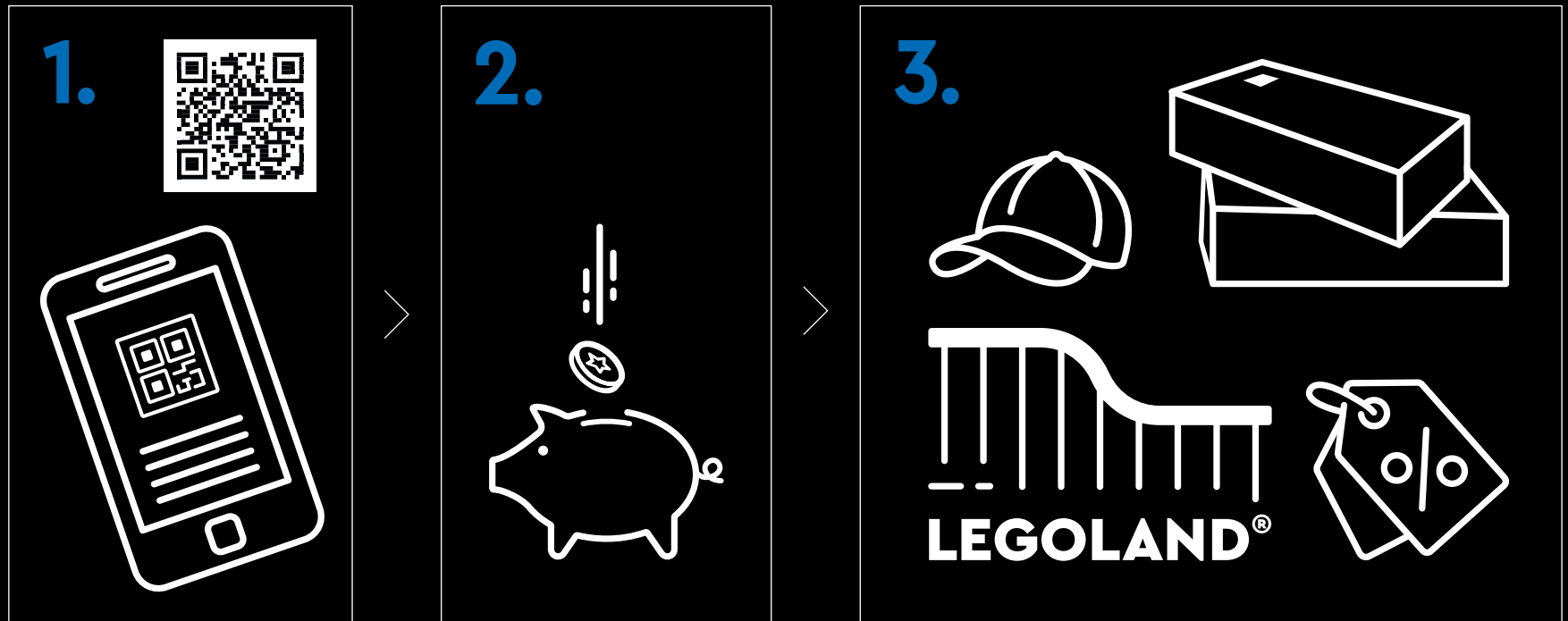

1. Sign up **2.** Earn points for purchases **3.** Redeem points for rewards, experiences, discounts & more | **1.** Melde dich an **2.** Sammle Punkte bei jedem Kauf **3.** Löse die Punkte für Belohnungen, Erlebnisse, Rabatte und Ähnliches ein | **1.** Inscrivez-vous **2.** Gagnez des points lors de vos achats **3.** Échangez vos points contre des récompenses, des expériences, des remises et bien plus encore | **1.** Iscriviti **2.** Guadagna punti con i tuoi acquisti **3.** Riscatta punti per premi, esperienze, sconti e altro ancora | **1.** Regístrate **2.** Gana puntos por tus compras **3.** Canjea puntos por recompensas, experiencias, descuentos y mucho más | **1.** Registe-se **2.** Ganhe pontos em compras **3.** Troque os pontos para prémios, experiências, descontos e muito mais | **1.** 注册 **2.** 购物赚积分 **3.** 用积分兑换奖励、体验、折扣等 | **1.** Zarejestruj się **2.** Zdobywaj punkty za zakupy **3.** Wymieniaj punkty na rabaty, przygody i inne nagrody | **1.** Zaregistrujte se **2.** Sbírejte body za nákupy **3.** Vyměňujte body za odměny, zážitky, slevy a spoustu dalšího | **1.** Zaregistrujte se **2.** Získavajte body za nákupy **3.** Uplatnite si body a získajte odmeny, rôzne zážitky, zľavy a ešte viac | **1.** Regisztrálj **2.** Szerezz pontokat minden vásárlással **3.** Váltsd be pontjaidat jutalmakra, élményekre, kedvezményekre és egyebekre | **1.** Înscric-te **2.** Câștigă puncte pentru achiziții **3.** Valorifică puncte pentru recompense, experiențe, reduceri și multe altele | **1.** Регистрируйте се **2.** Получайте точки за покупки **3.** Используйте точки за награды, услуги, отстъпки и т.н. | **1.** Reģistrējies **2.** Pelni punktus par pirkumiem **3.** Izmanto punktus, lai saņemtu balvas, izklaides iespējas, atlaides un daudz ko citu | **1.** Registreeru **2.** Teeni ostude eest punkte **3.** Lunasta punktide eest preemiad, elamused, allahindlused ja muu | **1.** Užsiregistruokite **2.** Pelnykite taškų už pirkinius **3.** Panaudokite taškus atlygiui, funkcijoms, nuolaidoms ir ne tik



WELCOME TO LEGO® ART

● From humble roots in pulp prints to a **cultural phenomenon** – the comic book genre has continually transformed storytelling through art. With innovative use of **graphic design** and **printing techniques**, **complex storylines** and **strongly defined characters**, it continues to influence pop art and other media. And now, for the fans, we're taking it **one step further** – create your own **Spider-Man comic panel** and immerse yourself in the **LEGO® Art experience**. PS: Don't miss the **amazing Soundtrack!**



APPLYING THE BEN DAY PROCESS

● **Did you know?** Comic books released between the 1930s and 1980s were often printed with techniques inspired by the **Ben Day process**. Developed for **newspaper comic strips** in 1879 – by illustrator and painter Benjamin Henry Day Jr. – the technique adds areas of colour to black and white prints by spacing **grids of coloured dots or lines**. Originally used to **save ink** and **reduce costs**, the Ben Day process has inspired generations of artists.

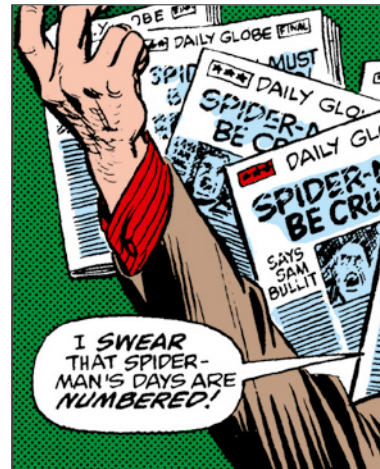
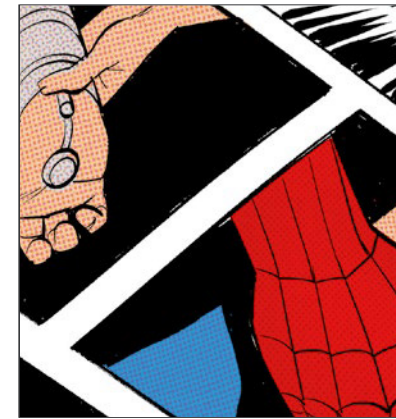
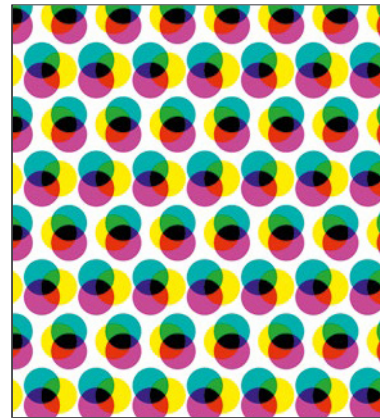

Ben Day-inspired
mid-century pop art

The technique recreated
with LEGO® elements

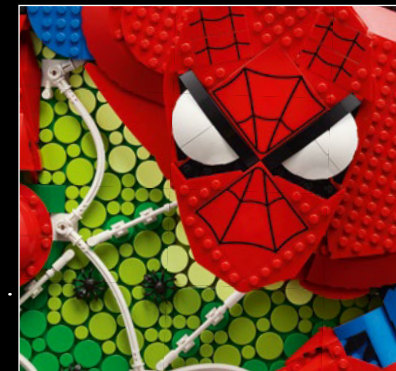

1962

ALONG CAME A SPIDER

● **Peter Parker** --- loveably awkward, gangly teen/friendly neighbourhood super hero --- first appeared in the August 1962 issue of **AMAZING FANTASY #15**. The character won the hearts of Marvel fans and soon featured in his first independent comic book **THE AMAZING SPIDER-MAN (1963) #1**. Written by comic book icon **Stan Lee** and illustrated by **Steve Ditko** and **Sol Brodsky**, the story follows Peter shortly after the death of his beloved **uncle Ben**.

The Amazing Spider-Man continues to weave a web of **dedicated fans** all over the world - Six decades on, he has starred in over **900 AMAZING SPIDER-MAN** comic books, plus features, annuals, collections, newspaper strips, films, games, plays, TV series and more.





Iconic covers through the years

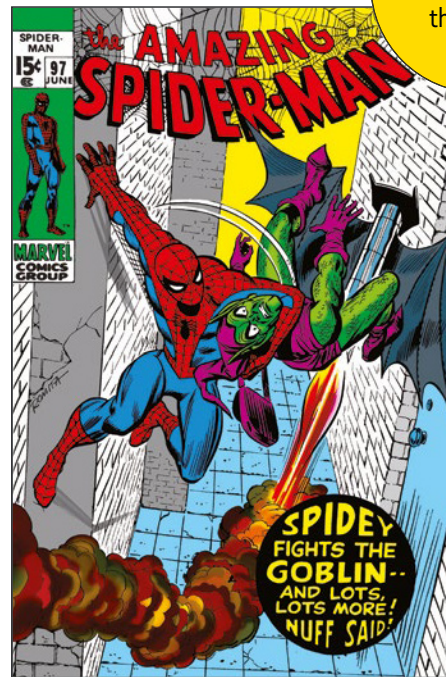



BUILD & DISPLAY – EDITOR'S NOTES:

● **AND NOW...** Before you begin, make sure you find a space **big** enough for the frame – and **sort** your LEGO® bricks. The **step-by-step guide** takes you through a **unique building experience** as you watch your Spider-Man comic panel **come to life!**





 **SOUNDTRACK**
Only in English



IMPORTANT BULLETIN!

● **Don't miss** the guided tour **behind the scenes** of your LEGO® Art Spider-Man set! Scan the QR code to play the **Soundtrack**, with designer interviews and anecdotes from the history of **Spider-Man comic books**.

DO YOU FEEL THAT?

Could it be your **Spidey-builder sense** tingling? You might notice we've used loads of **advanced math** to create a fun building experience – and that's just how Peter Parker would like it.

HAVE A GAS!

Reconnect with your inner **super hero** and spin yourself an Amazing Fantasy web of **creative art**.

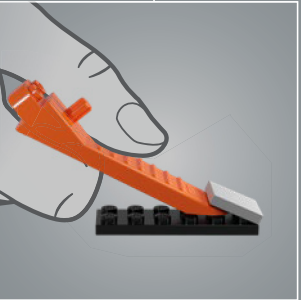
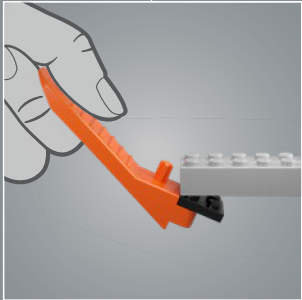
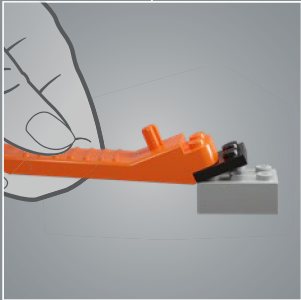
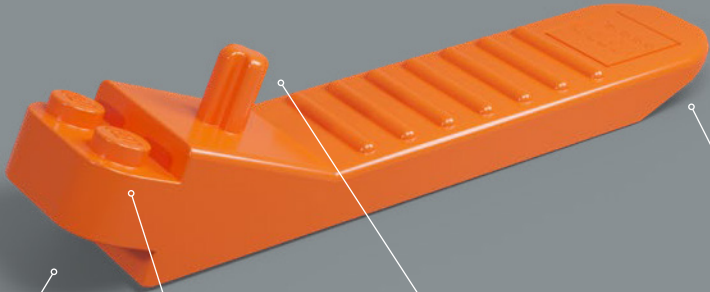

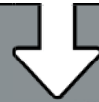
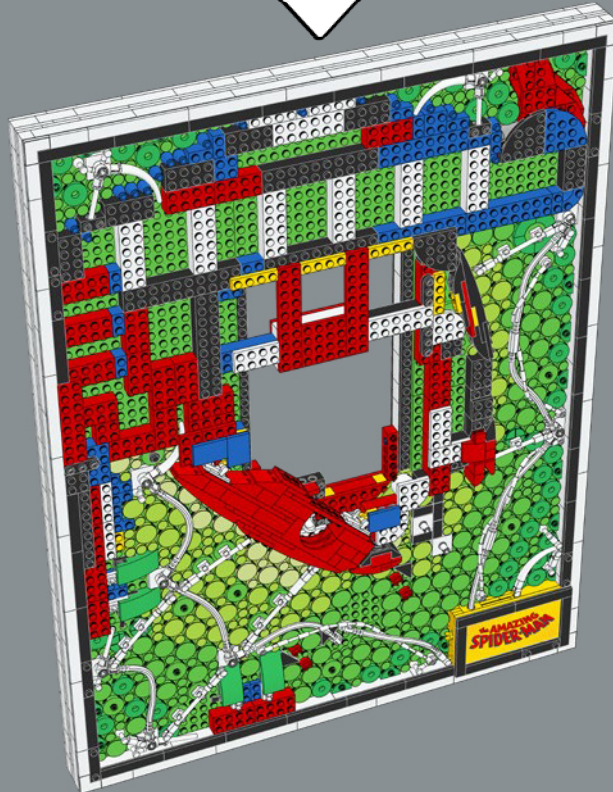
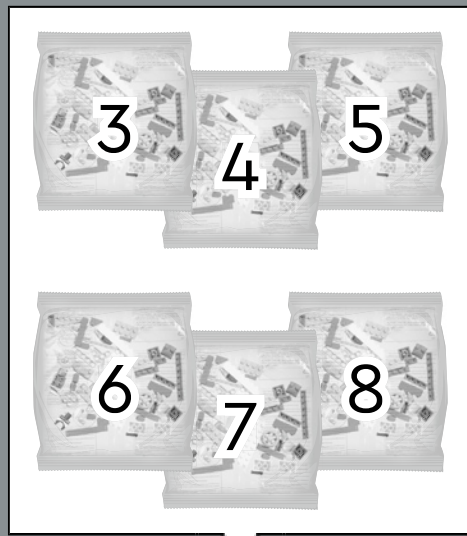
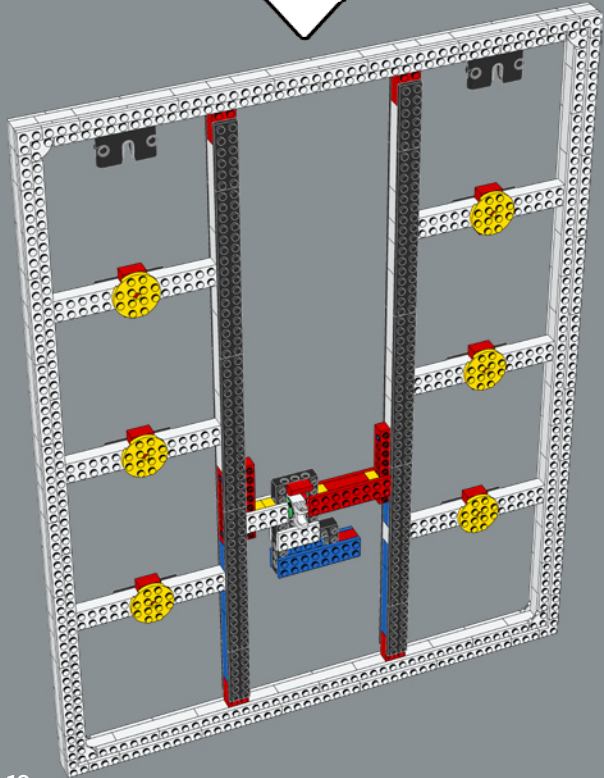
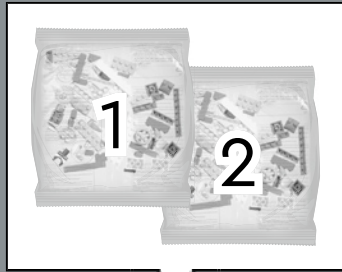

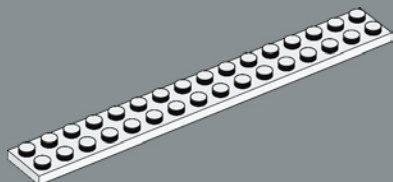
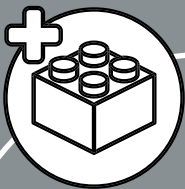

10x

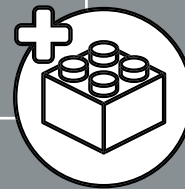
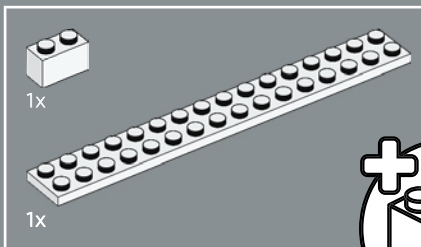

1

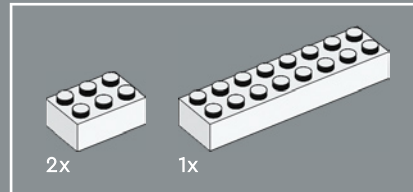
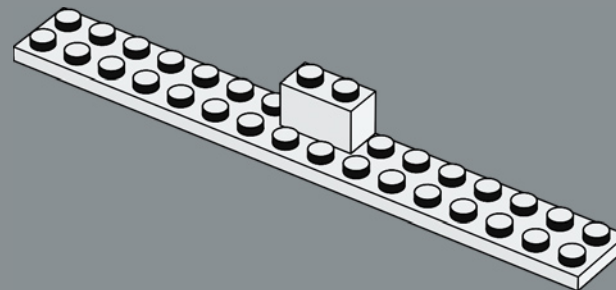

2

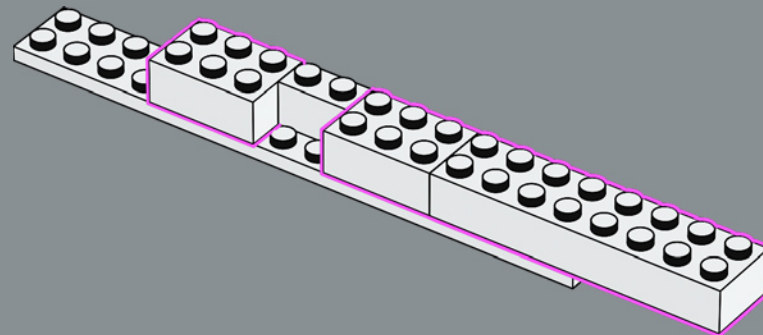

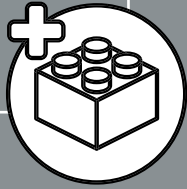
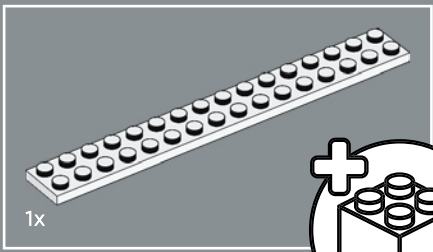

3

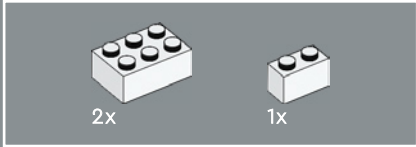
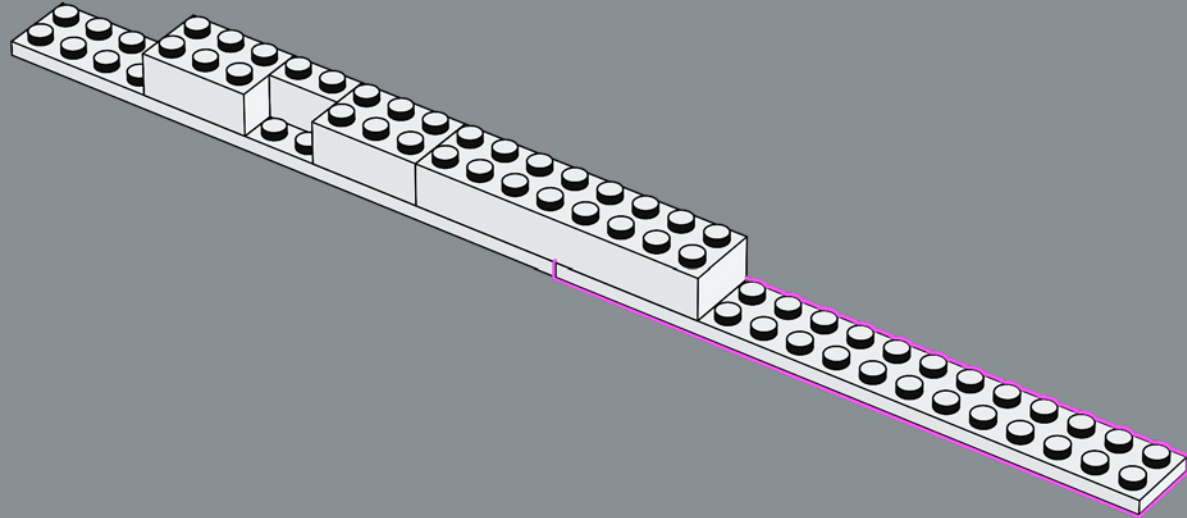

4

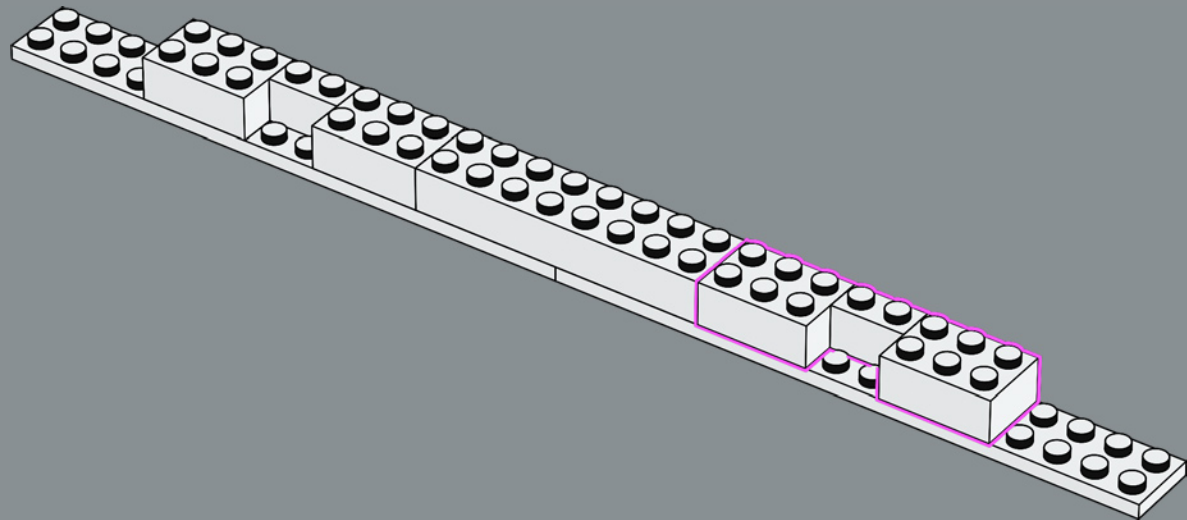

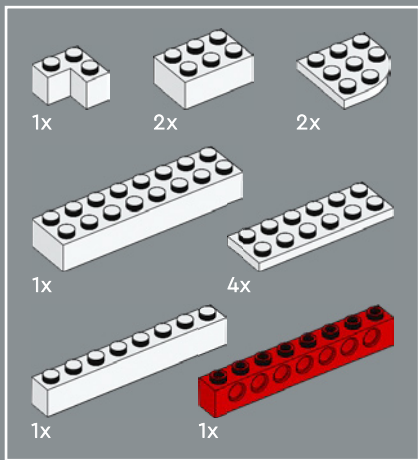

5

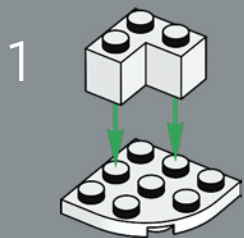

2

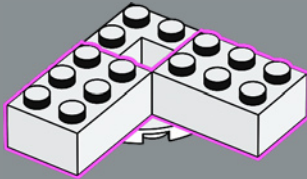

3

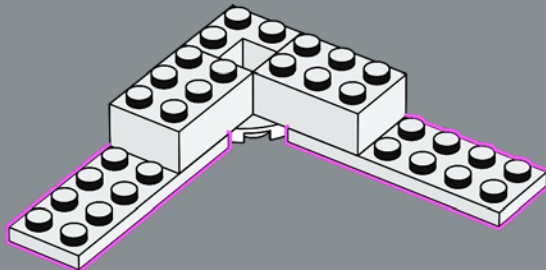

4

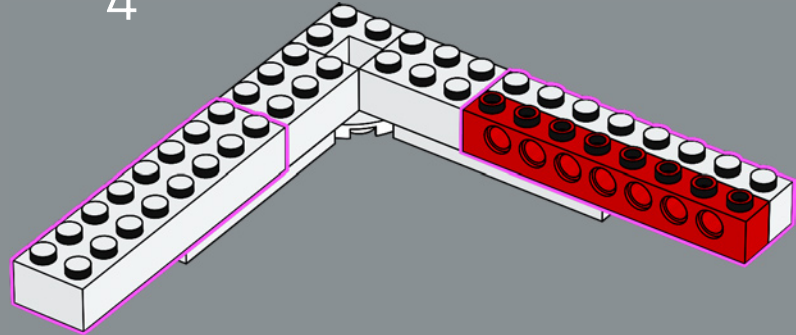

5

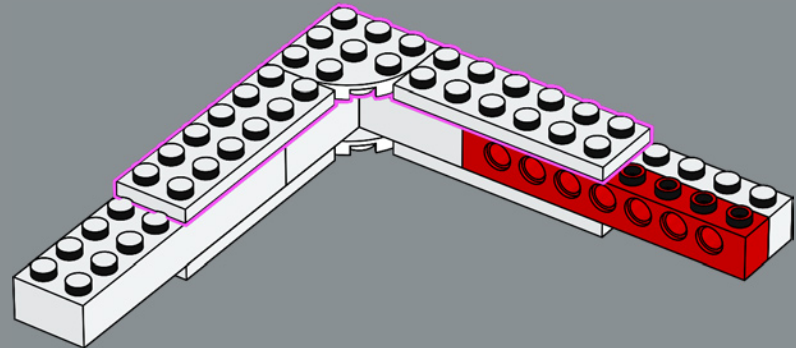

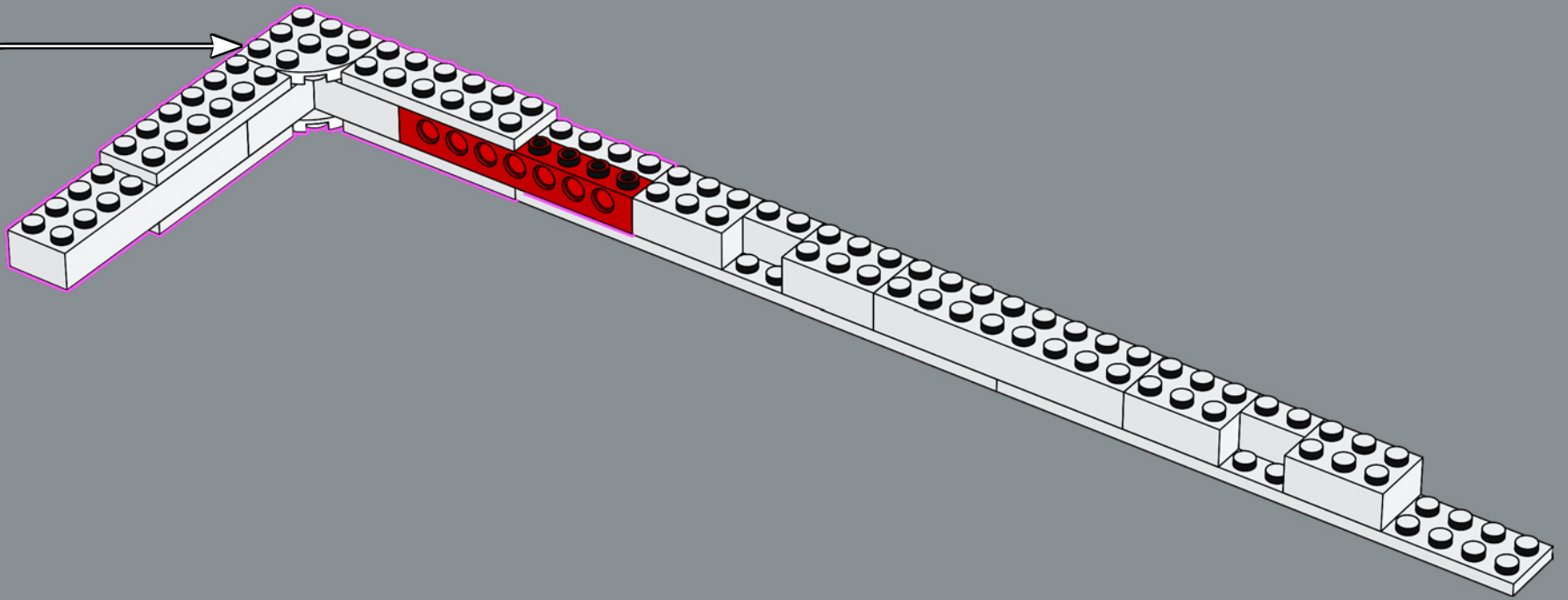

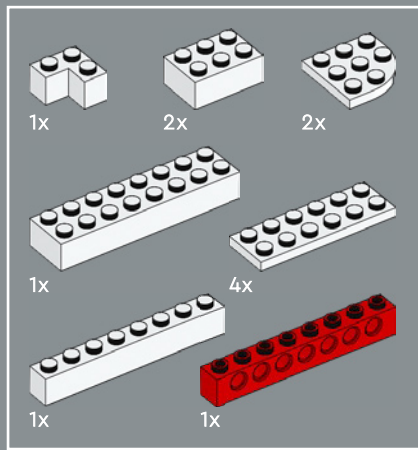

6

1

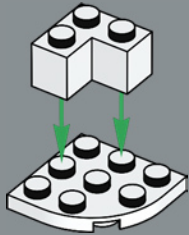

2

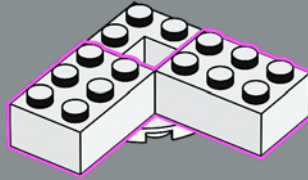

3

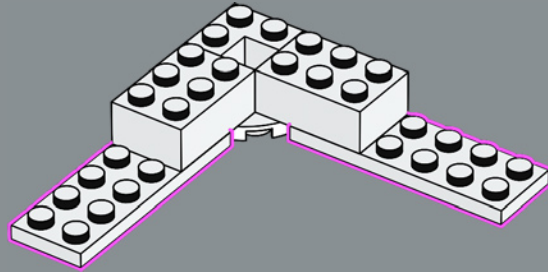

4

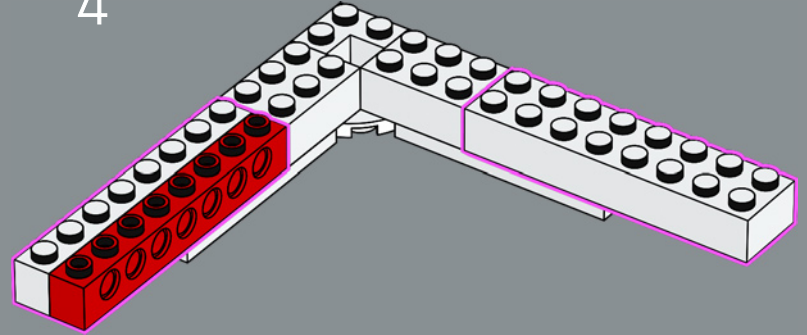

5

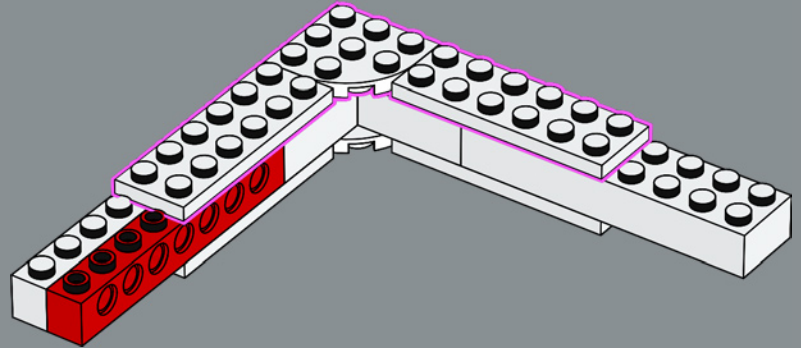

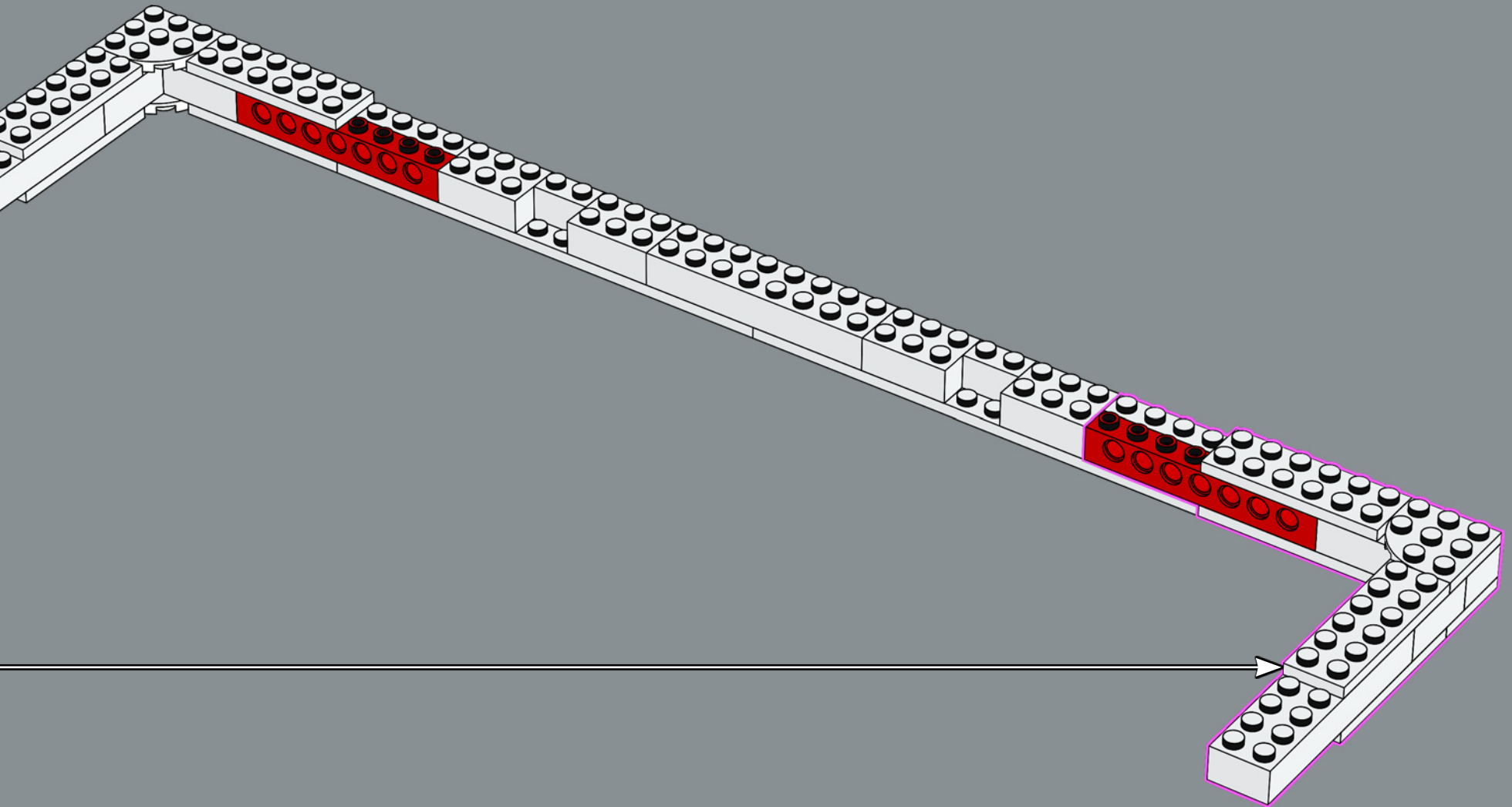

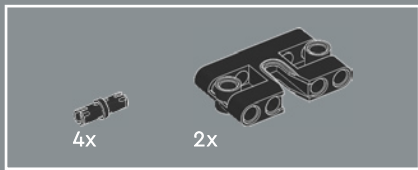

7

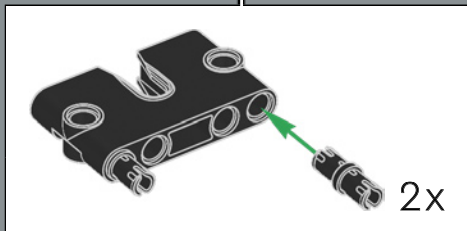
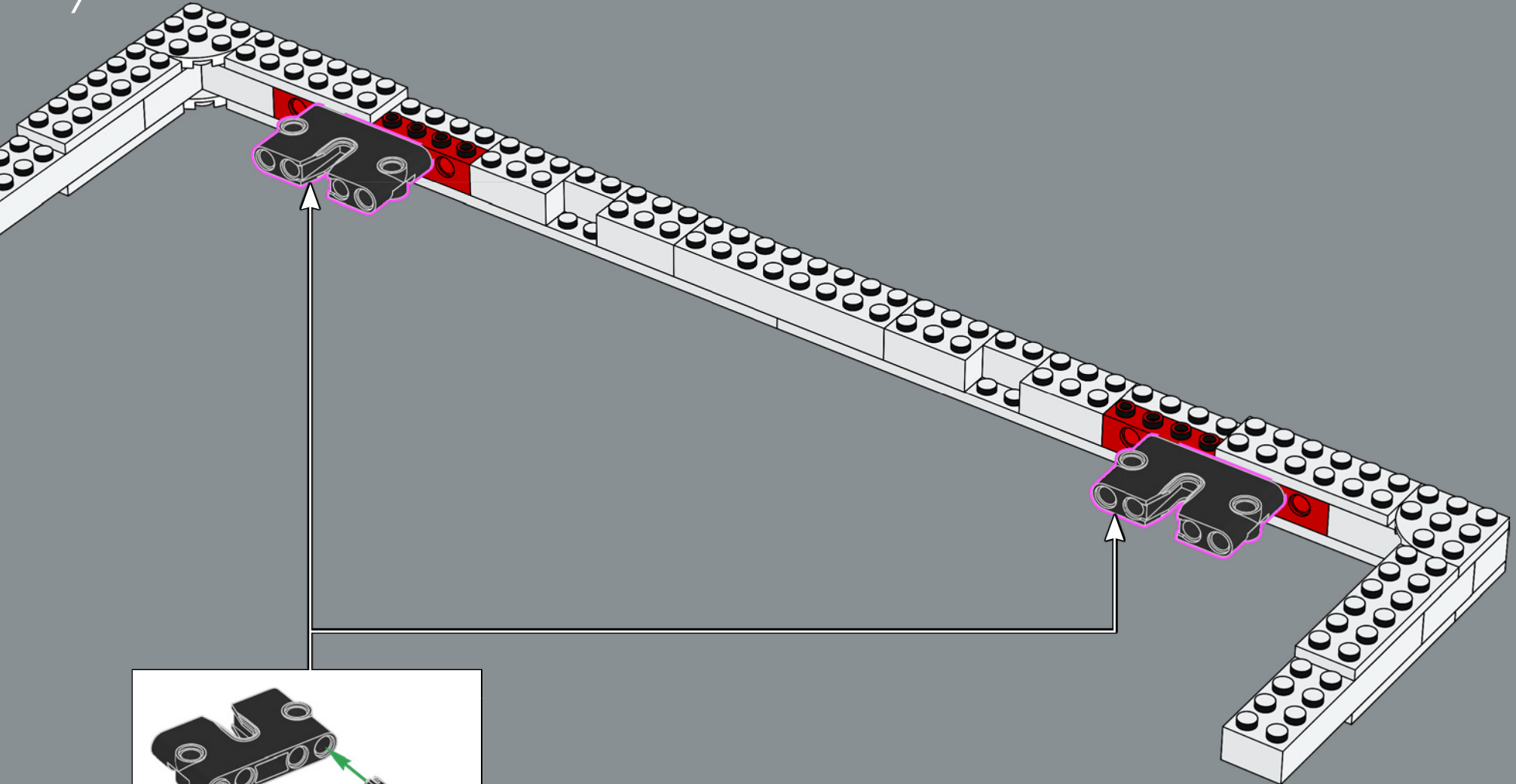

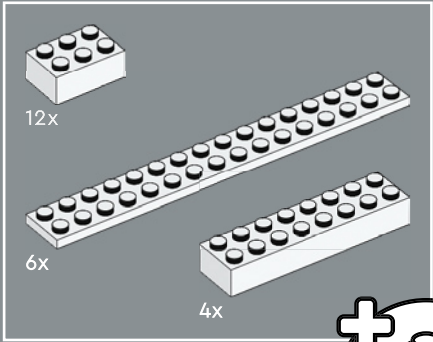
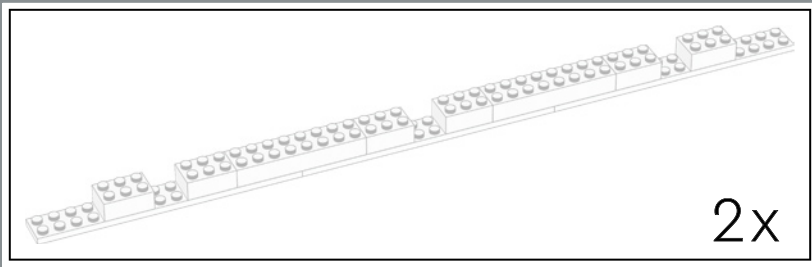

8

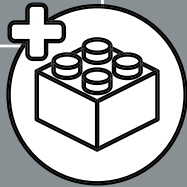

1

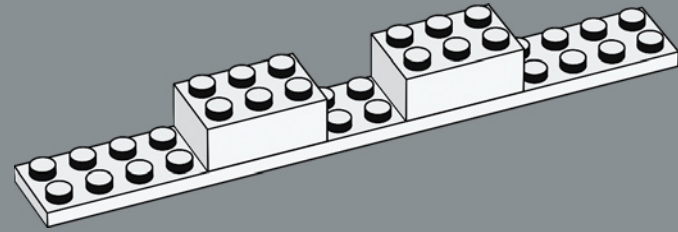

2

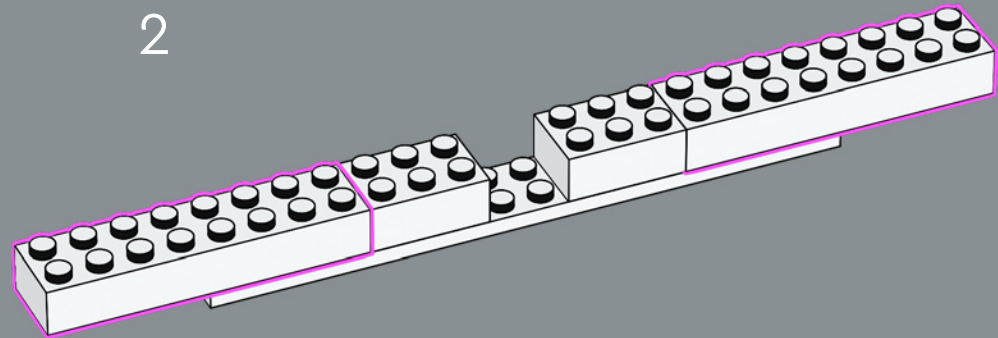

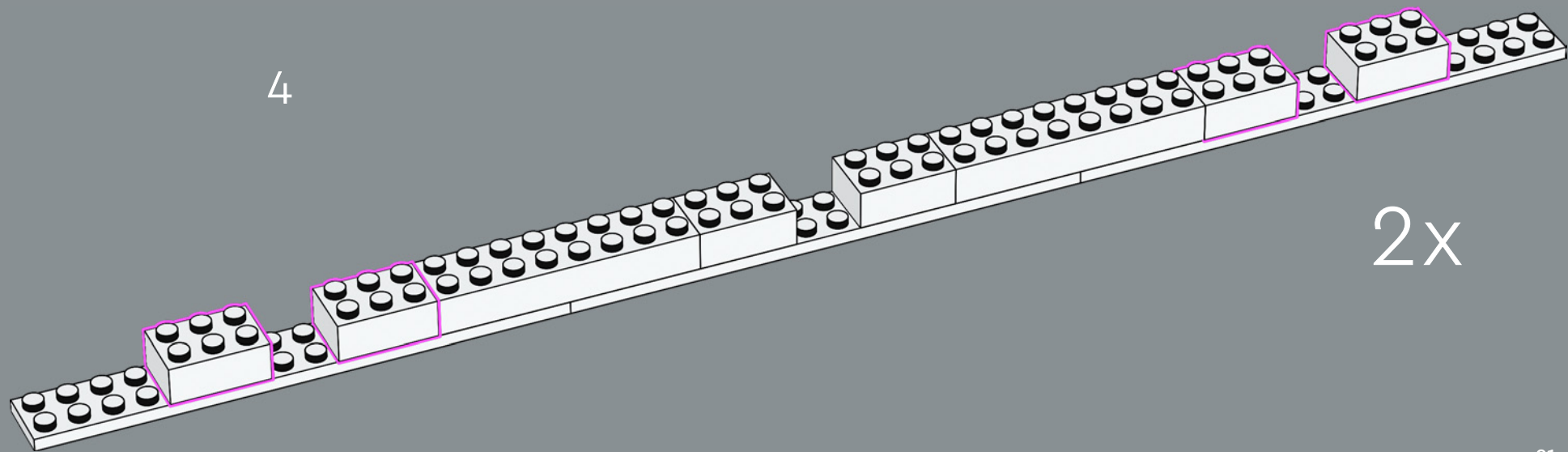
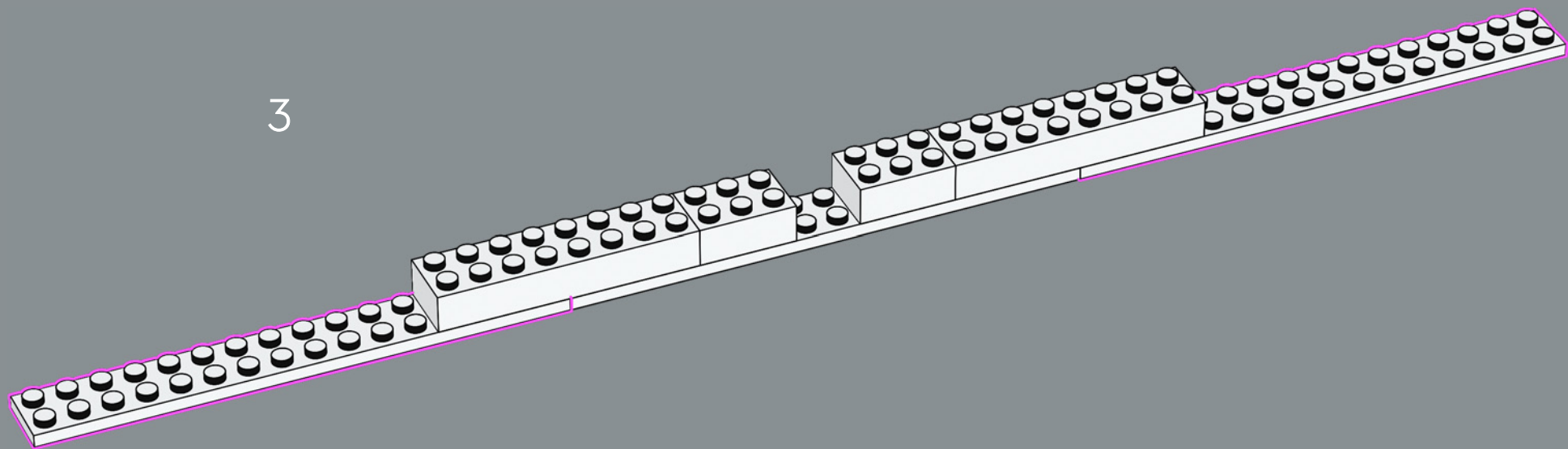

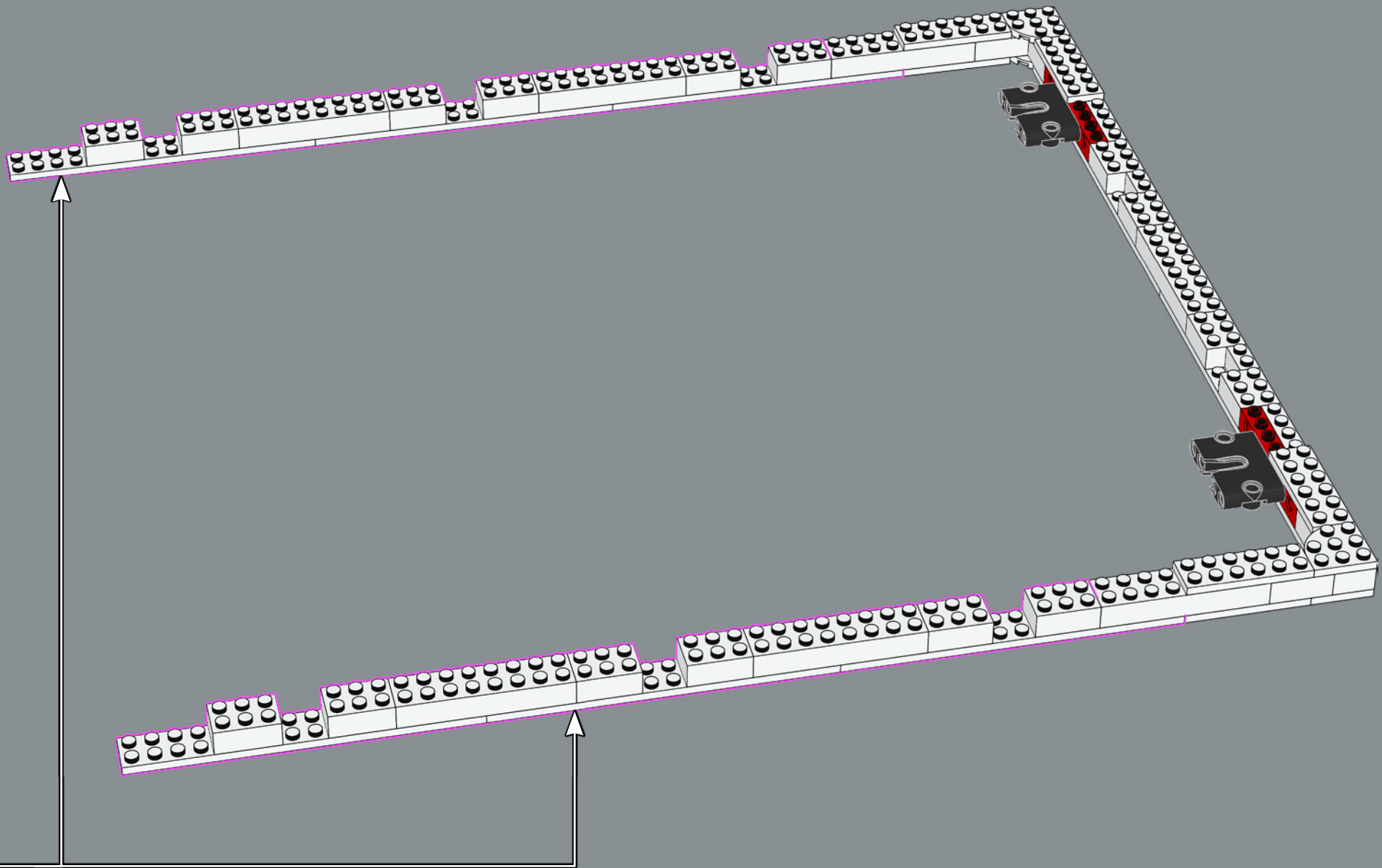

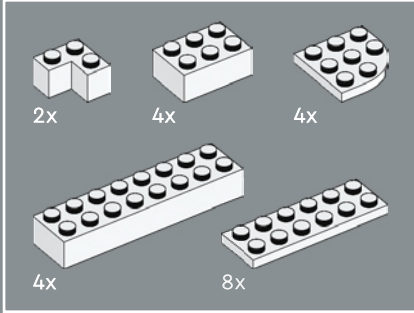
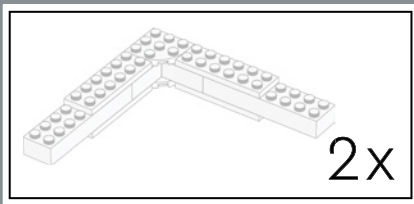

9

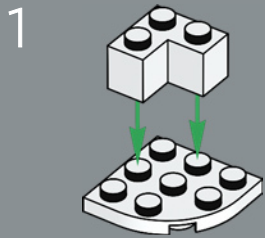

2

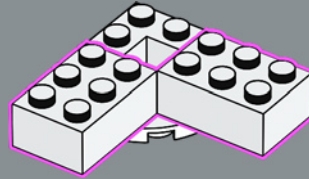

4

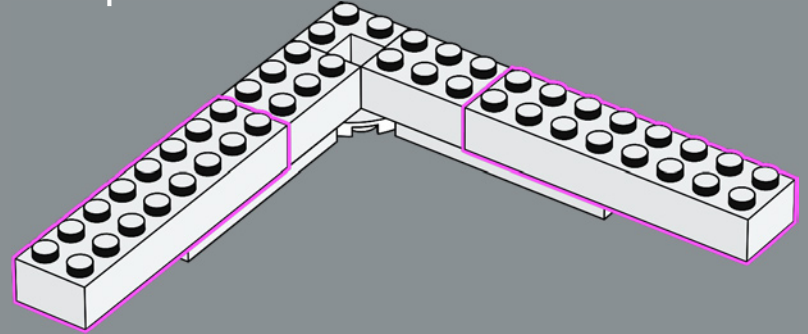

3

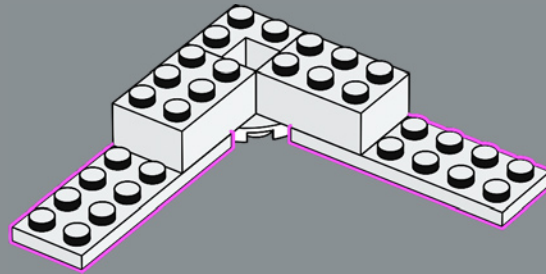

5

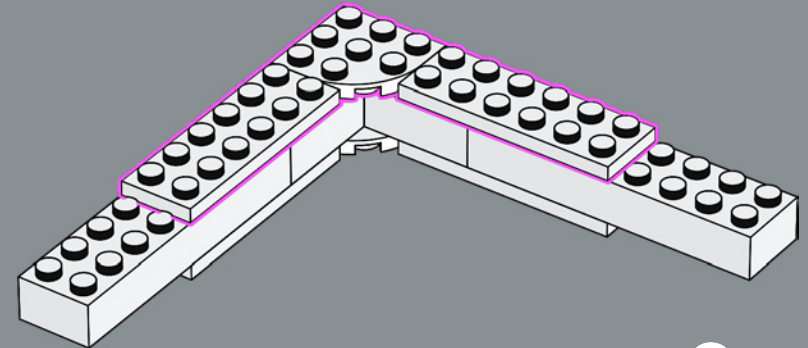

2x

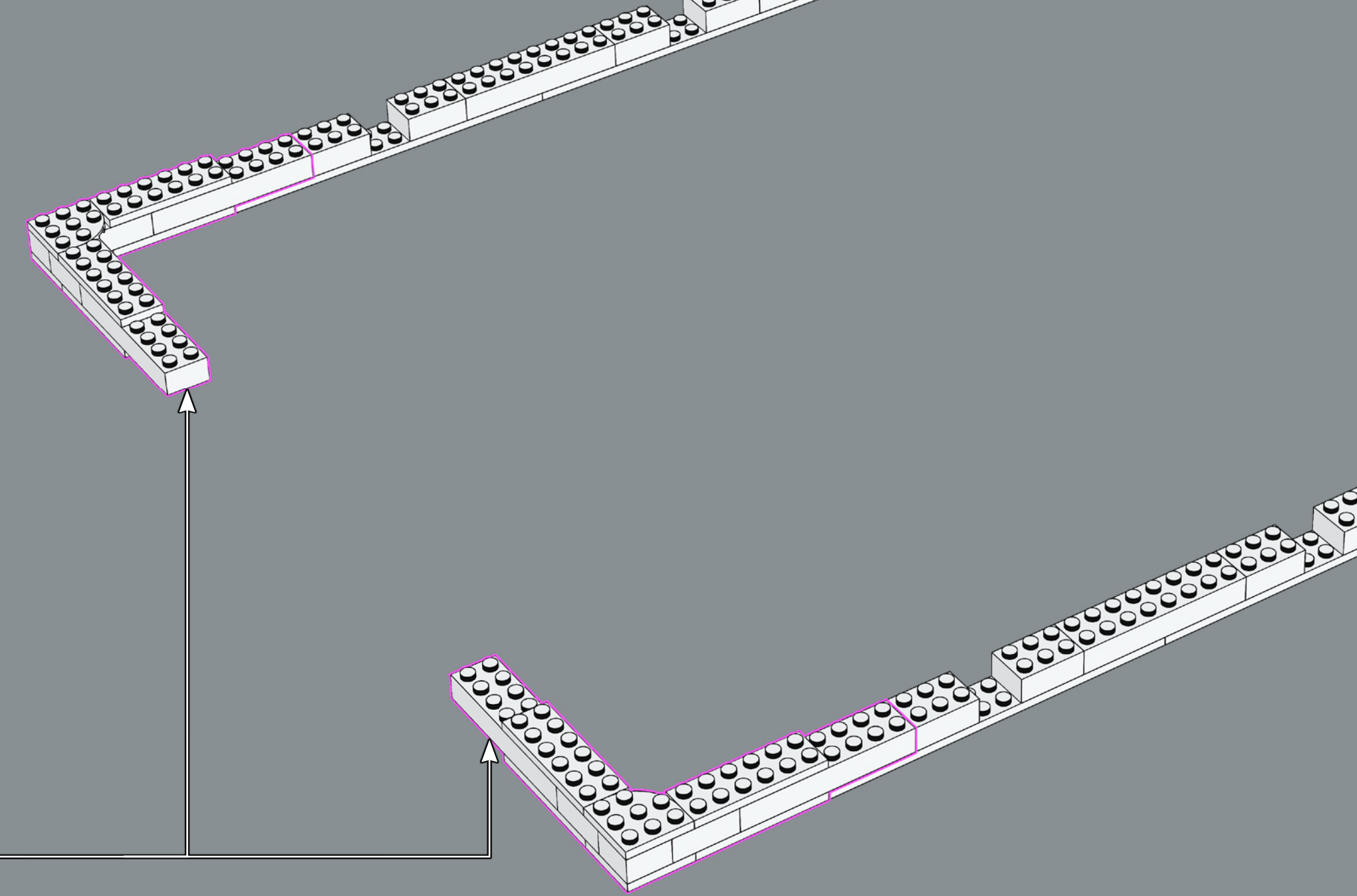

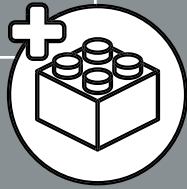
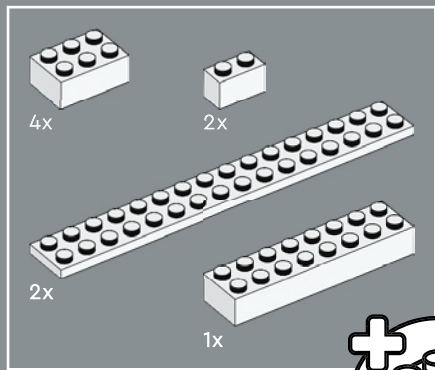

10

1

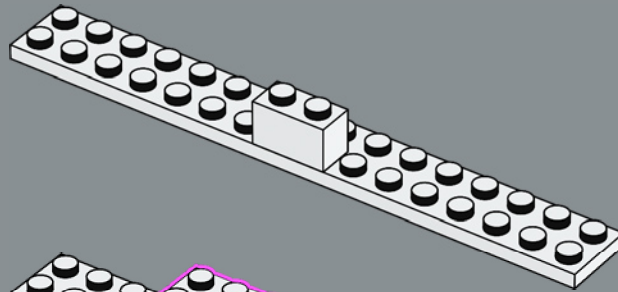

2

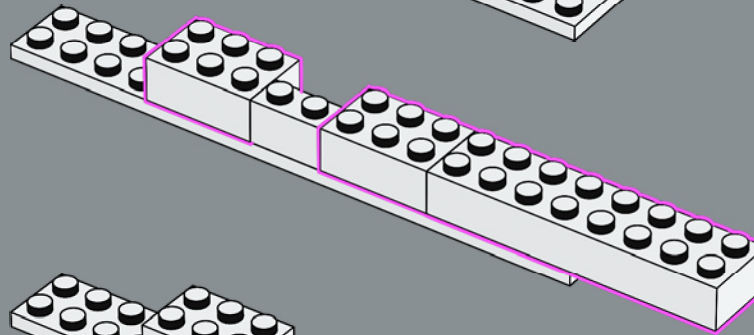

3

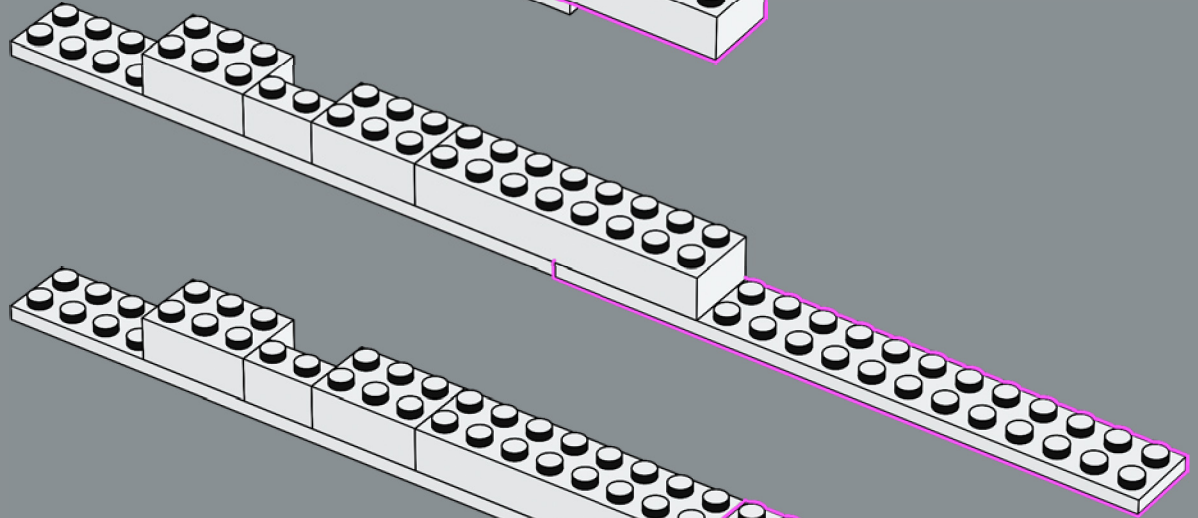

4

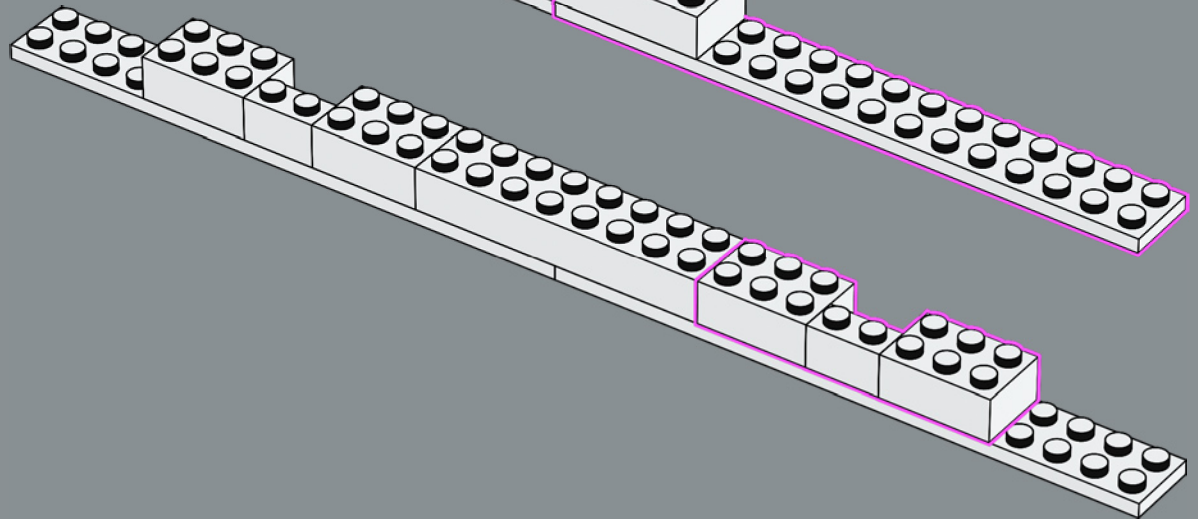

Every comic starts with a frame ...
A comic panel consists of a single
image depicting a frozen moment.
The blank space separating the
panels (a "gutter") creates a
transition between moments in
the story.

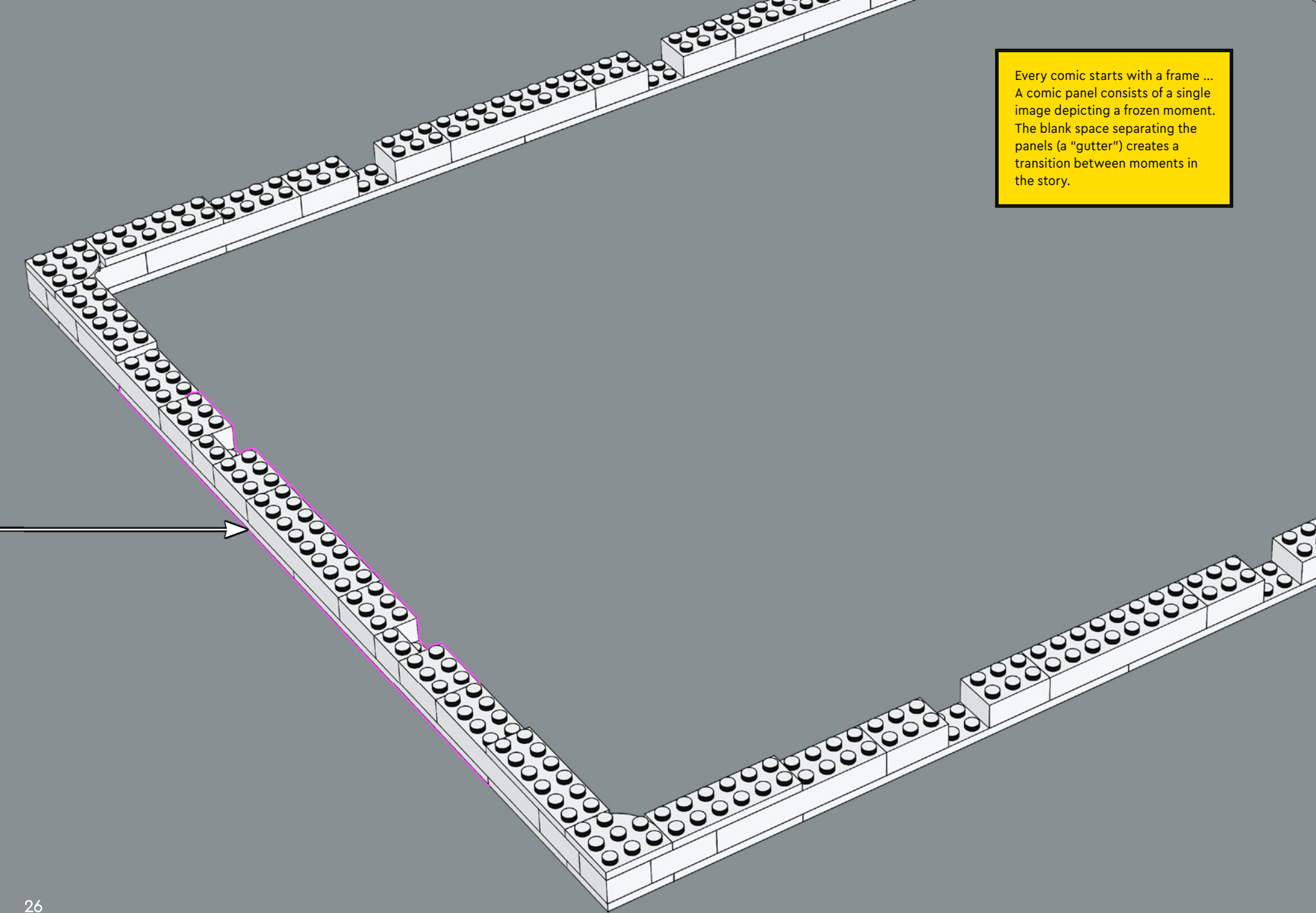

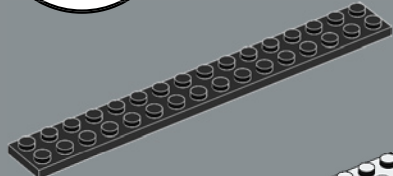
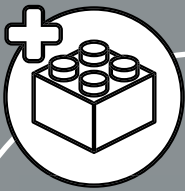

12x

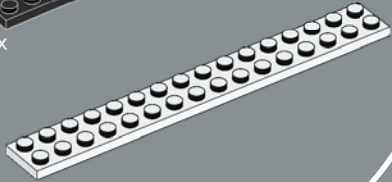

10x

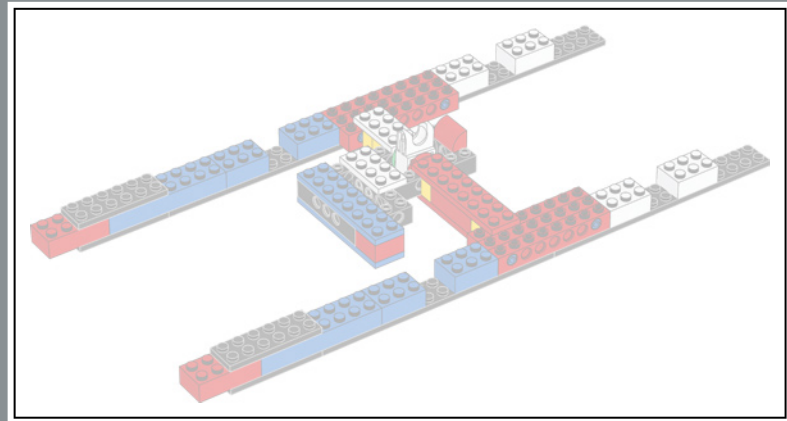

1x



1x

11

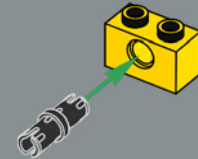

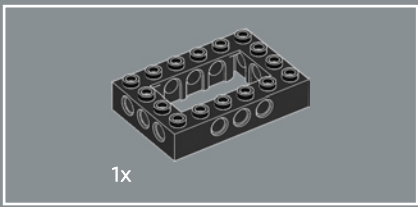

12

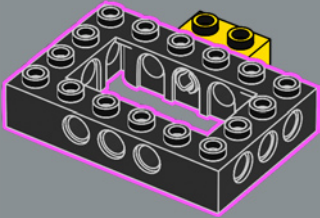

13

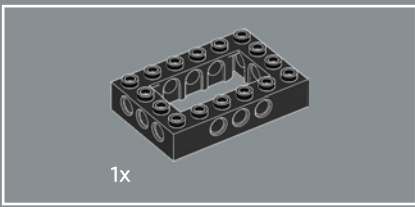
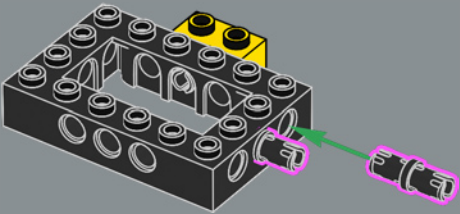

14

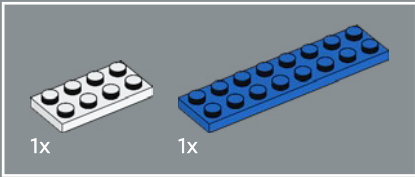
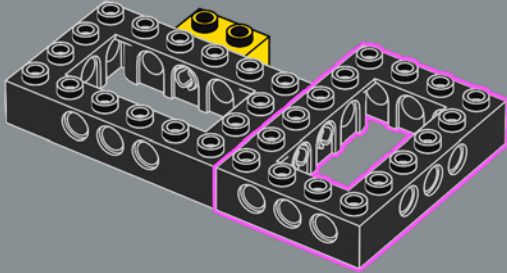

15

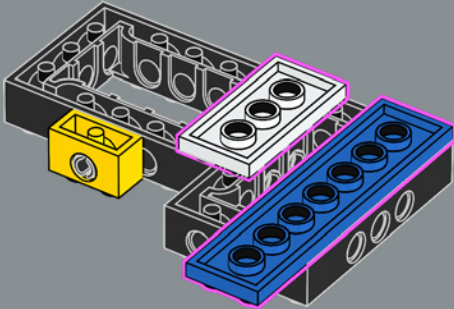

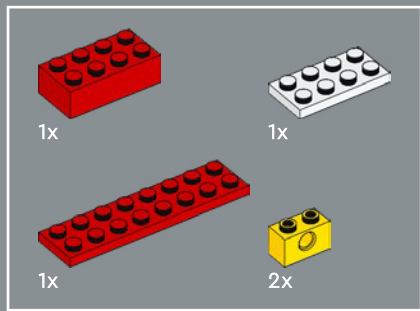

16

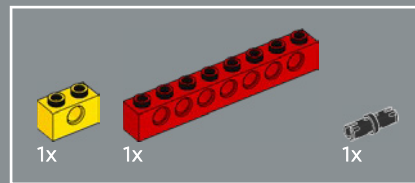
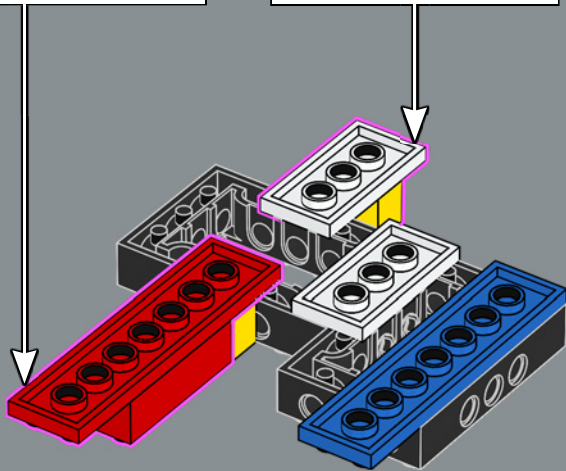
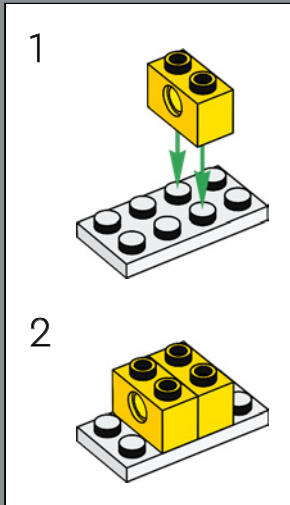
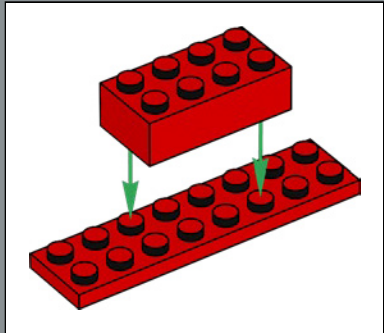

17

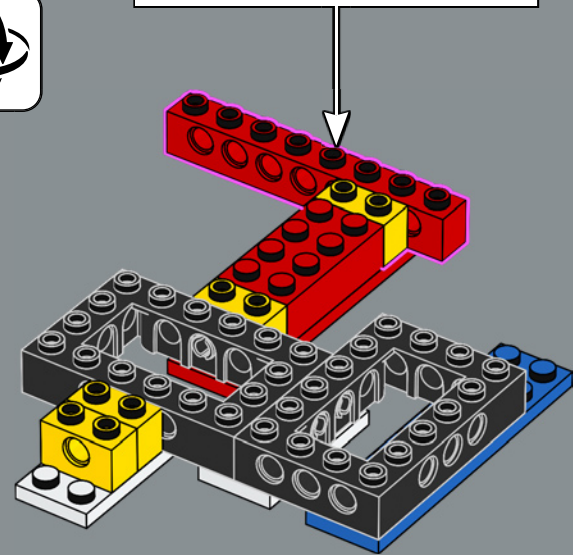
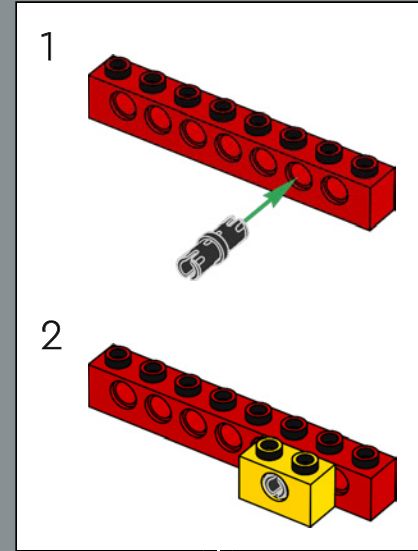

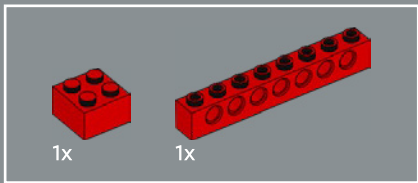

18

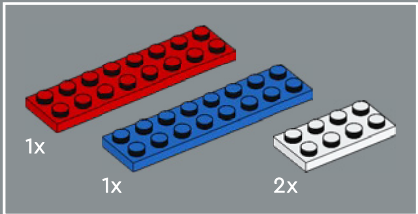
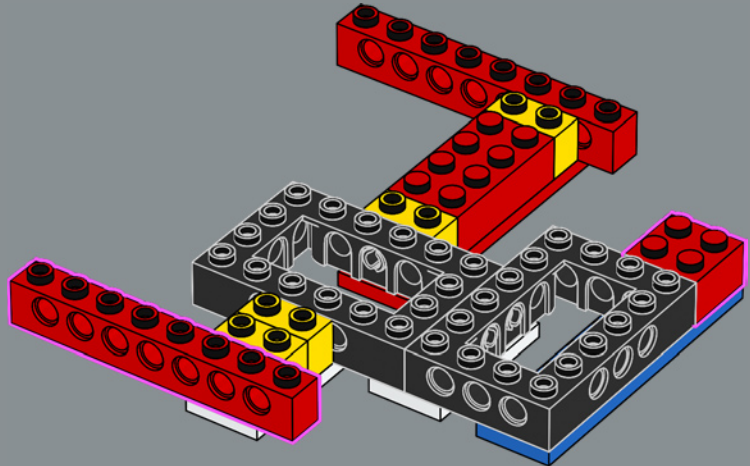

19

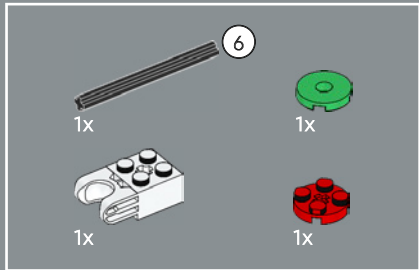
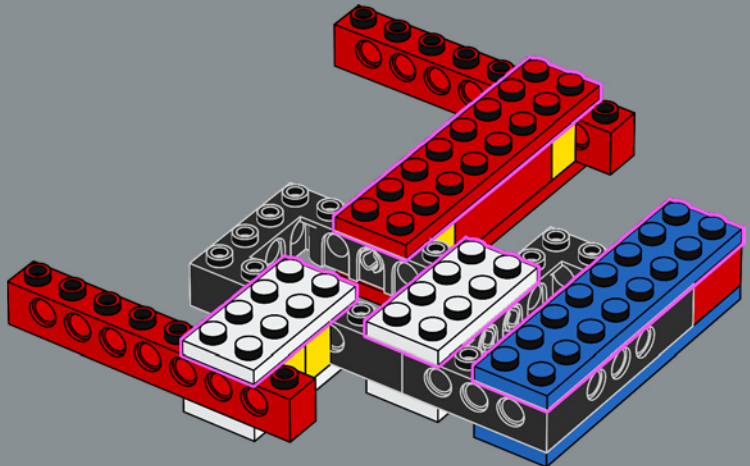

20

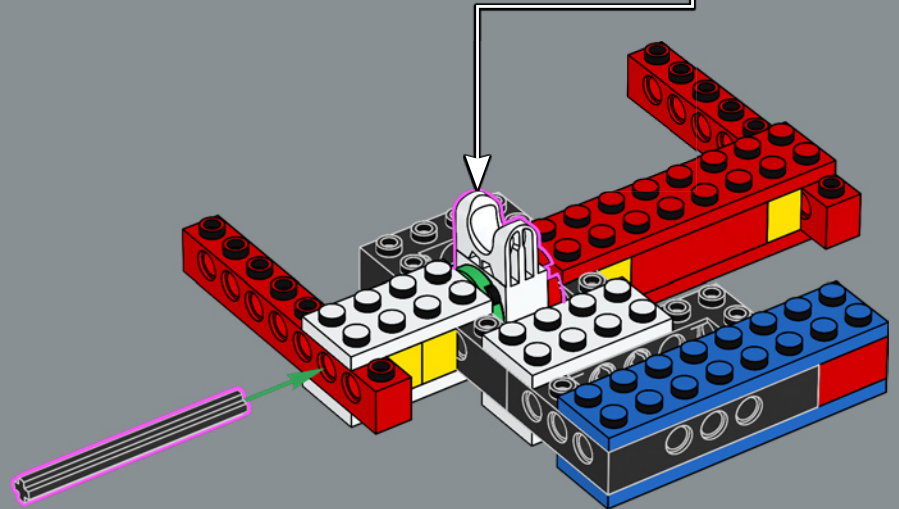
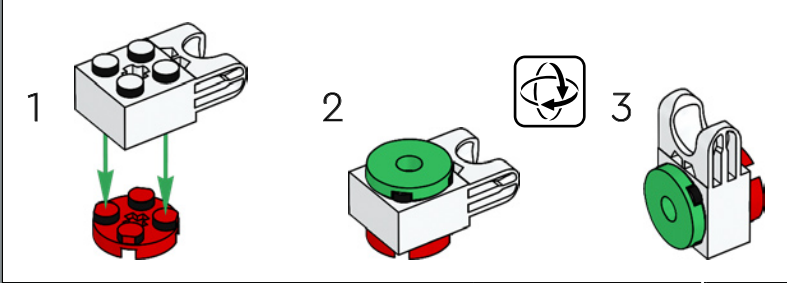

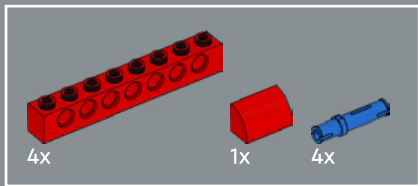

21

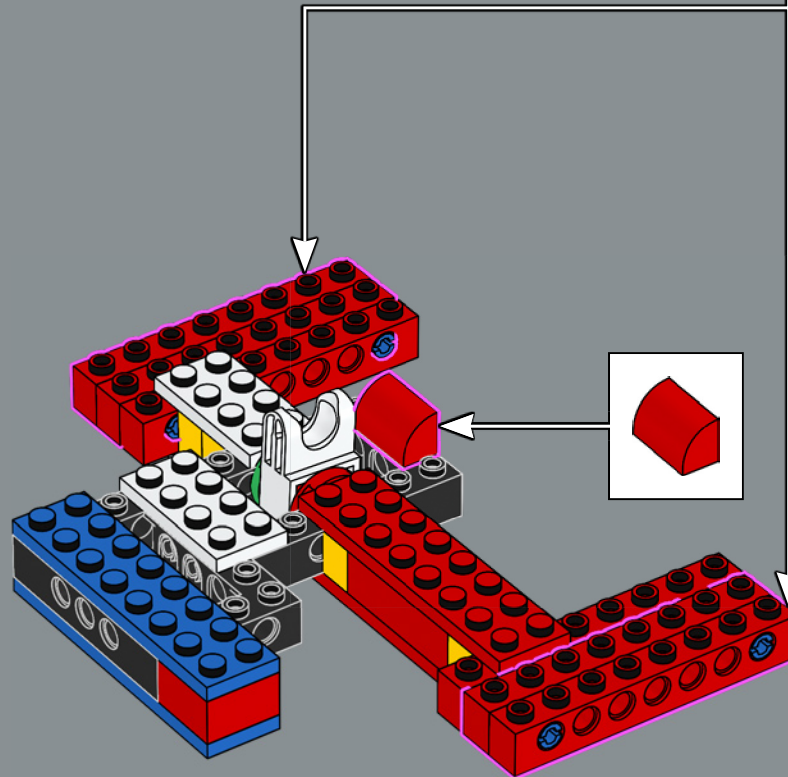
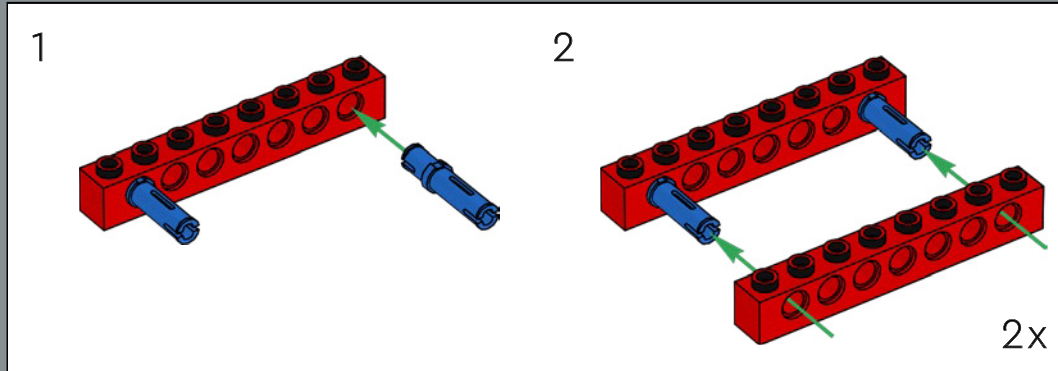

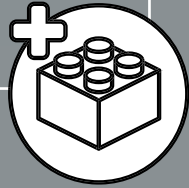
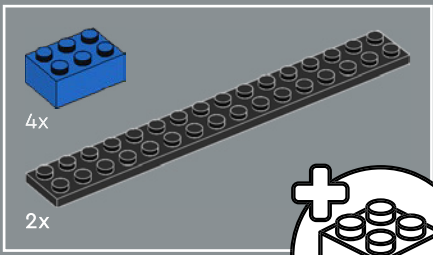

22

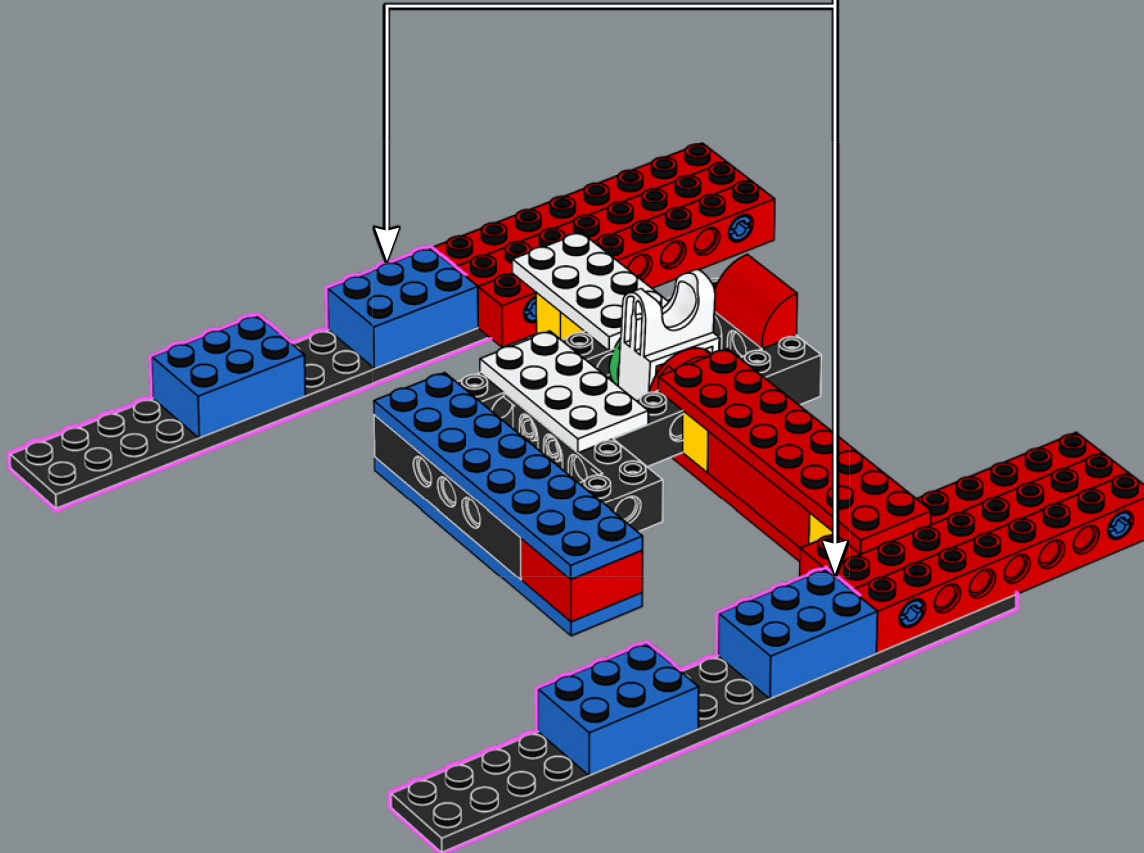
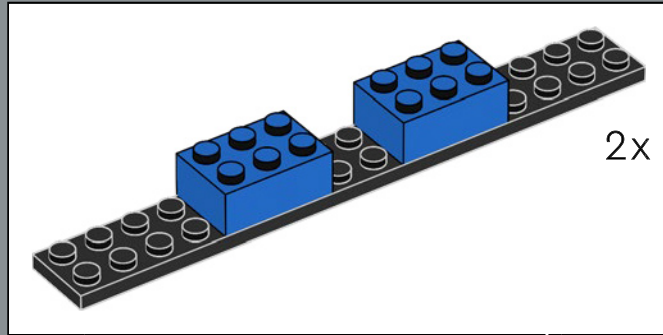

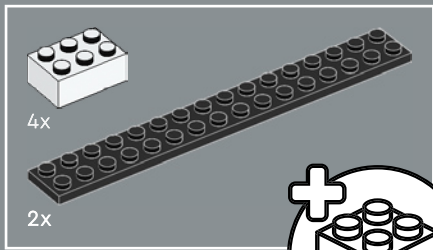

23

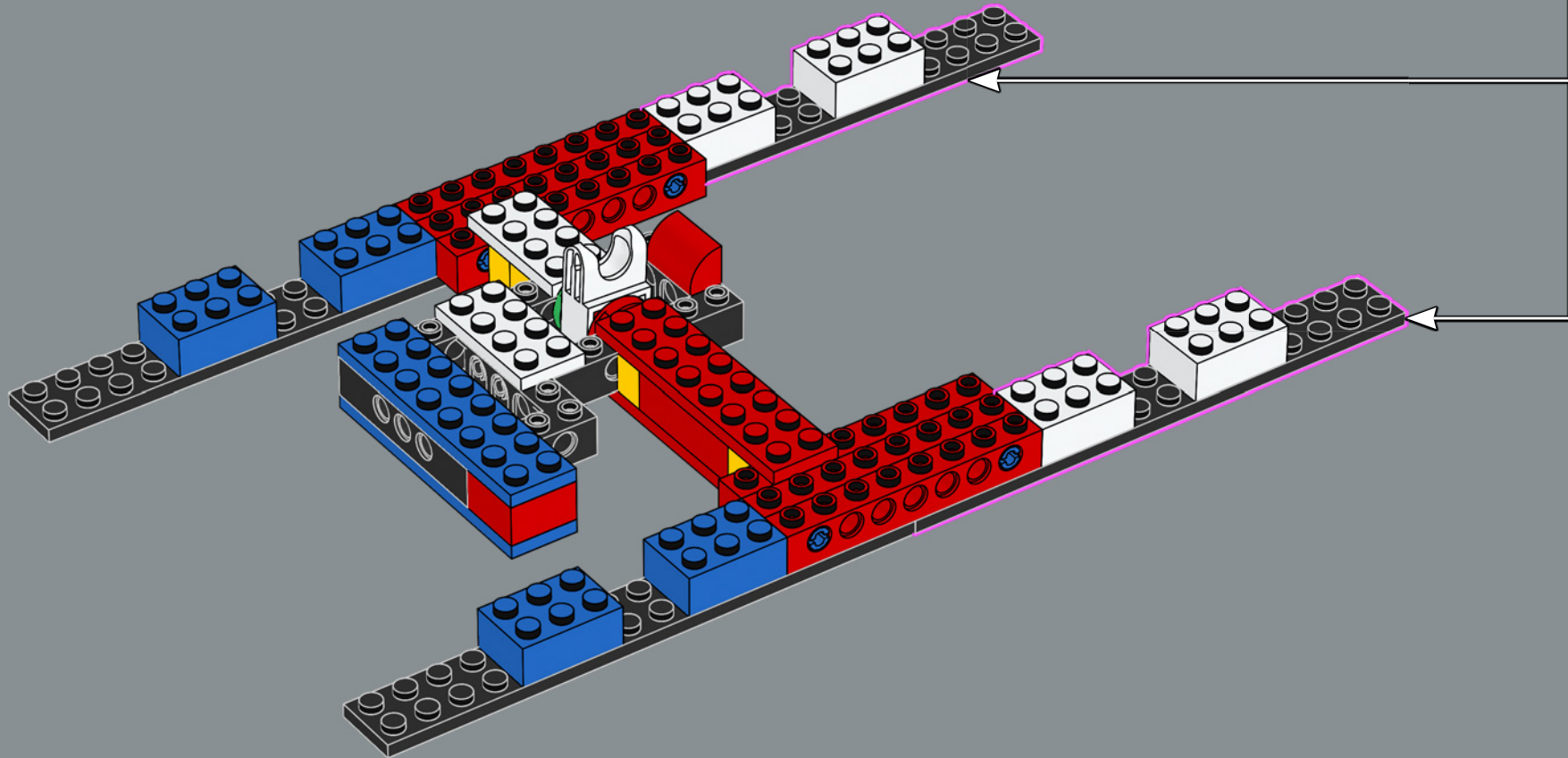
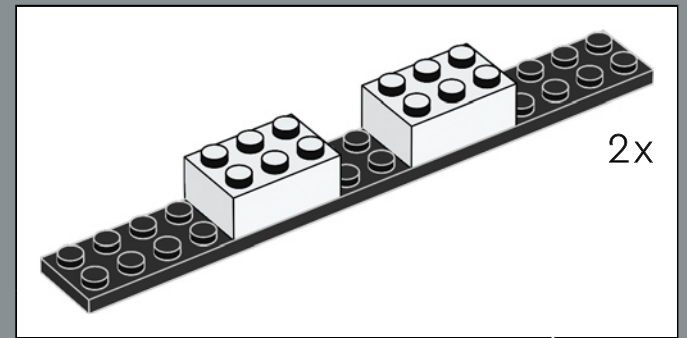
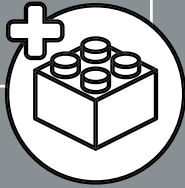

25

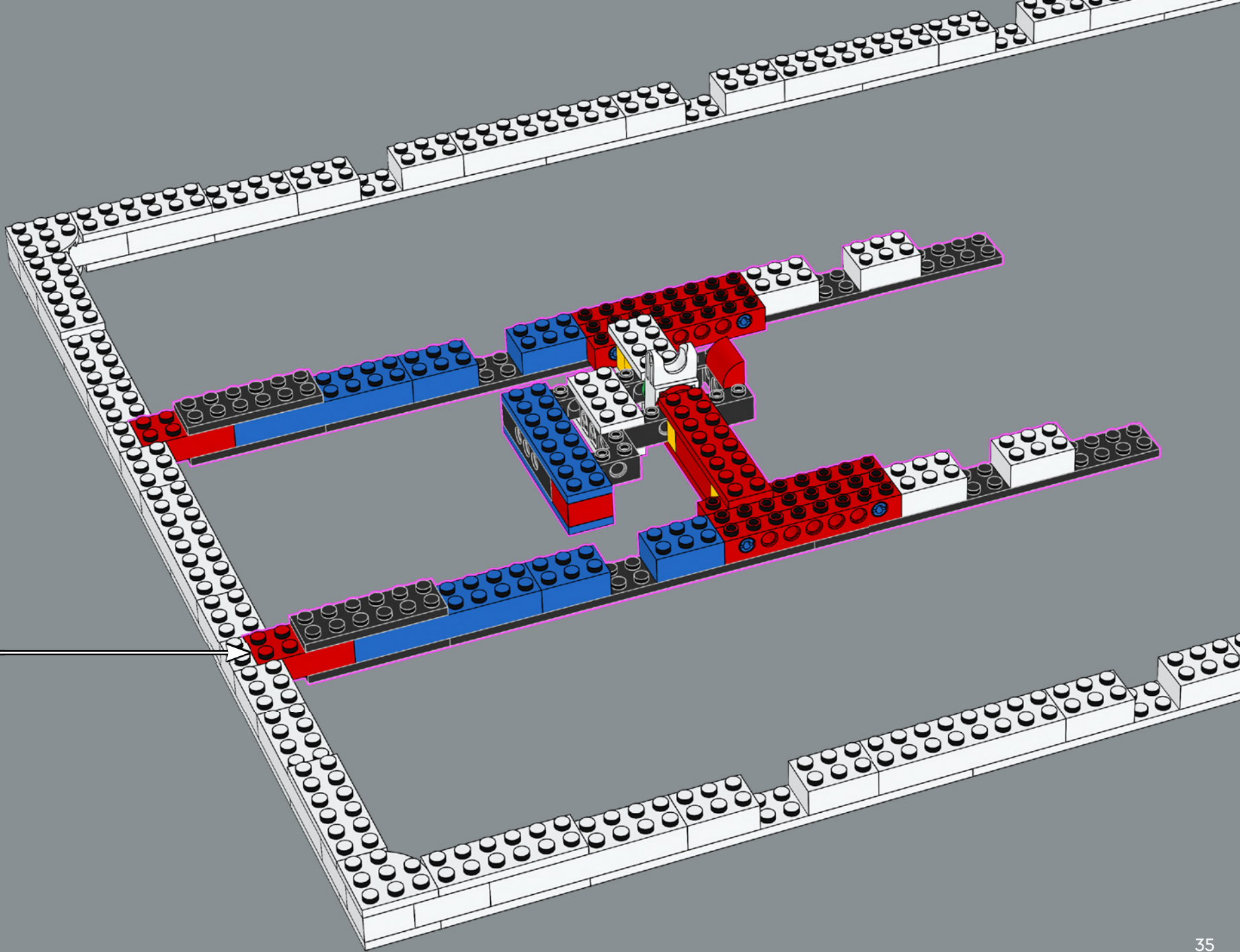

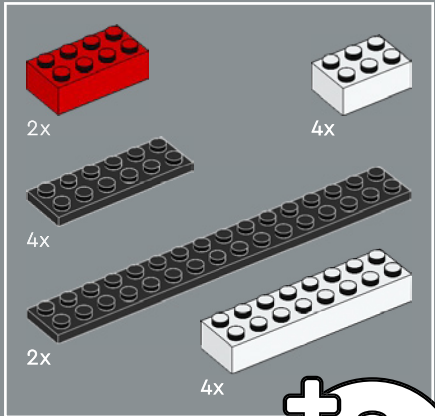
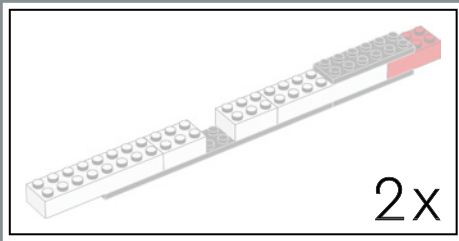

26

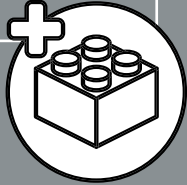

1

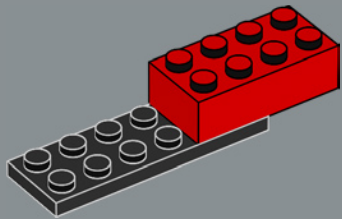

2

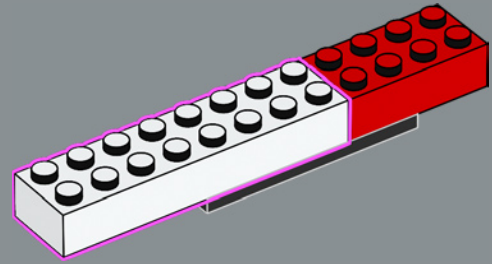

3

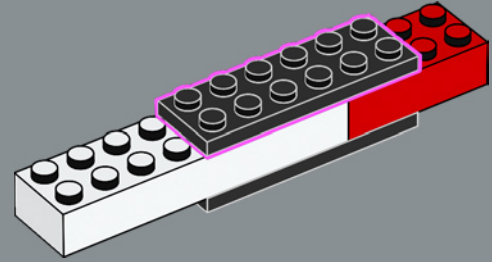

4

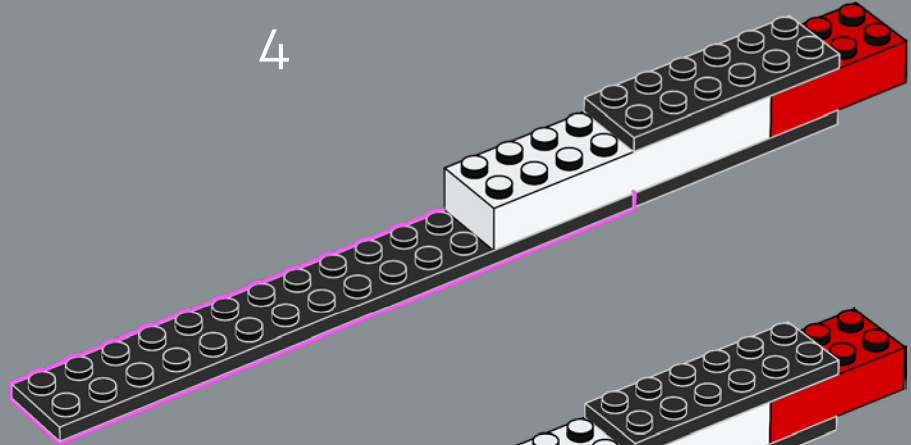

5

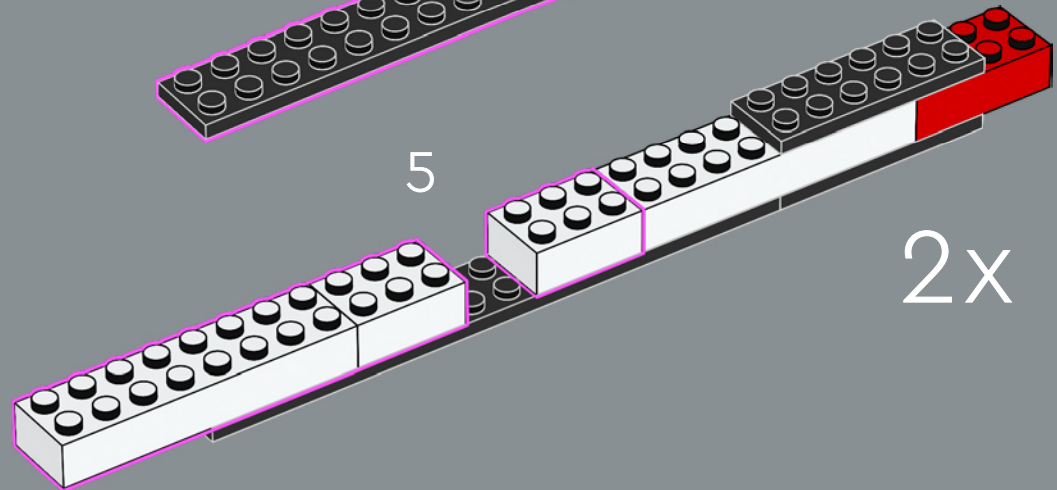

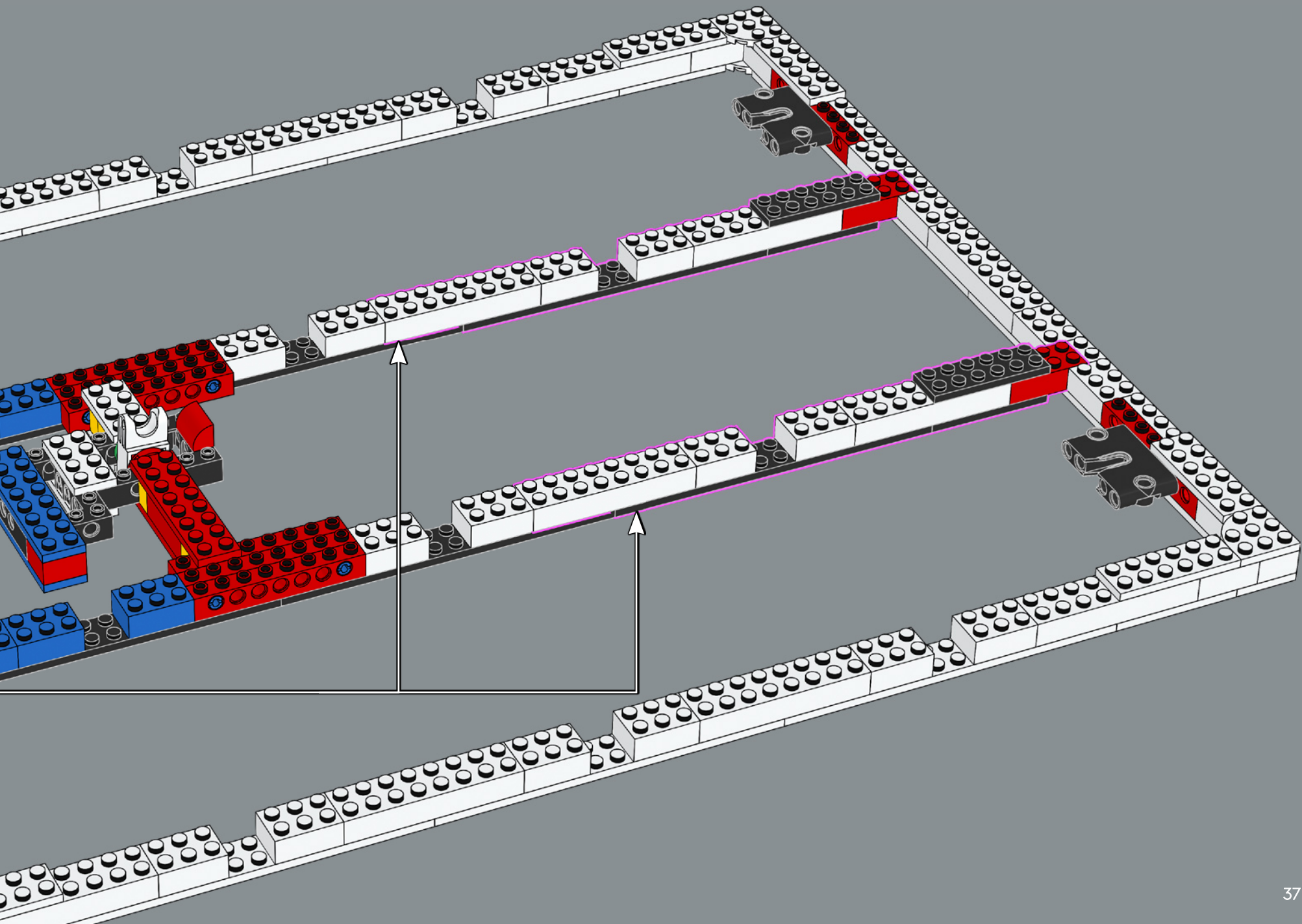

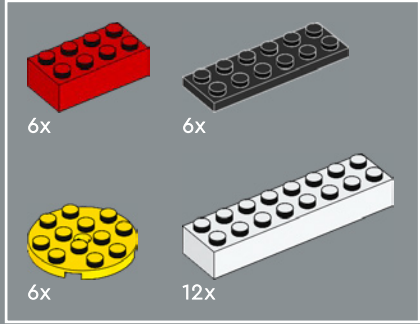
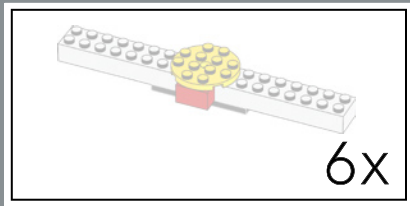

27

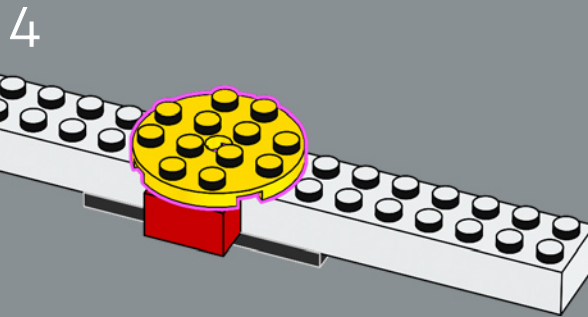
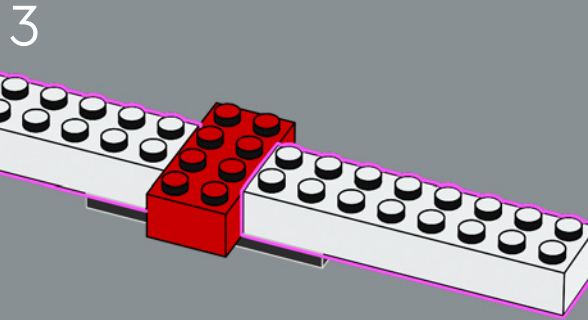
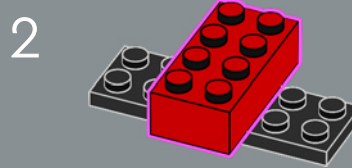
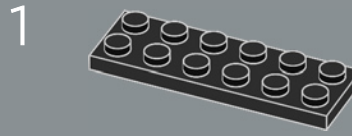

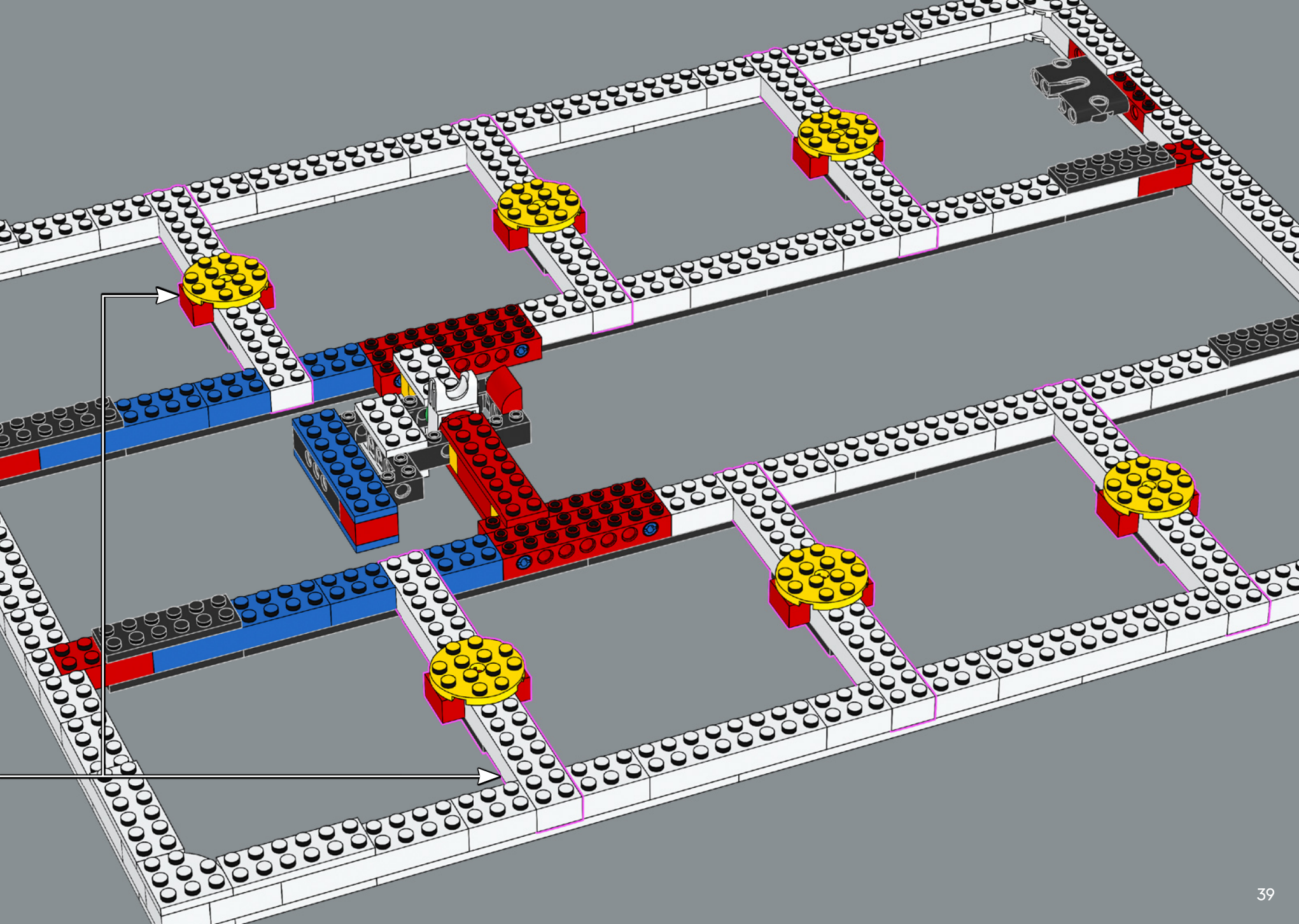

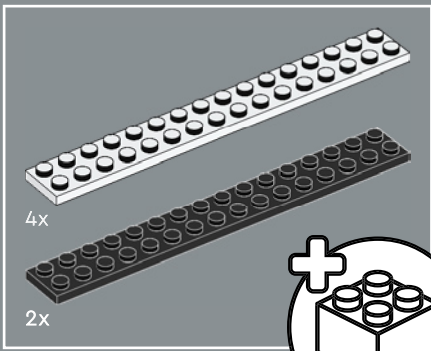

28

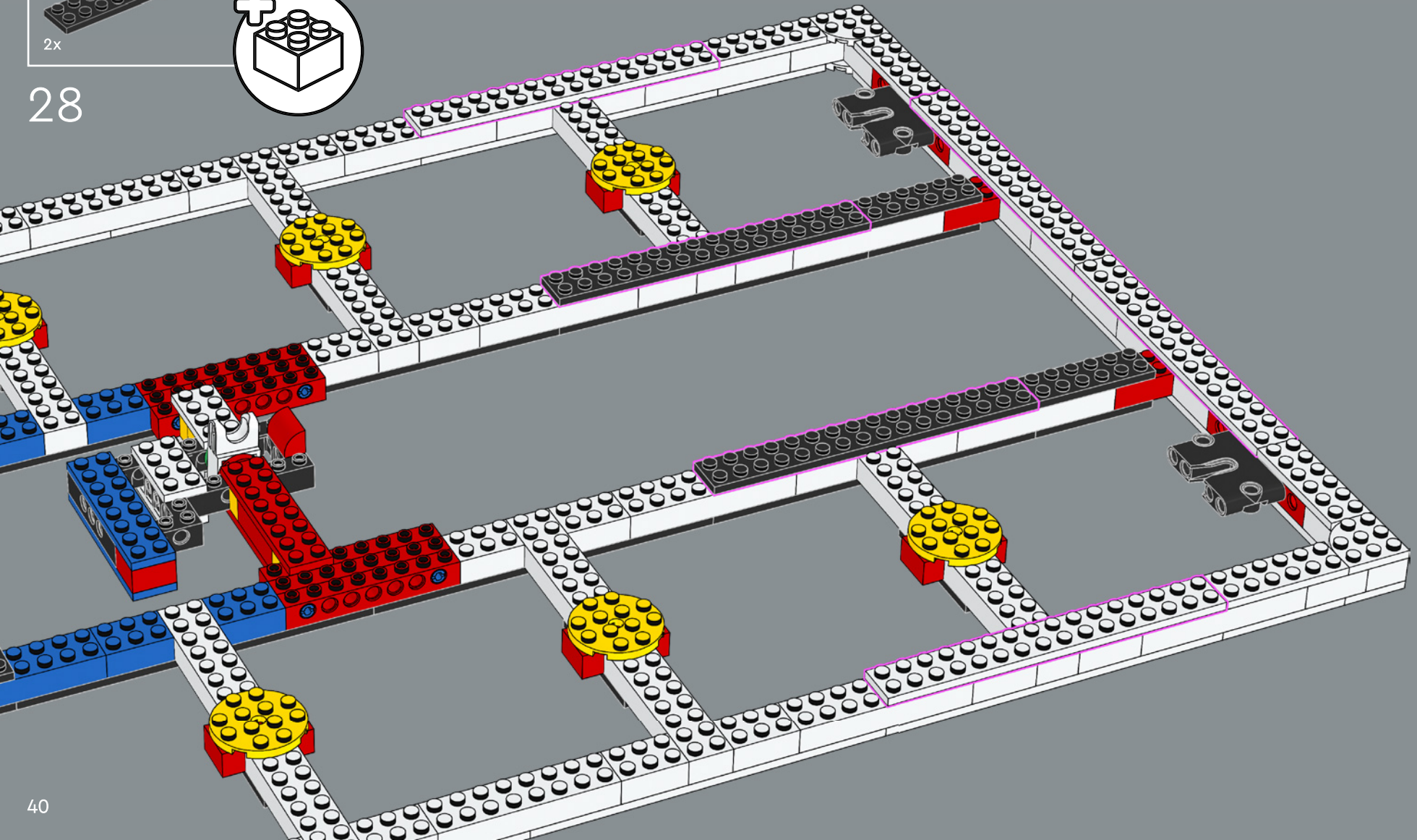

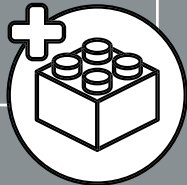
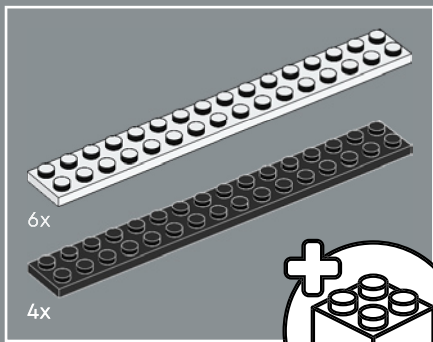

The colours used in this model were chosen to mimic the limited colours of both printed comics and LEGO® elements in the 1960s!

29

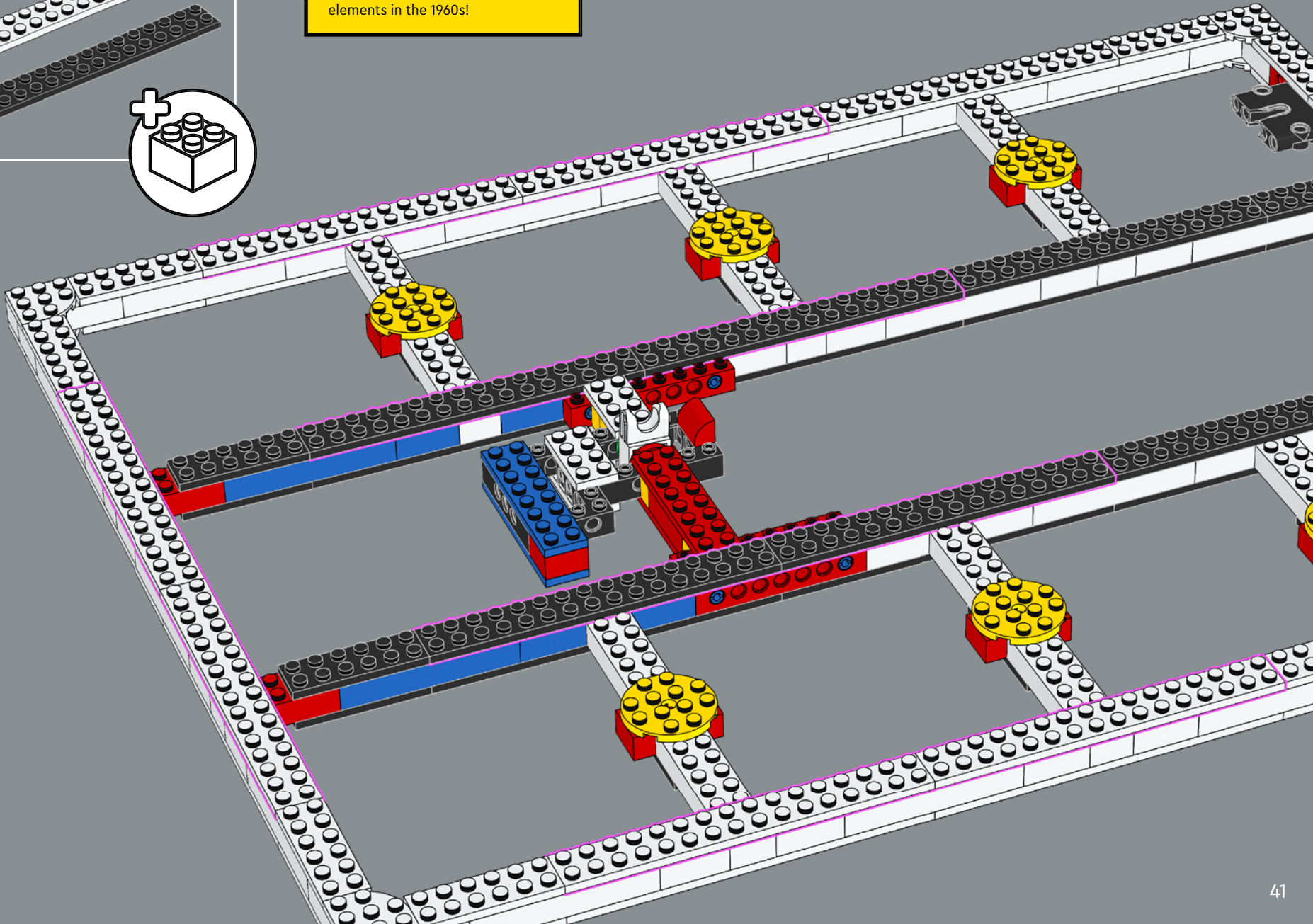



30

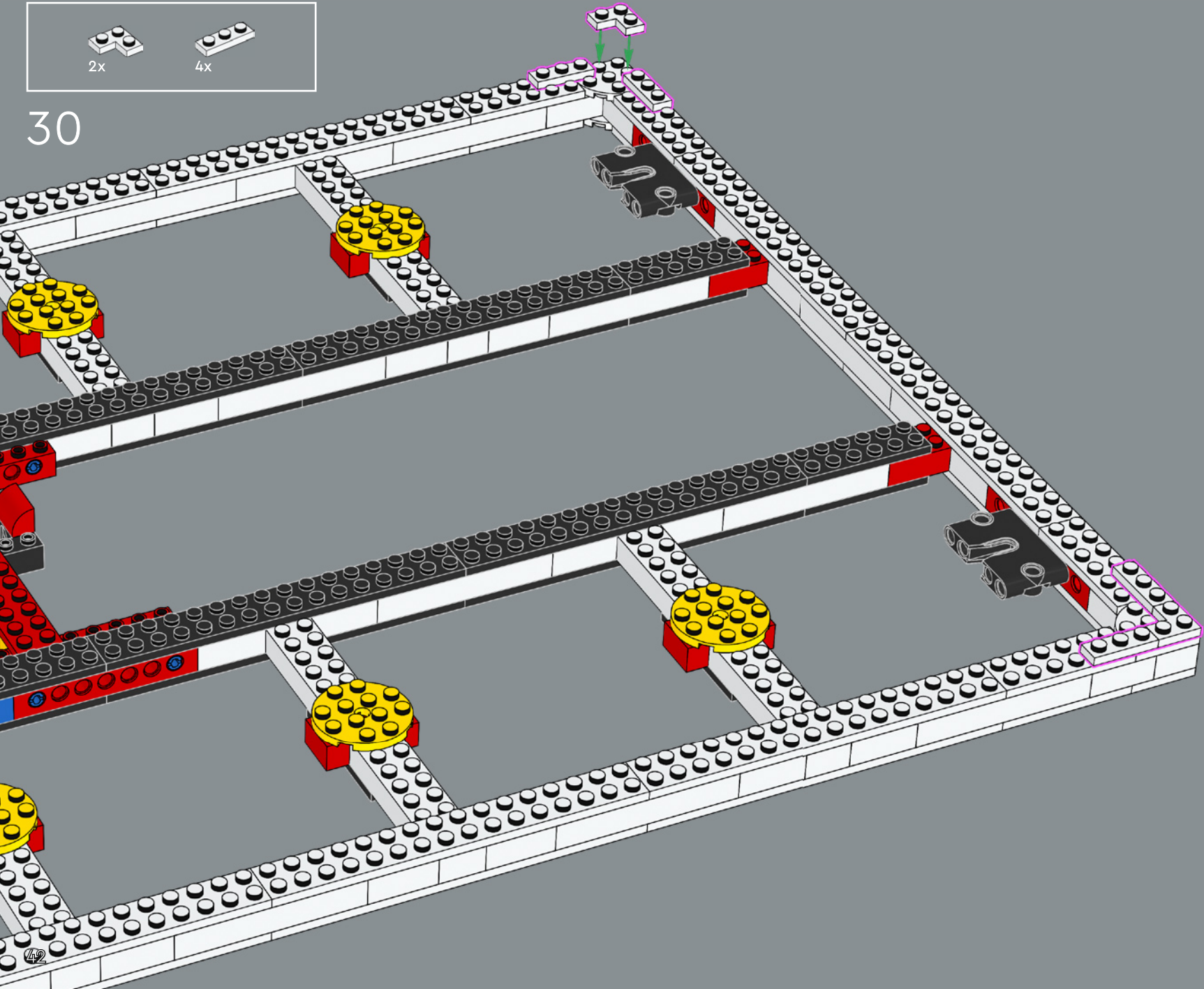

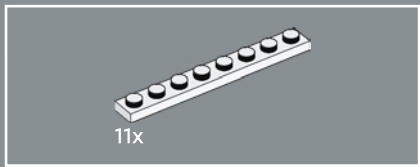

31

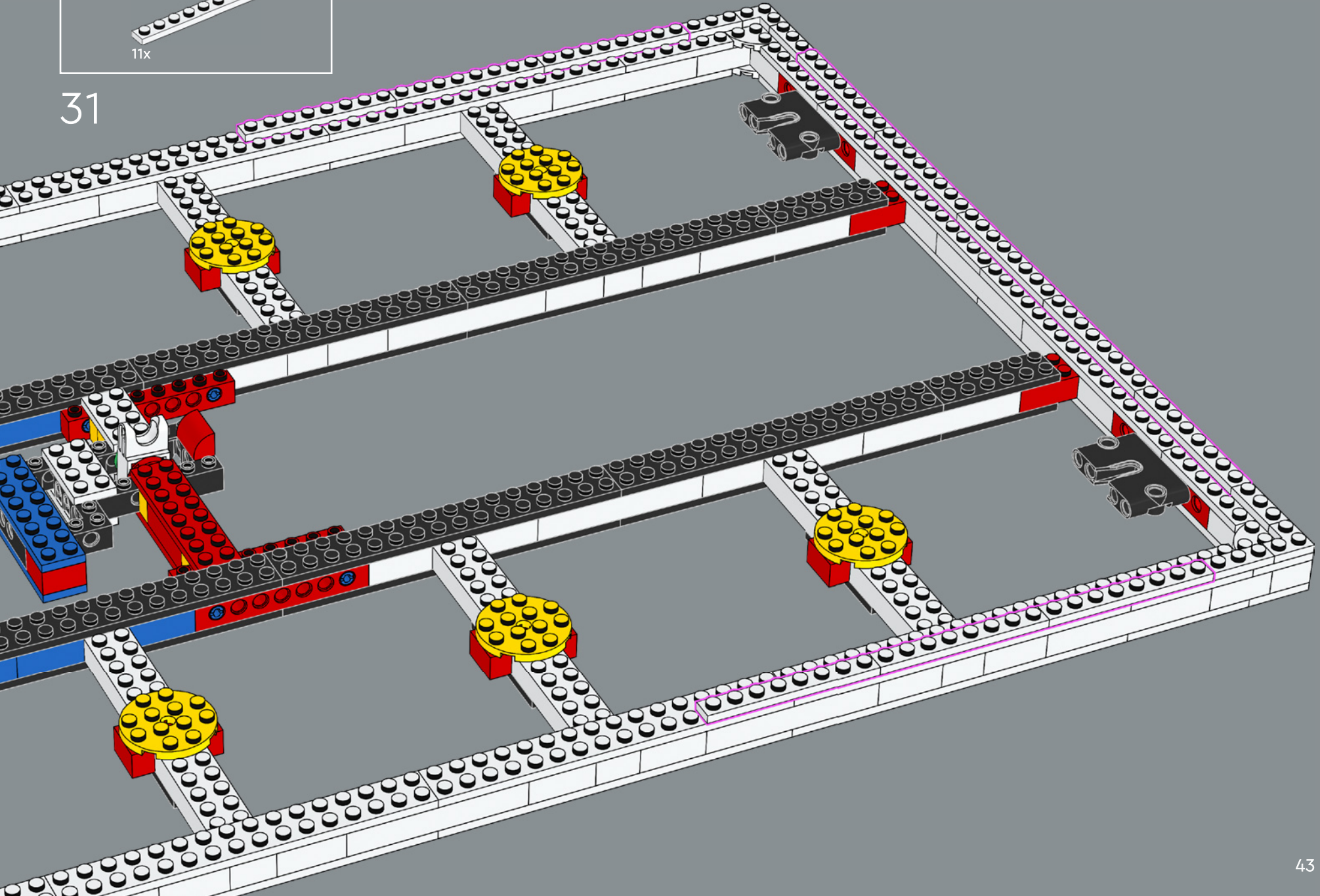

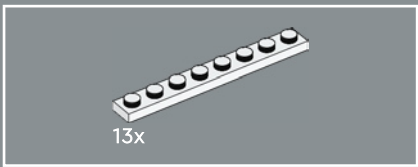

33

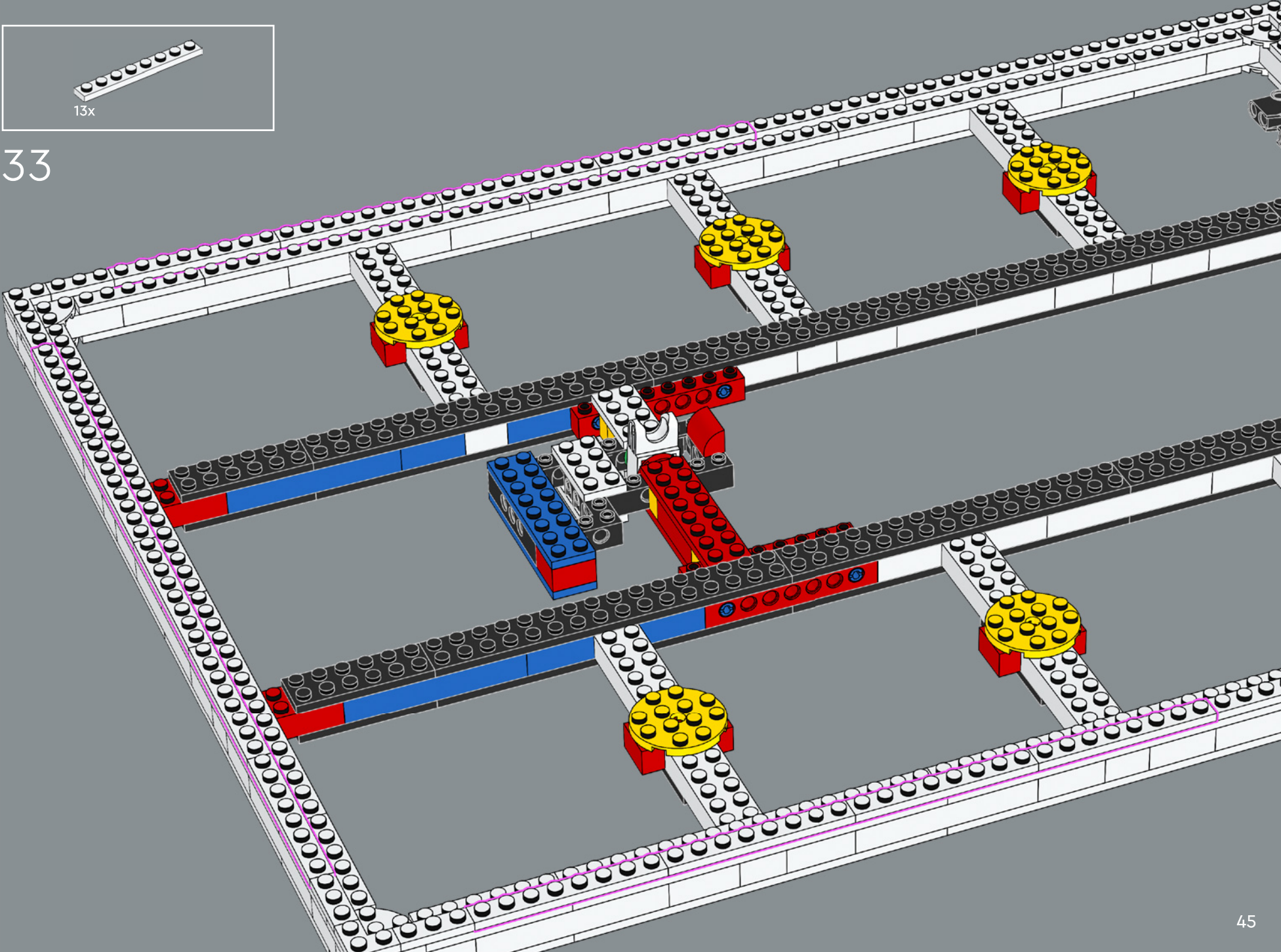

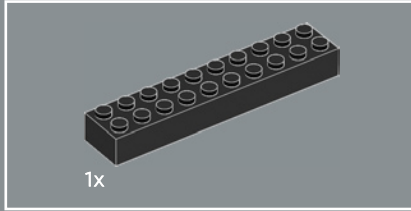
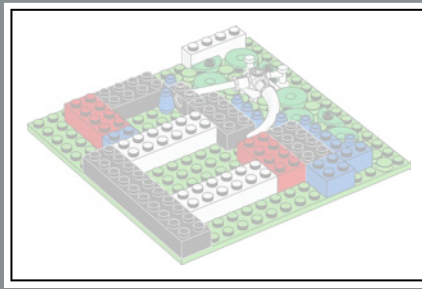
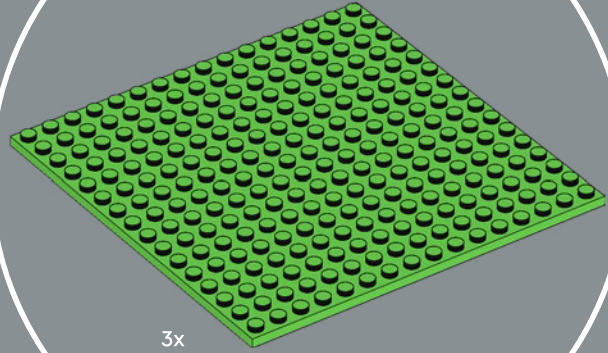
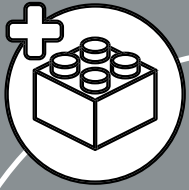

34

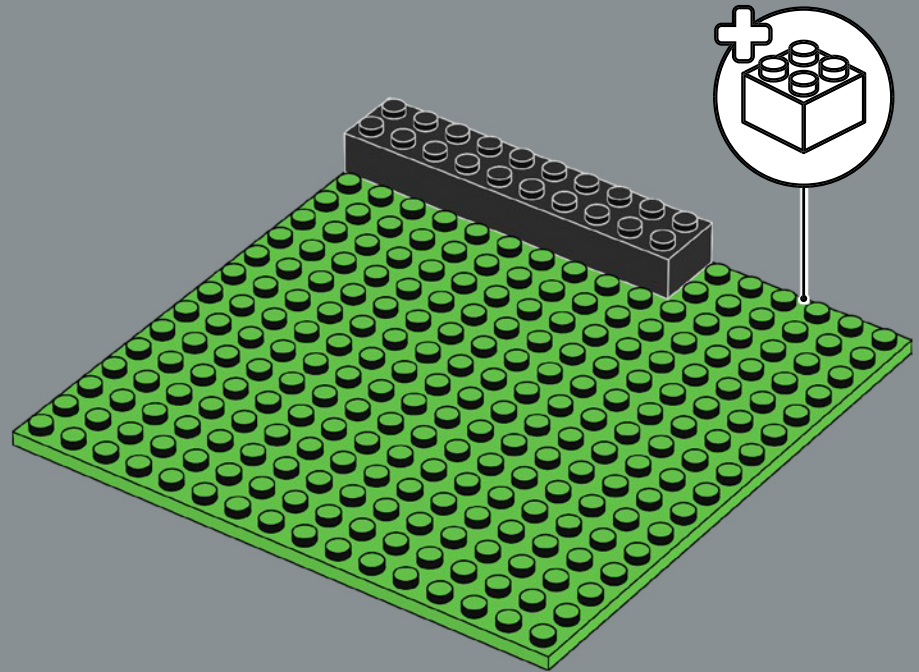

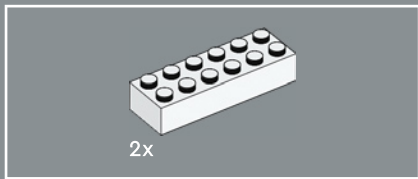

35

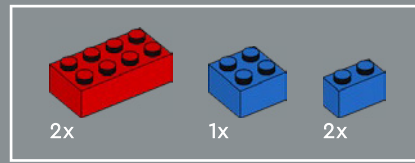
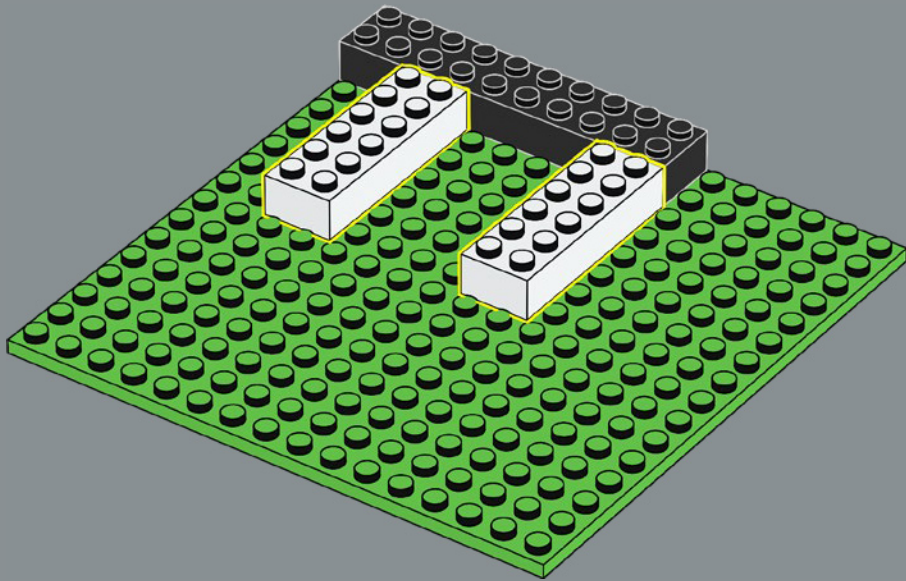

36

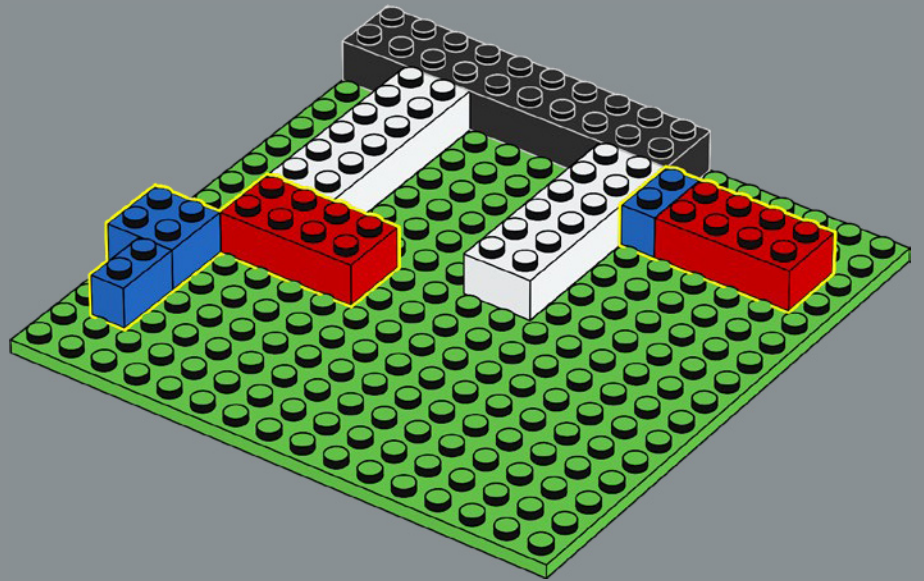

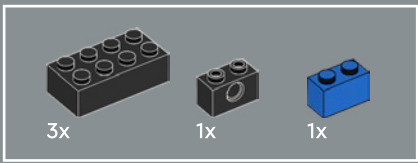

37

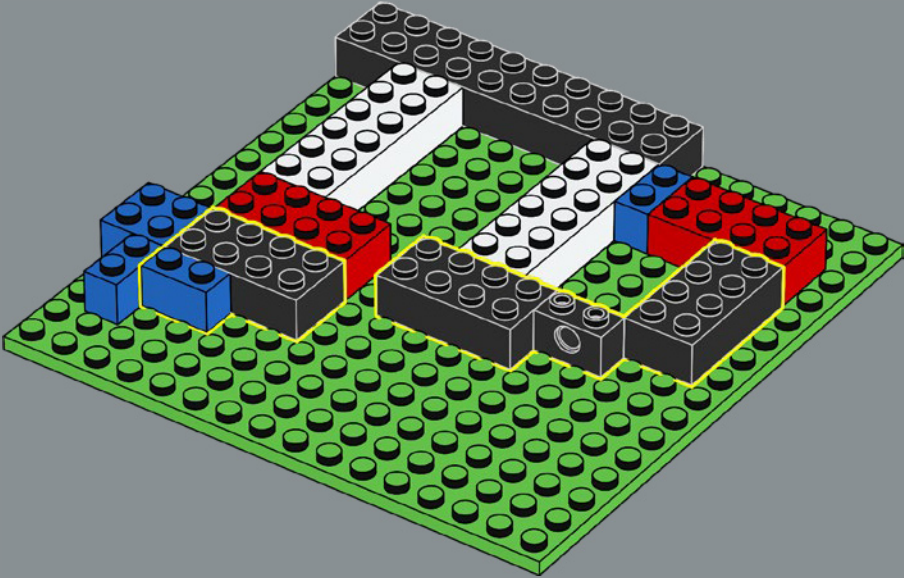

38

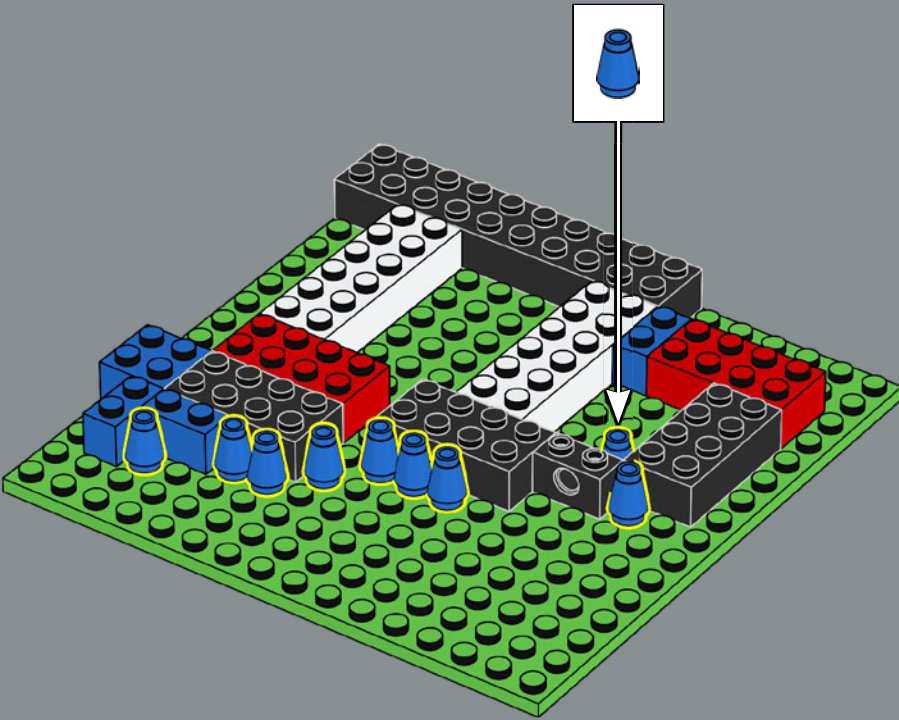



41

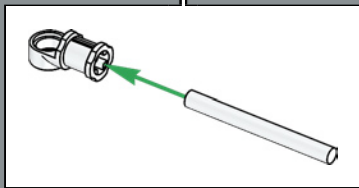
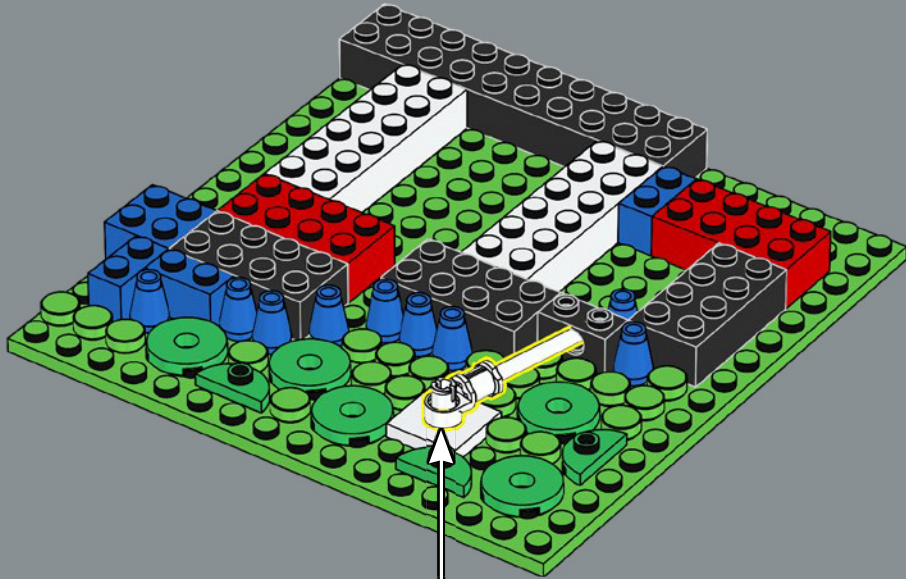

42

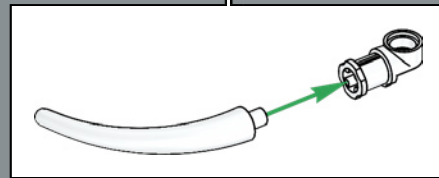
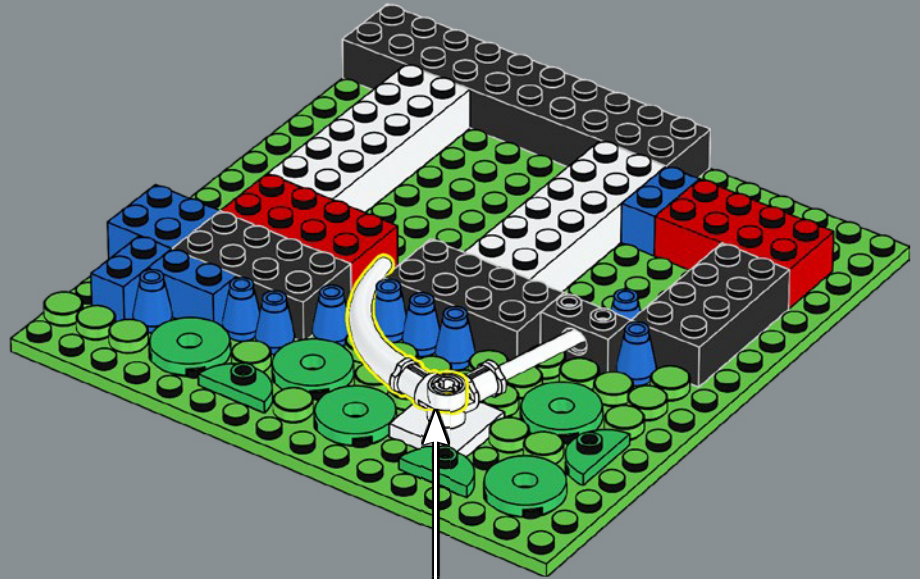



43

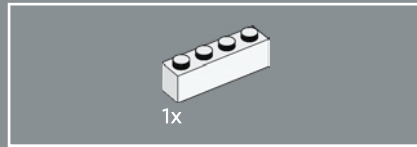
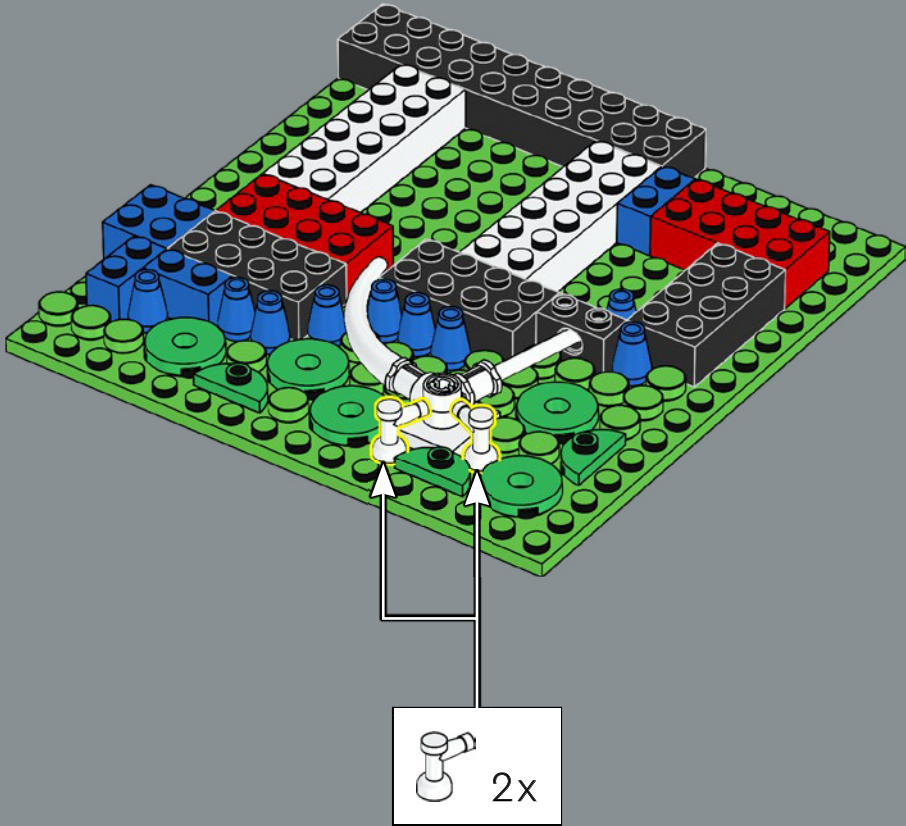

44

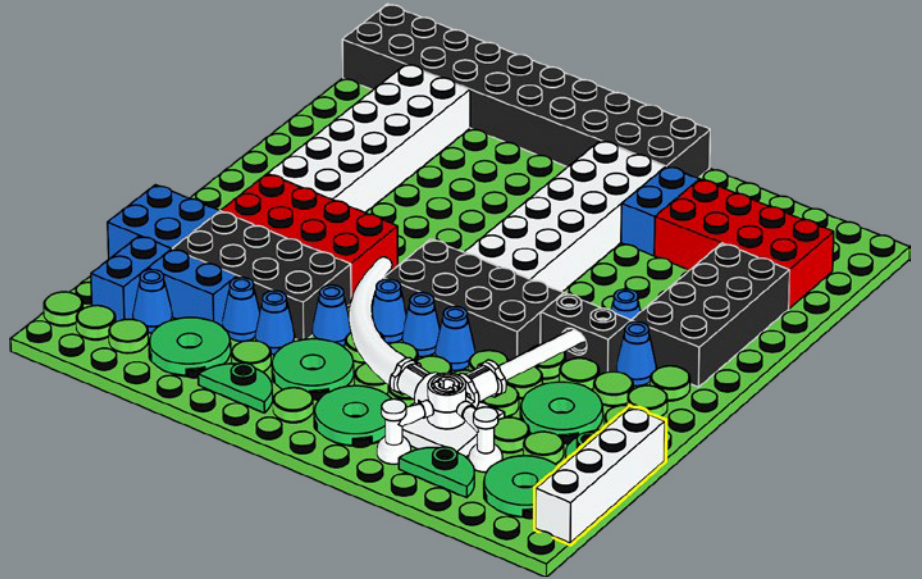

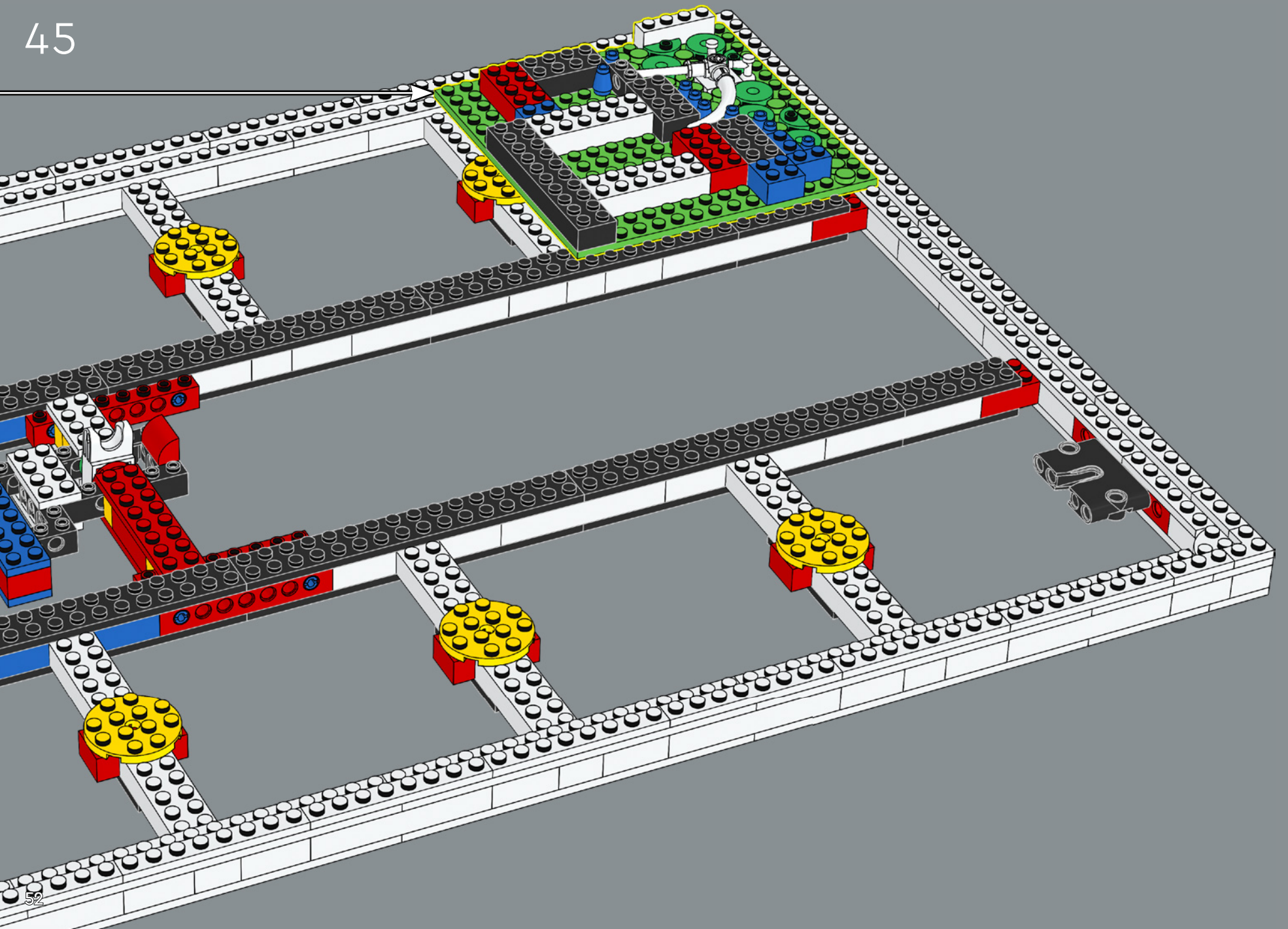

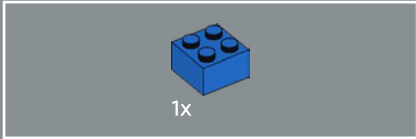
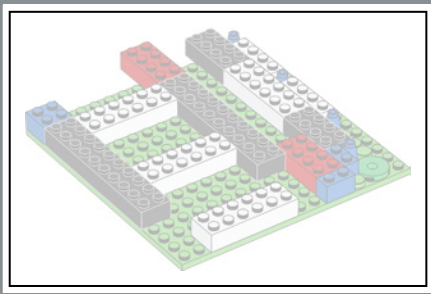

46

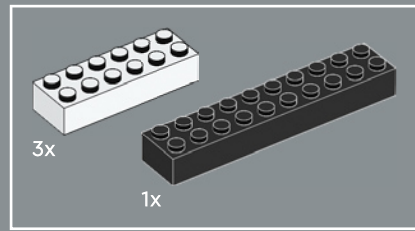
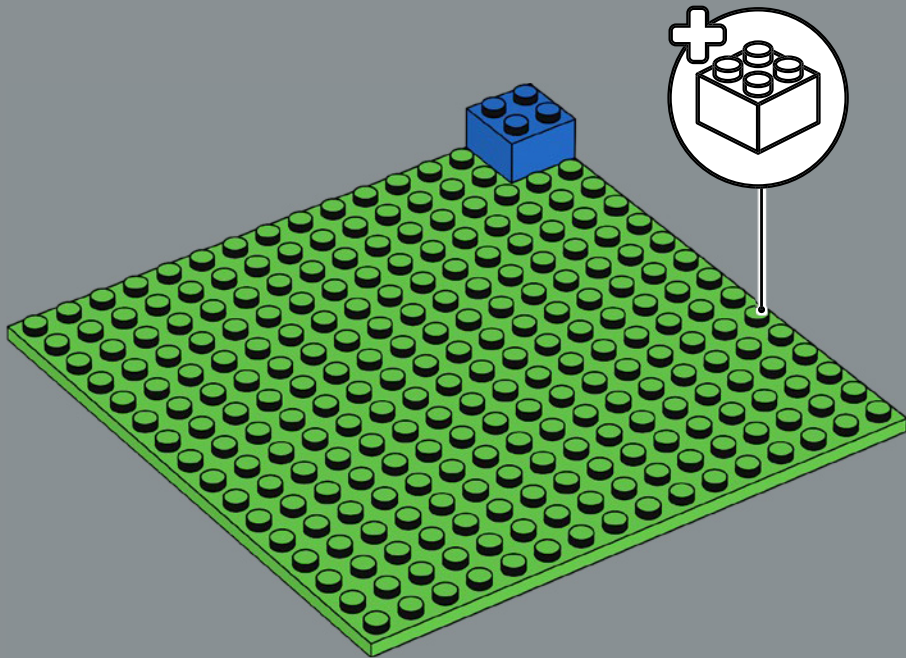

47

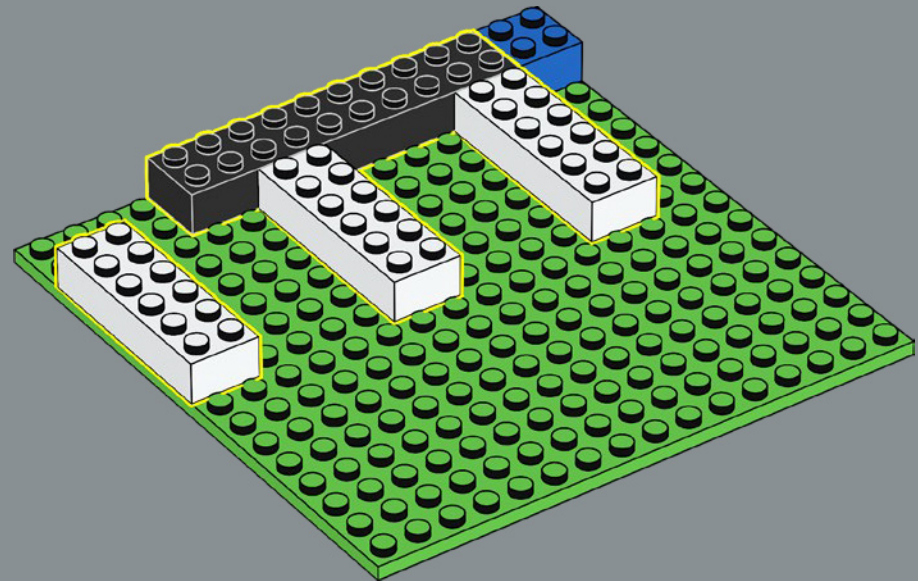

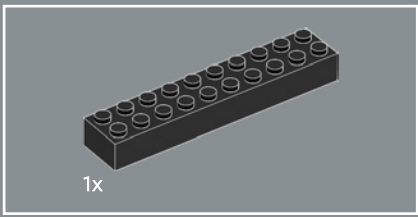

48

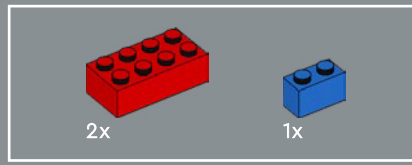
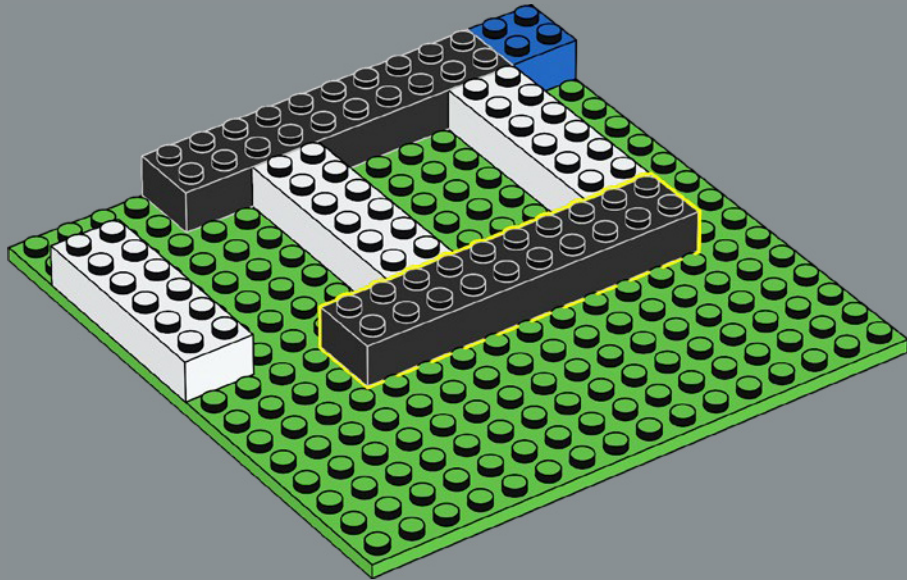

49

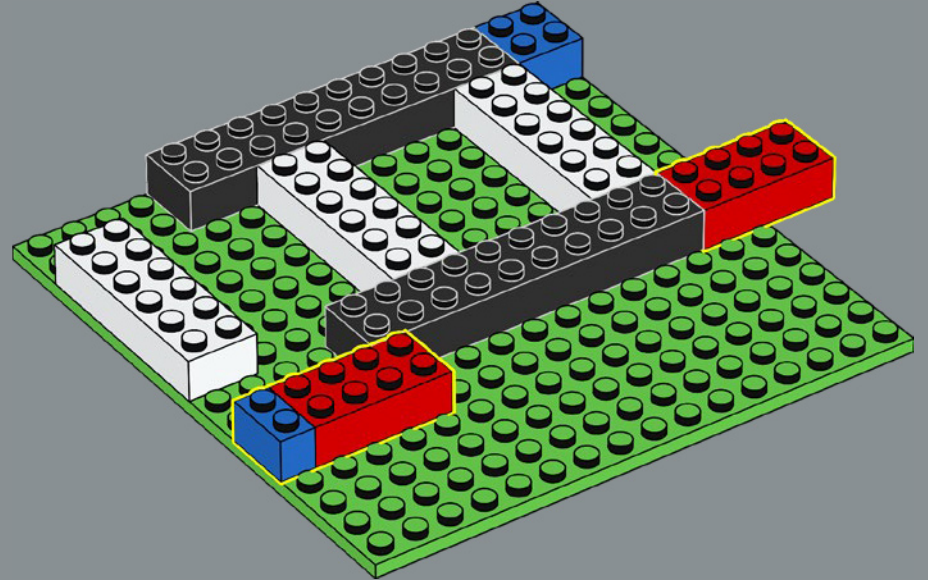

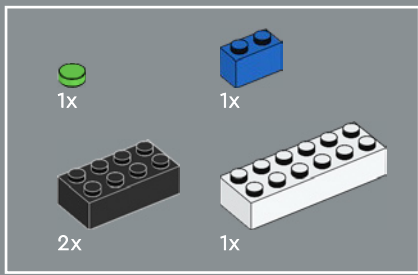

50

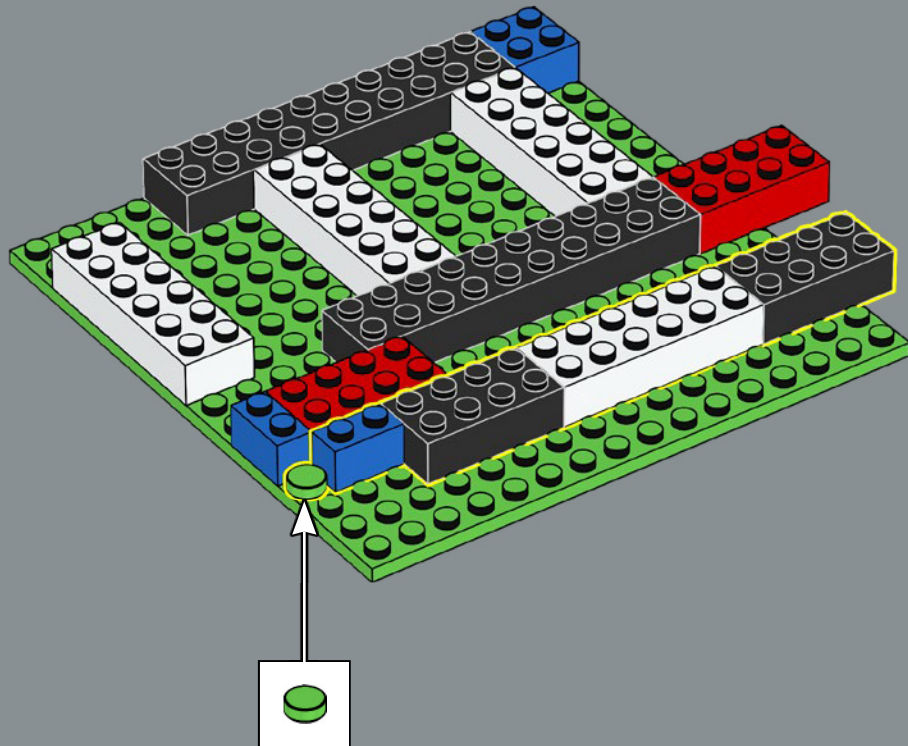

51

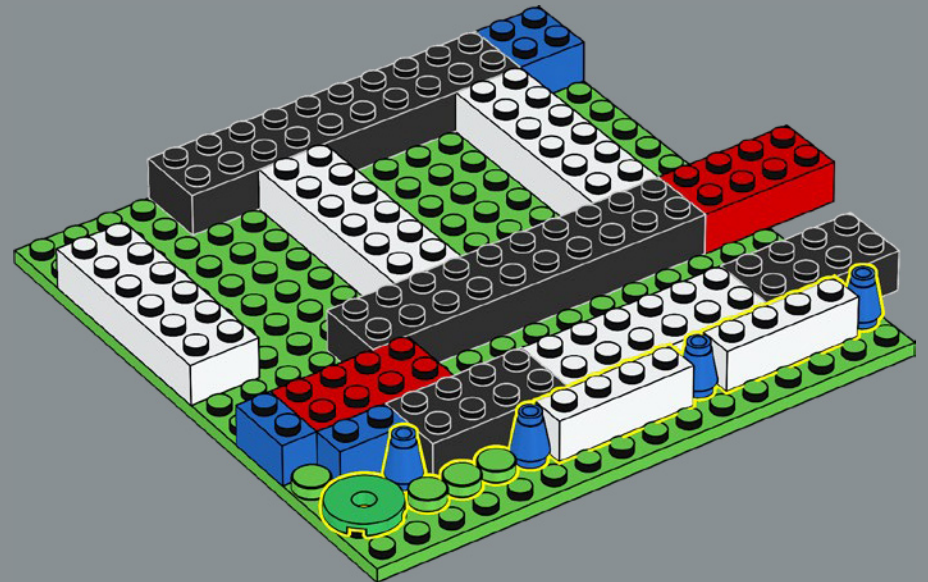

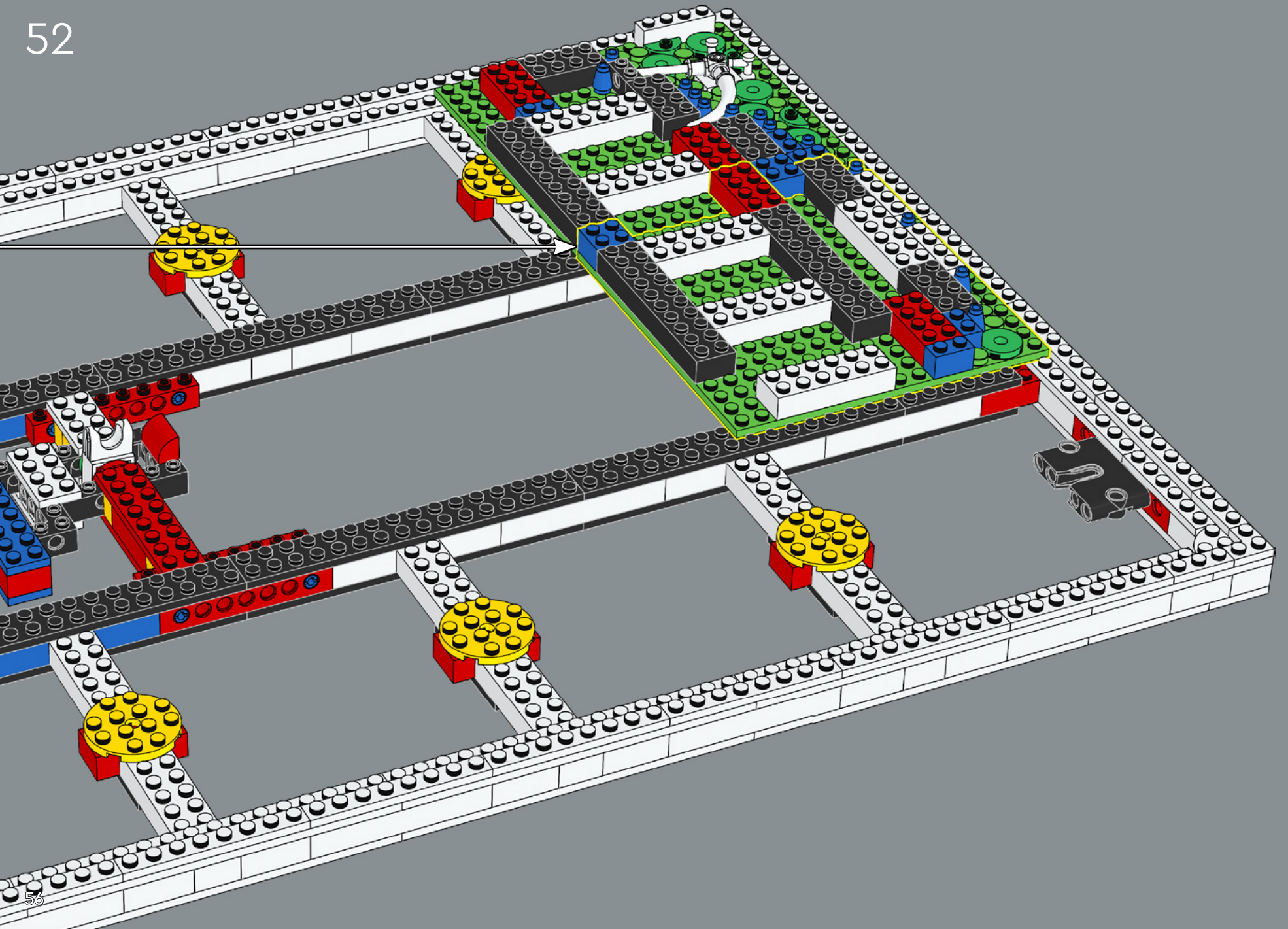

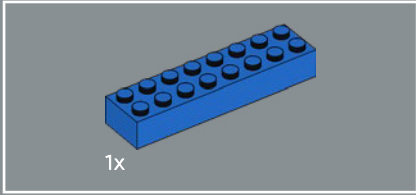
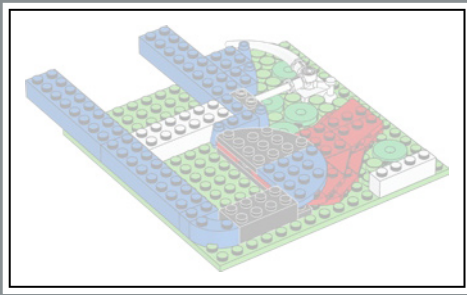

53

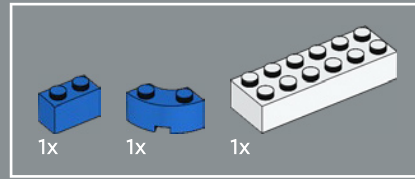
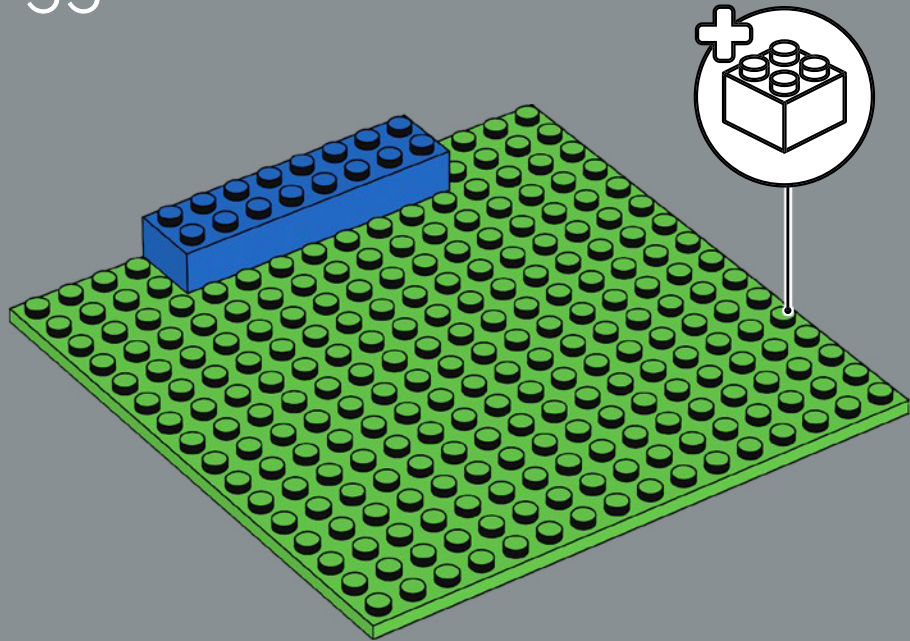

54

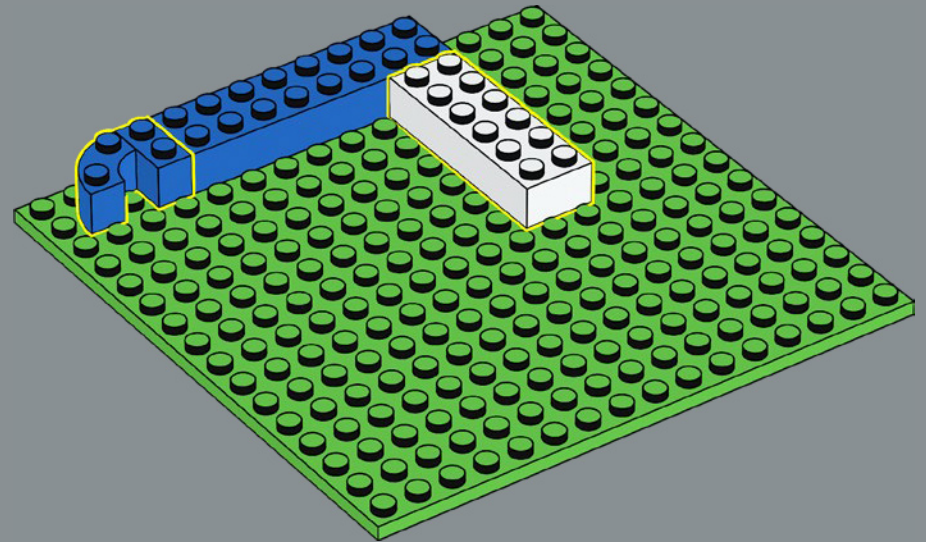

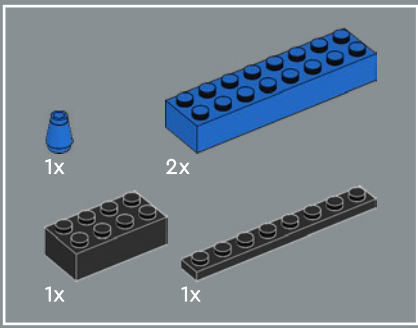

55

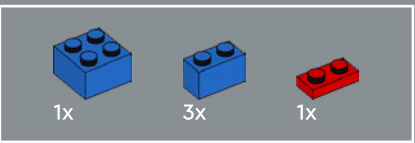
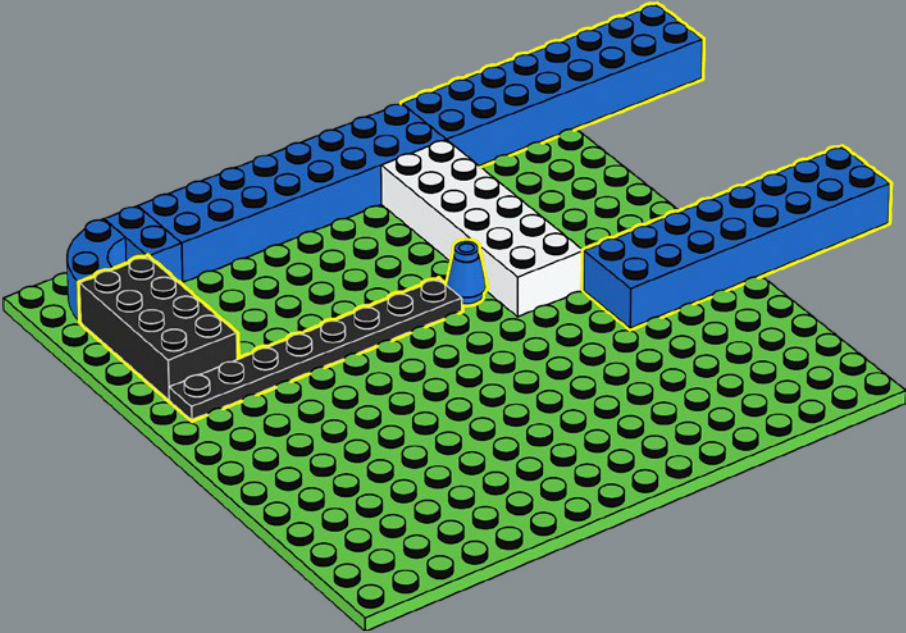

56

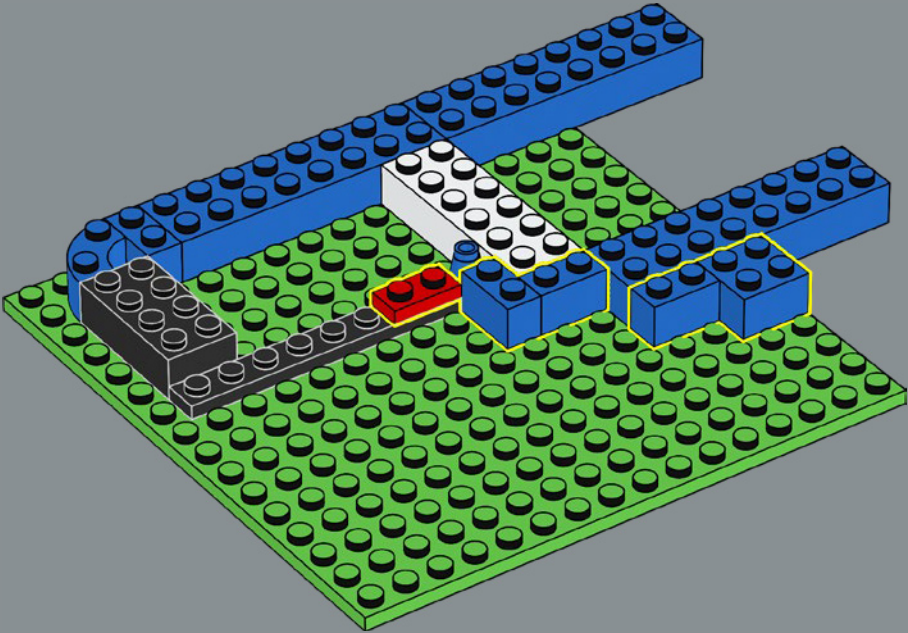

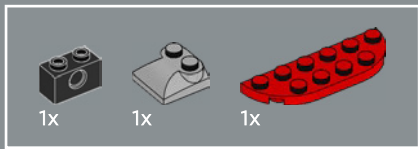

57

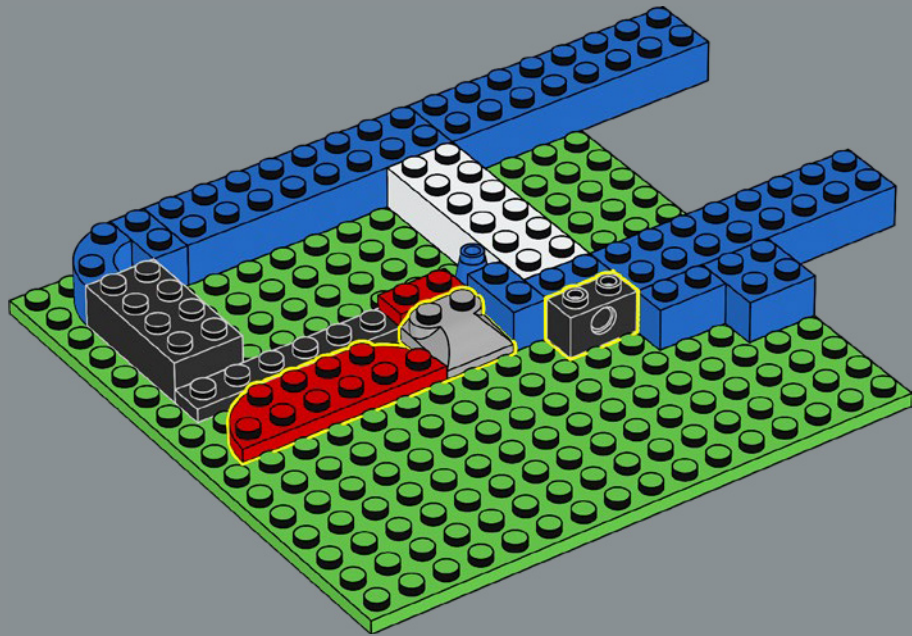

58

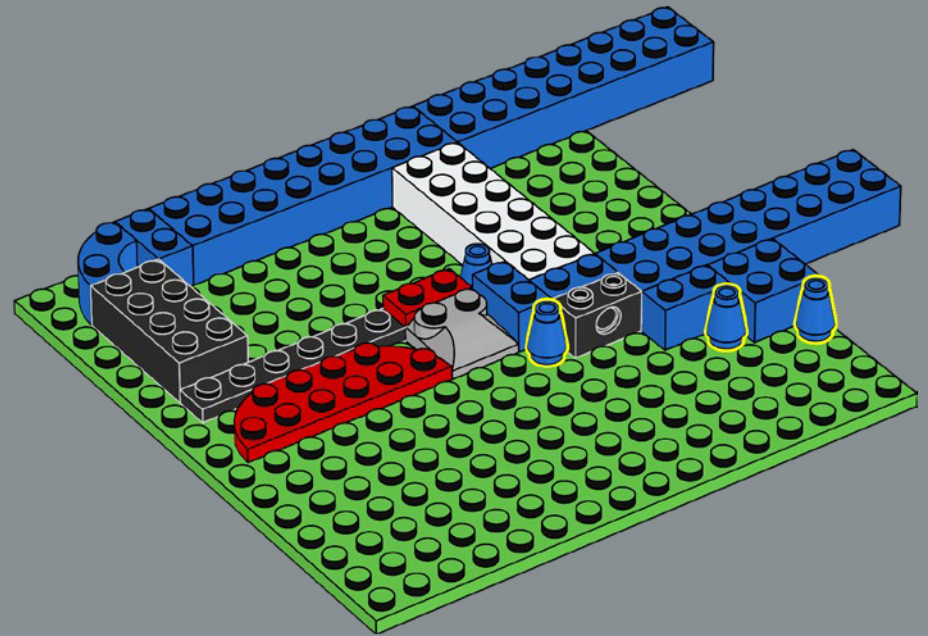

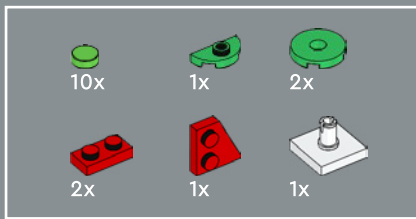

60

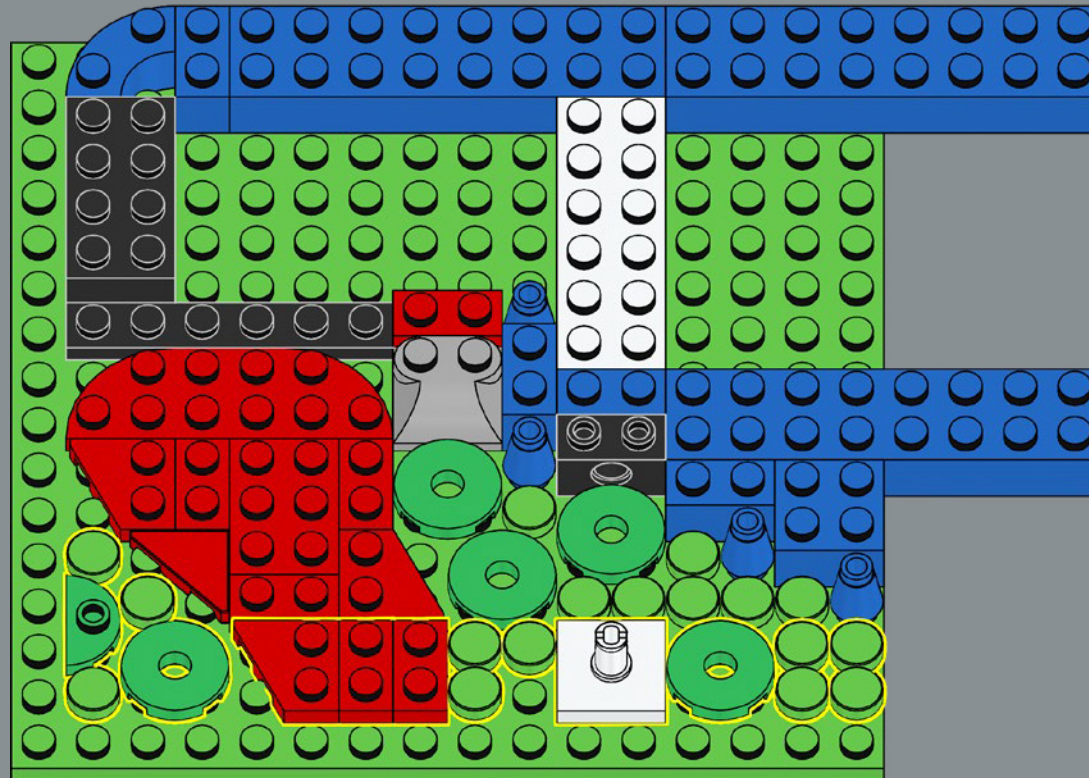

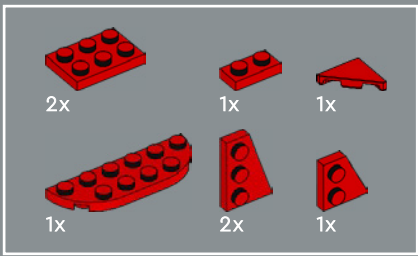

61

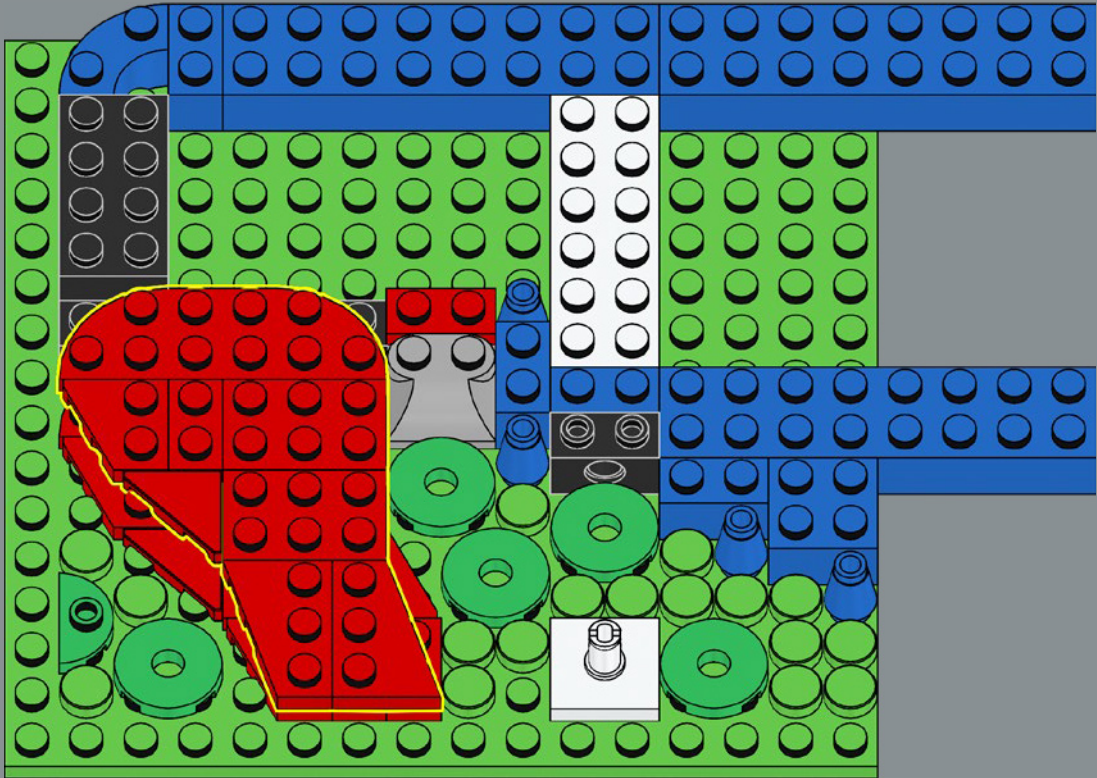

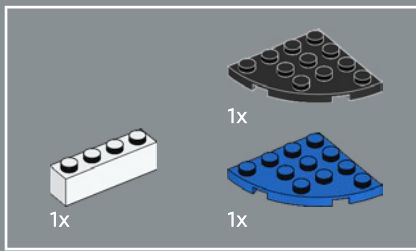

62

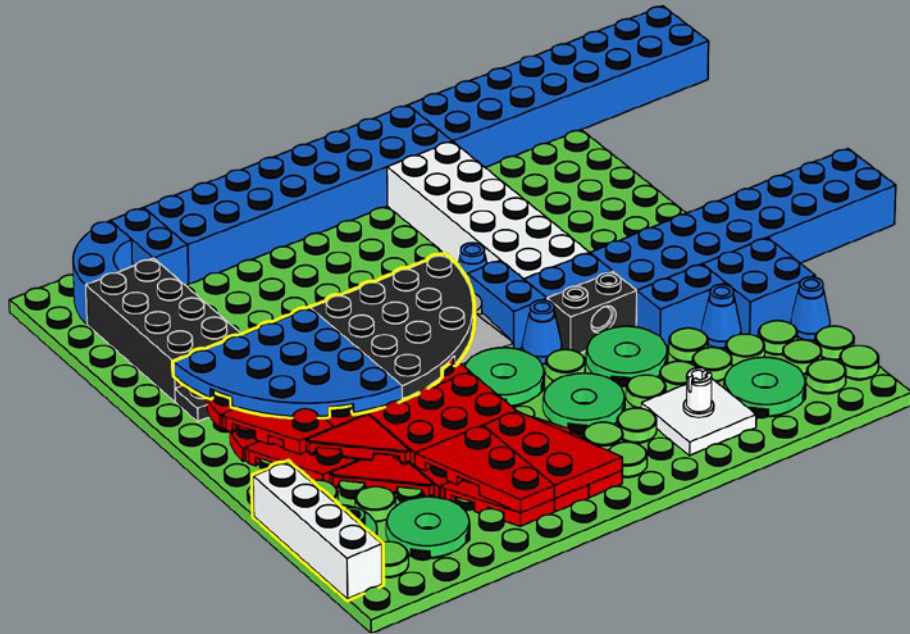

63

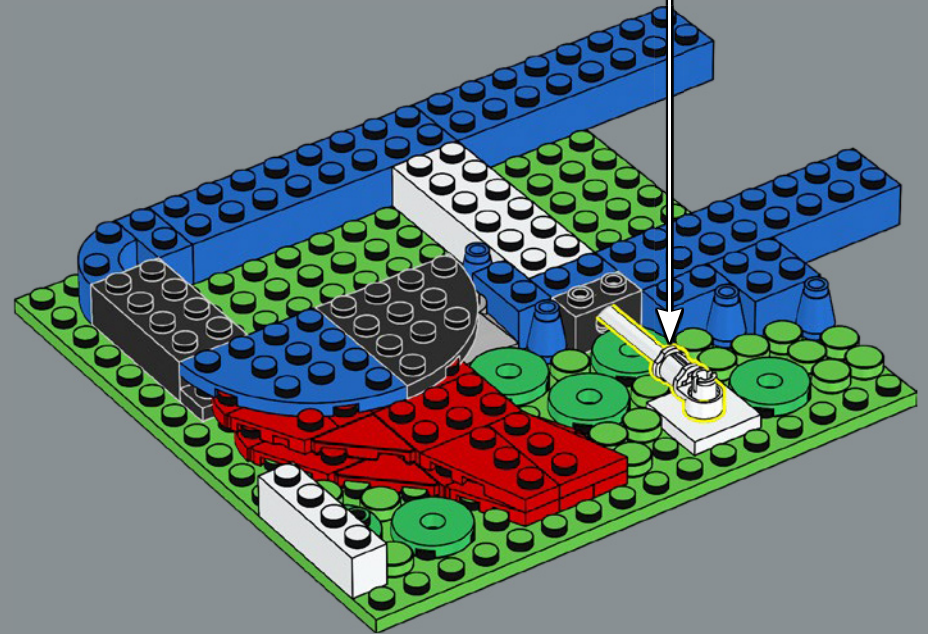
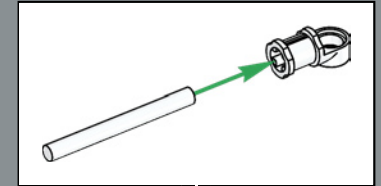



64

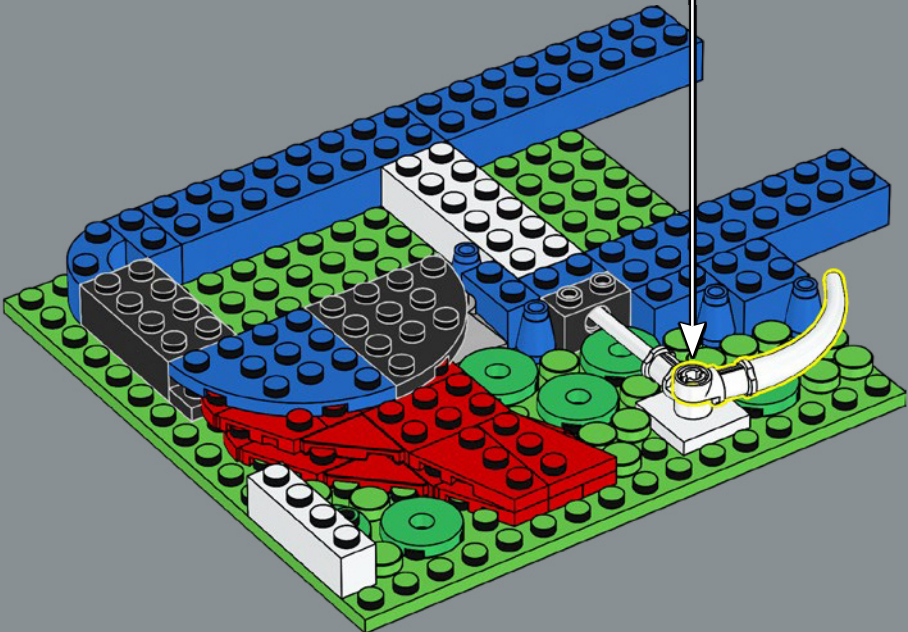
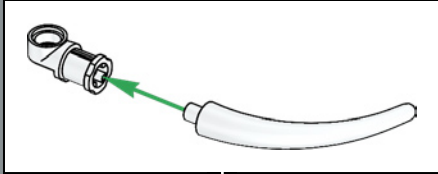

65

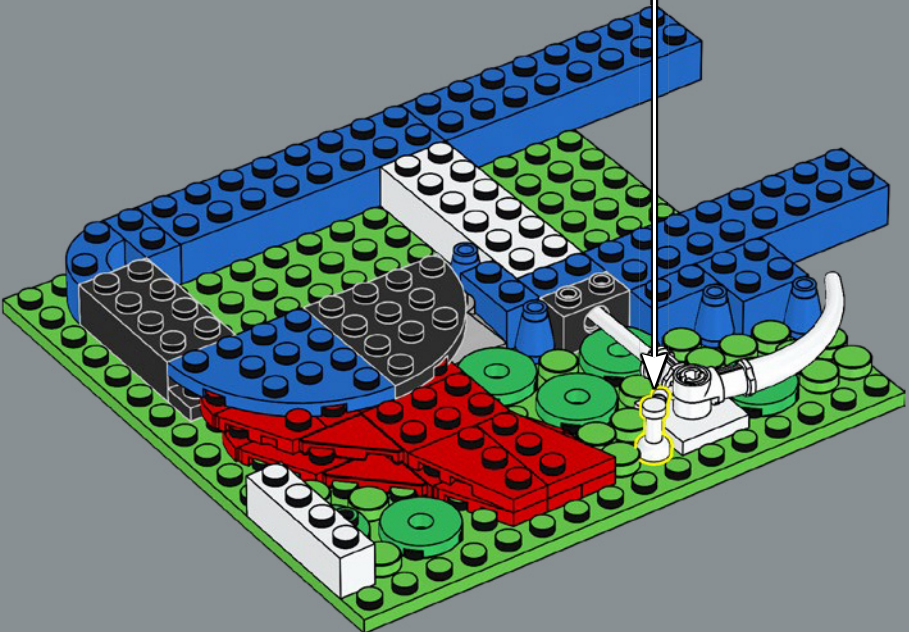

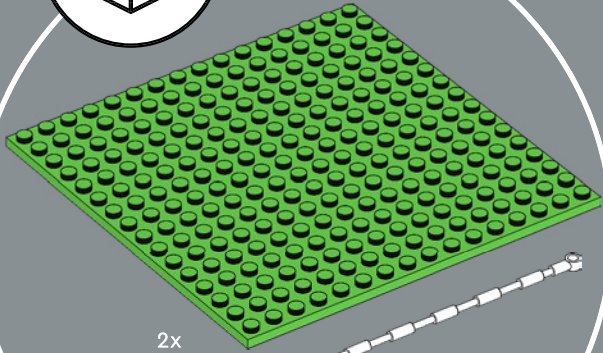
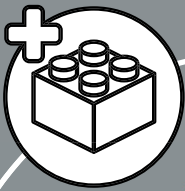

2x

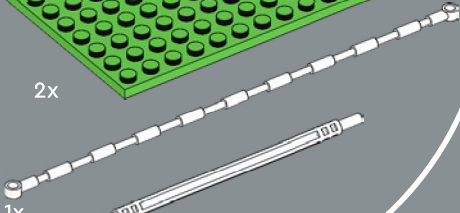

1x

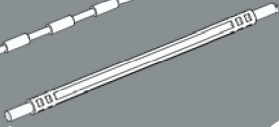

2x

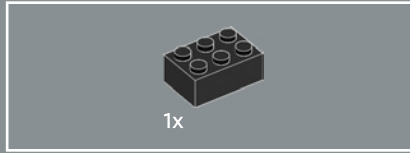
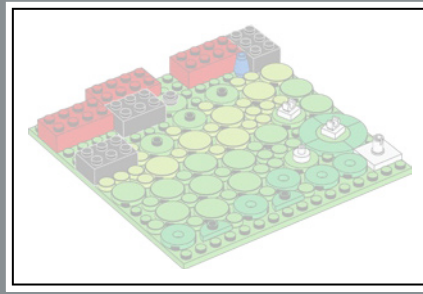

1x

67

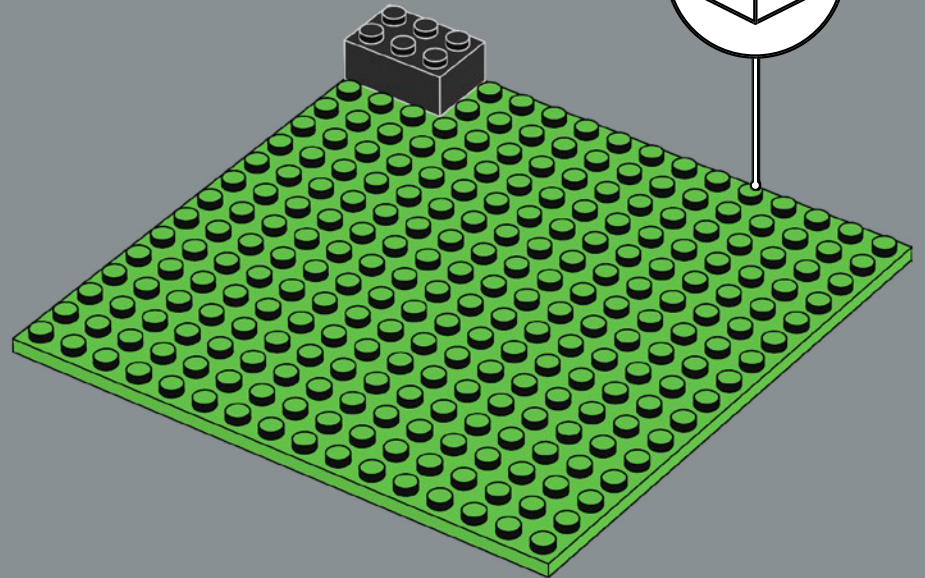
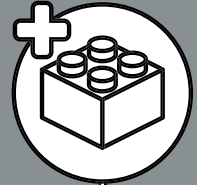

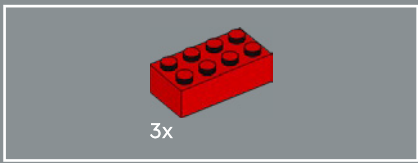

68

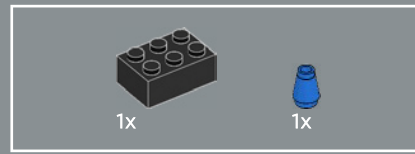
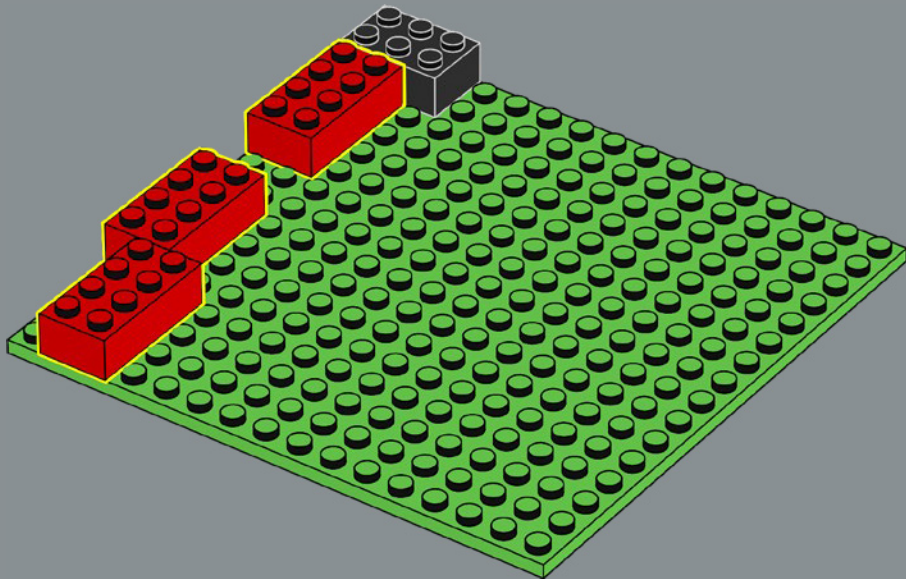

69

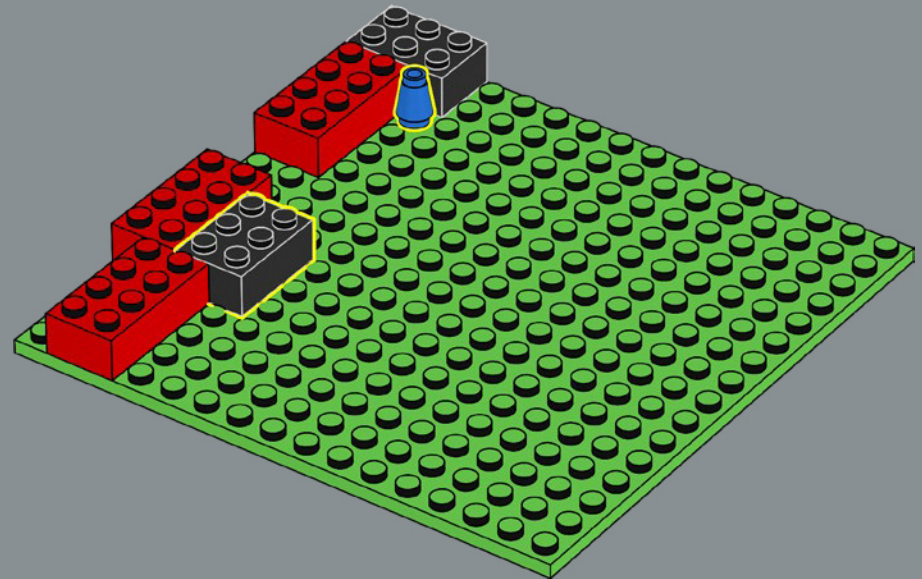



70

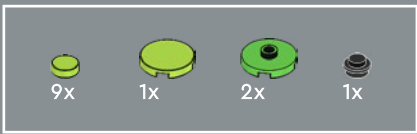
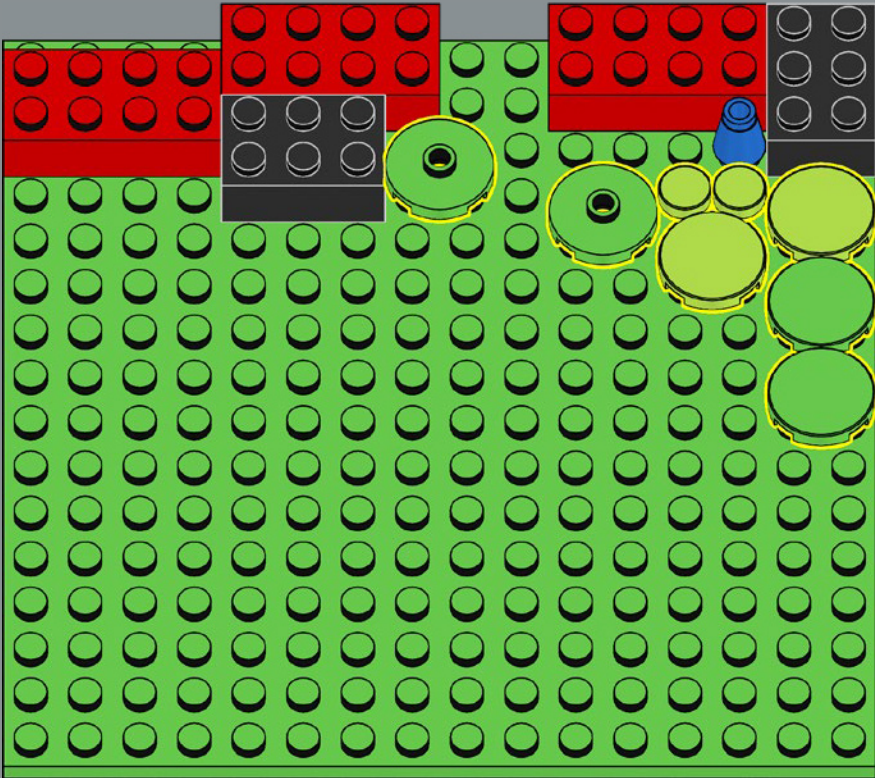

71

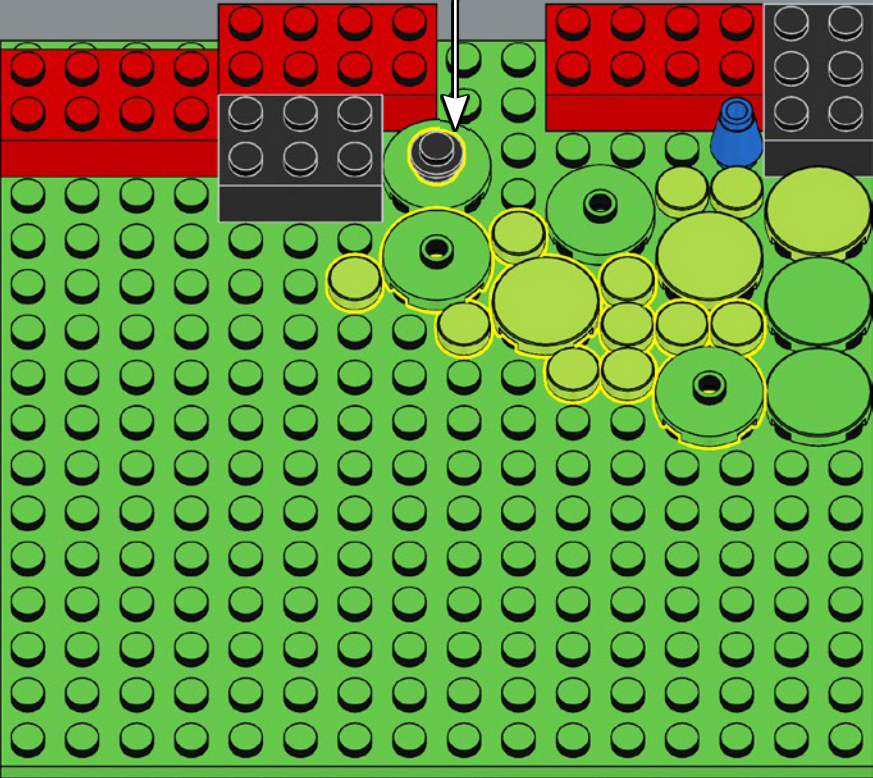

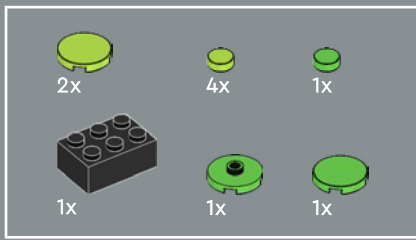

72

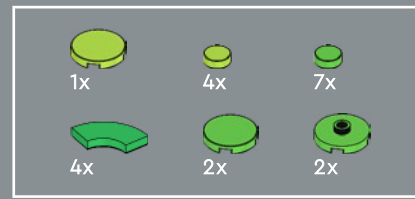
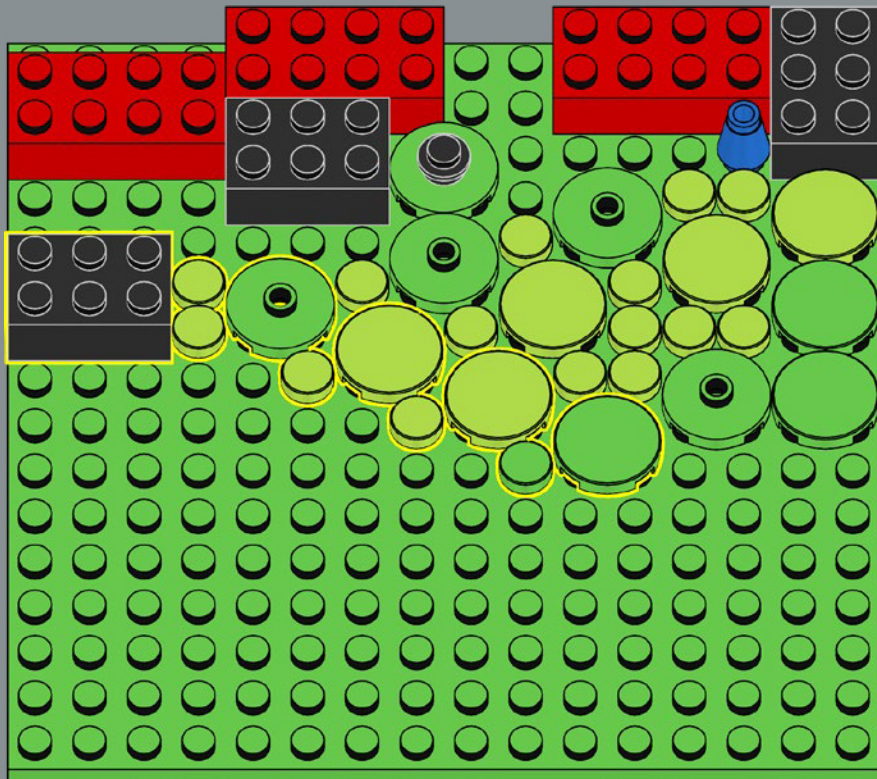

73

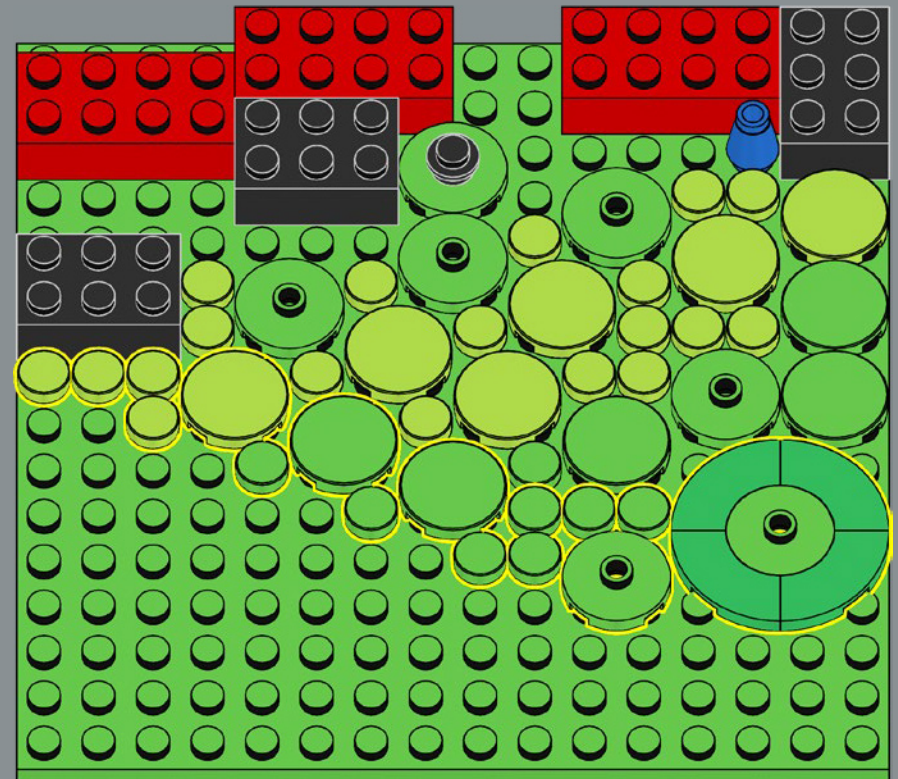

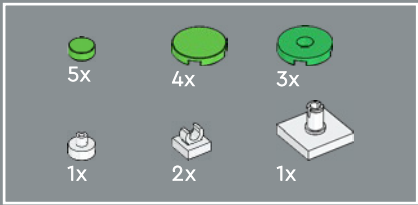

74

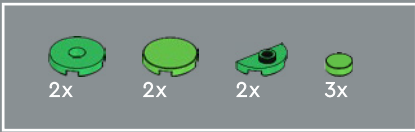
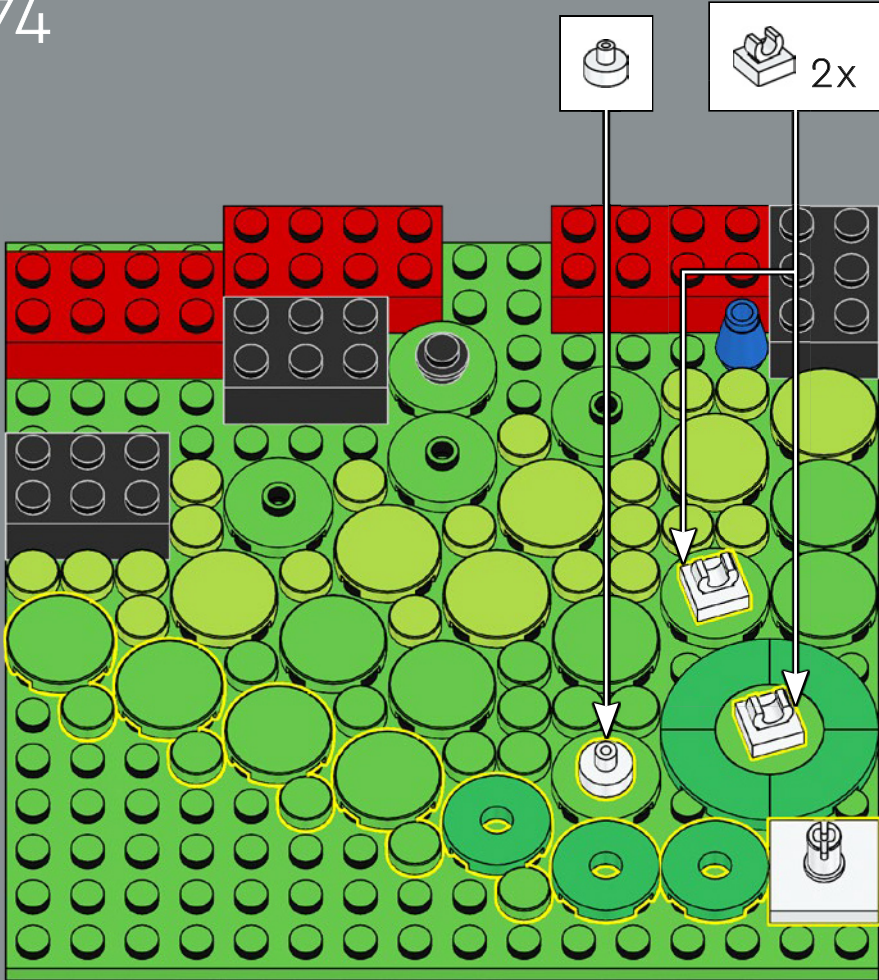

75

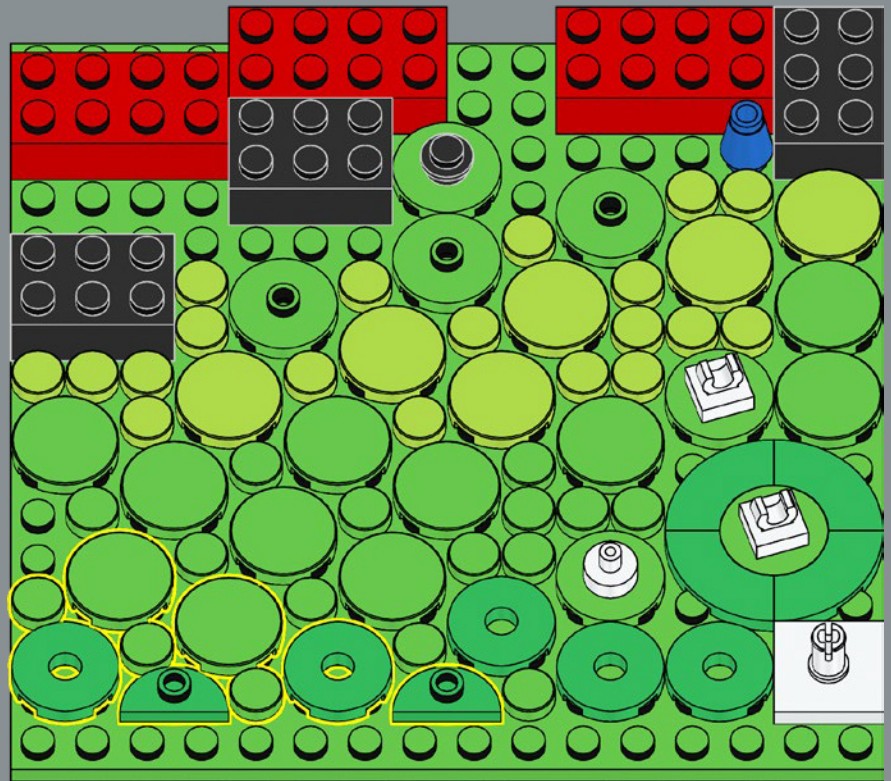

76

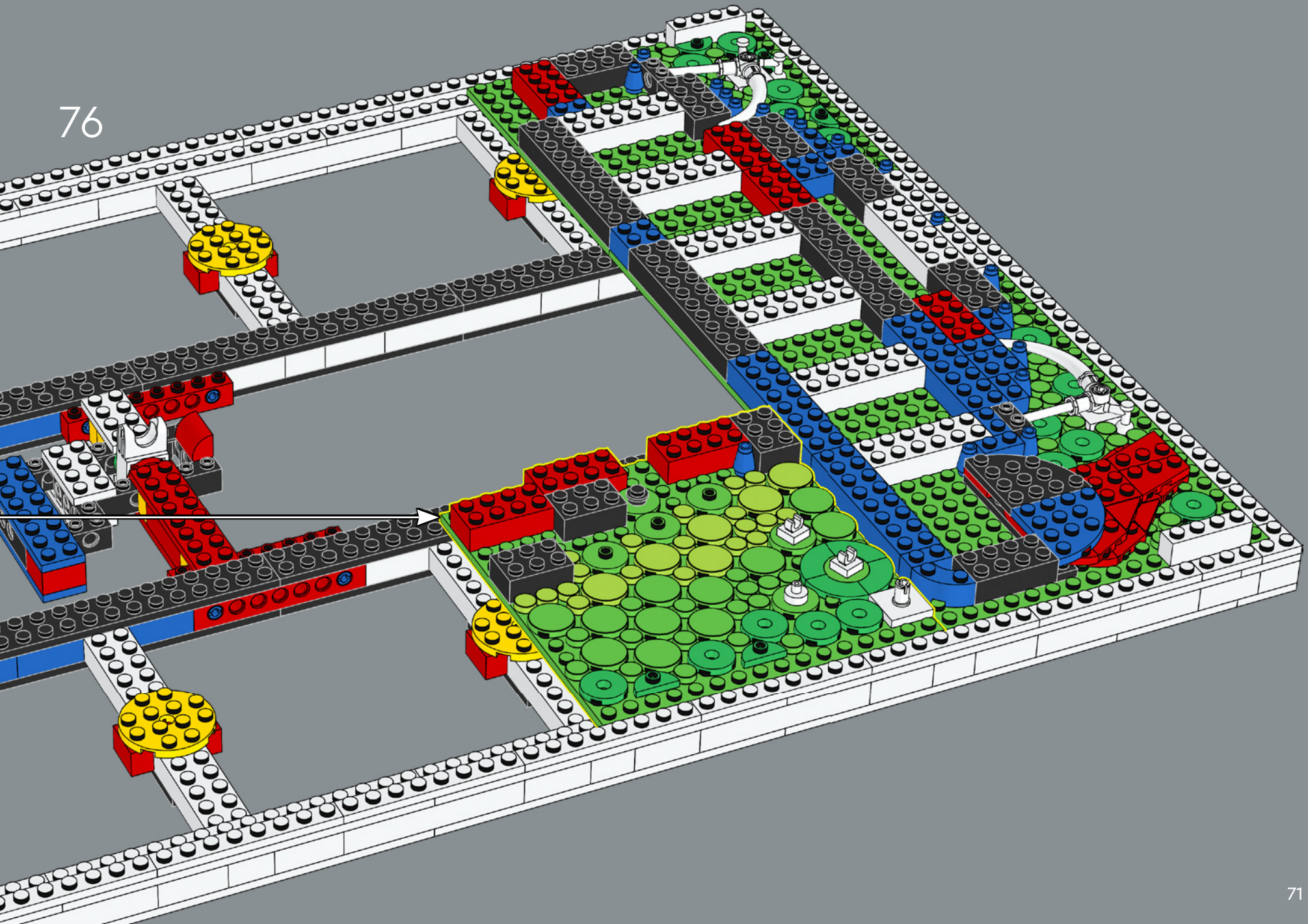

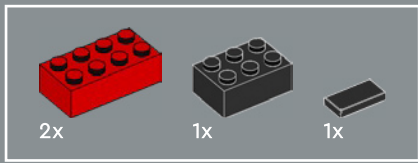

79

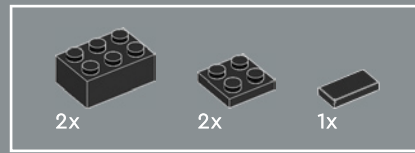
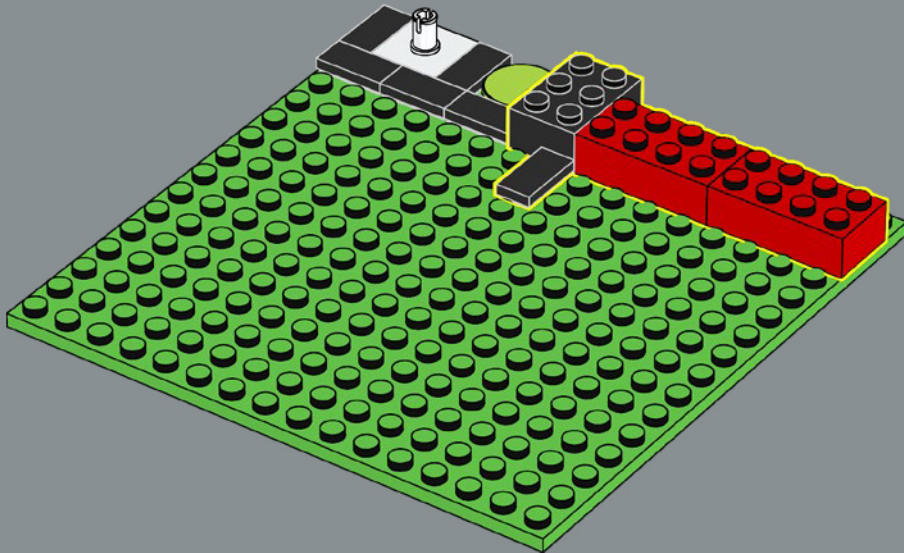

80

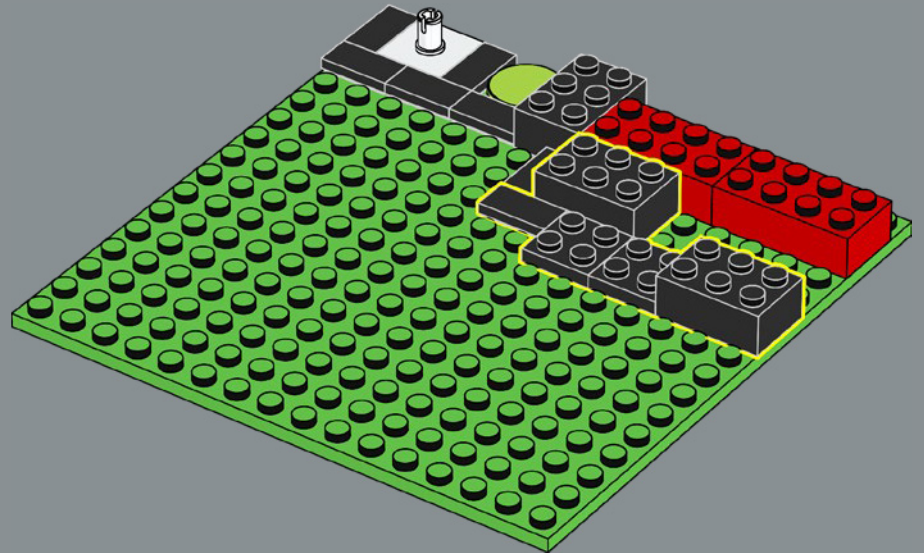

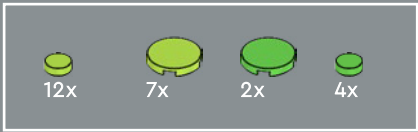

81

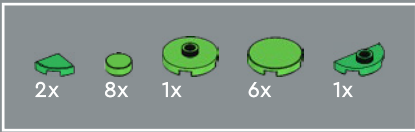
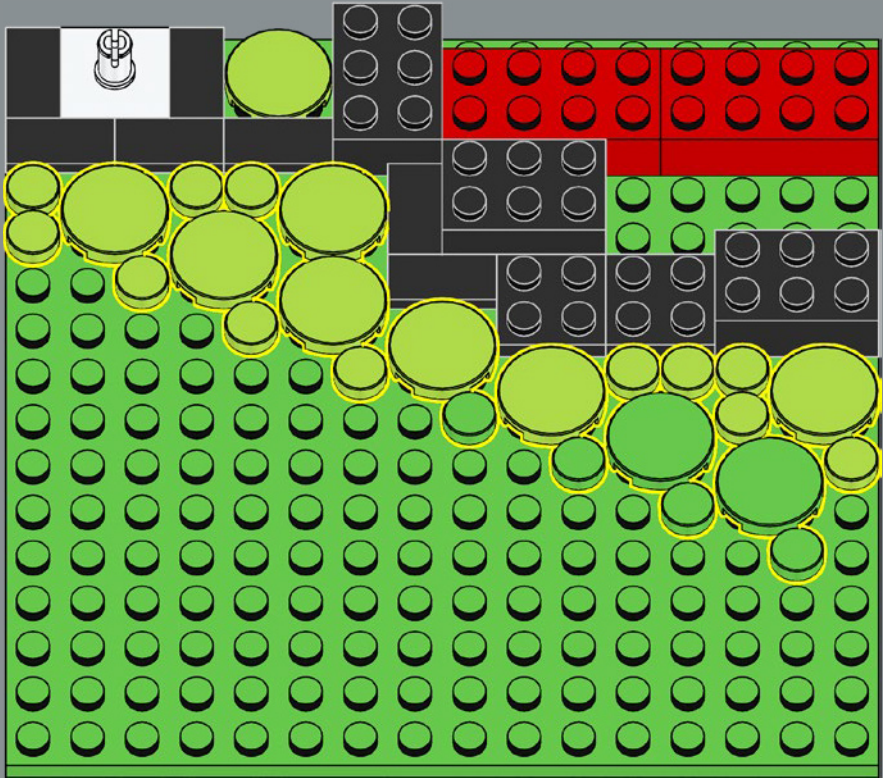

82

Sometimes applications of colours don't quite align in print, causing colours to bleed into the background. This building technique plays homage to this effect, and the use of the **Ben Day printing process**.

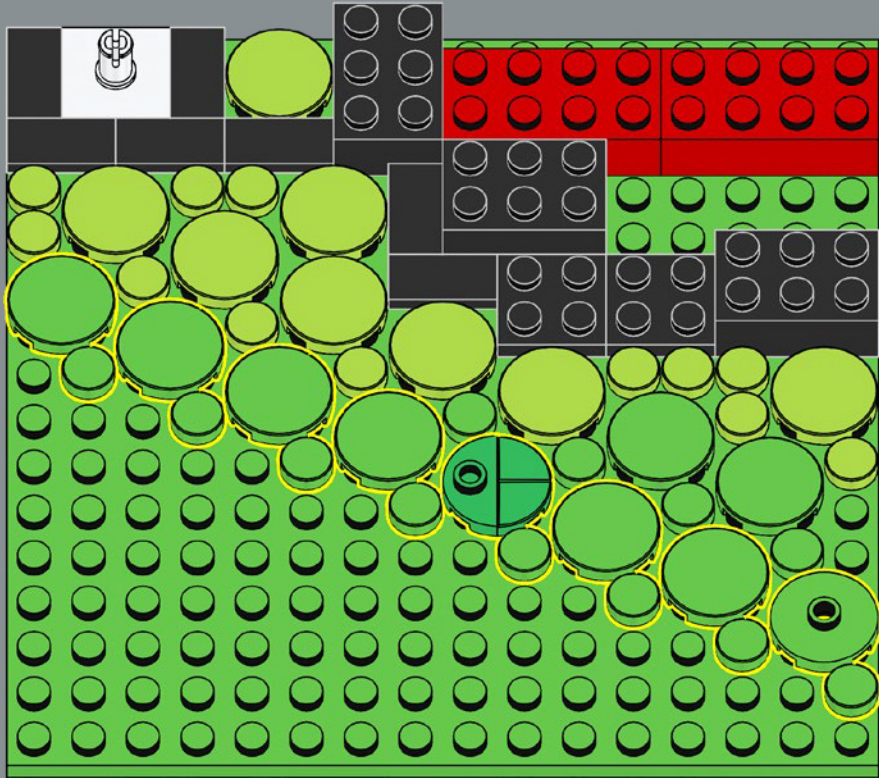

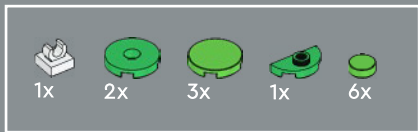

83

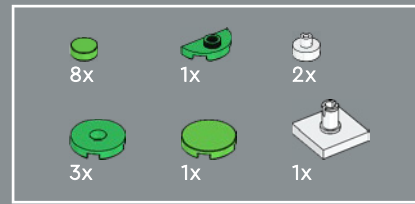
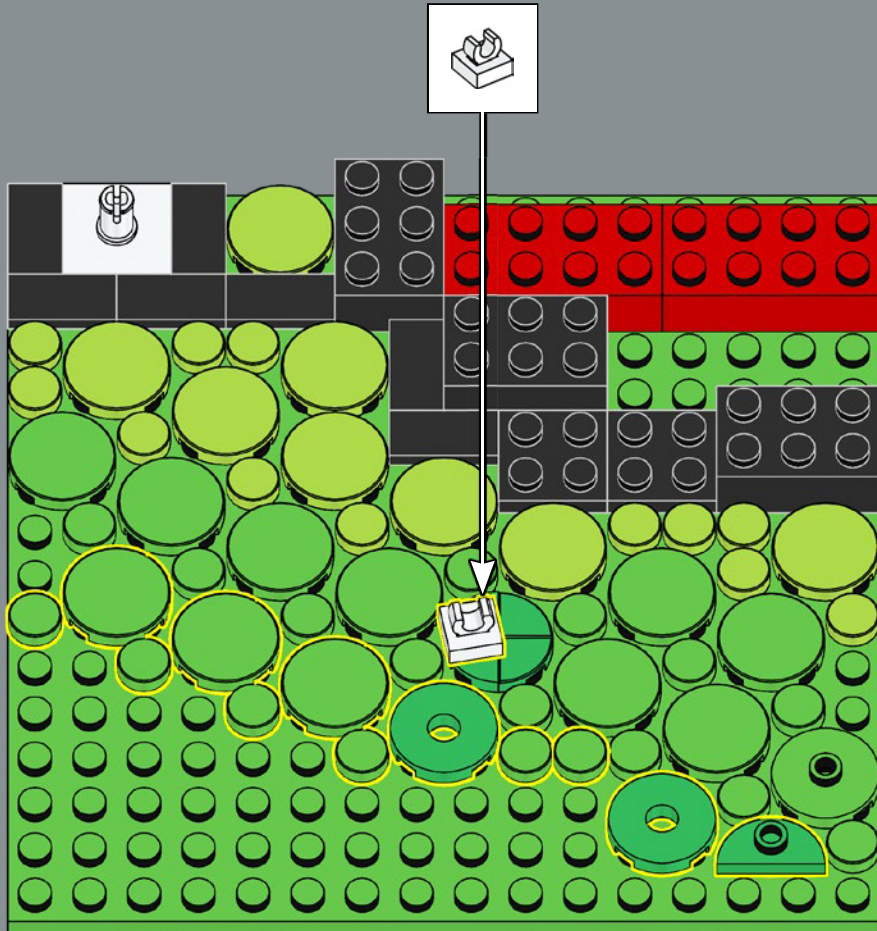

84

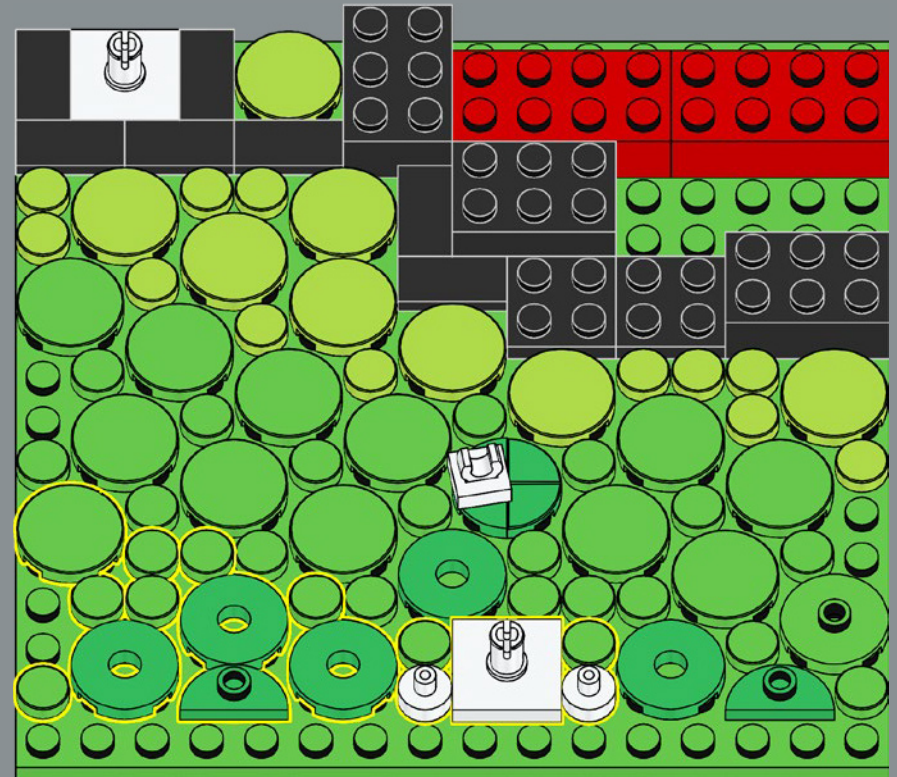

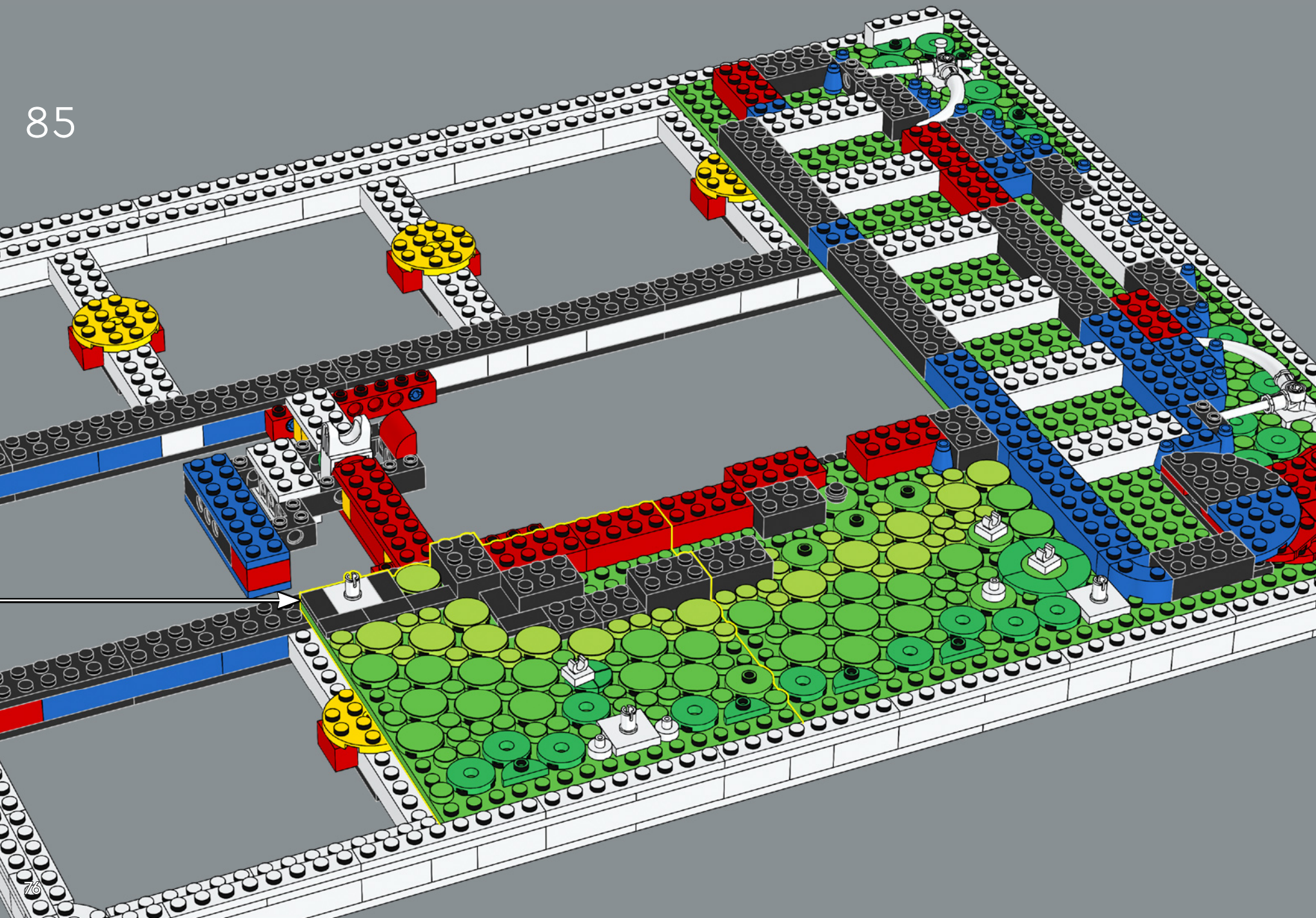

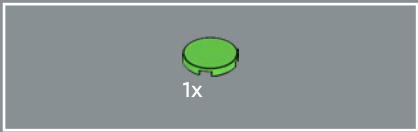

86

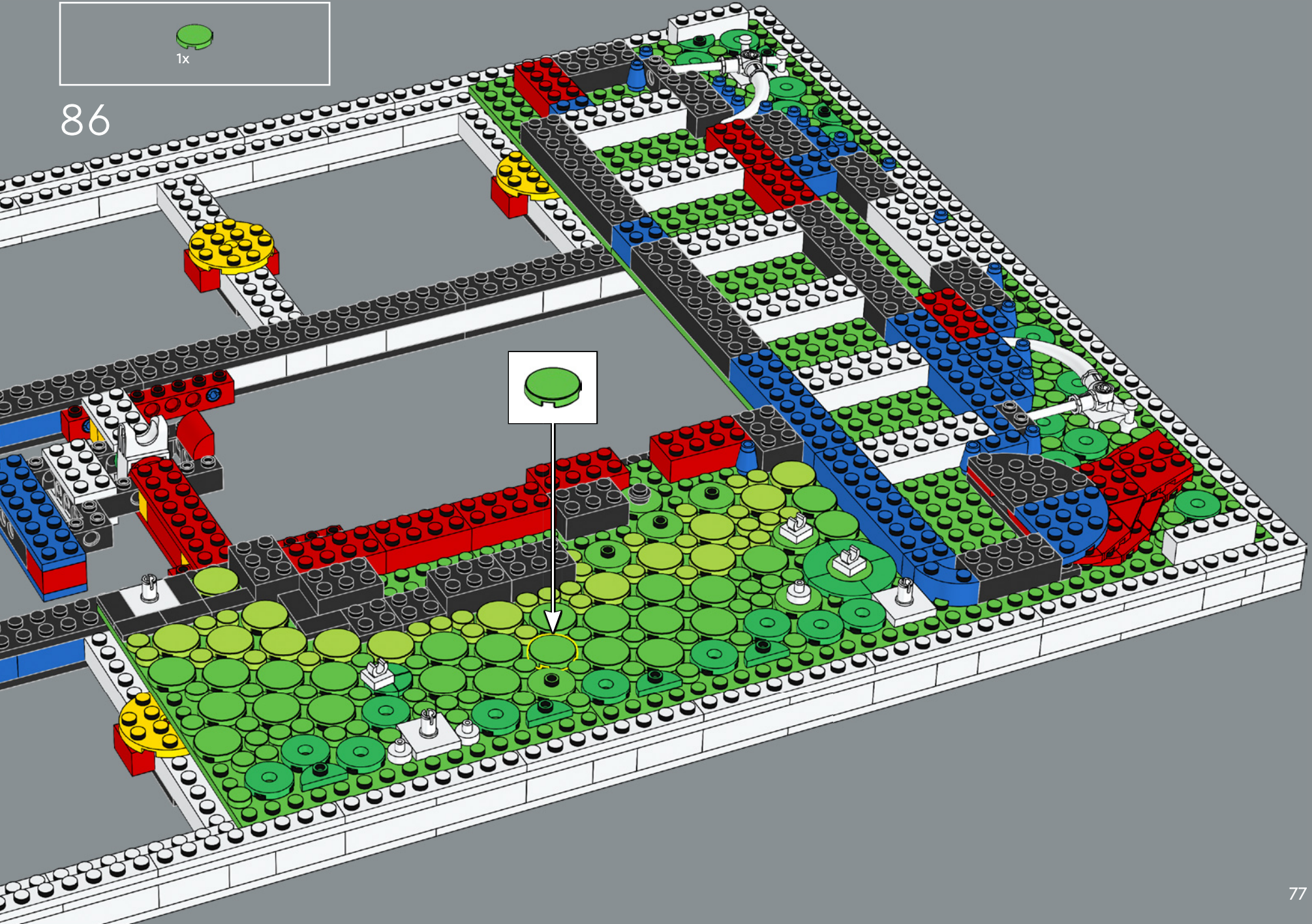

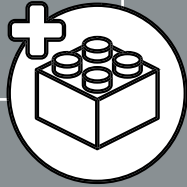
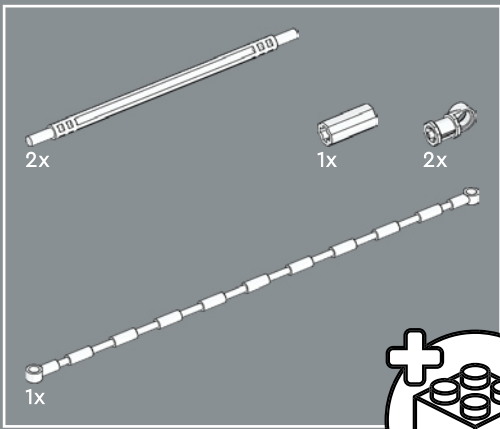

87

Spider-Man has spent long hours practicing the operation of his web... The terrific teenager can now use it in many different ways!
- Thwip!

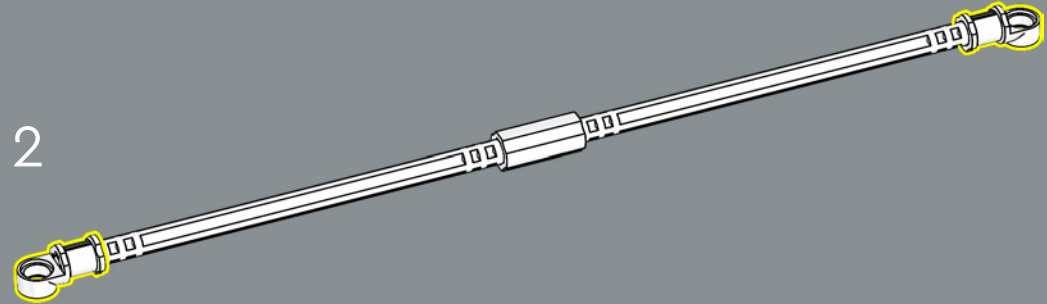
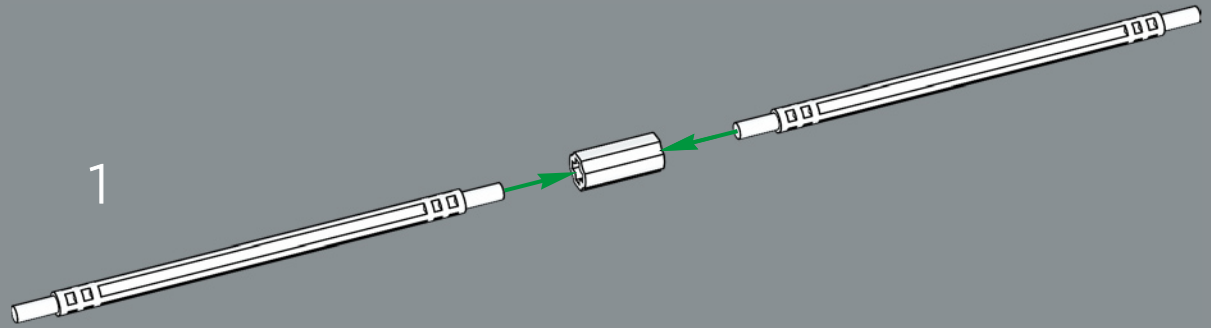

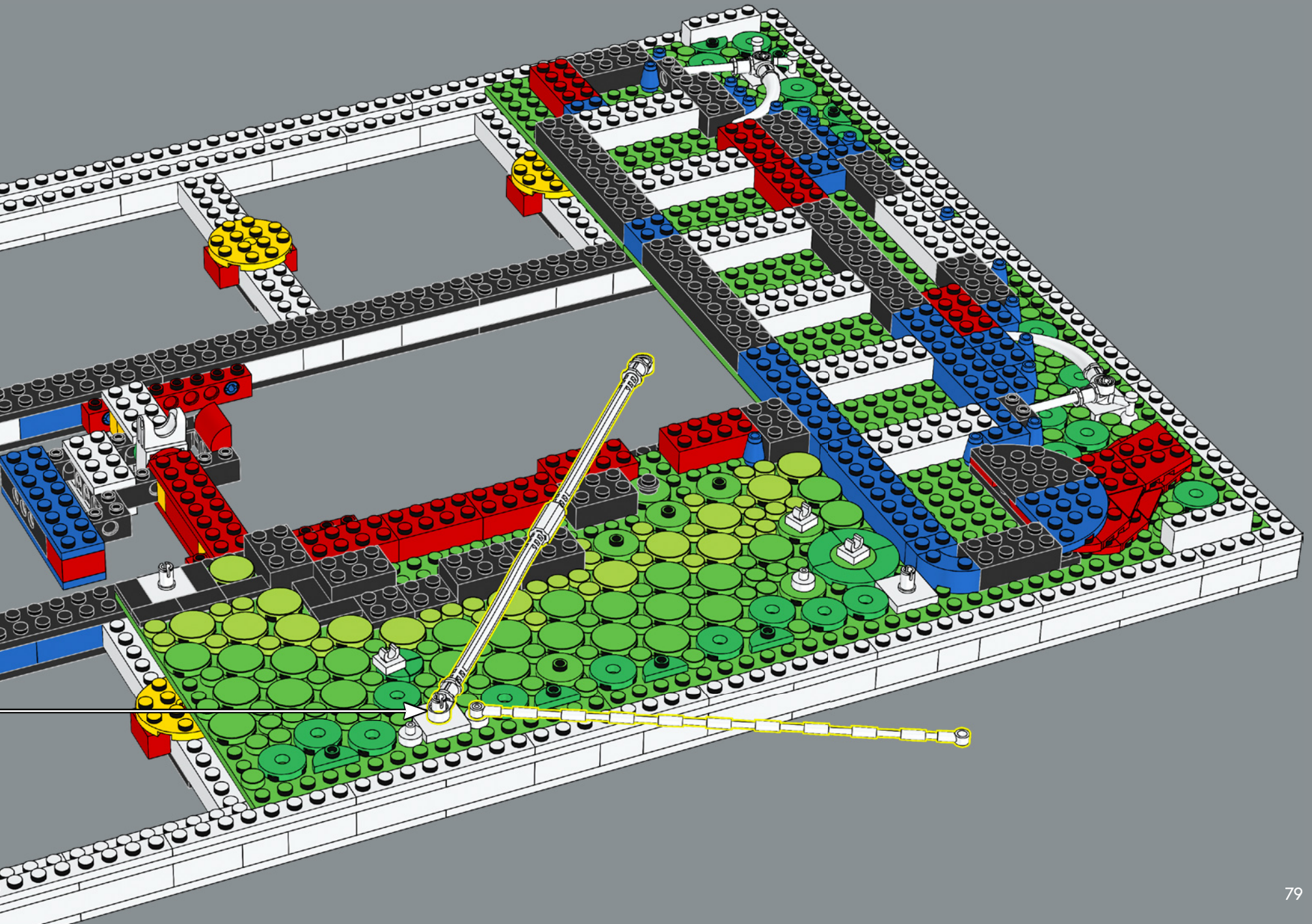

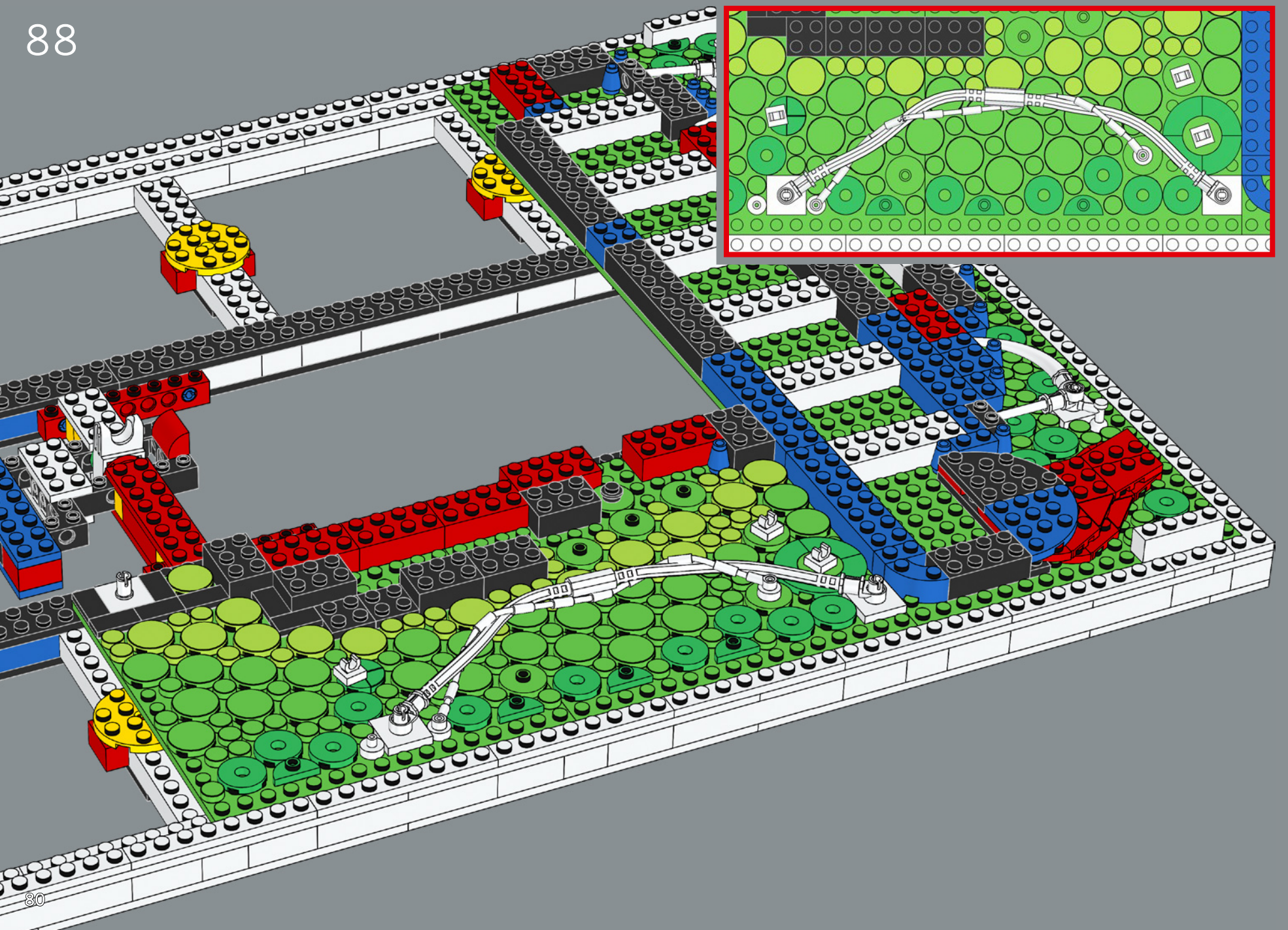

1x  1x 

89

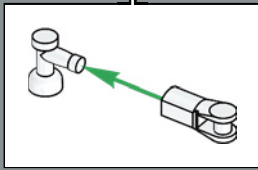
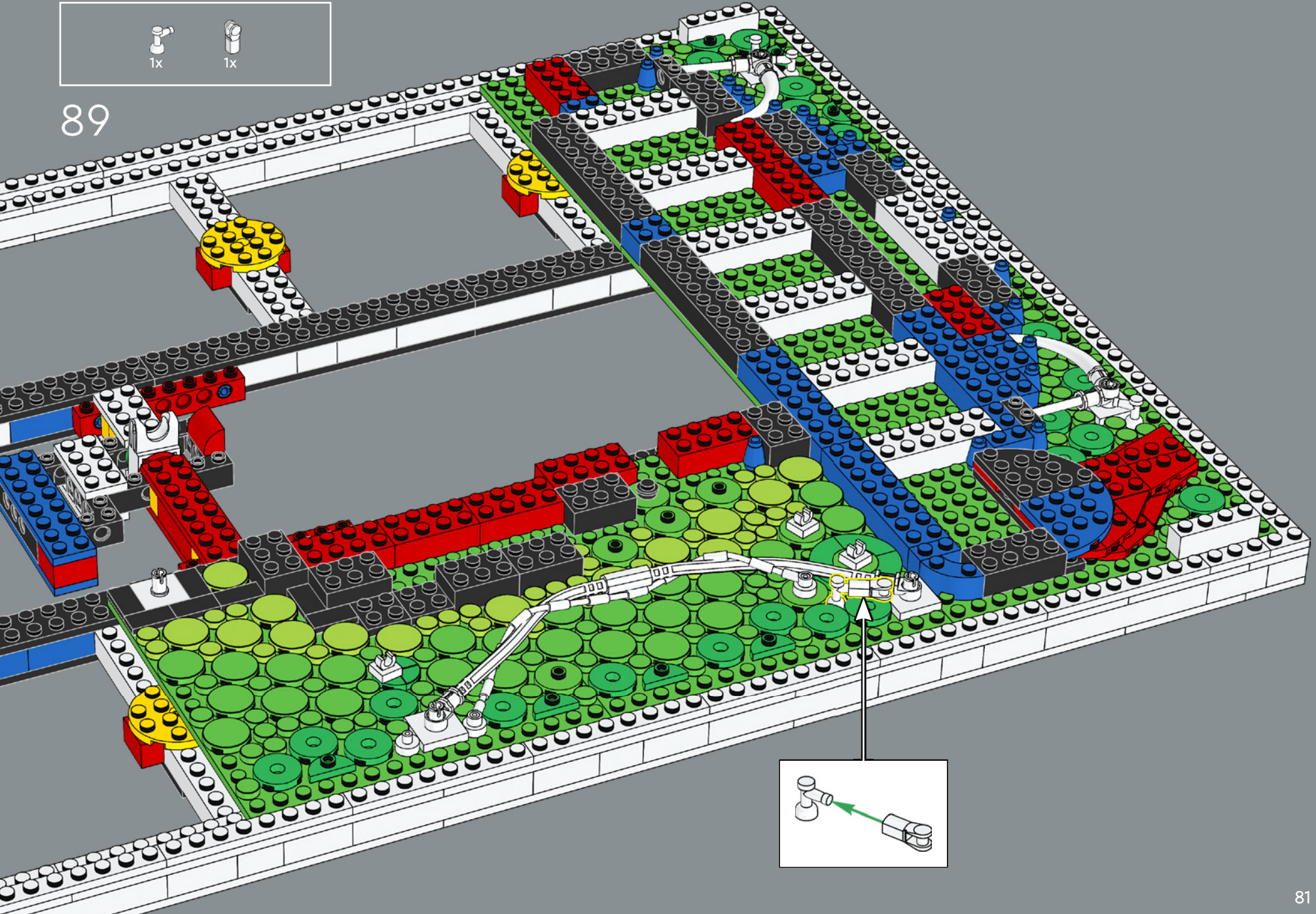

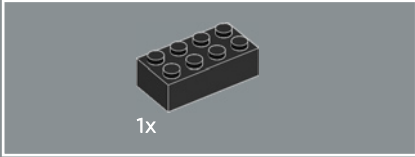
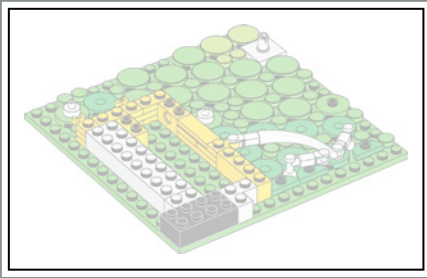
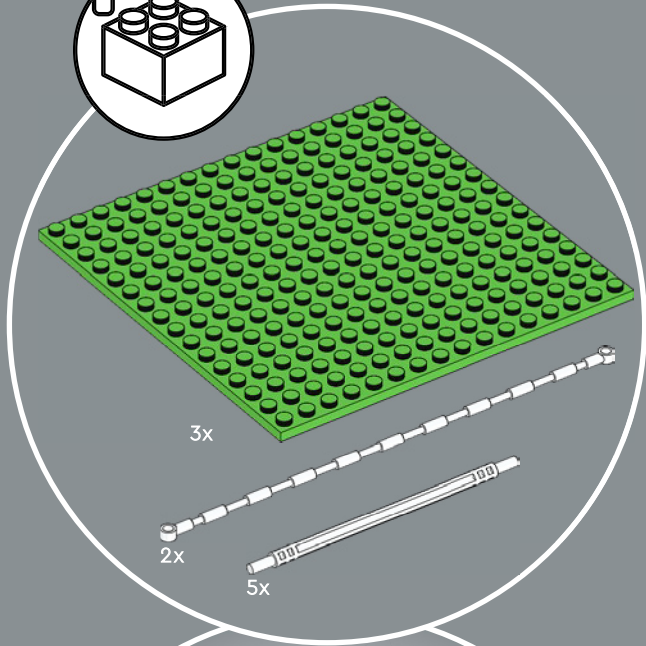
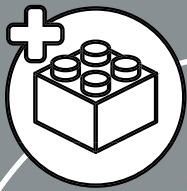

90

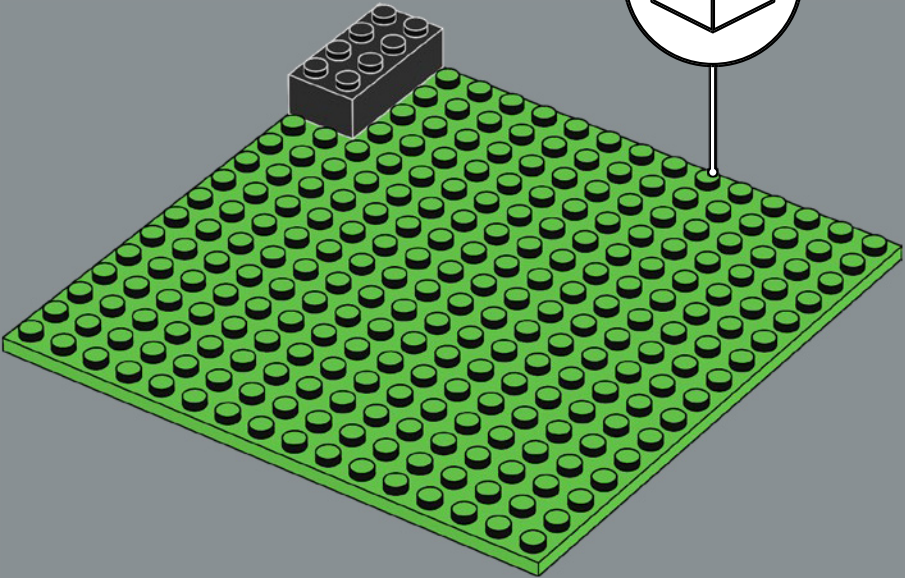
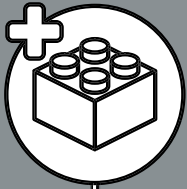

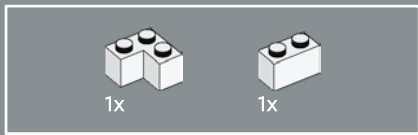

91

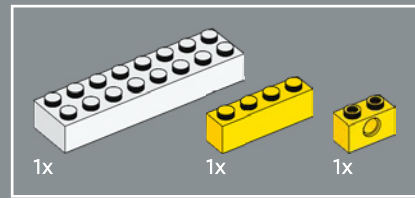
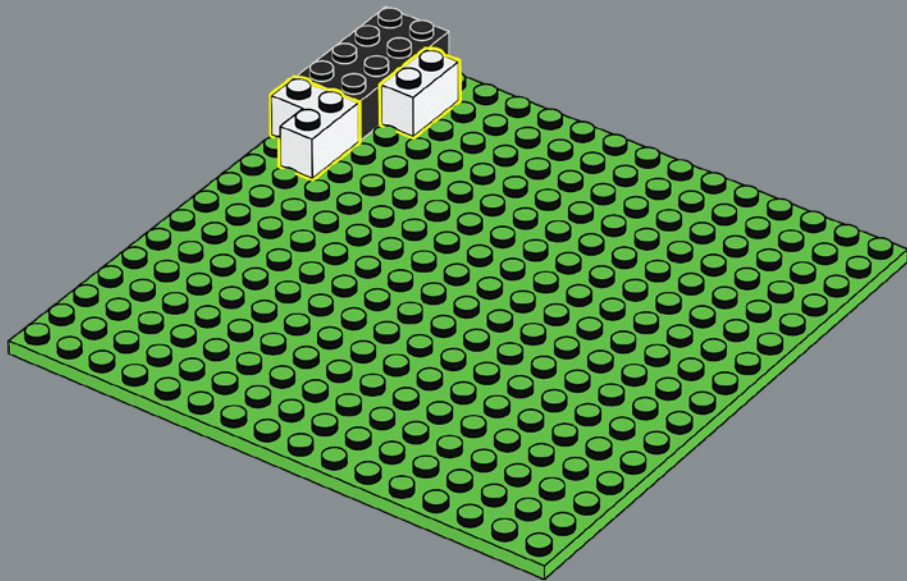

92

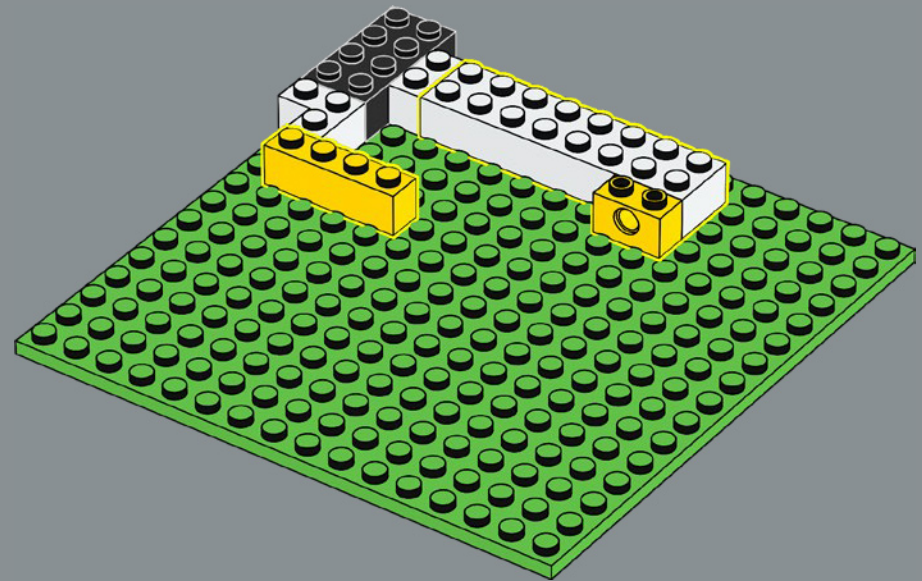

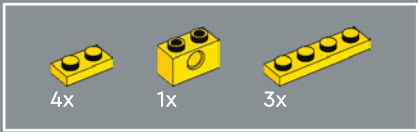

93

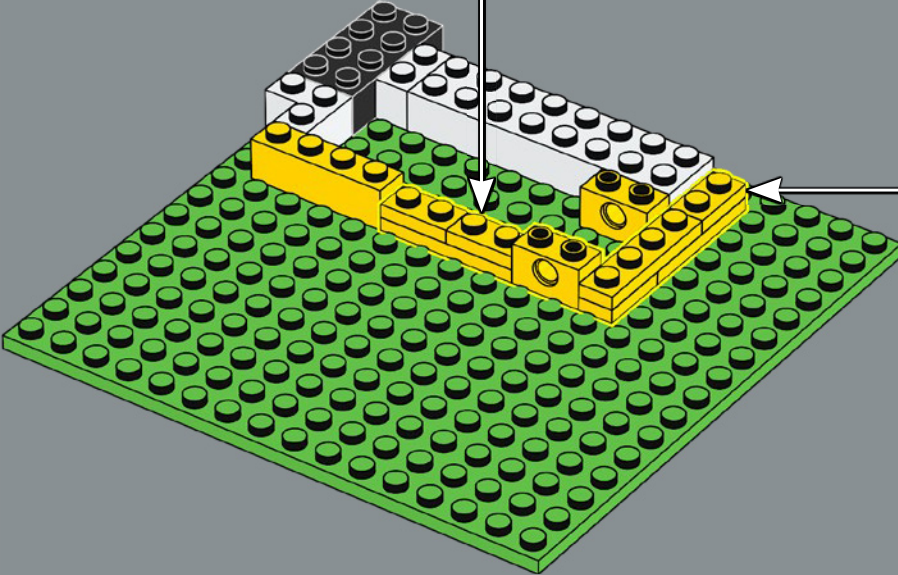
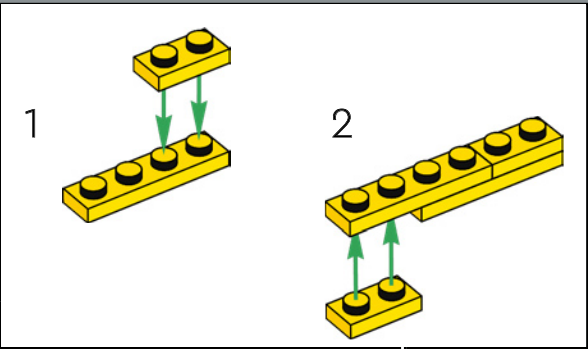
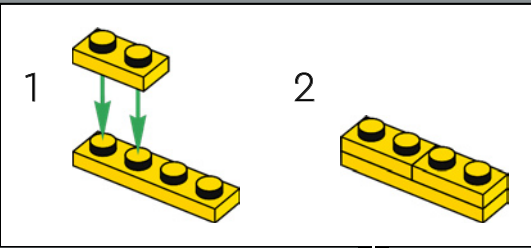

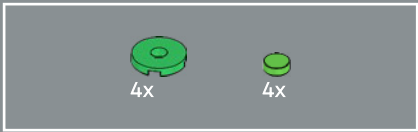

96

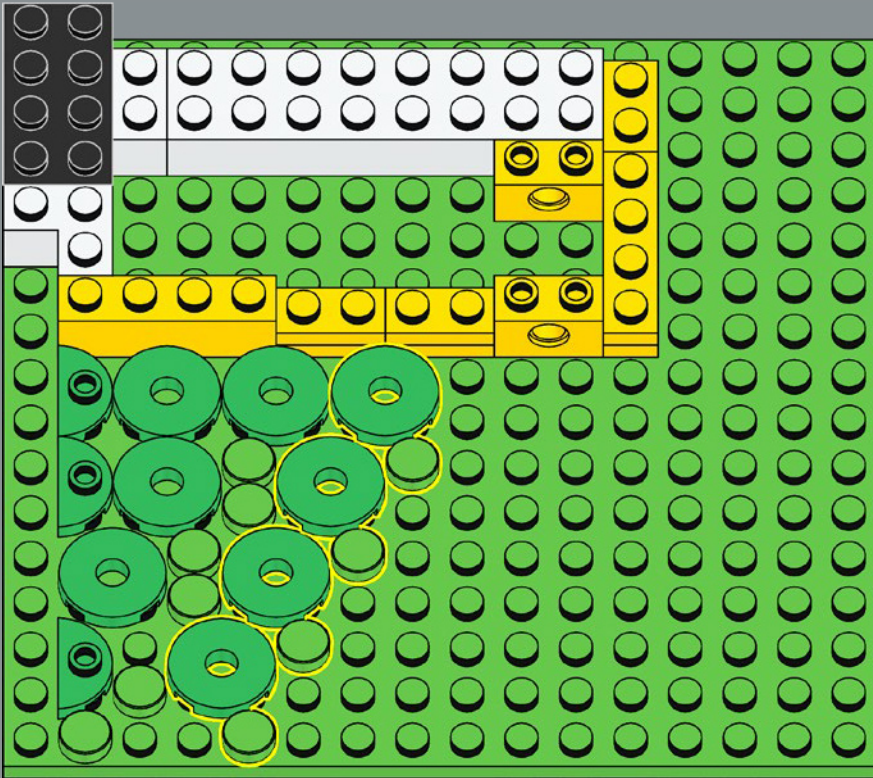

97

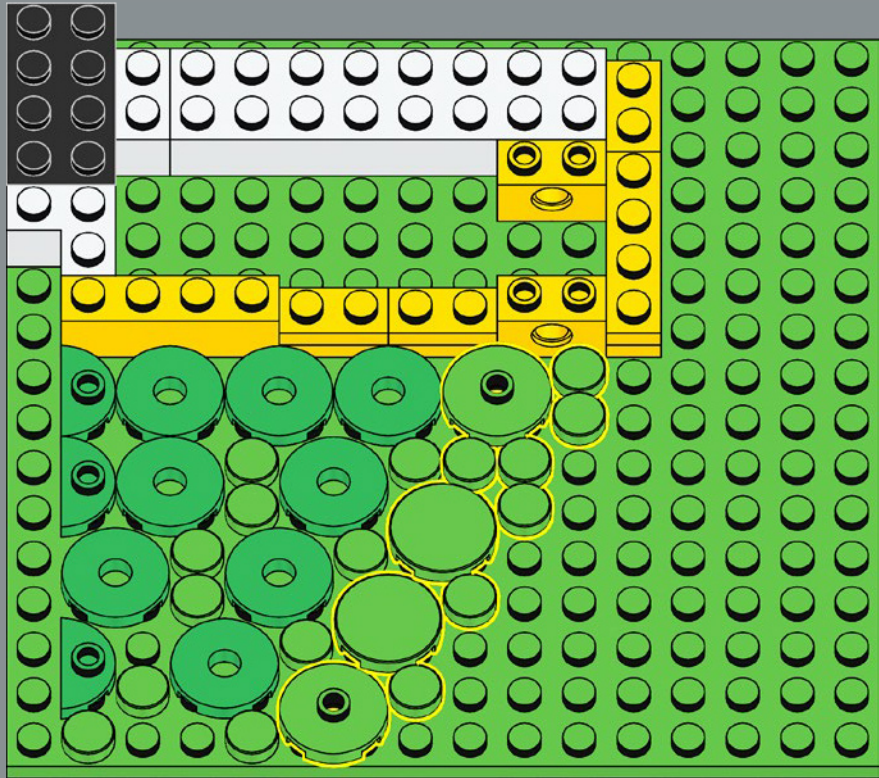

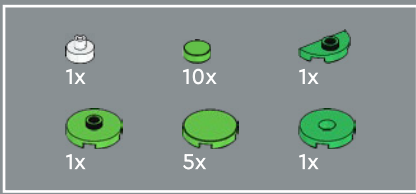

98

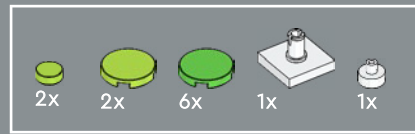
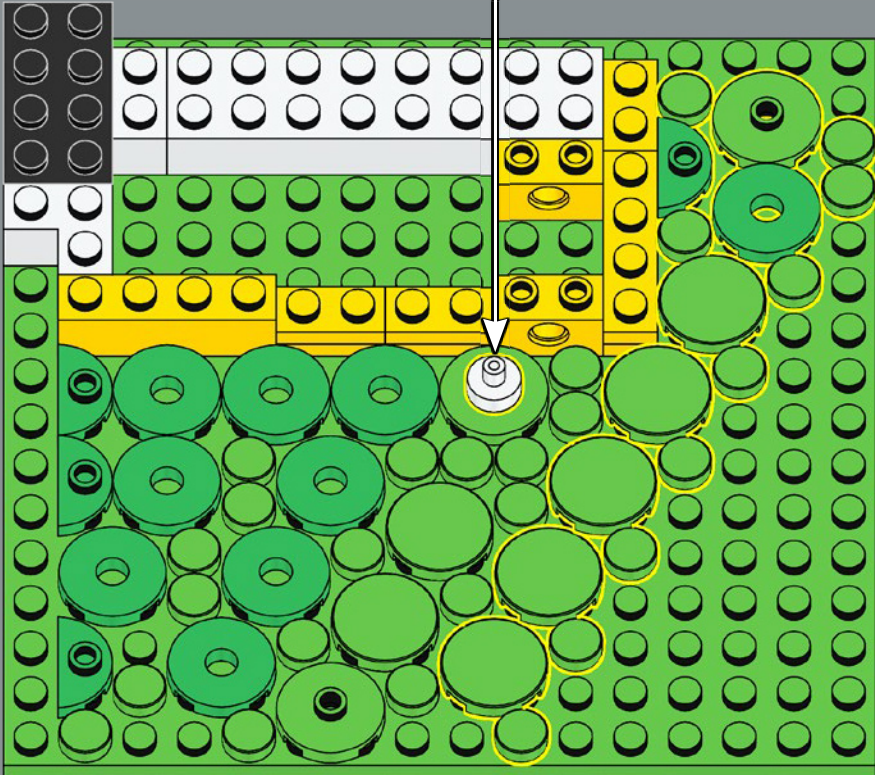

99

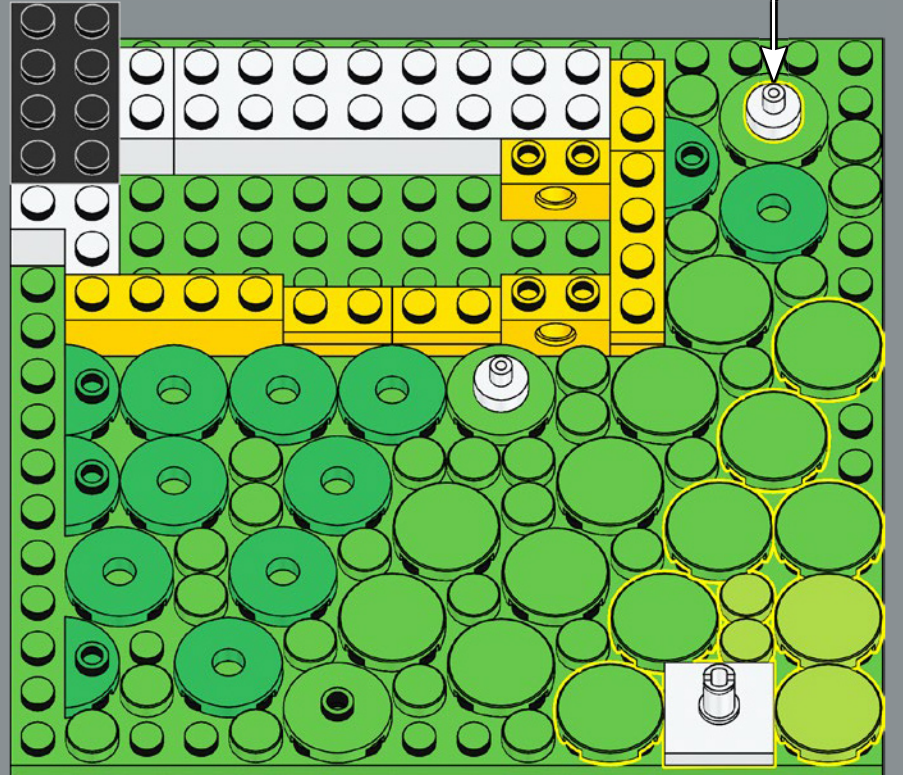

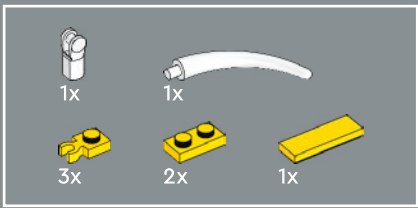

100

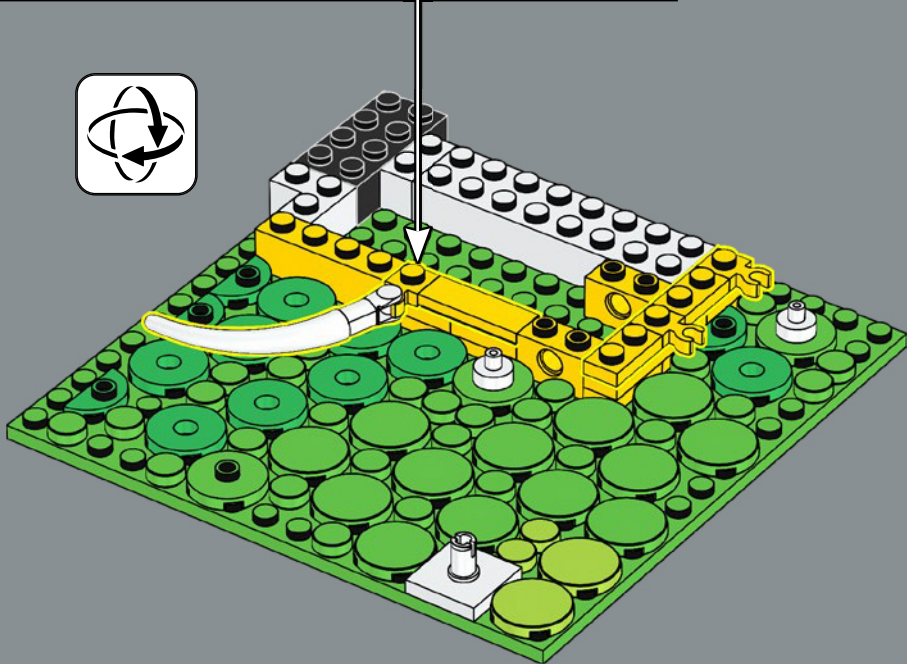
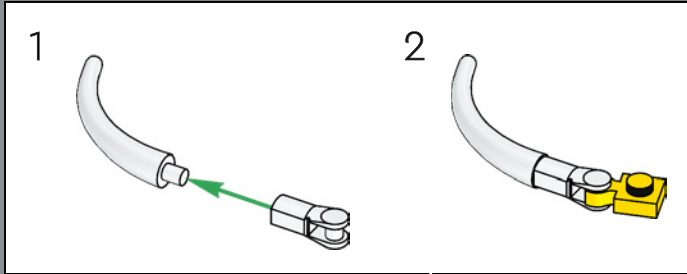

101

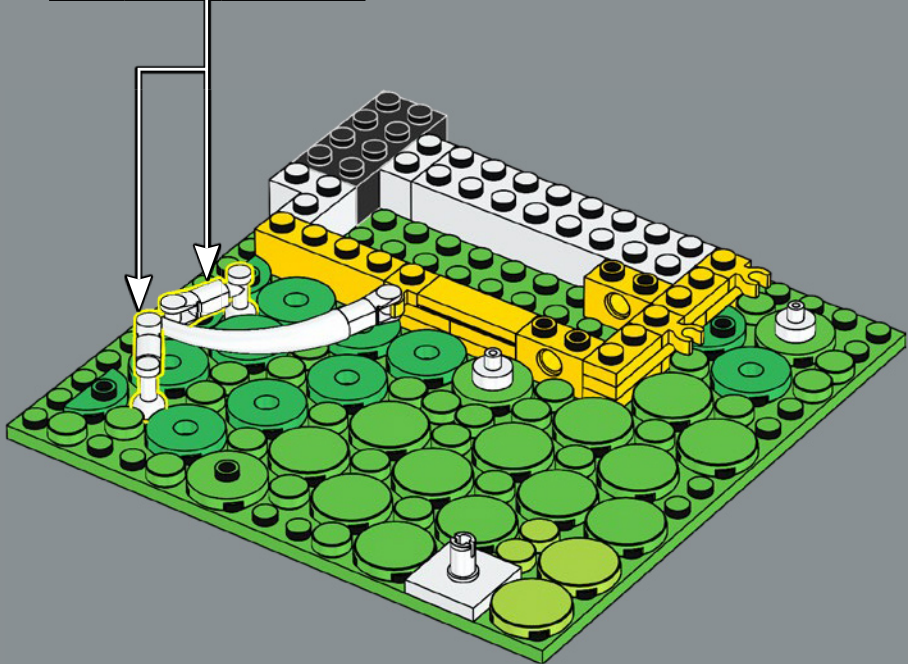
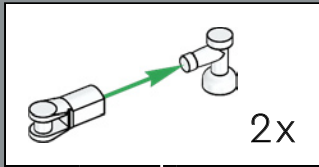

102

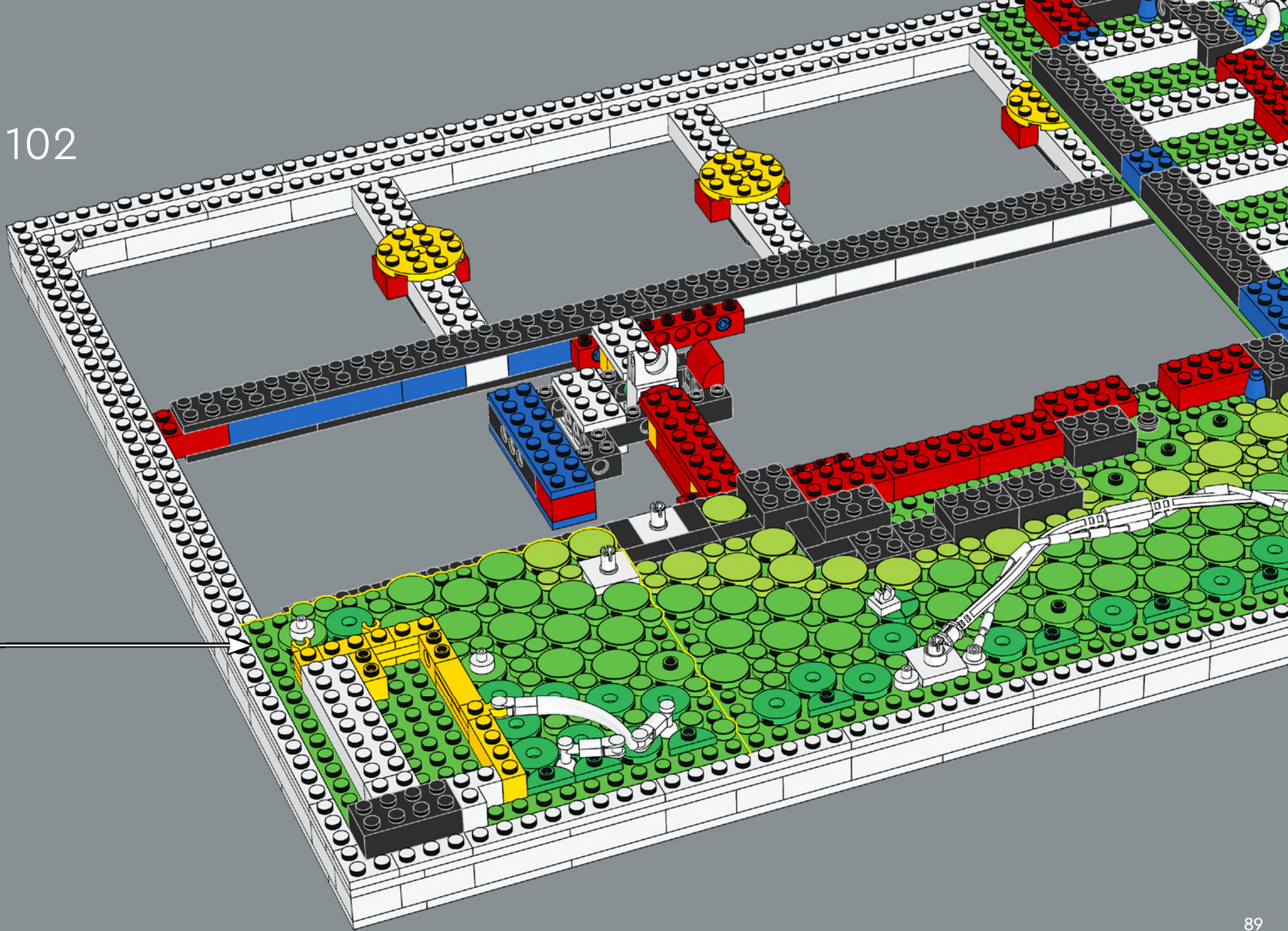

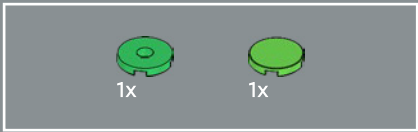

103

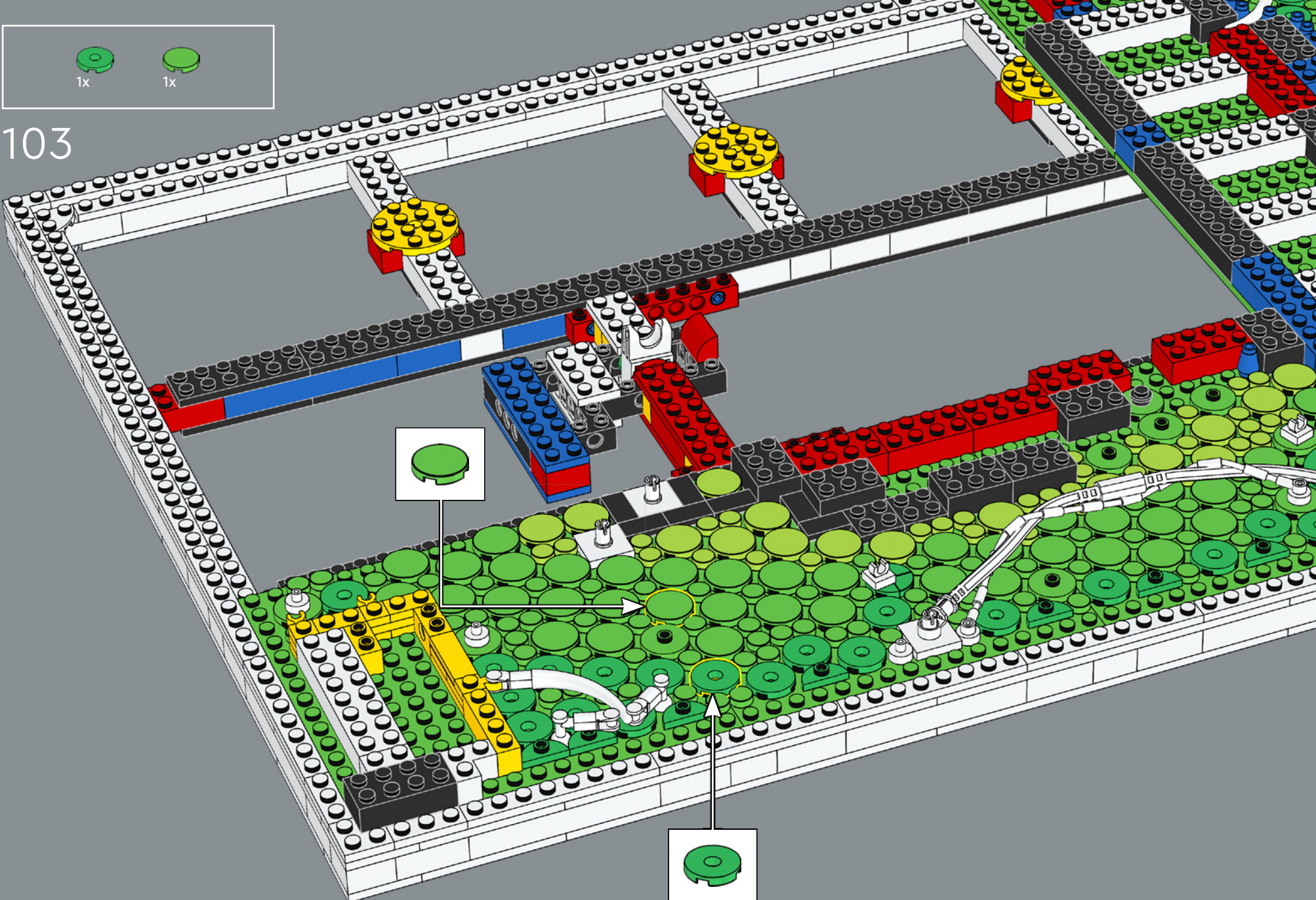

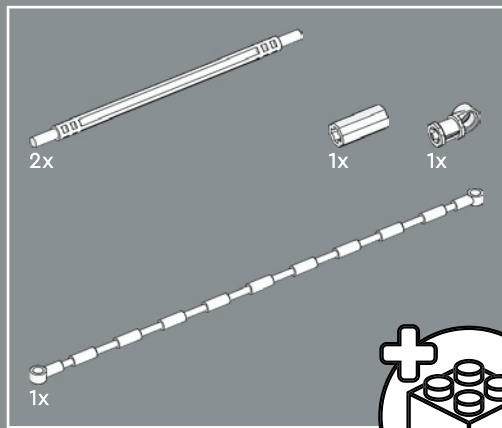

104

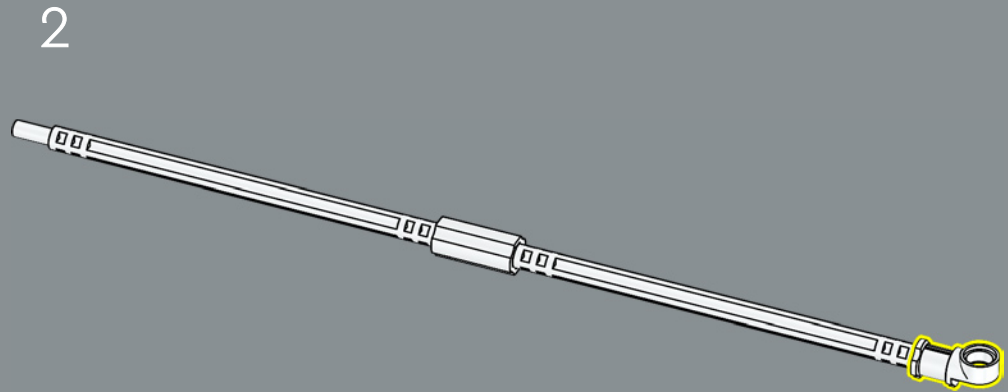
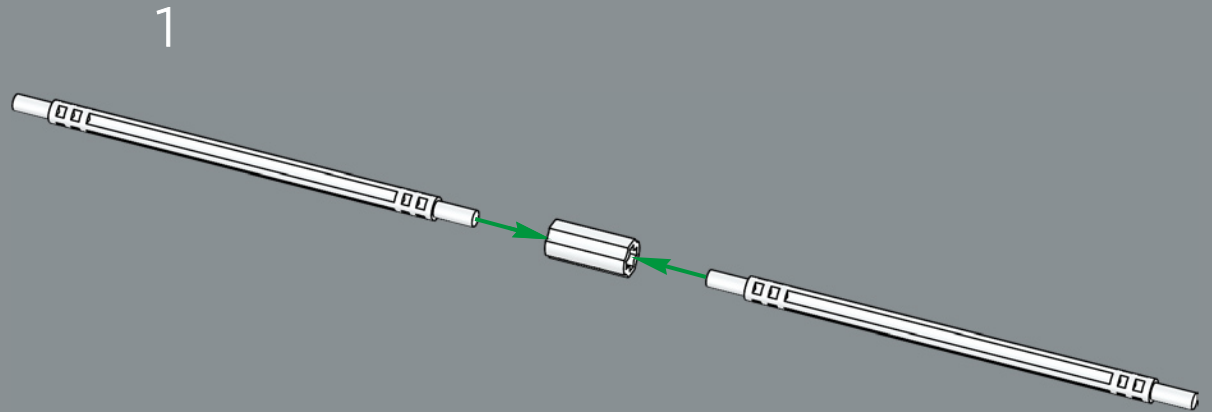
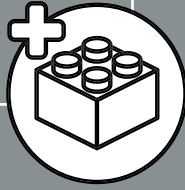

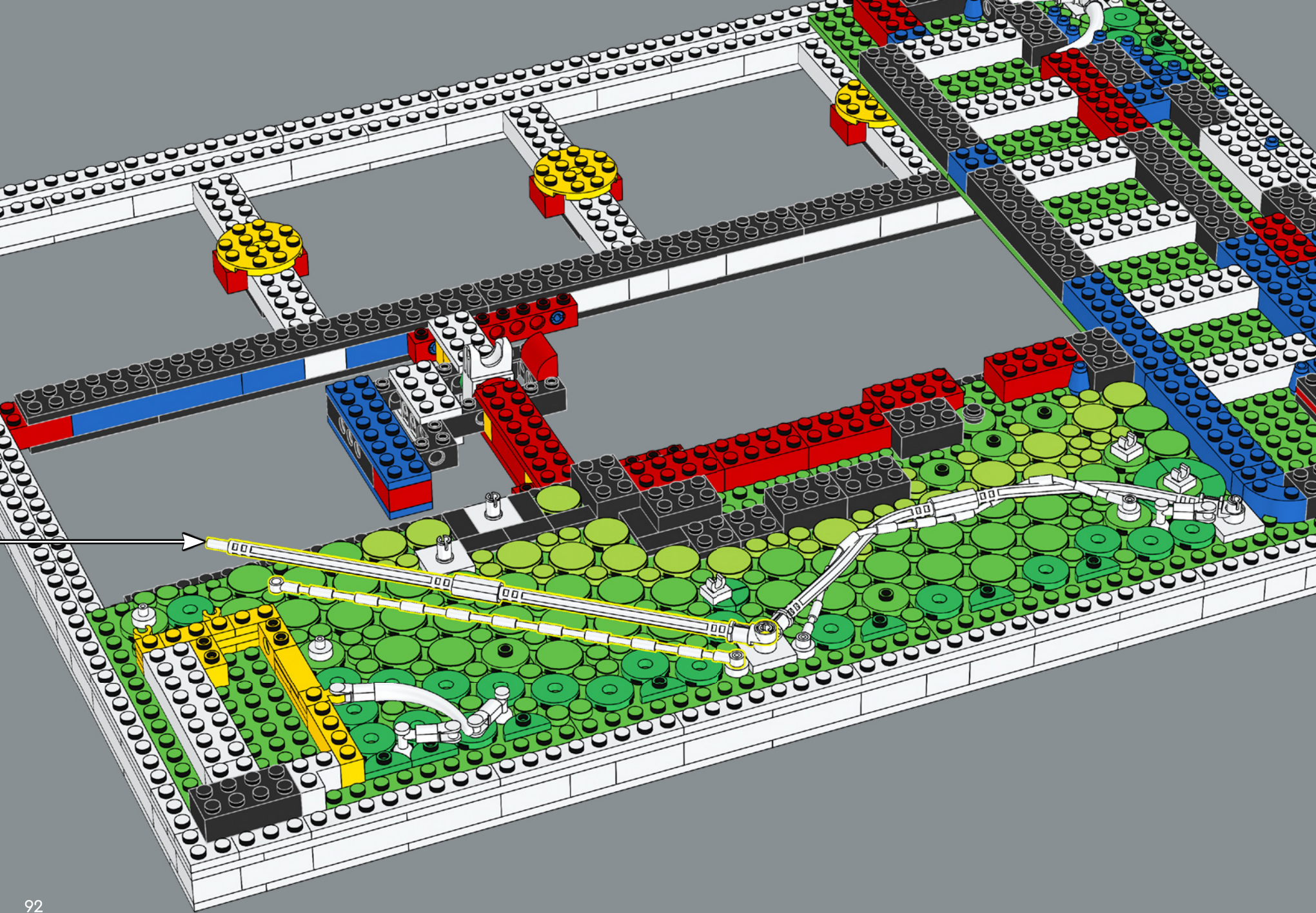

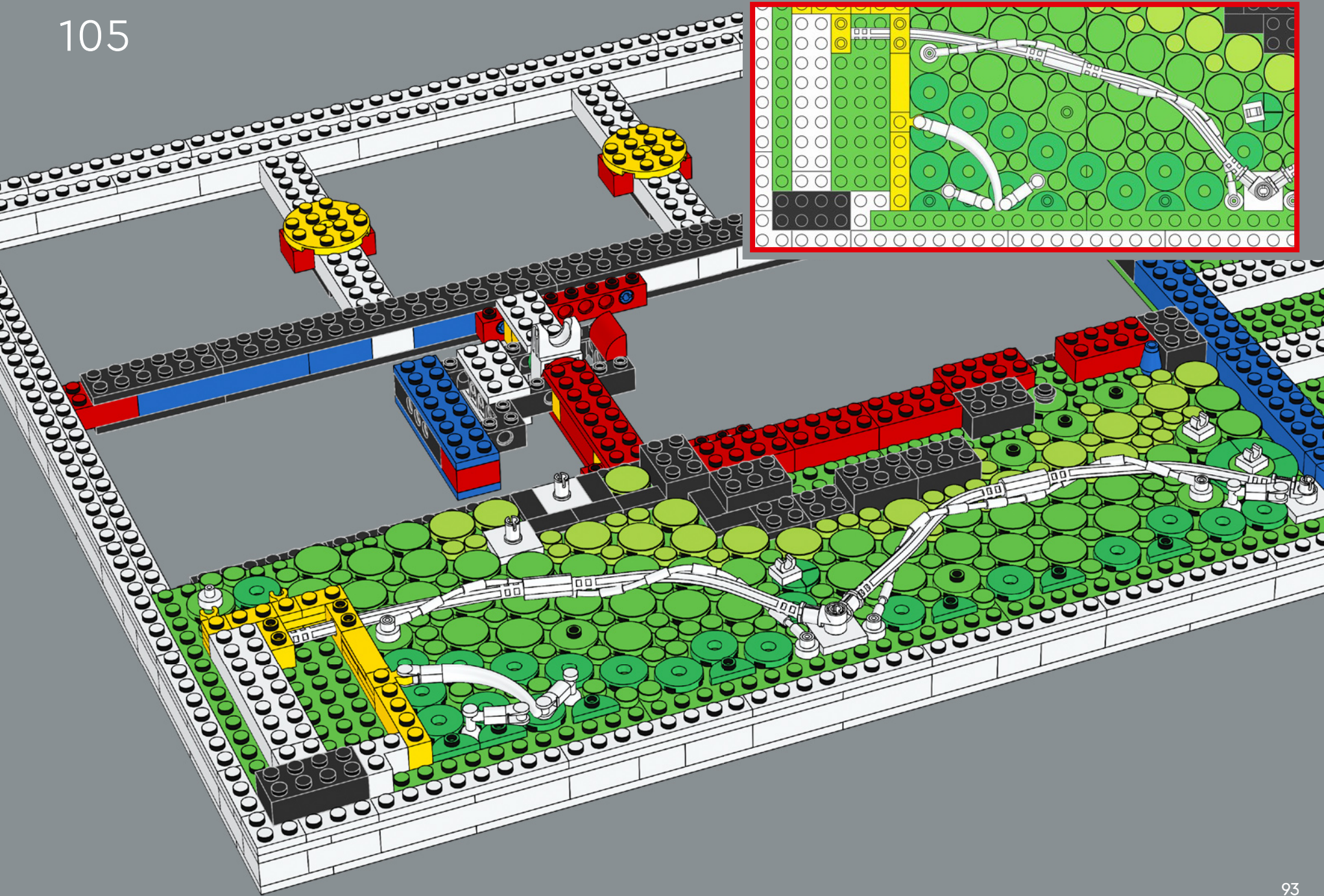

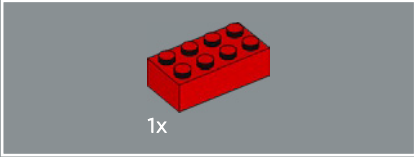
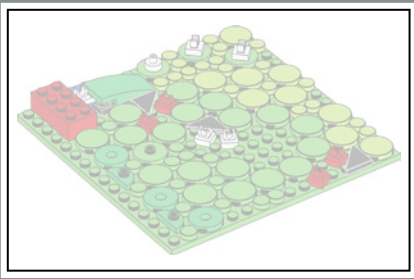

106

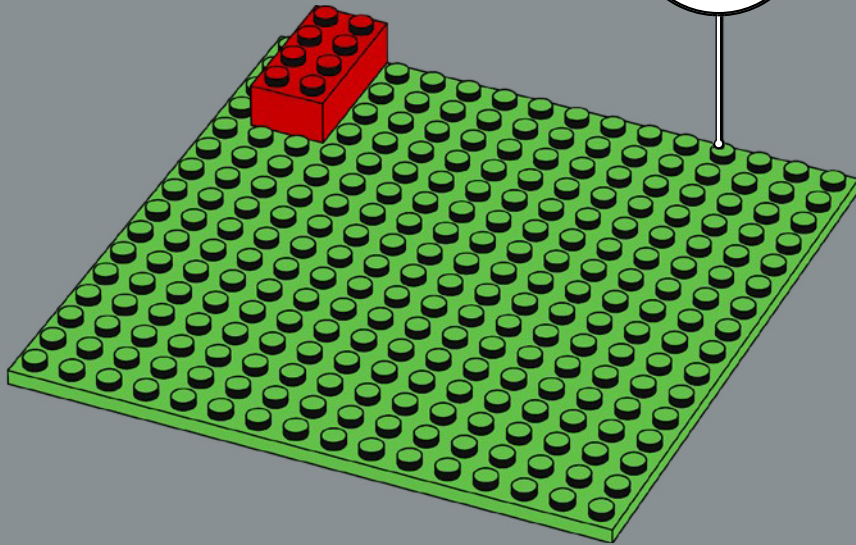
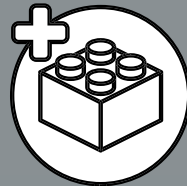

107

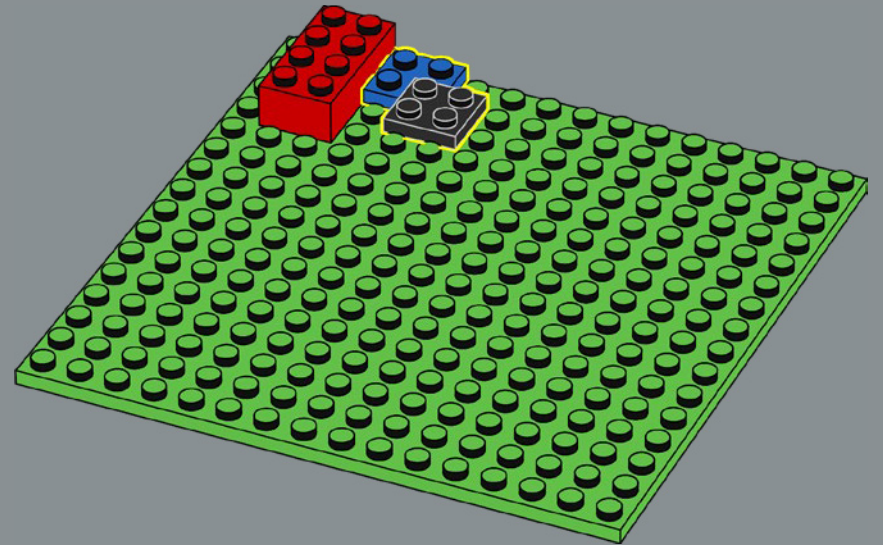

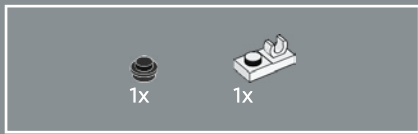

108

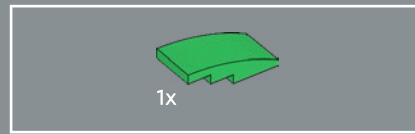
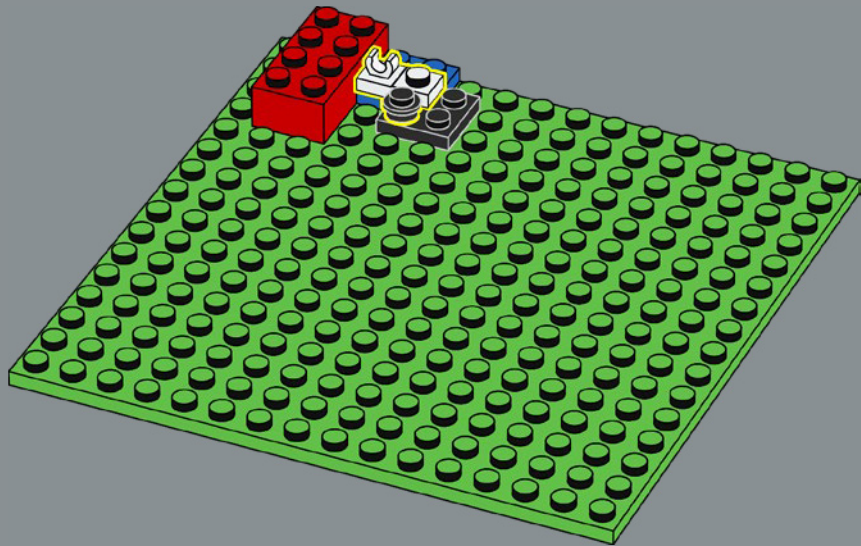

109

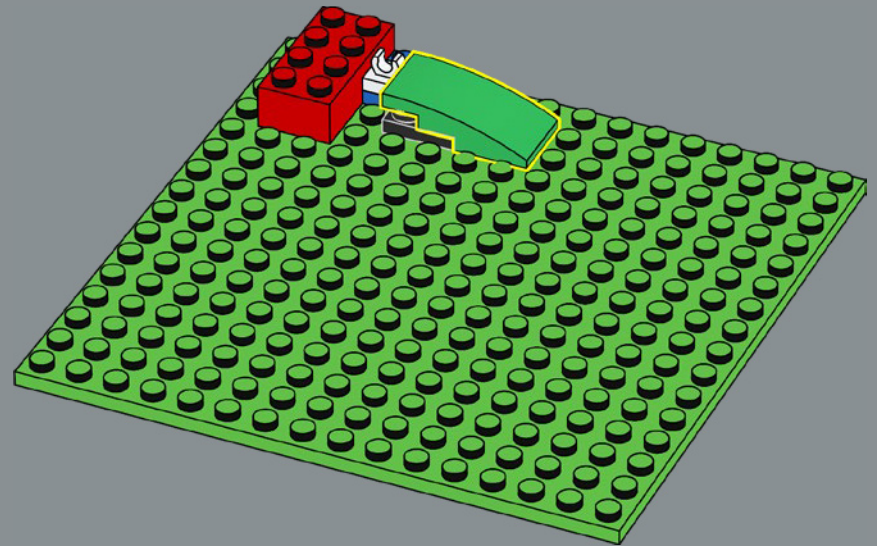



110

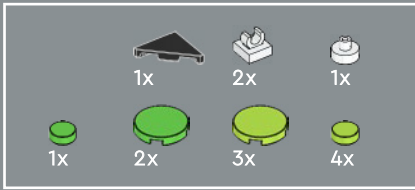
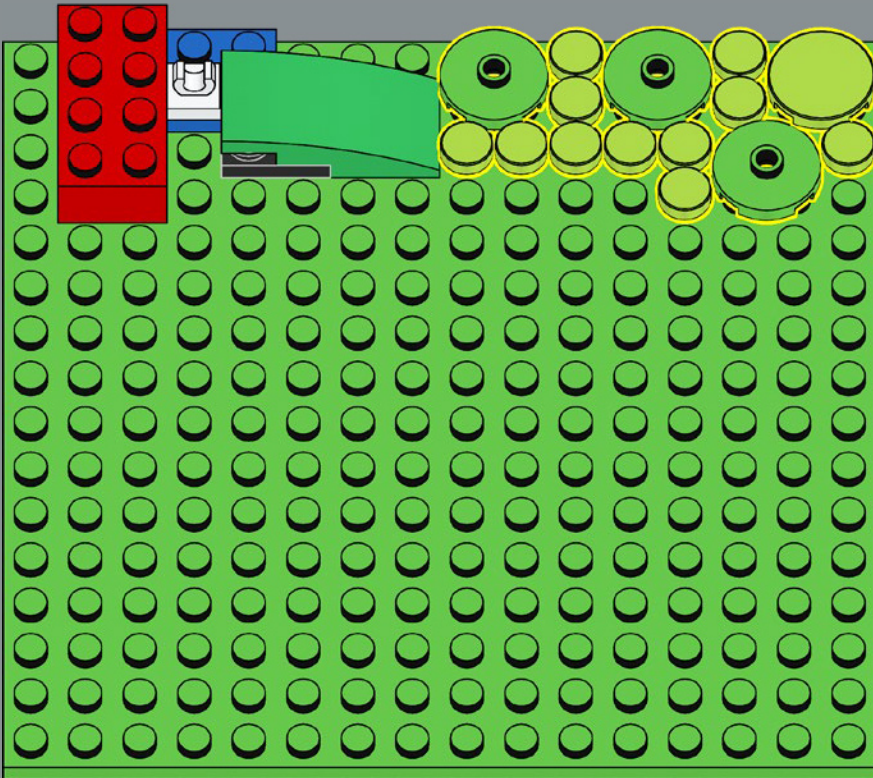

111

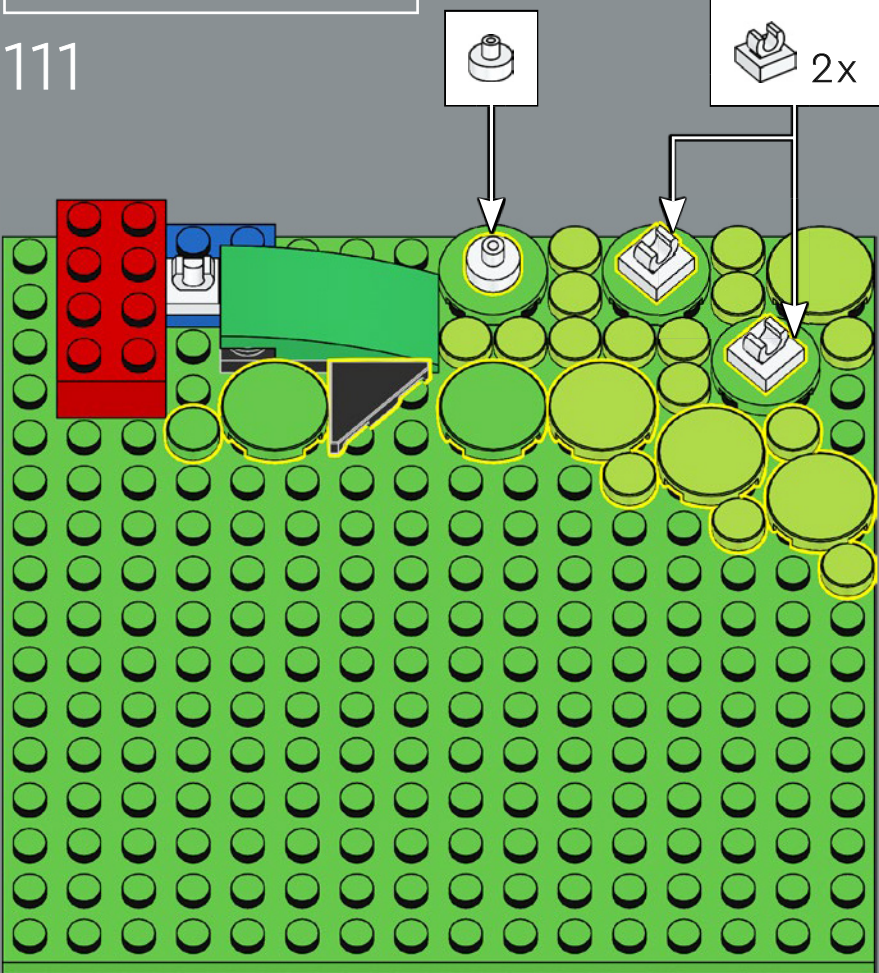

118

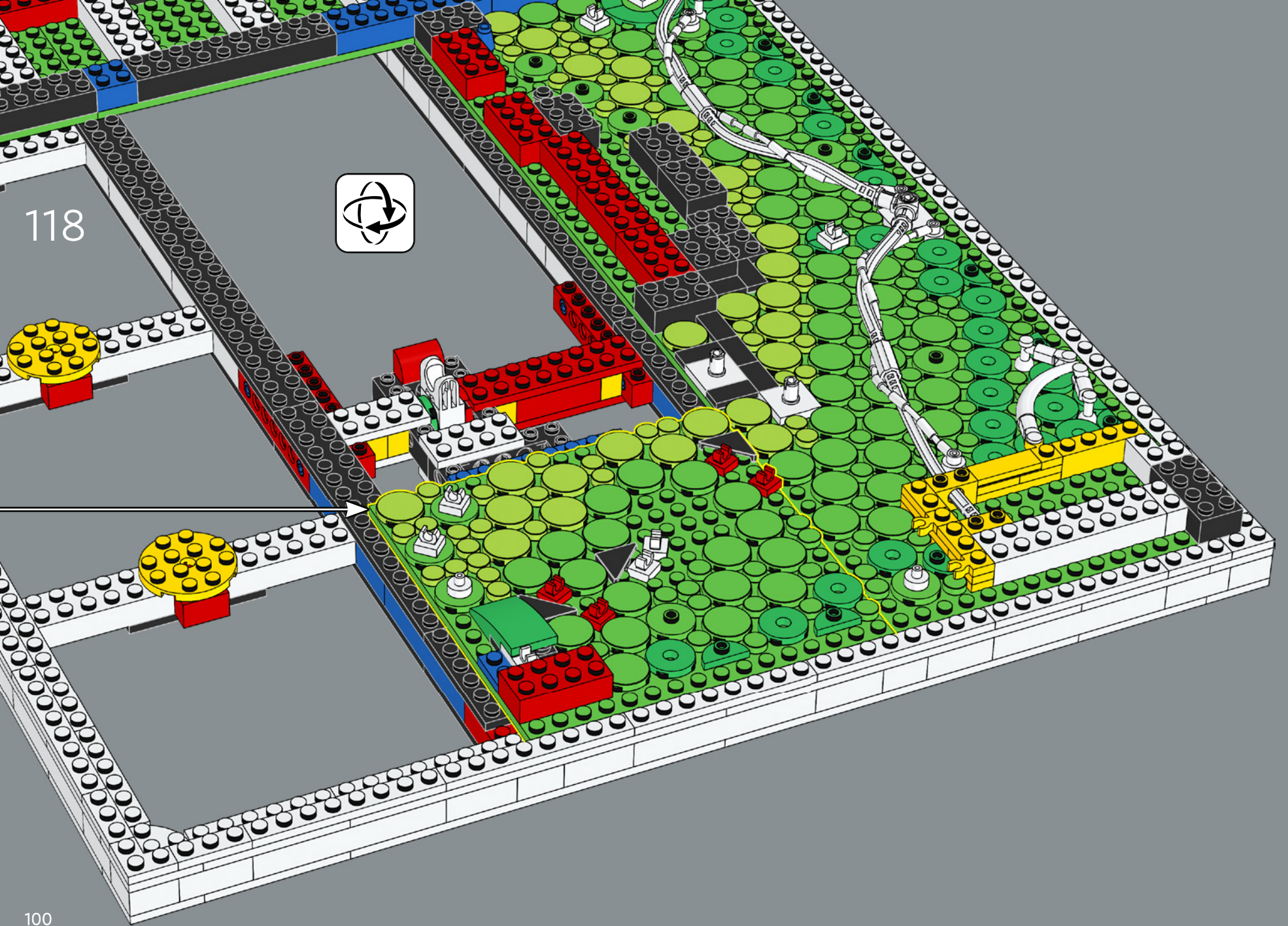

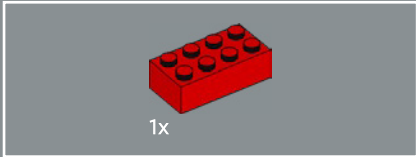
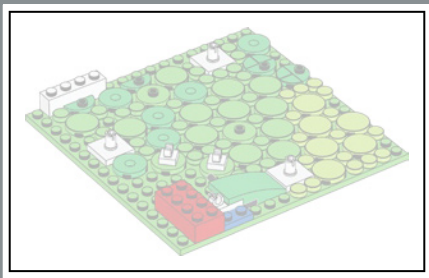

119

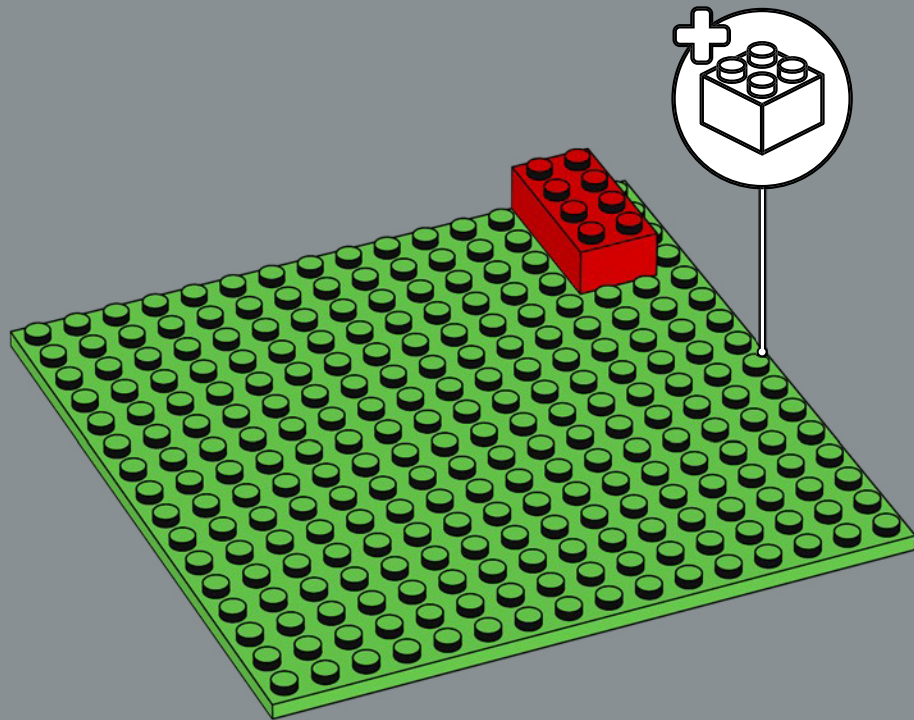

120

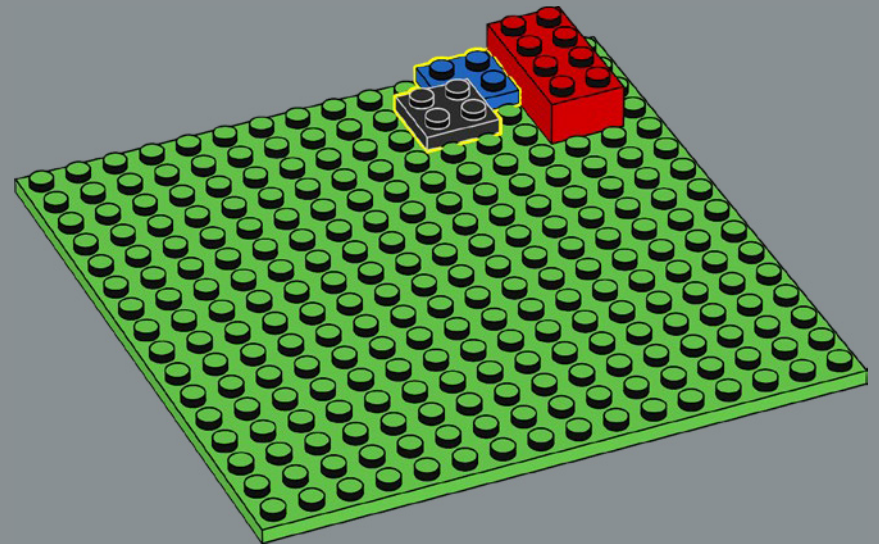



121

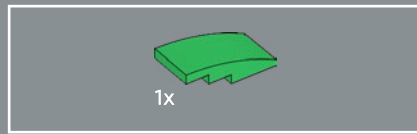
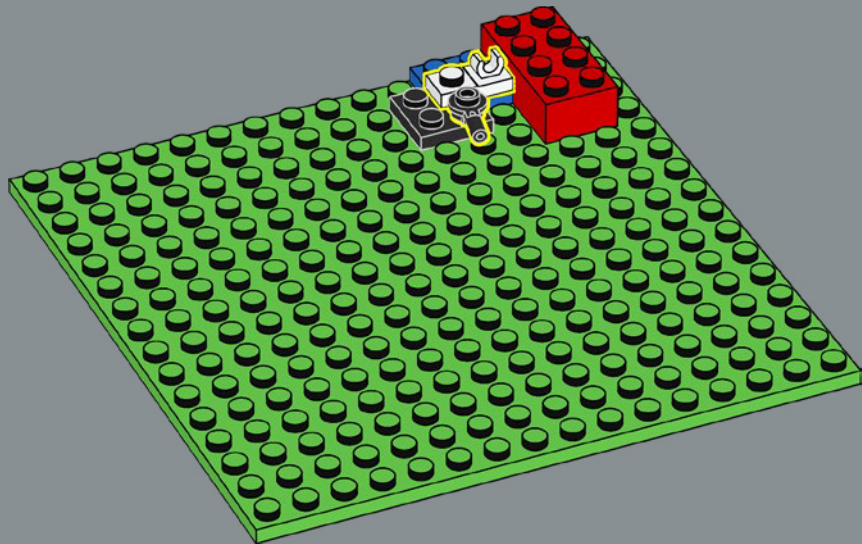

122

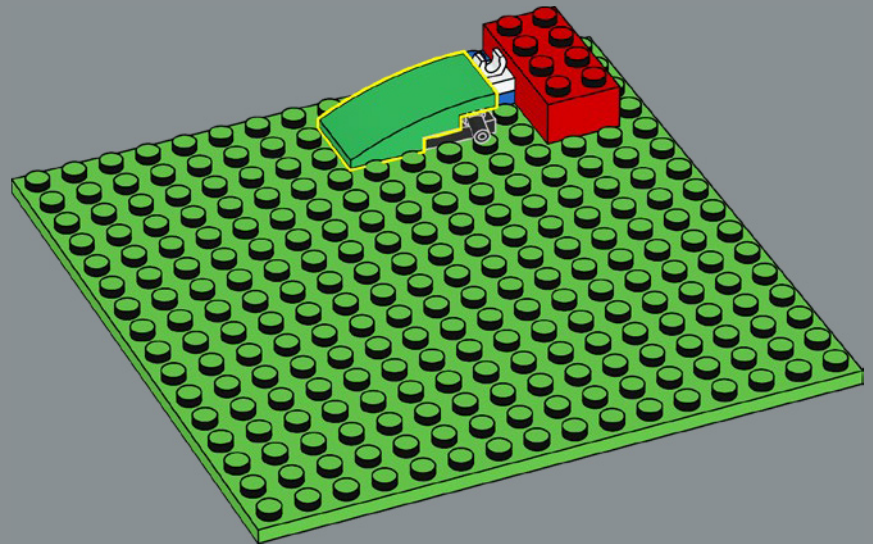



123

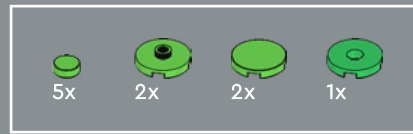
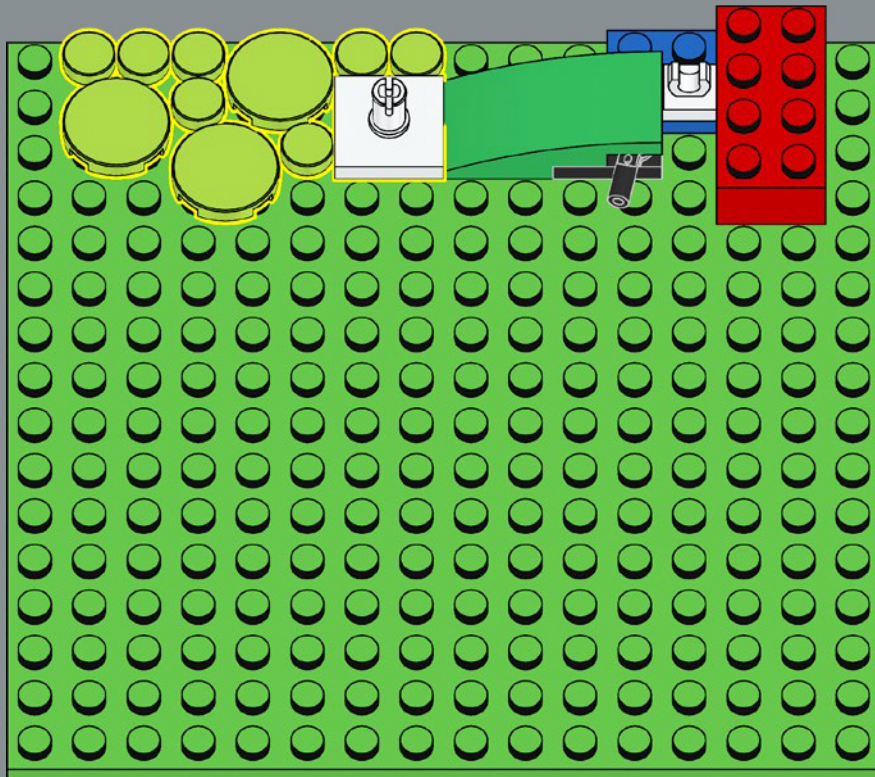

124

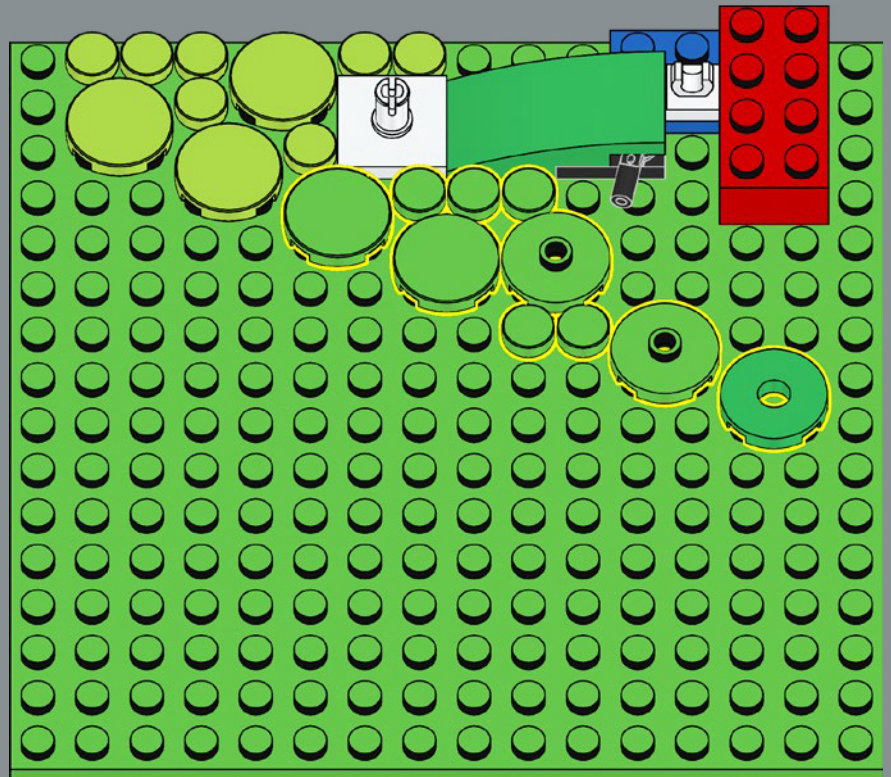



127

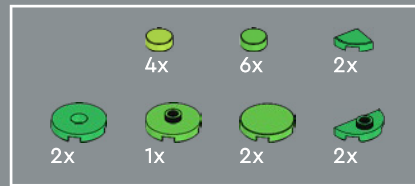
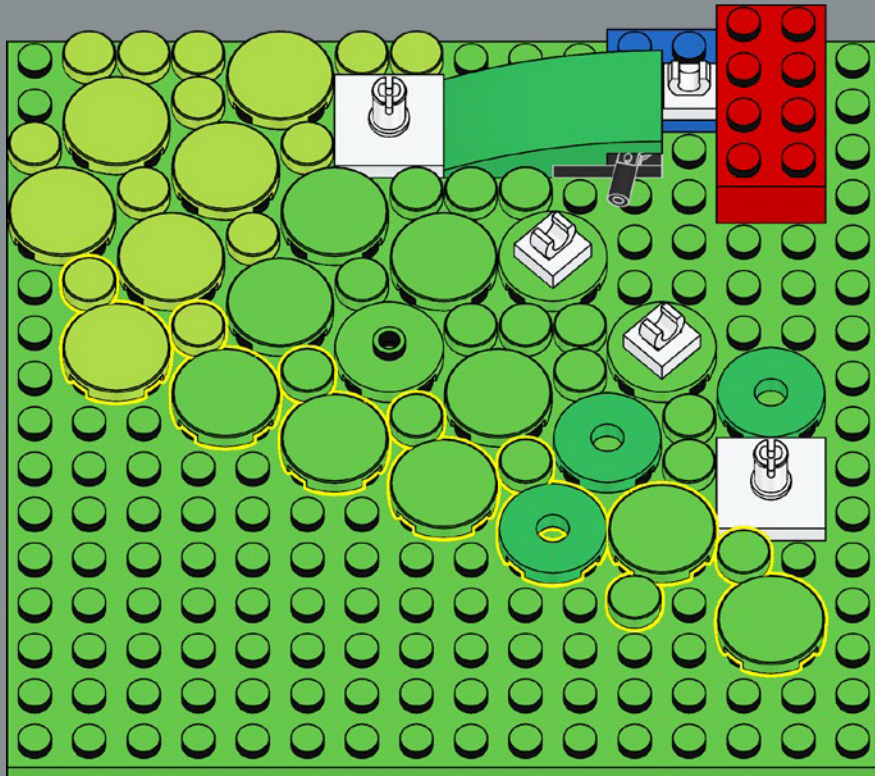

128

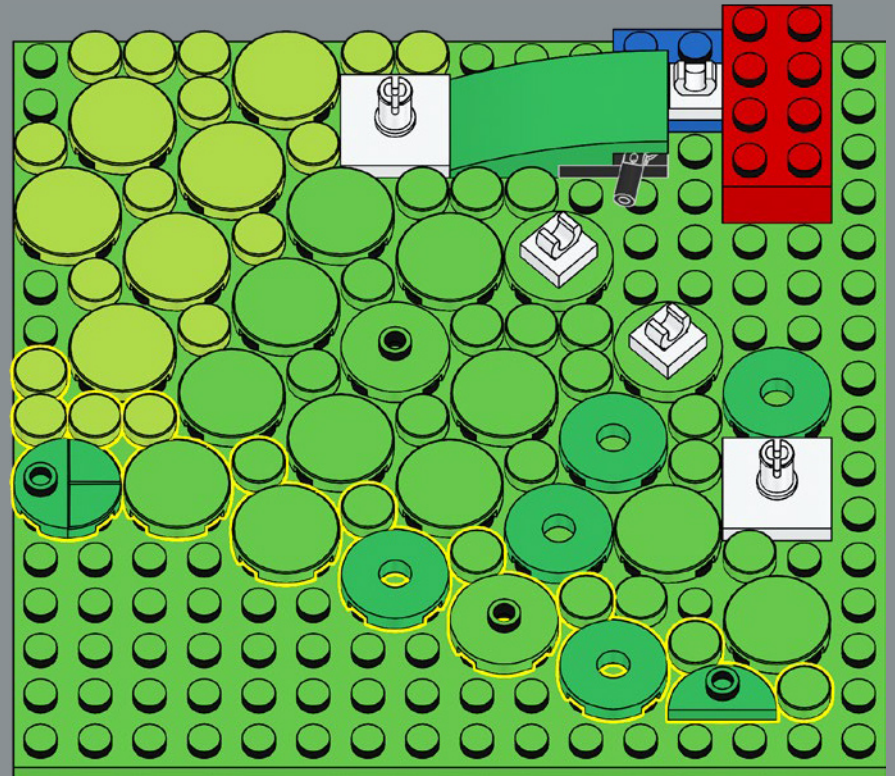

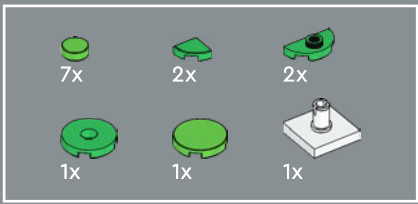

129

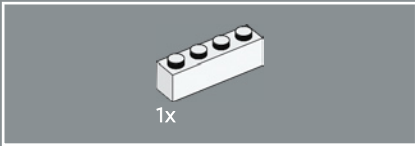
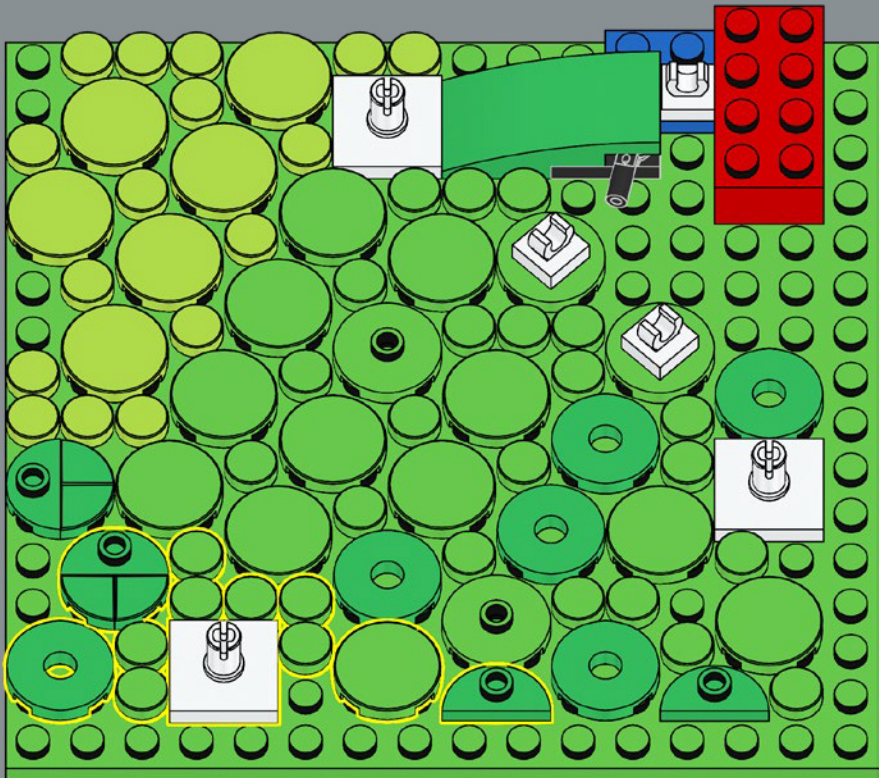

130

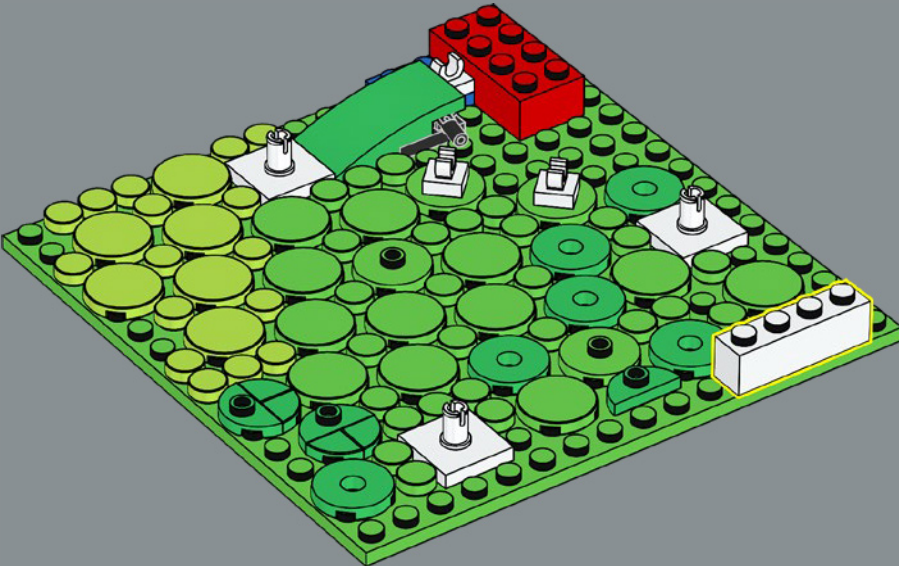

131

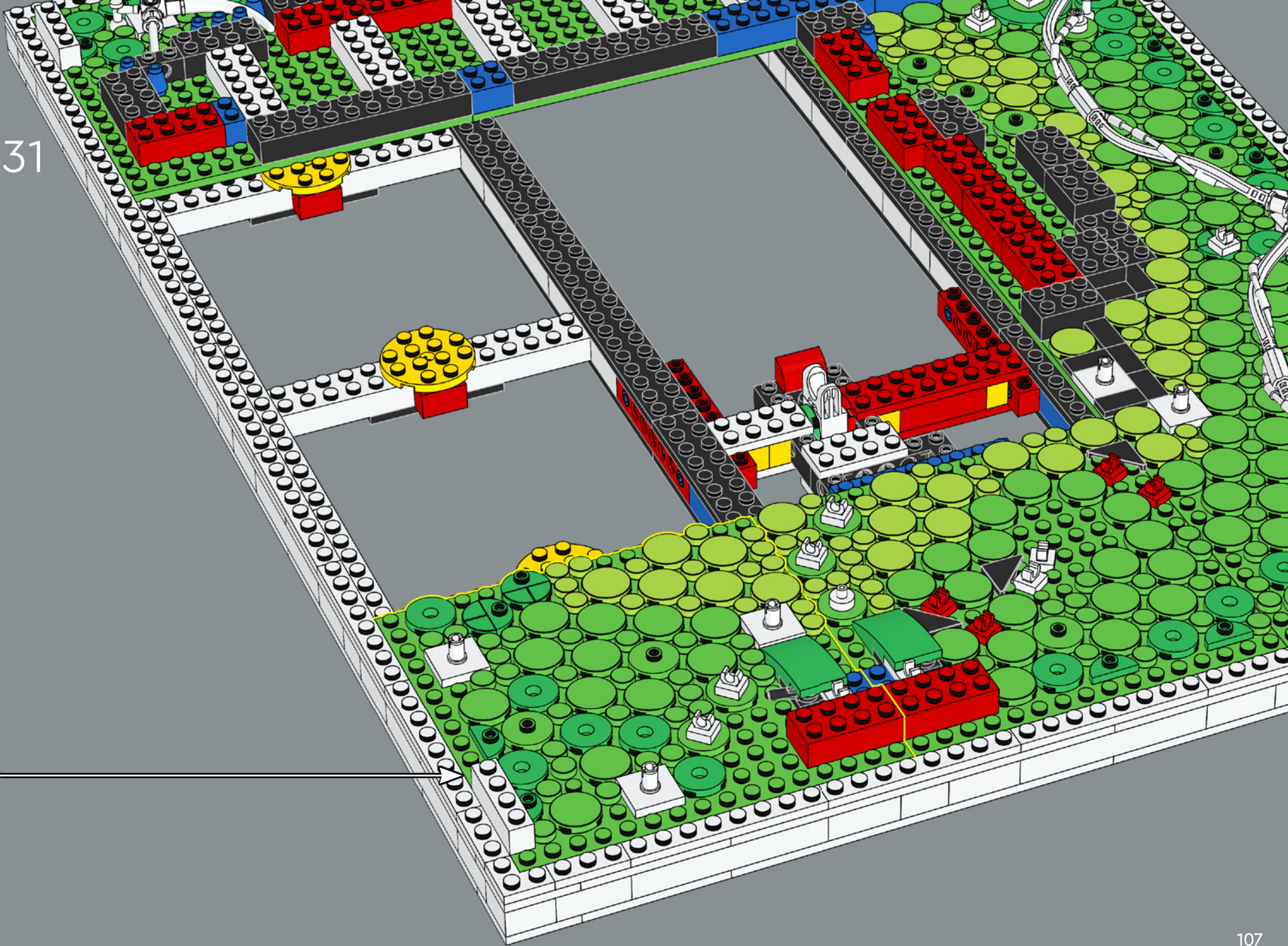

132

3x

3x

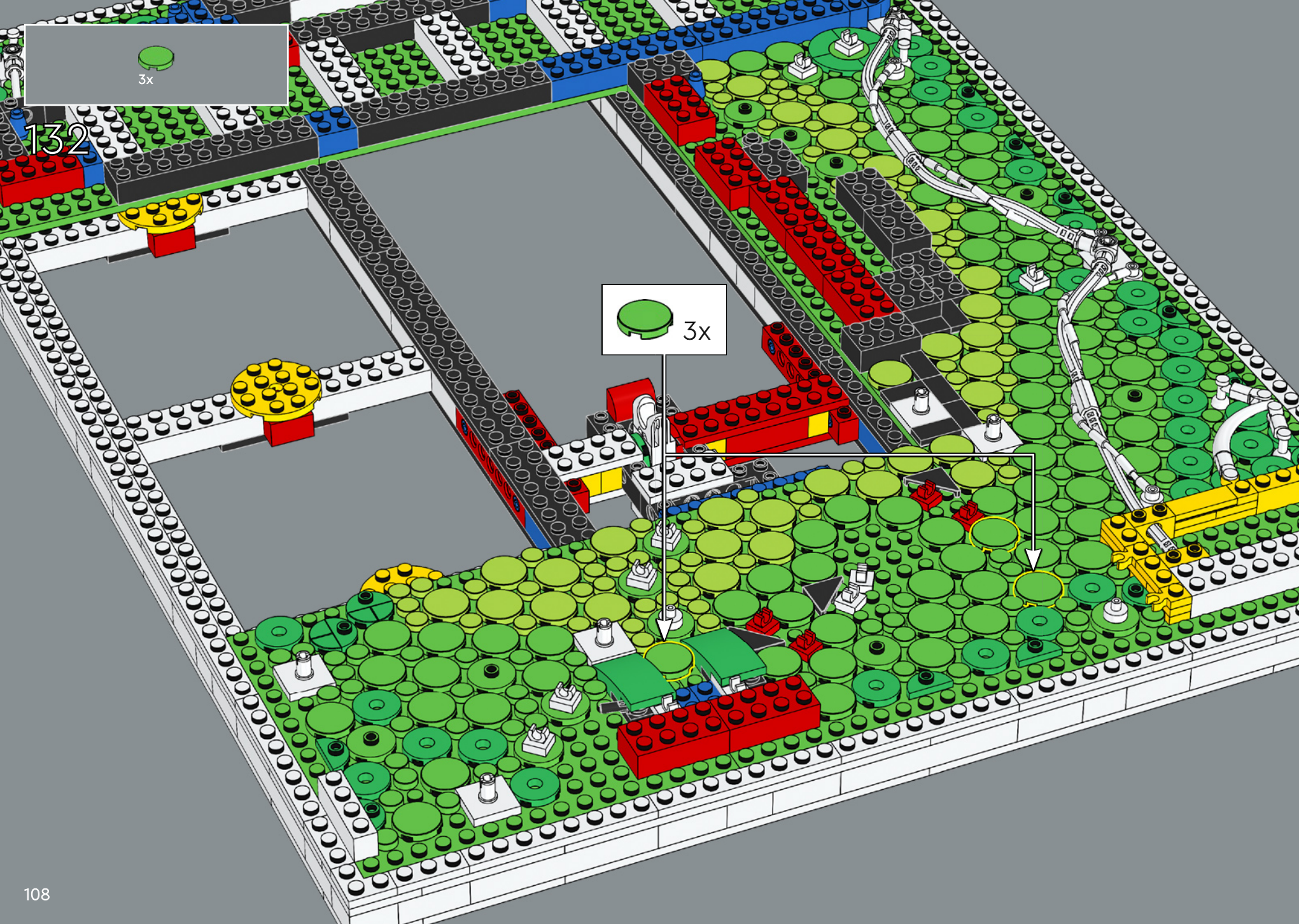

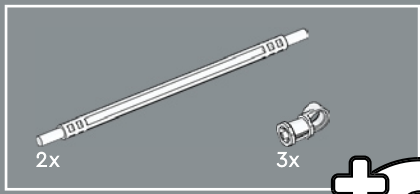

133

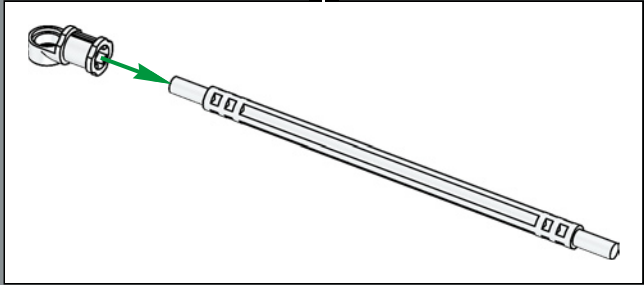
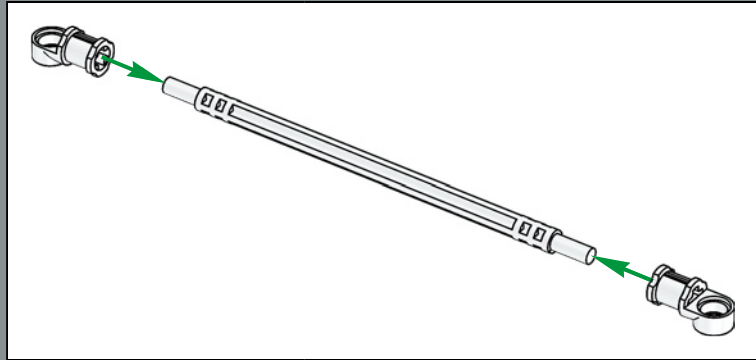
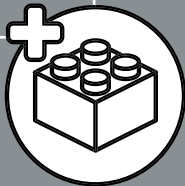

134

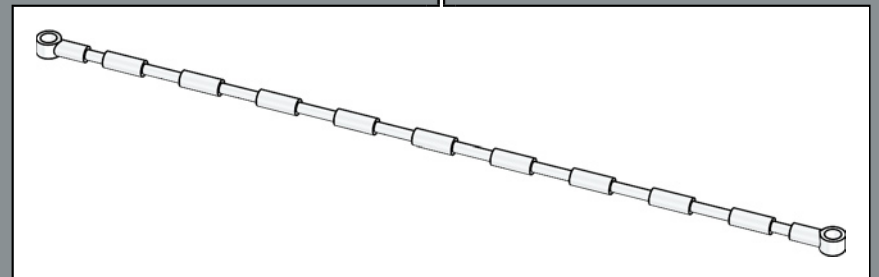
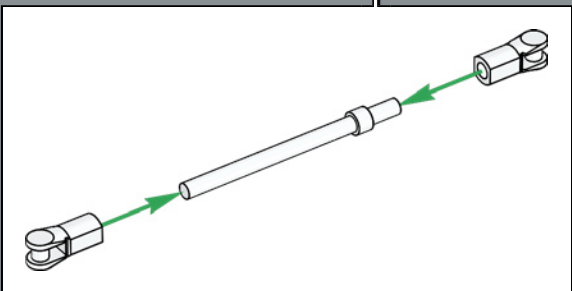
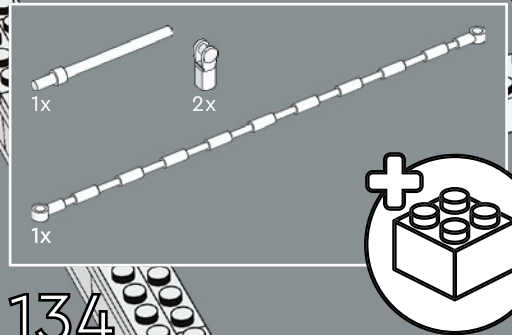

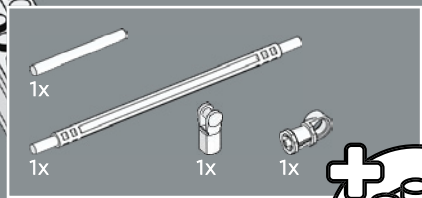

135

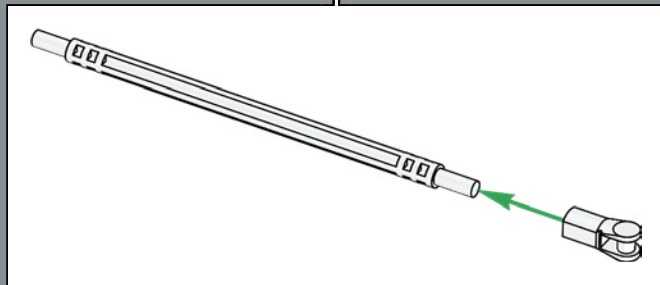
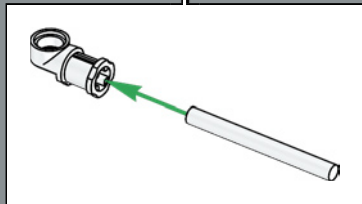
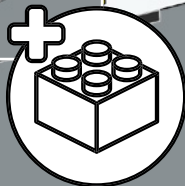

4x
1x

136

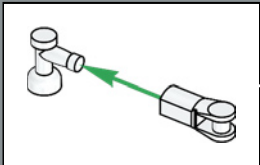

3x

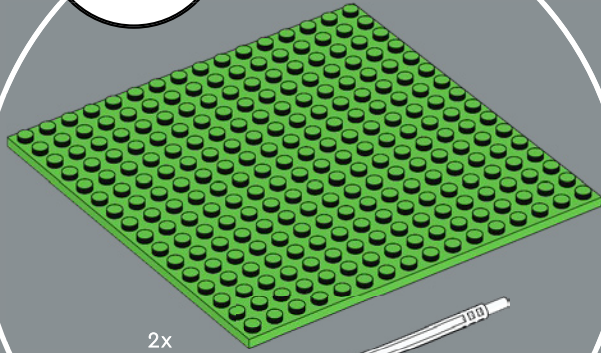
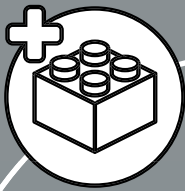

2x

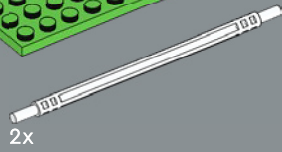

2x

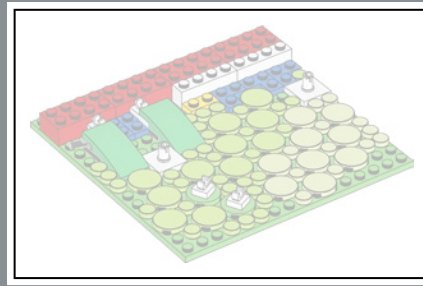

1x

137

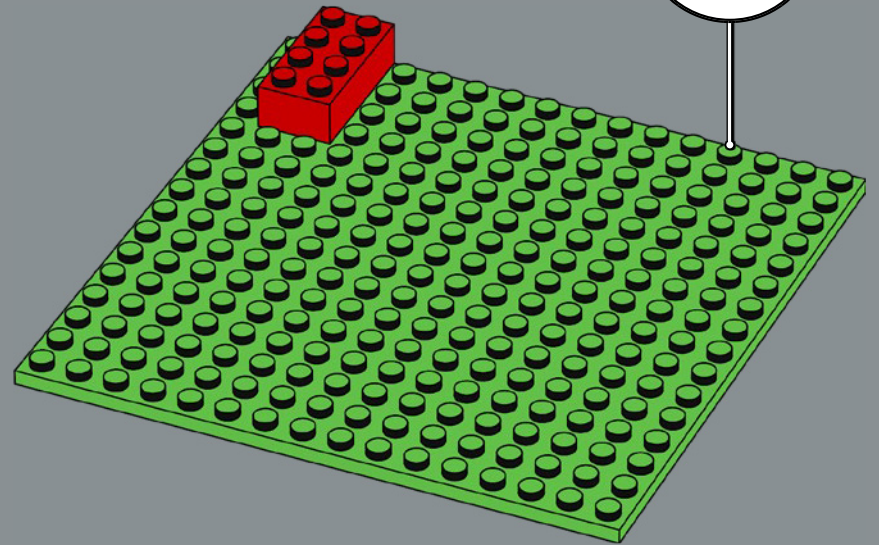
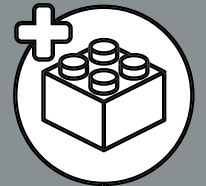

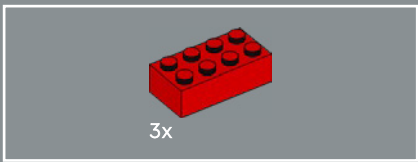

138

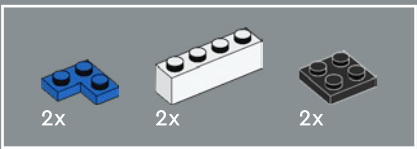
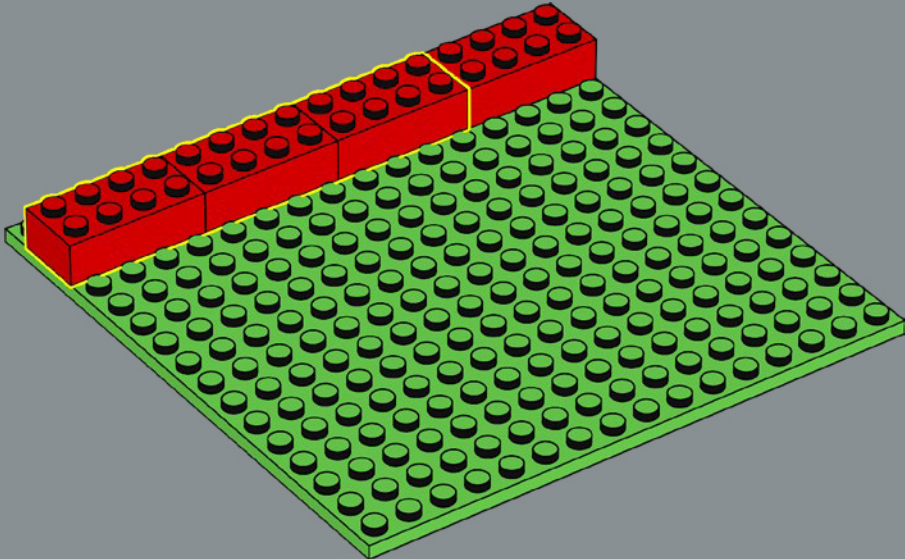

139

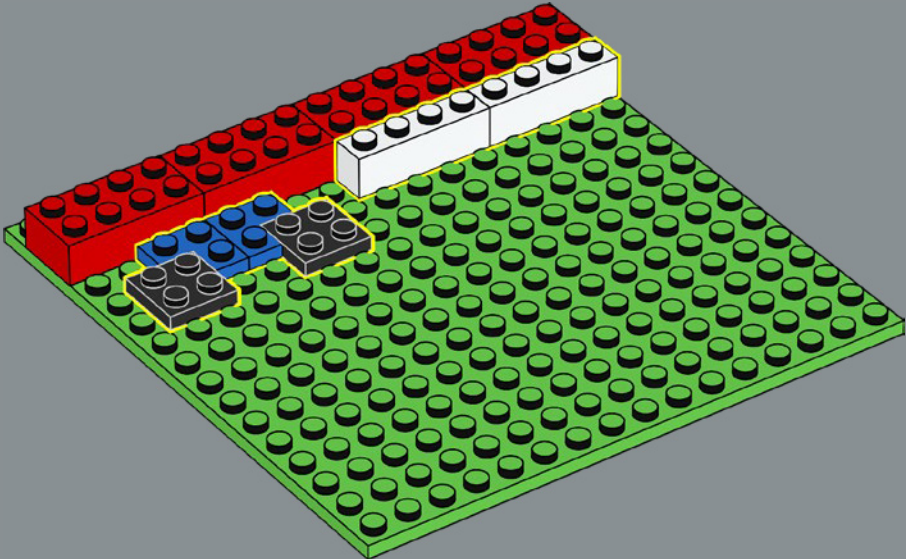



140

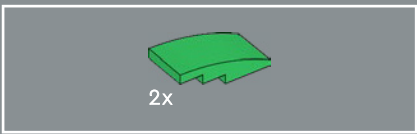
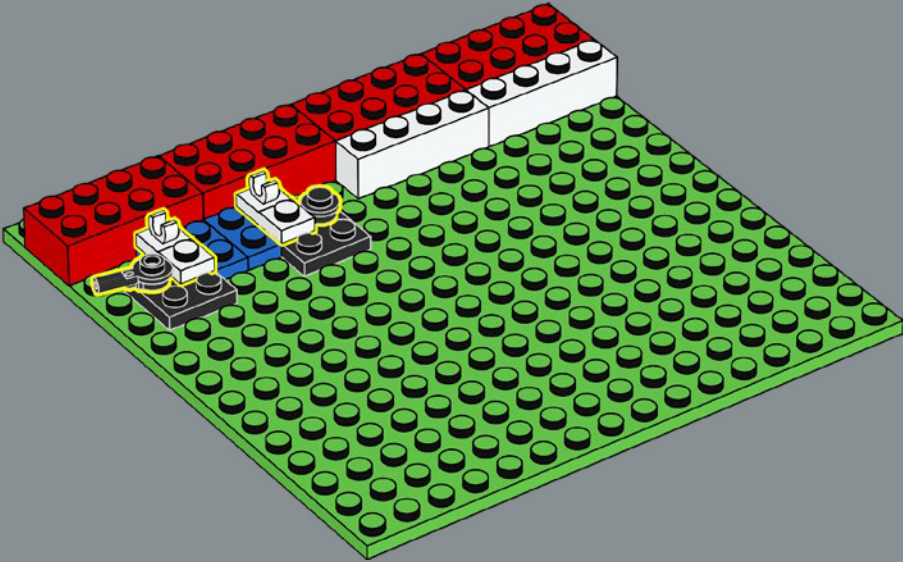

141

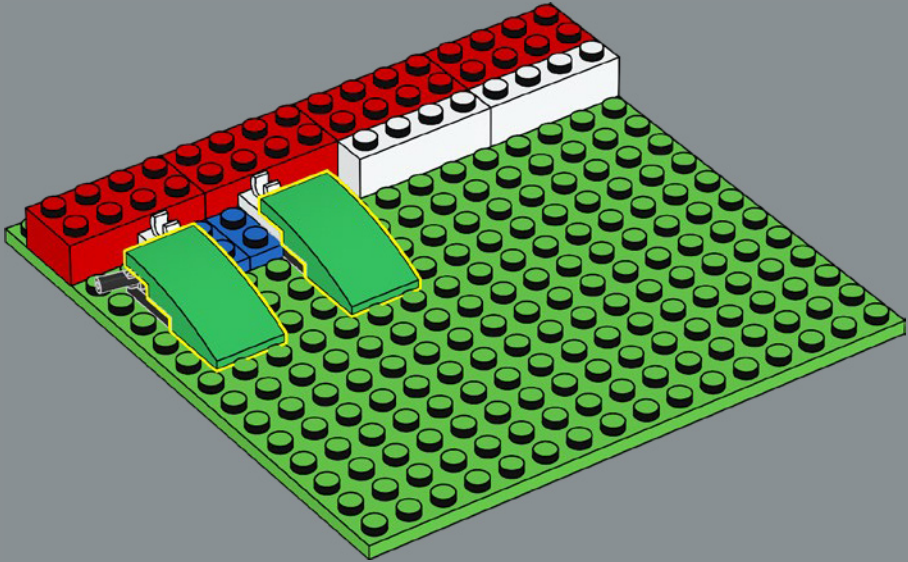

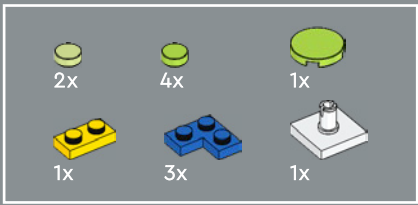

142

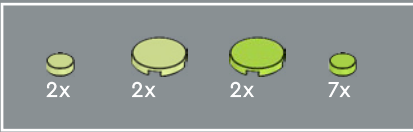
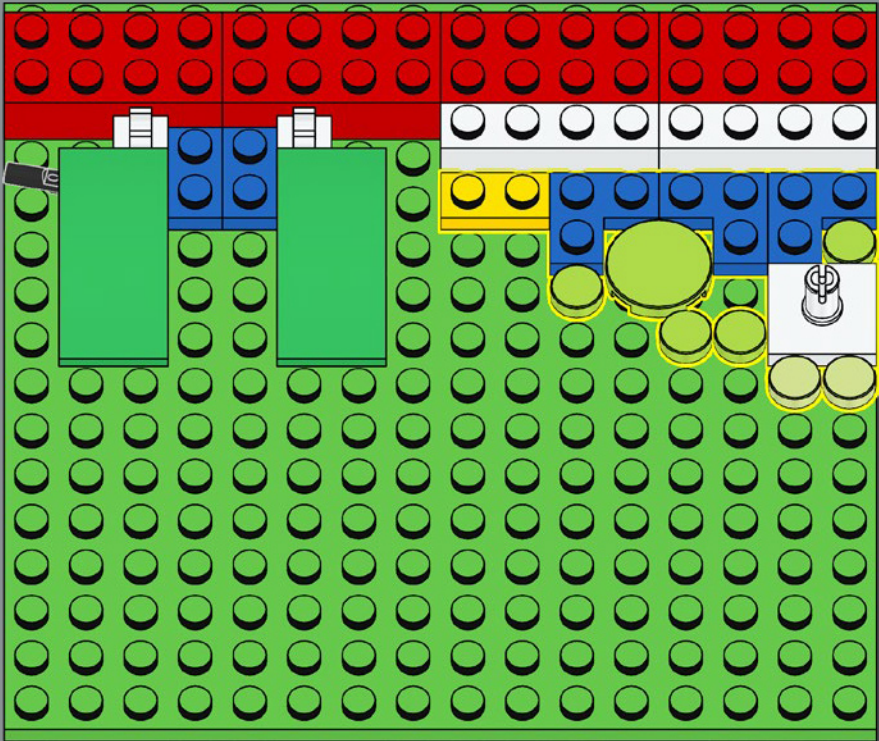

143

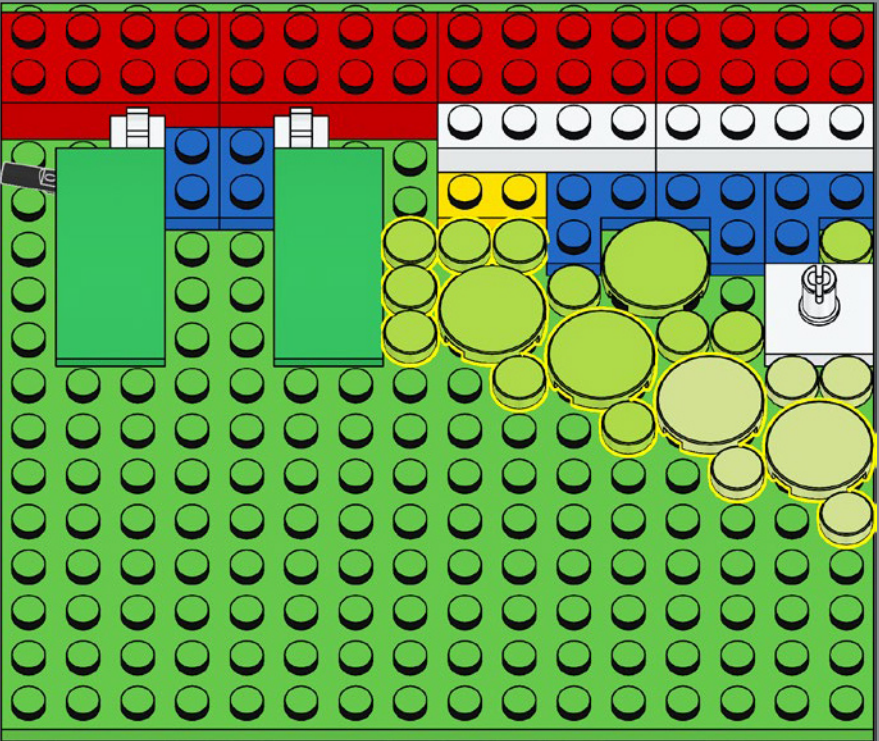

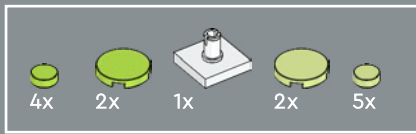

144

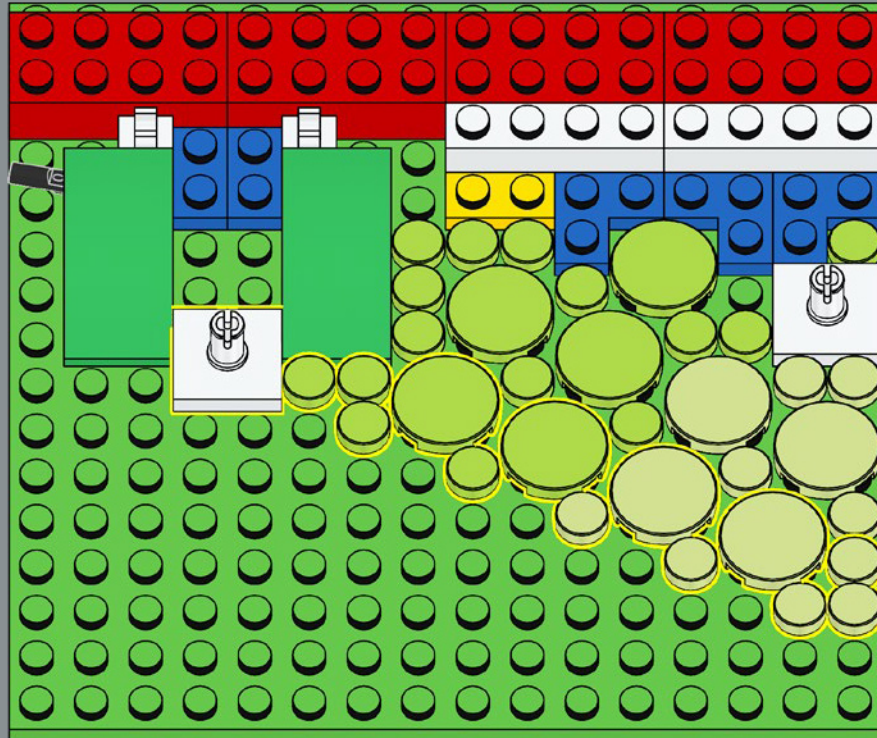

145

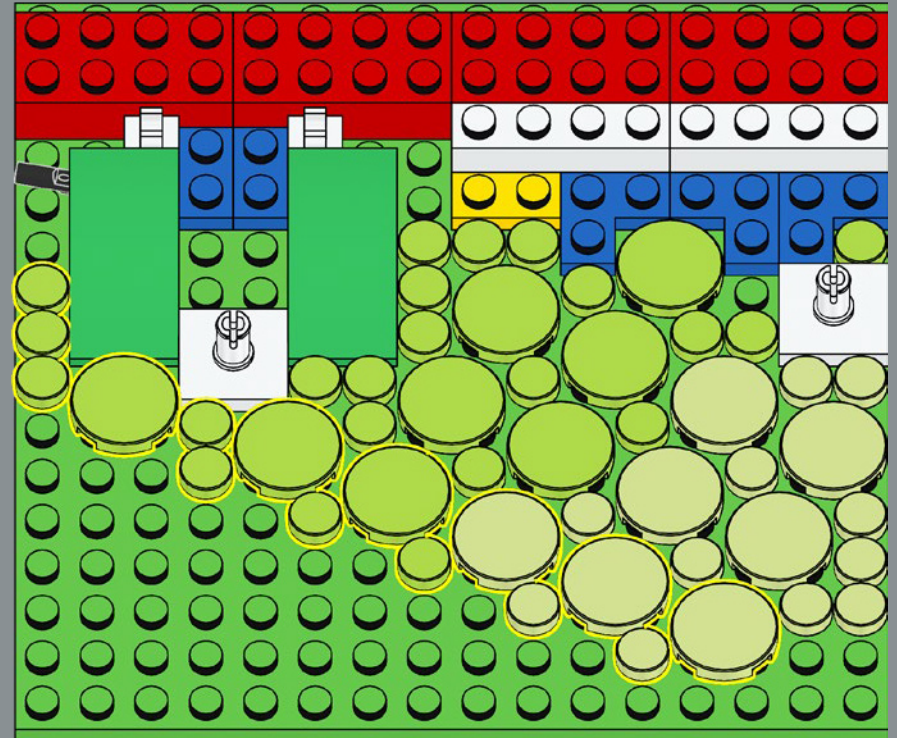



146

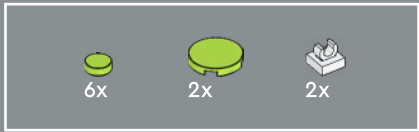
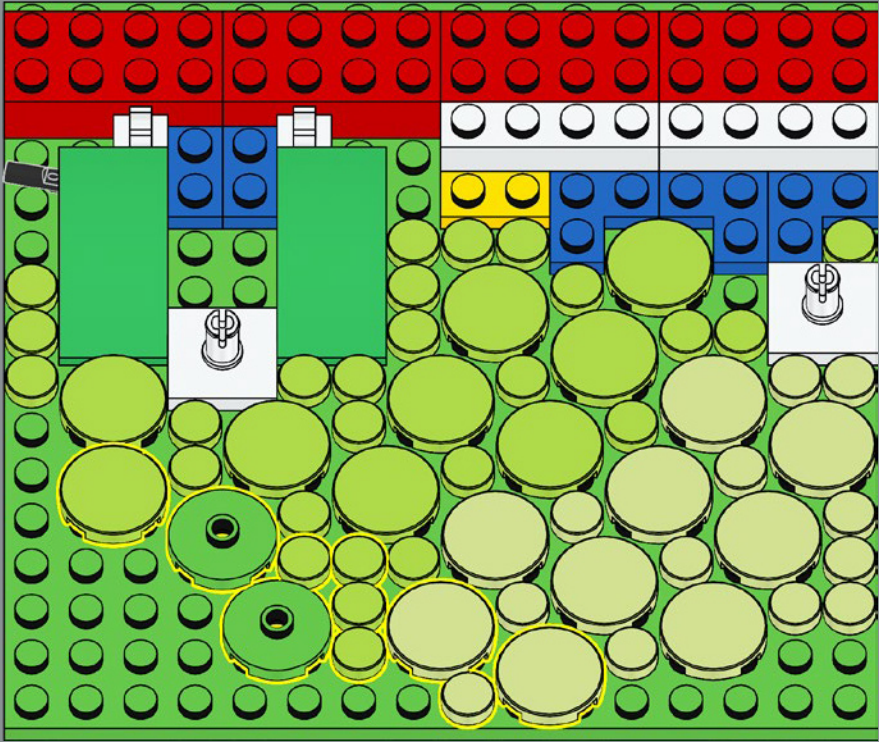

147

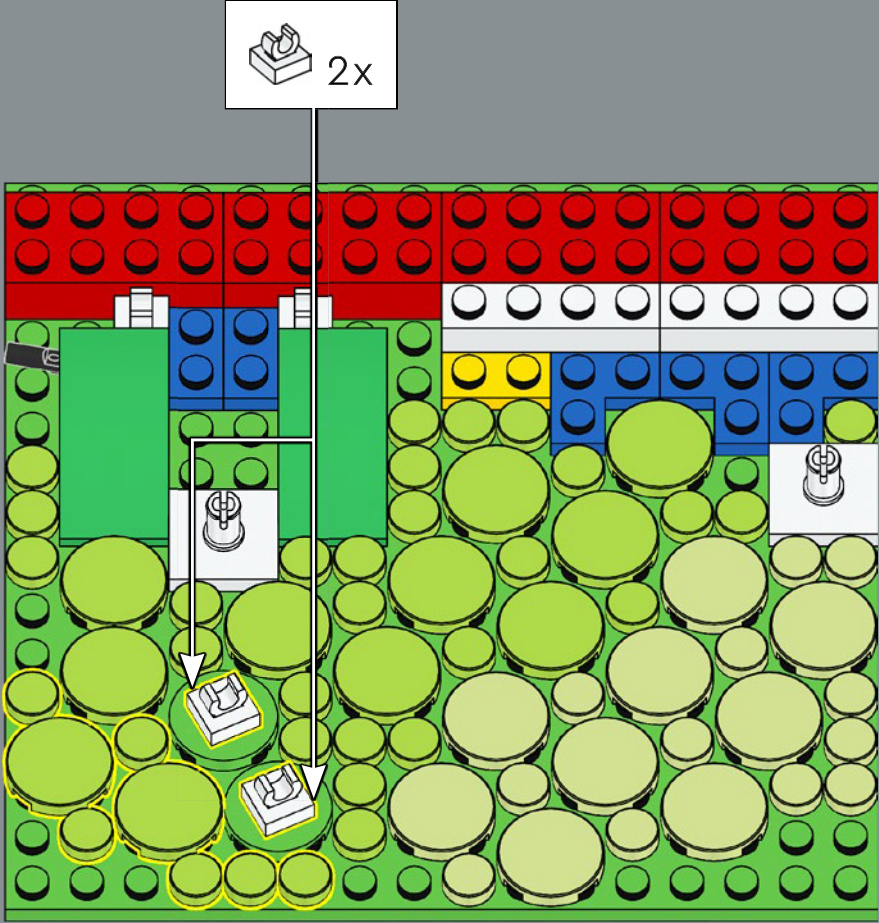

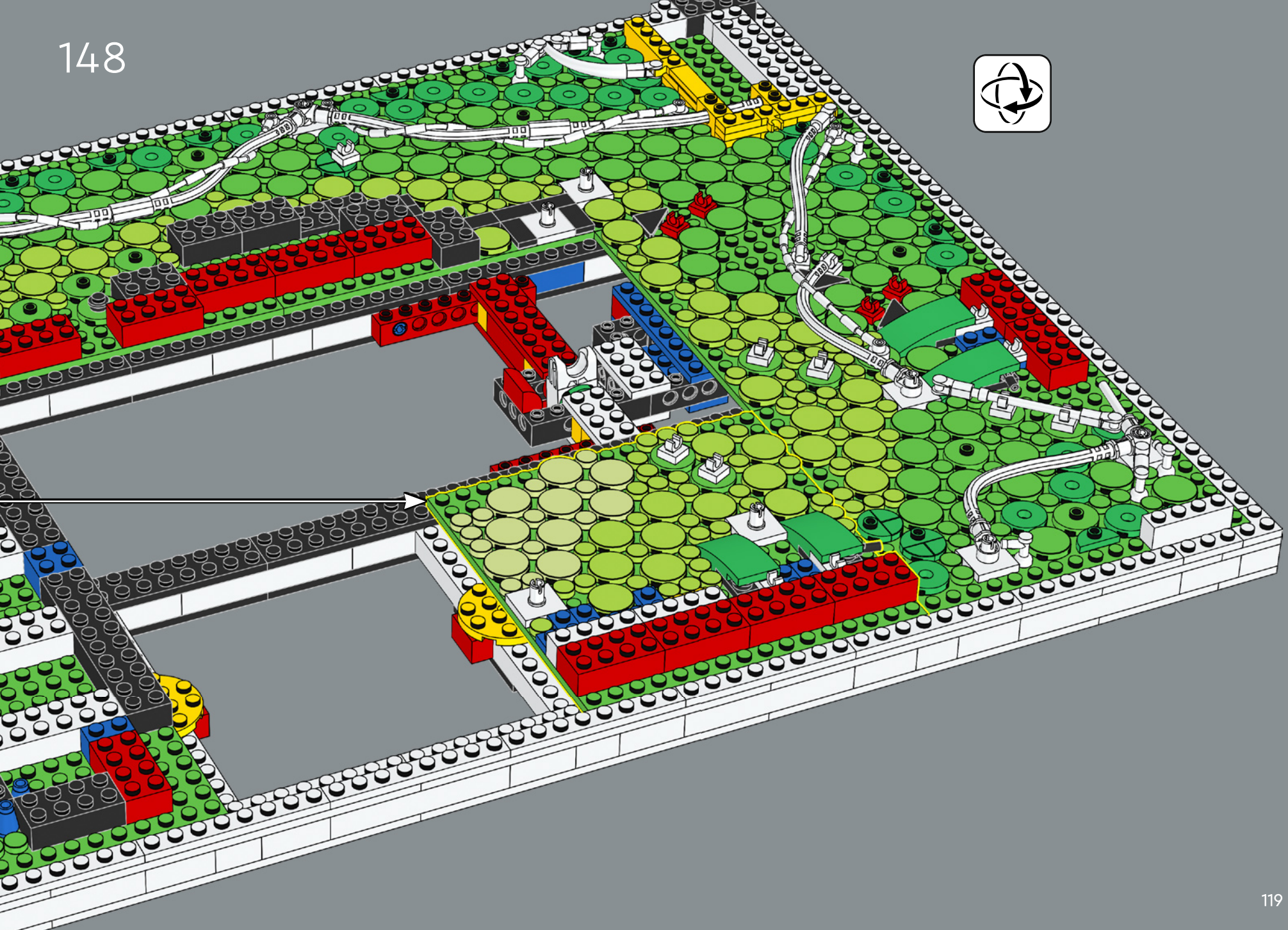

2x

149

2x

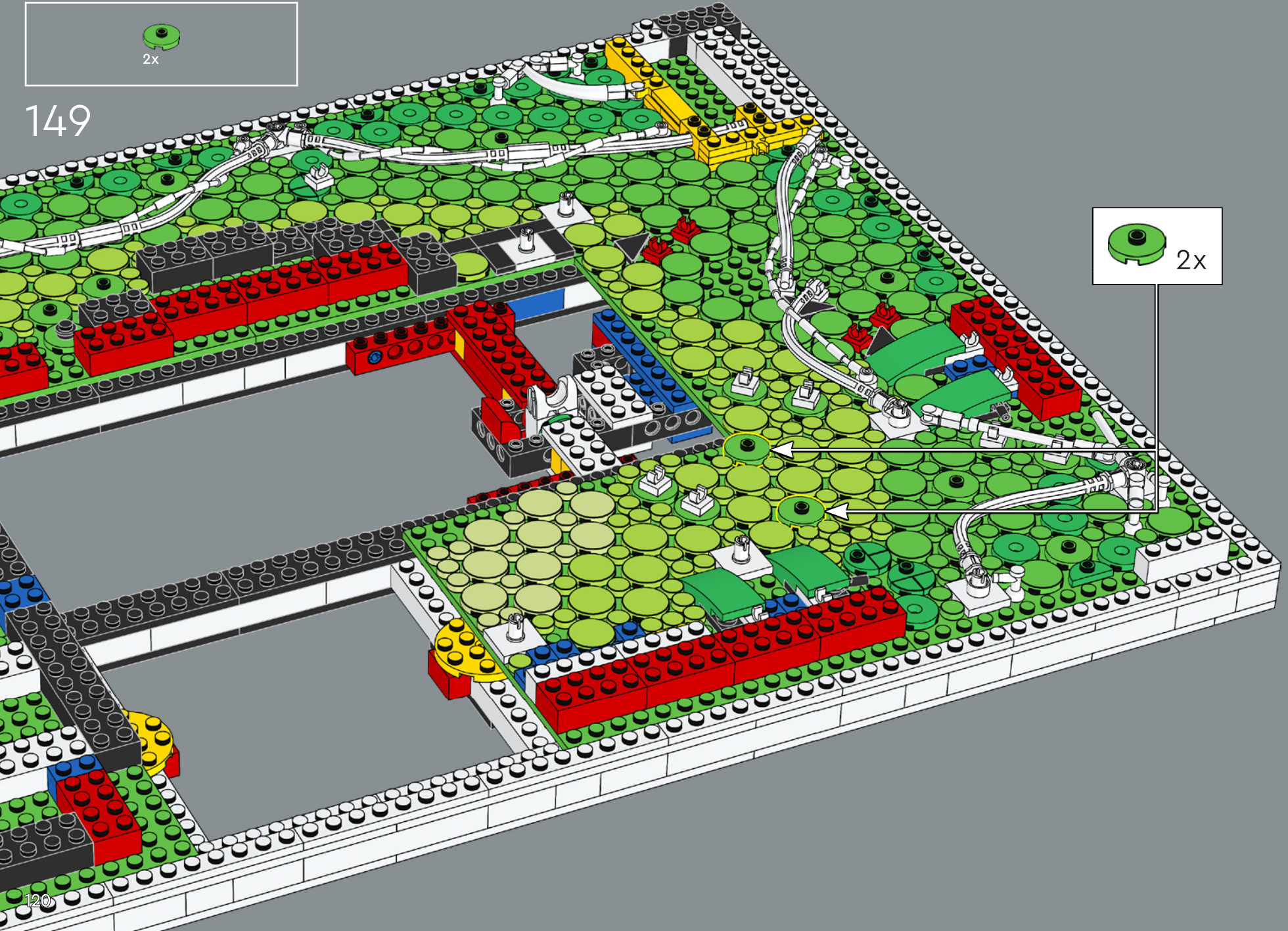

120

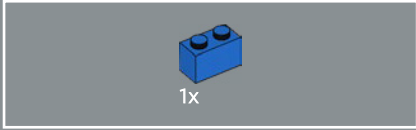
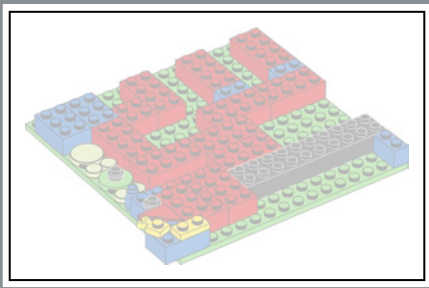

150

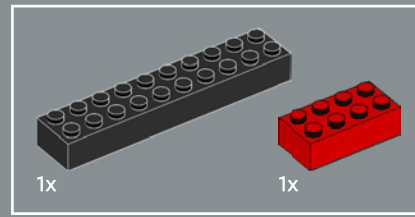
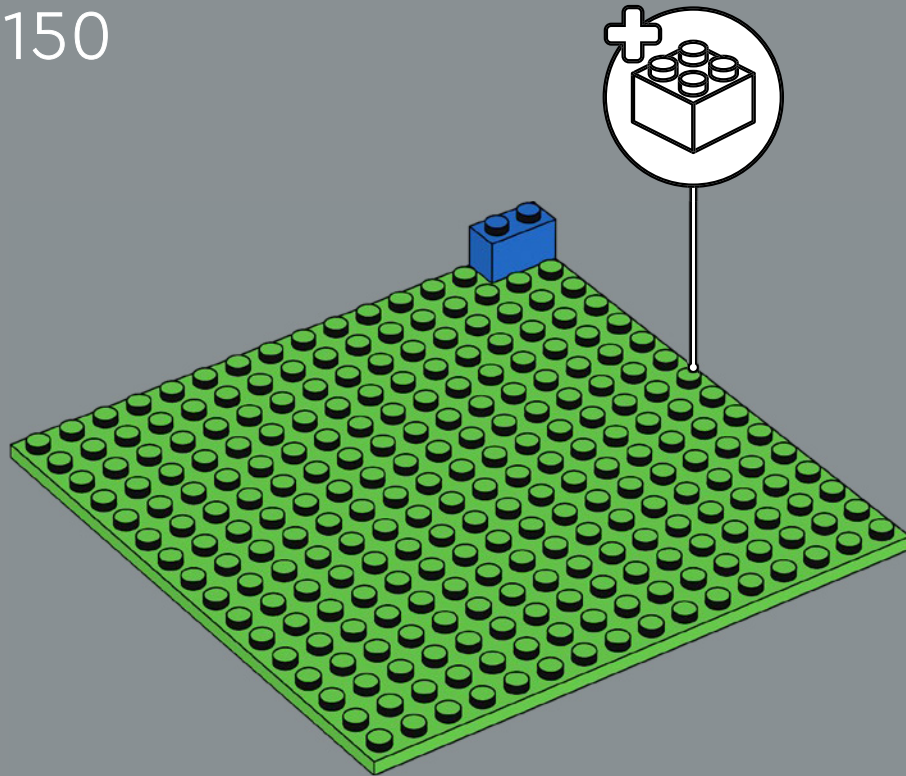

151

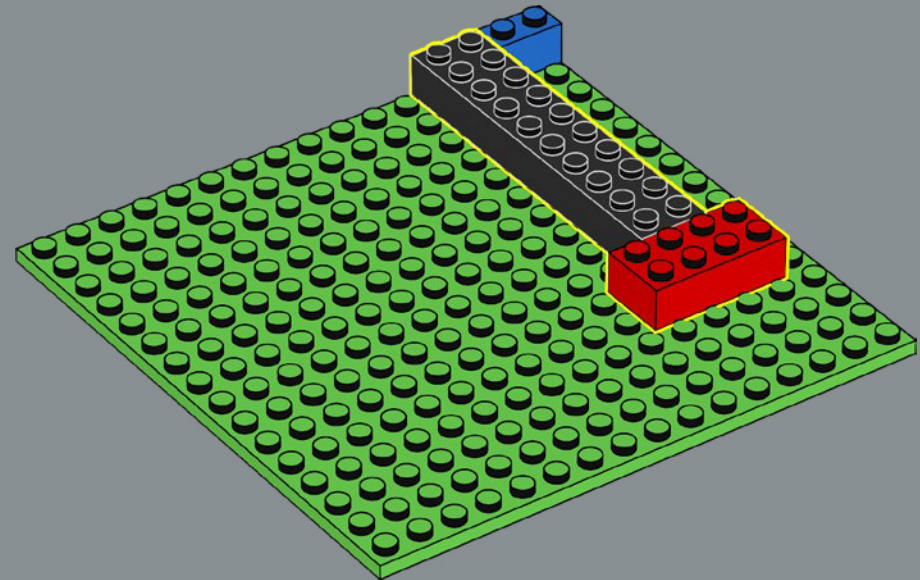

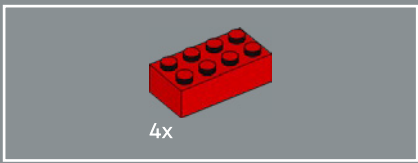

152

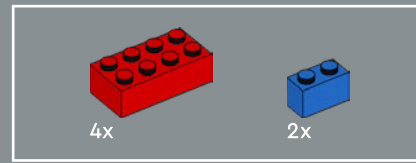
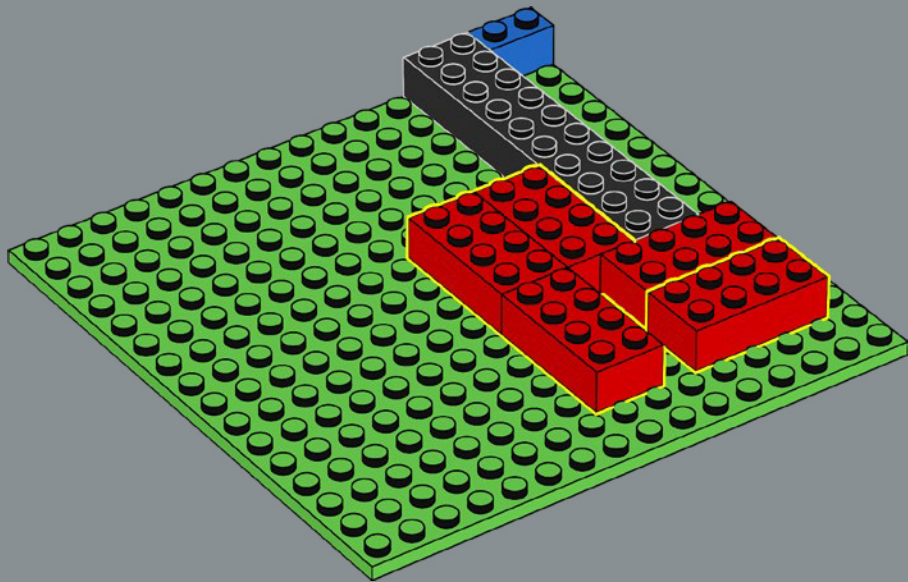

153

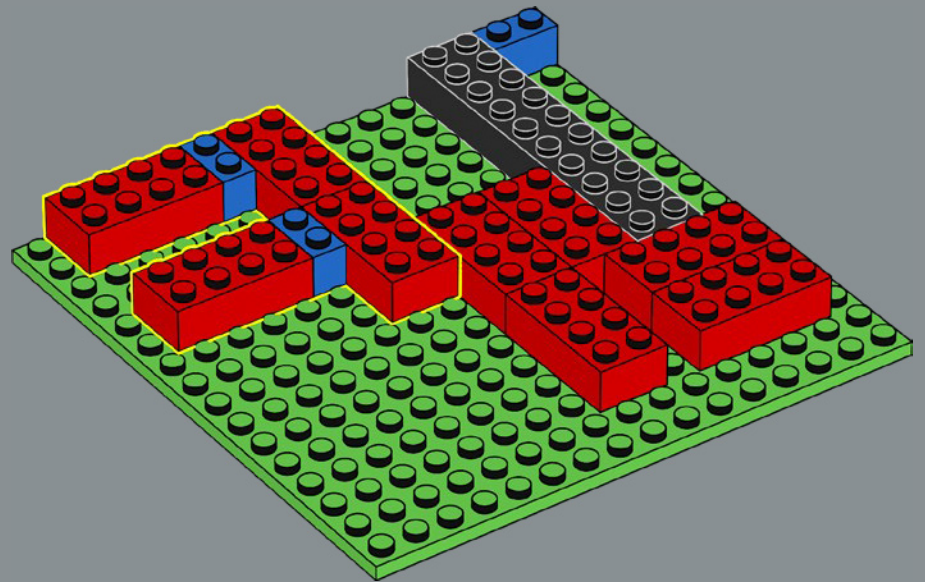

Did you know that the 10294 LEGO® Titanic contains a record amount (40) of iconic red 2x4 bricks? So far, you have placed 35 ...

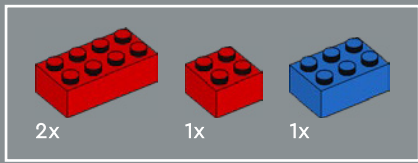

154

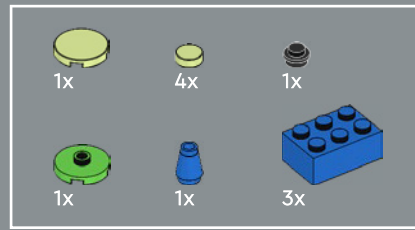
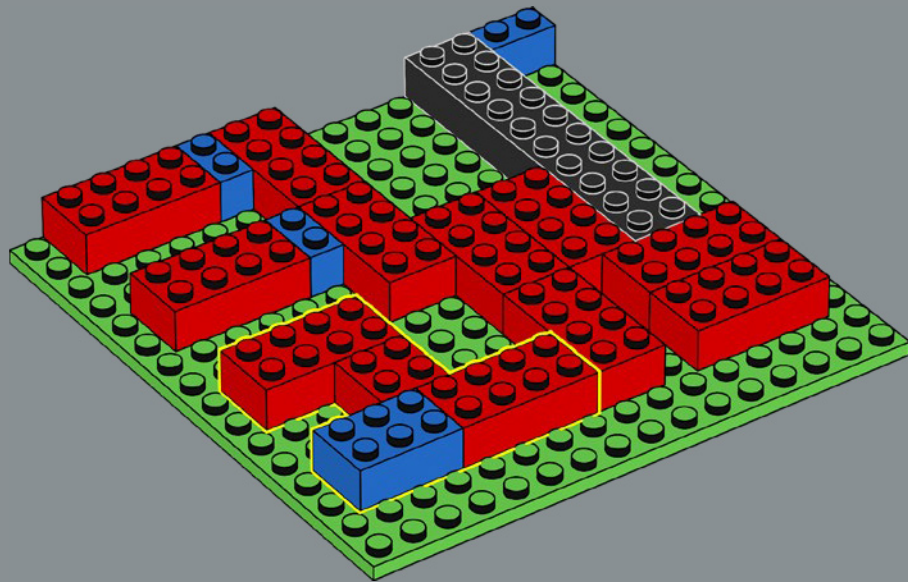

155

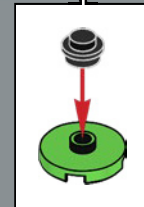
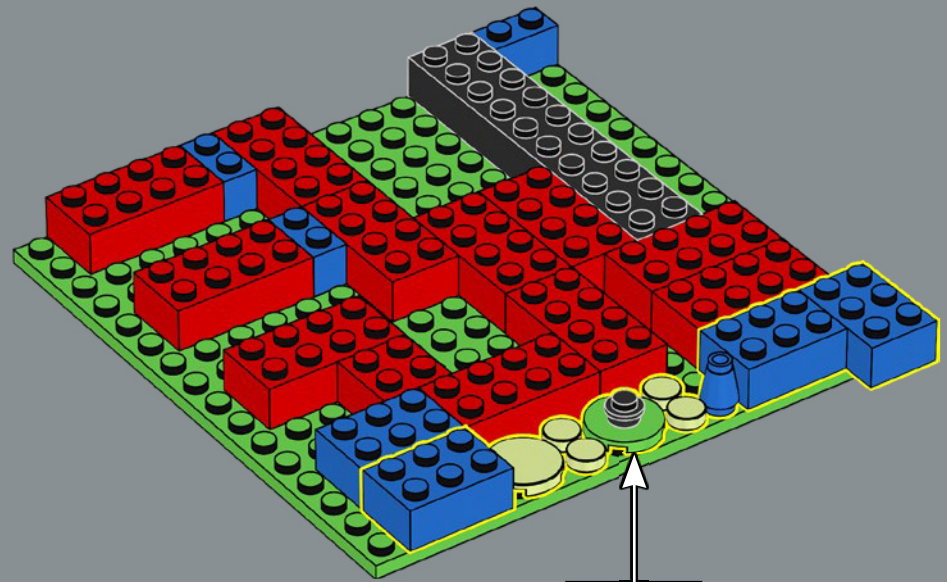

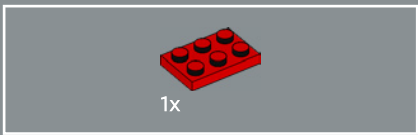

156

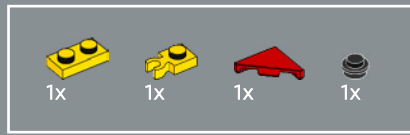
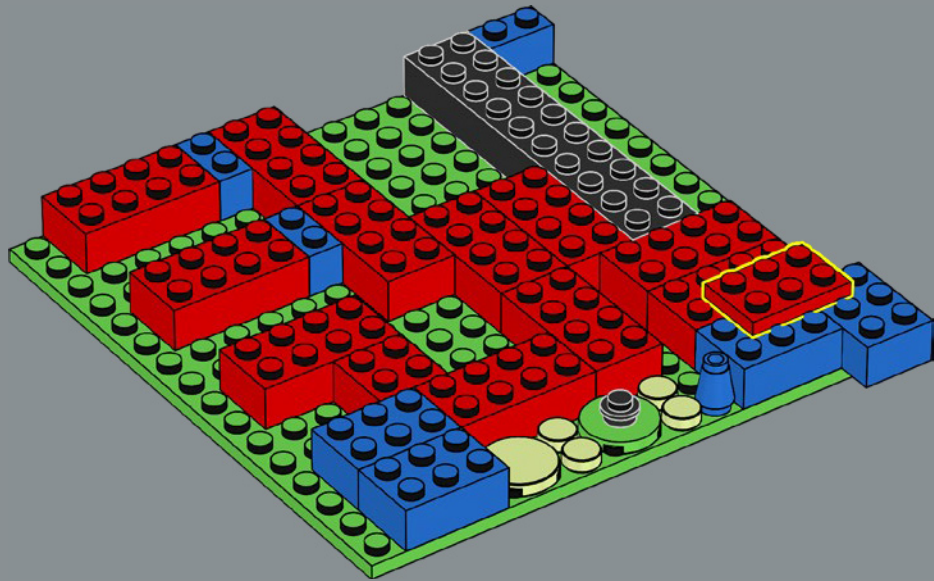

157

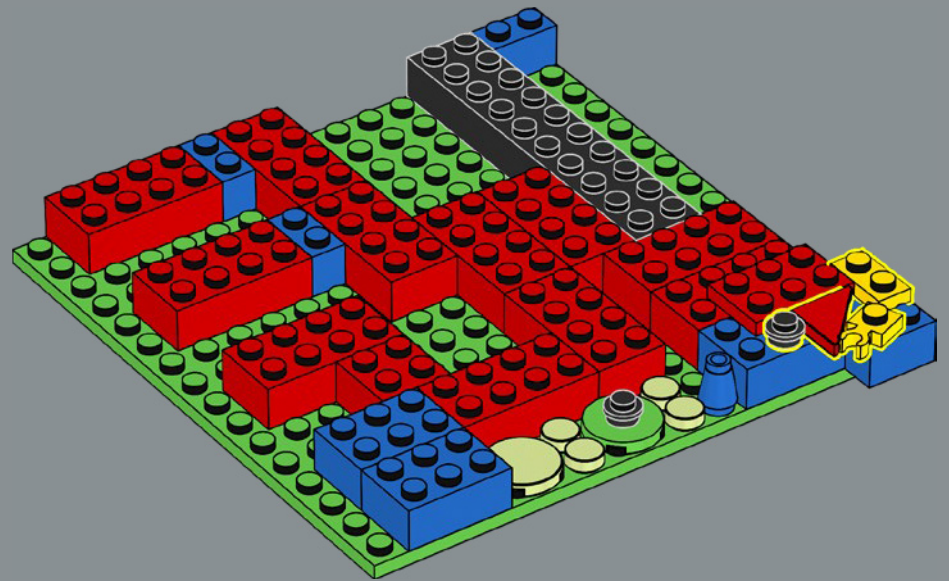

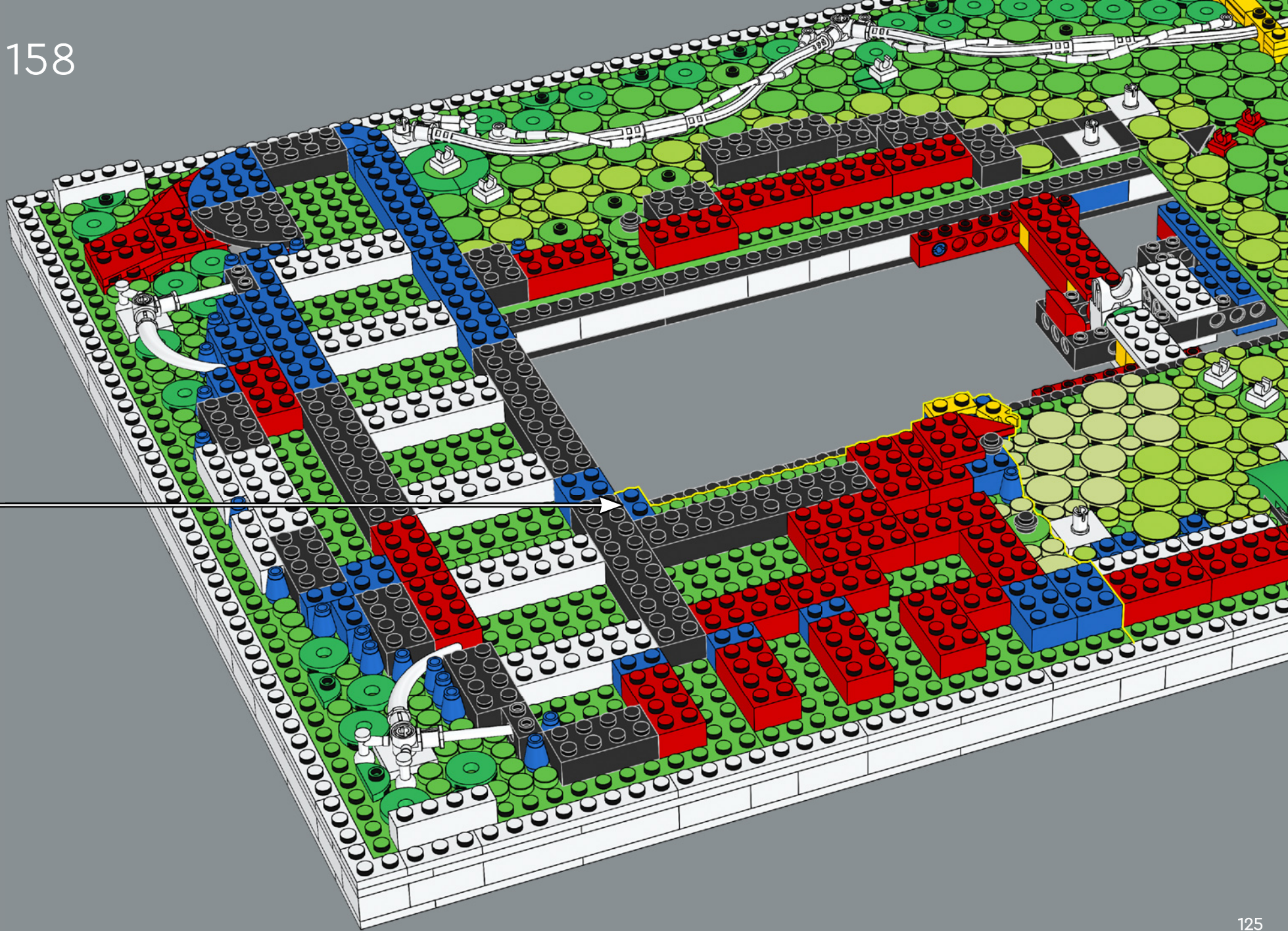

159

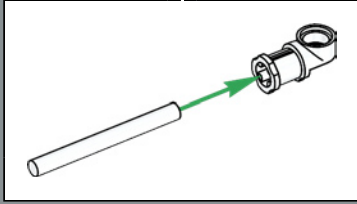
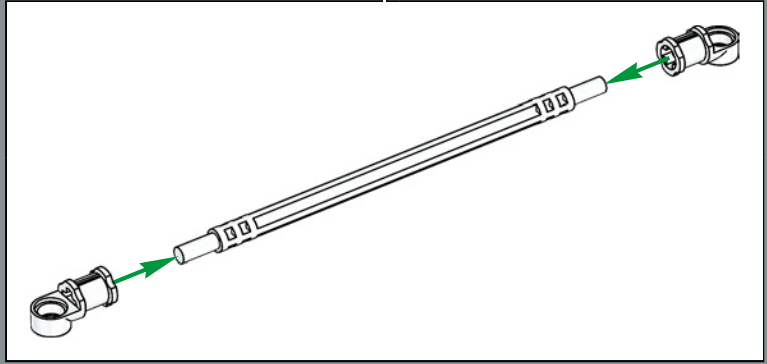
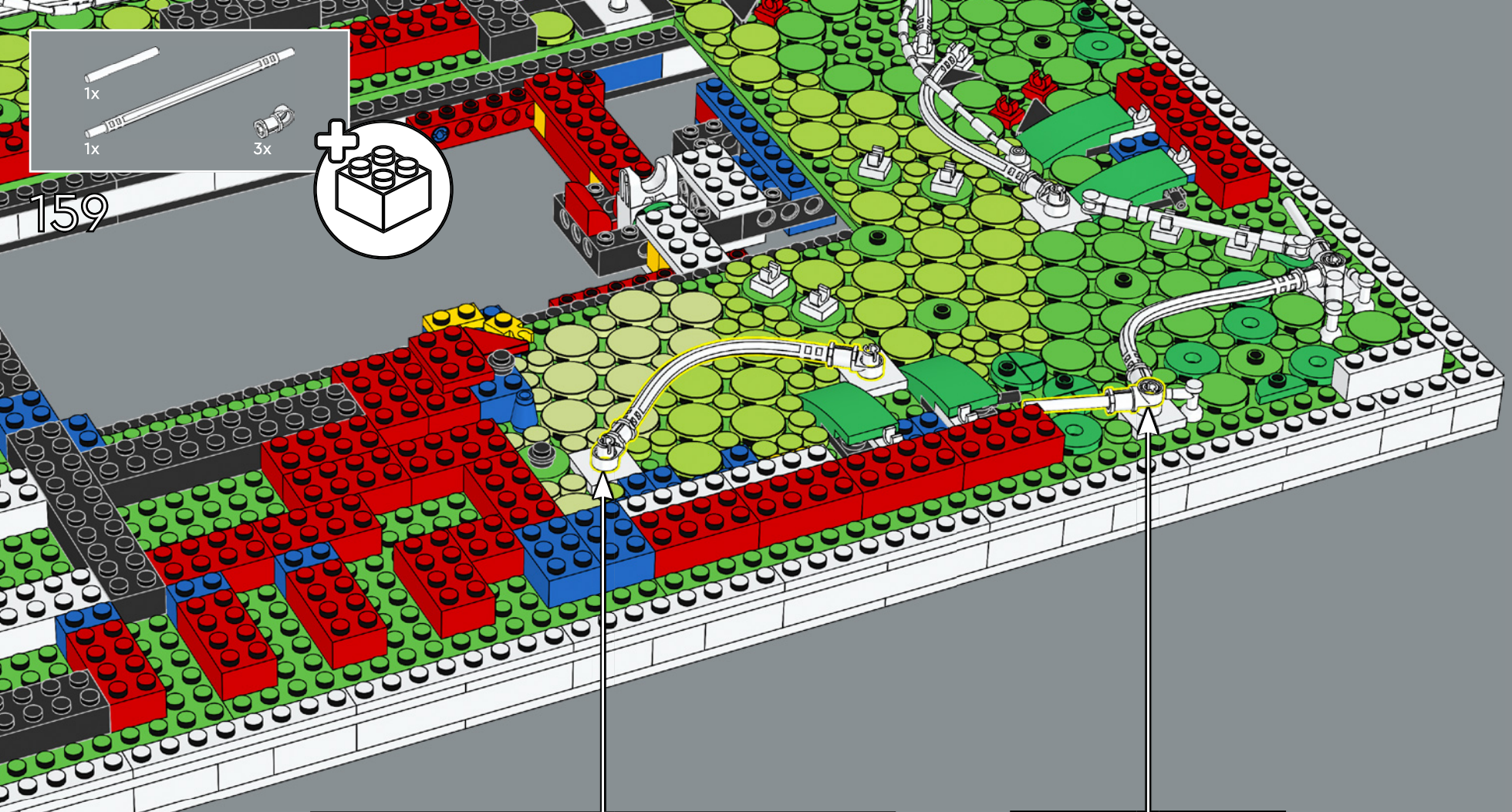
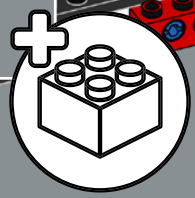

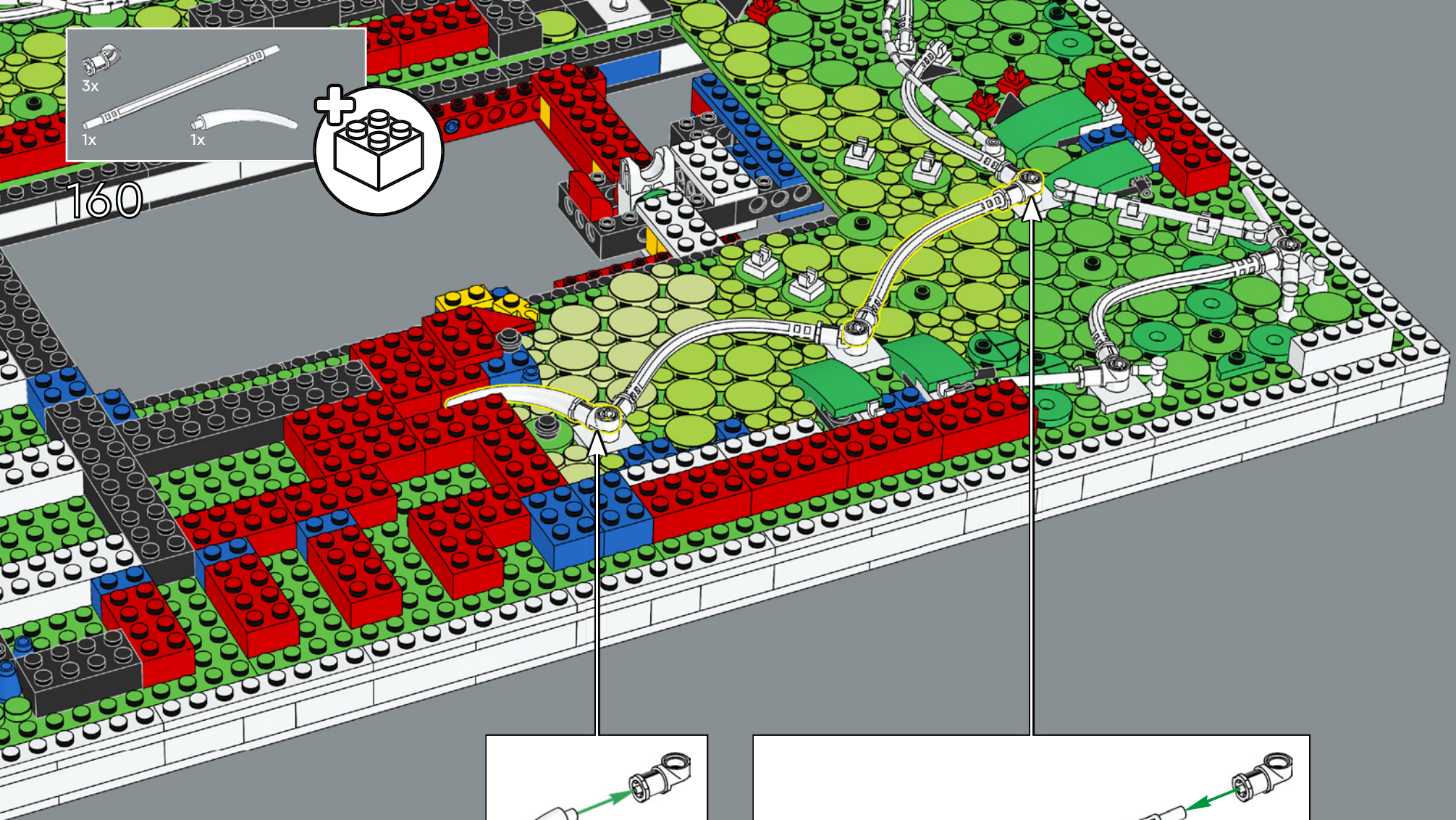

160

- 3x
- 1x
- 1x

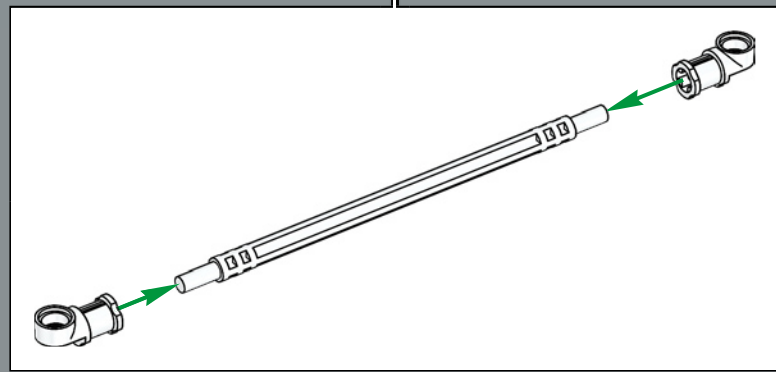
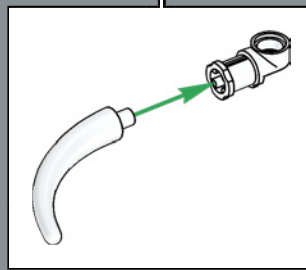
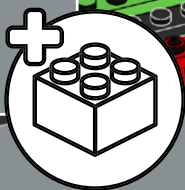

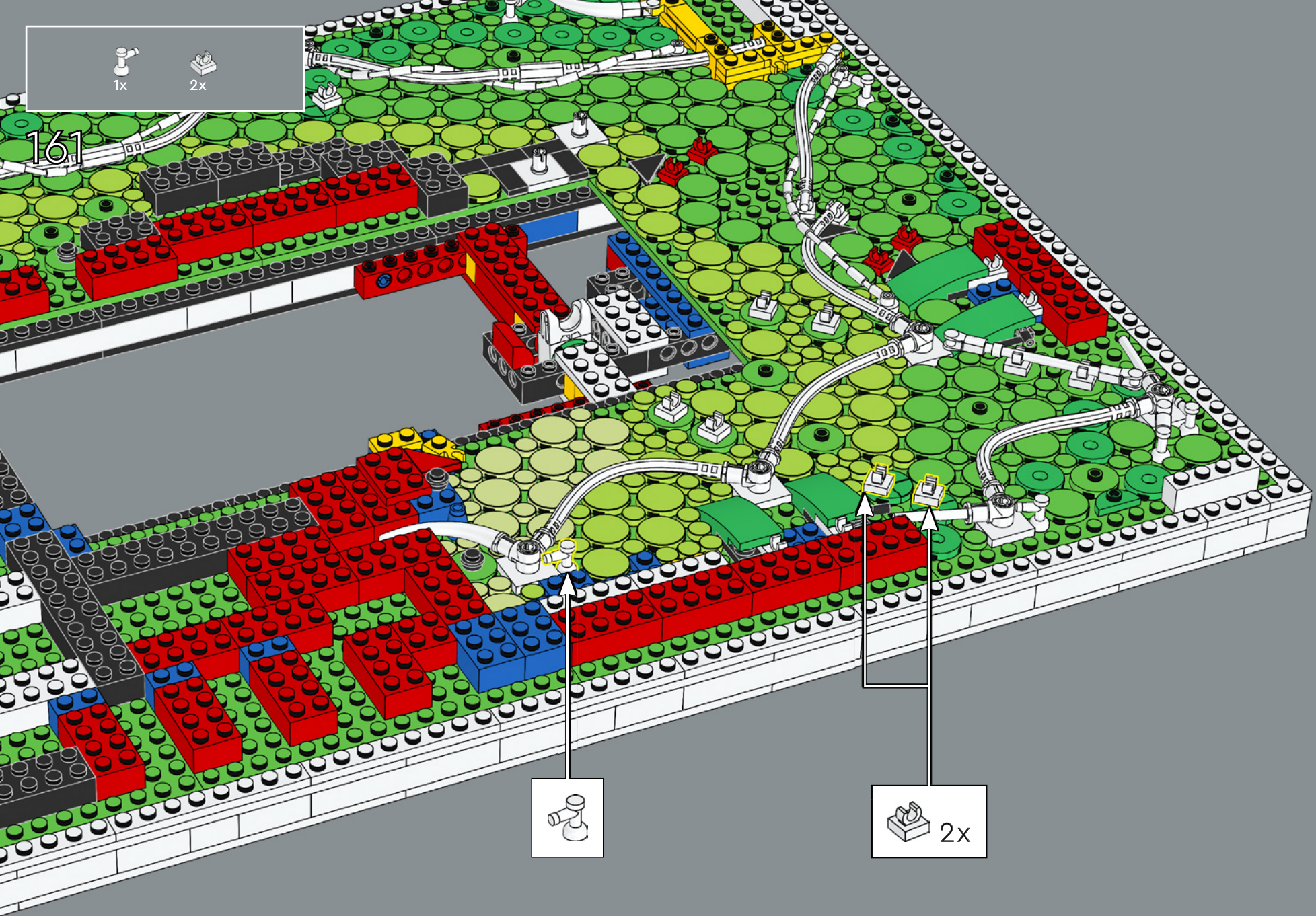

1x  2x 

161





 2x

-  1x
-  1x
-  2x

162

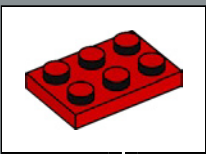

The tensile strength of Spider-Man's web lines has been estimated at around 120 pounds per square millimetre of the cross-section.

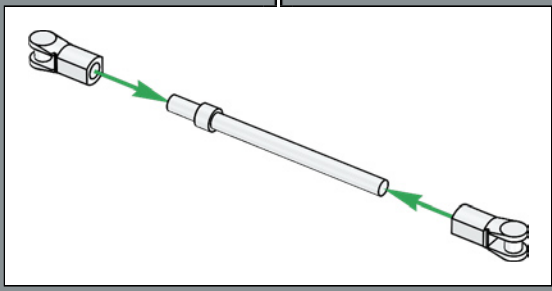

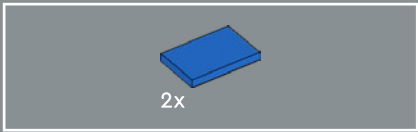

163

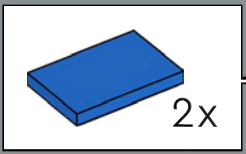
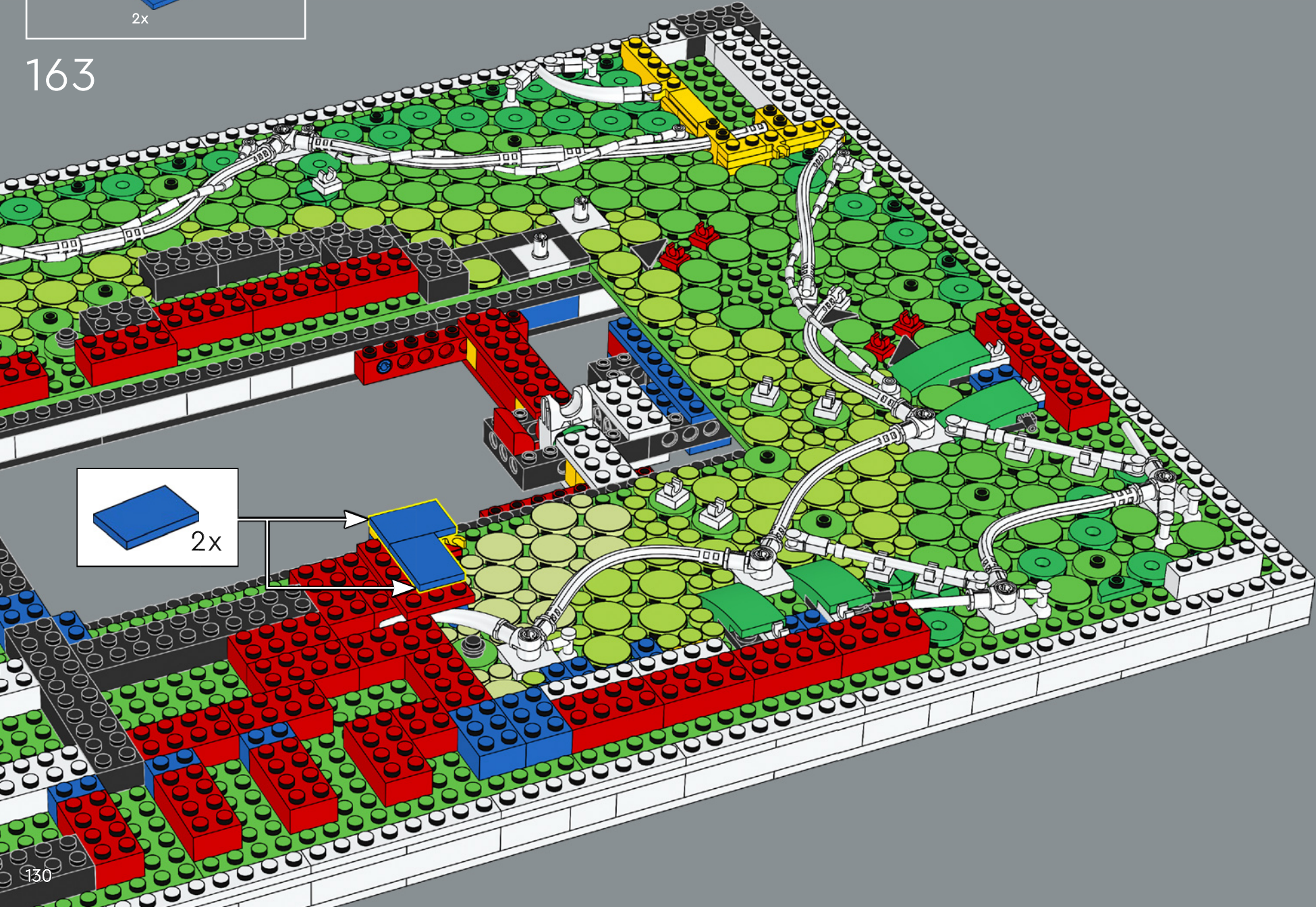

130



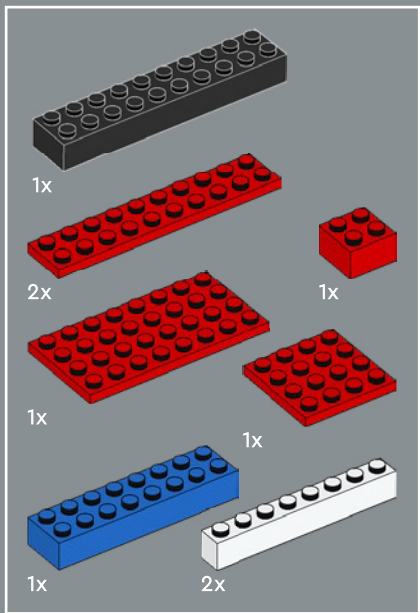

164

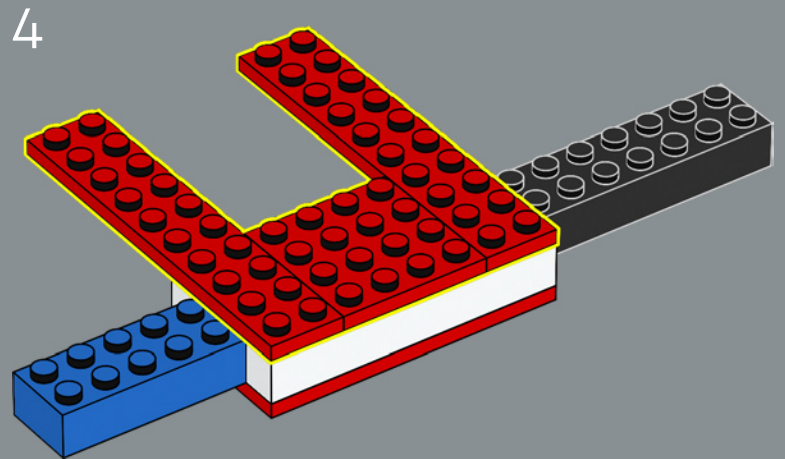
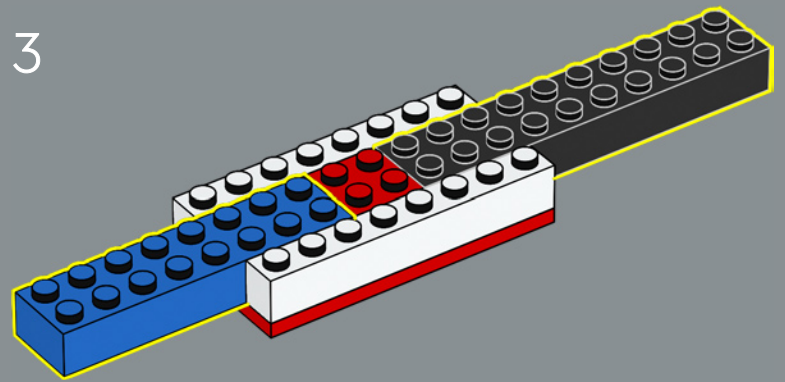
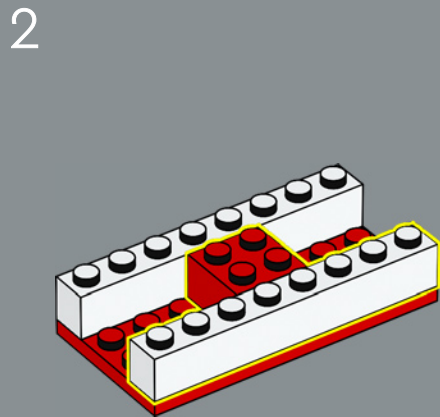
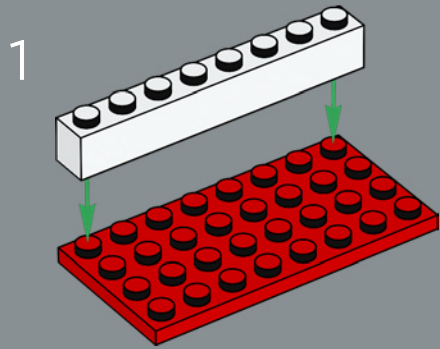



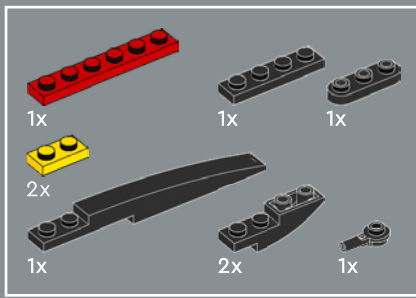

166

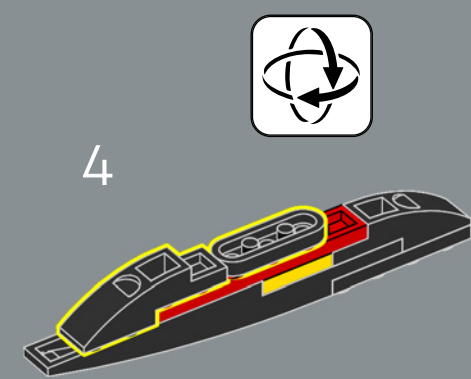
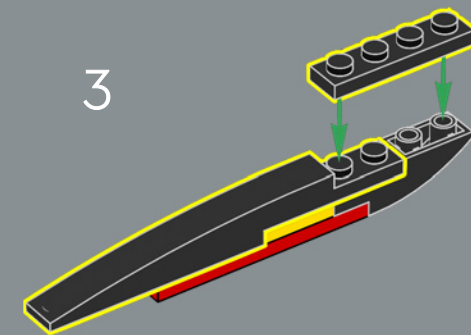
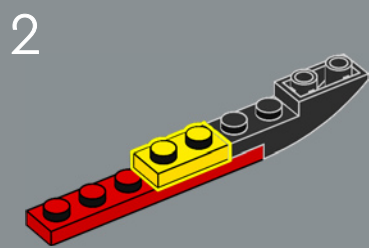
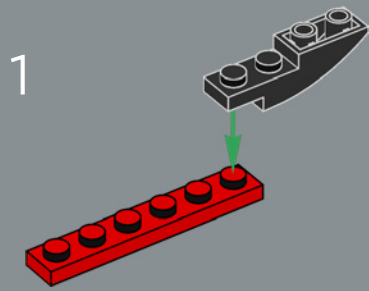

When blue becomes yellow, suddenly this section evokes the costume of Jessica Drew aka Spider-Woman, who first appeared in Marvel Spotlight #32 from 1977!

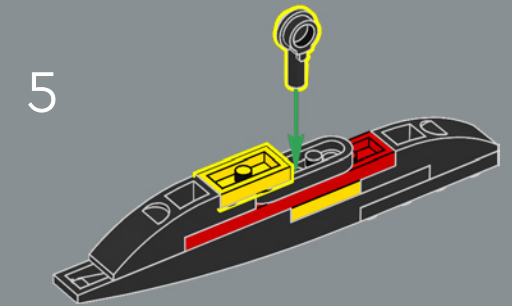

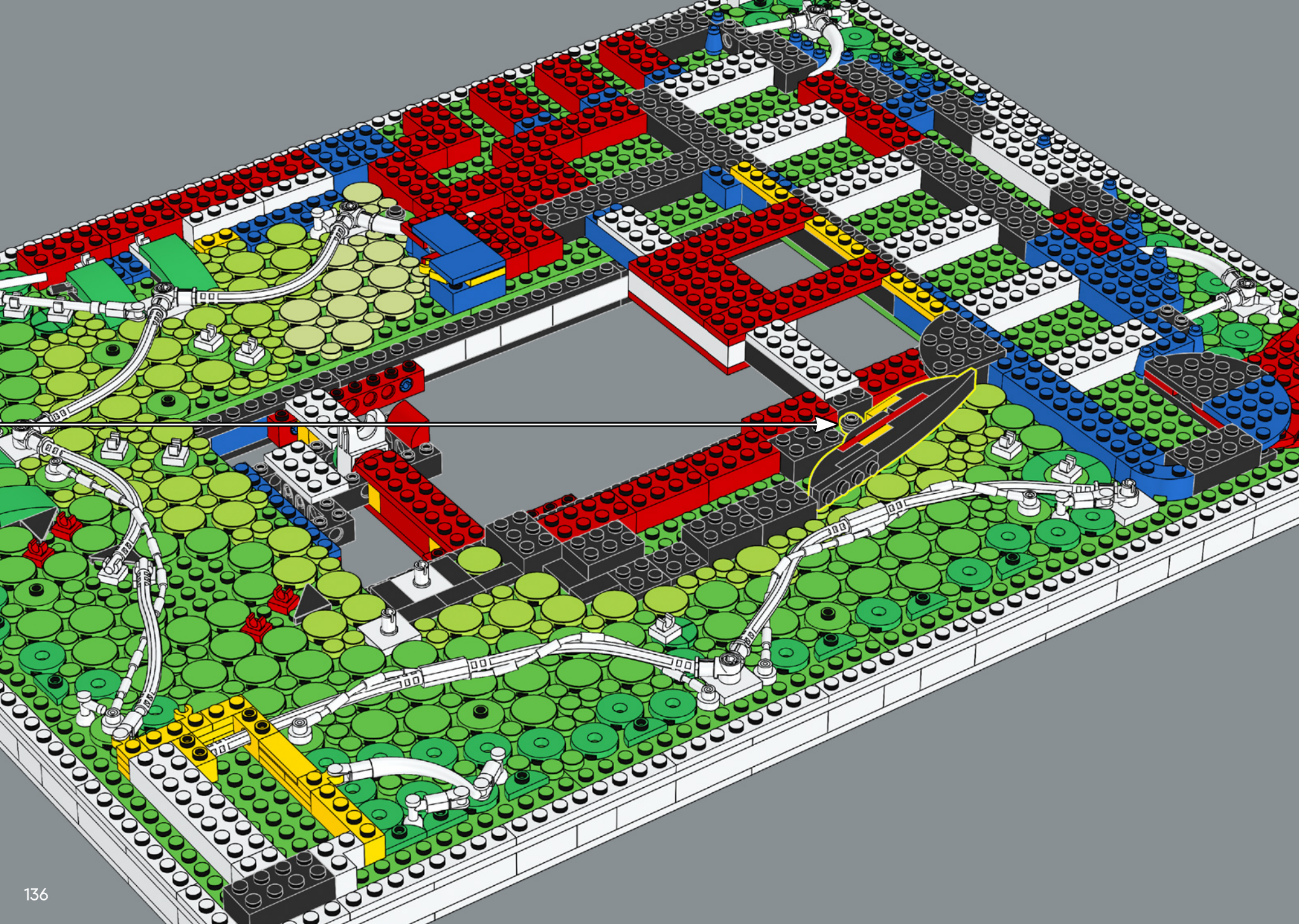

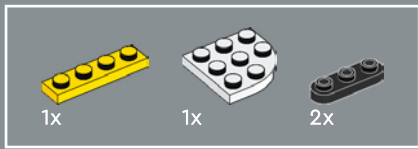

167

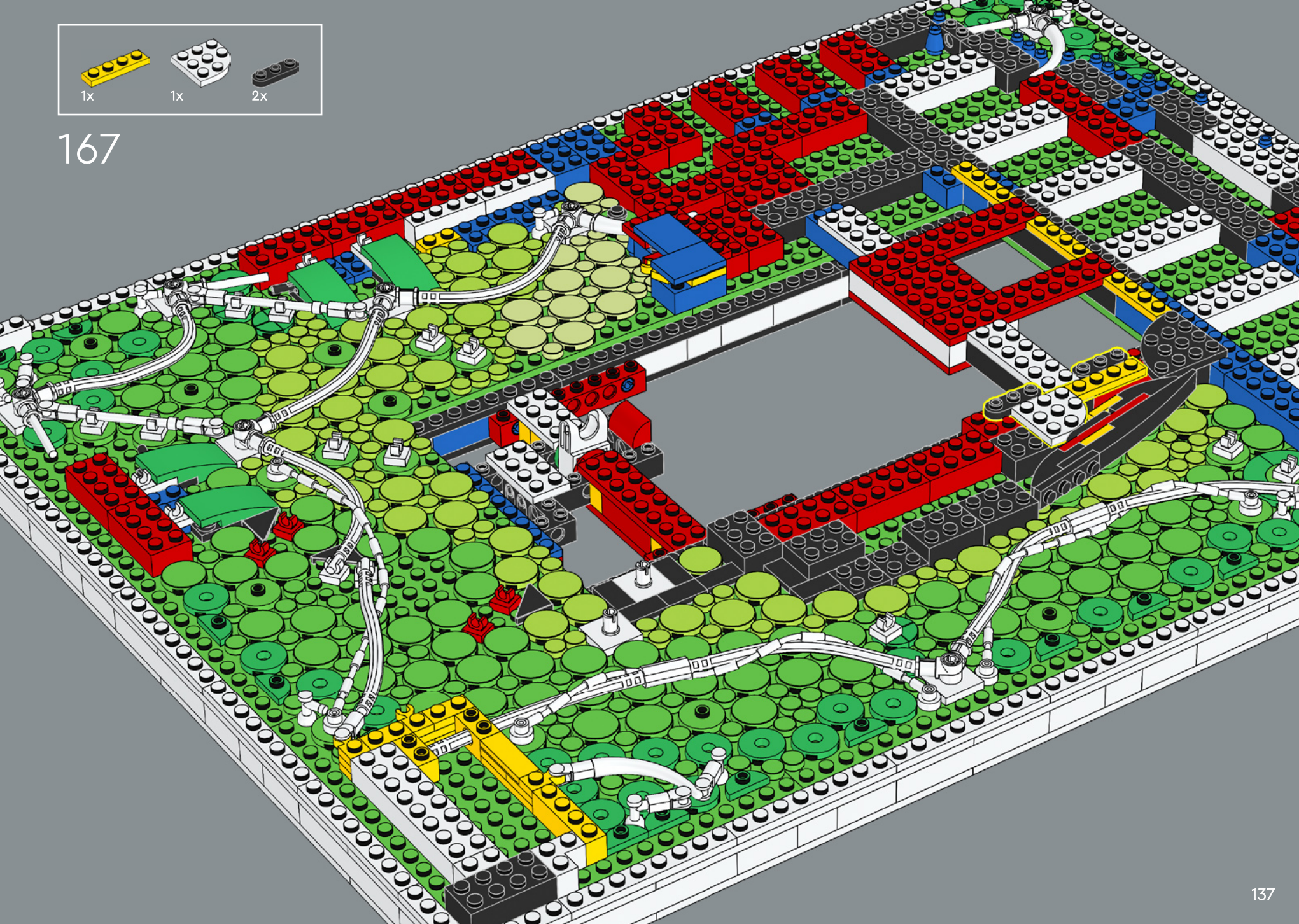

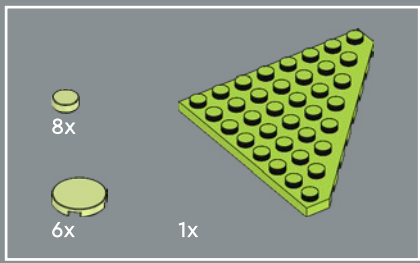

168

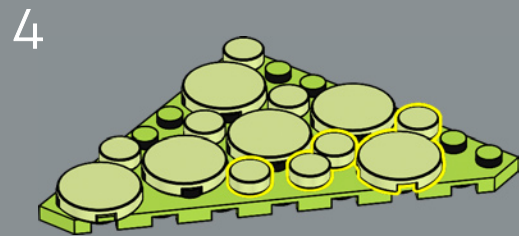
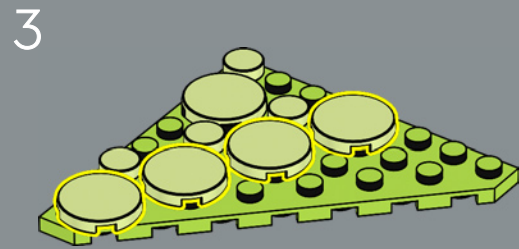
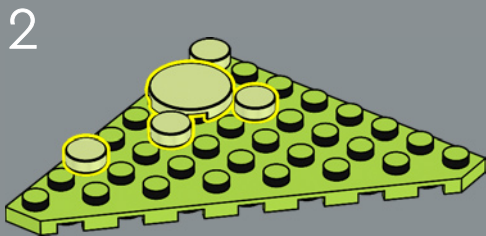
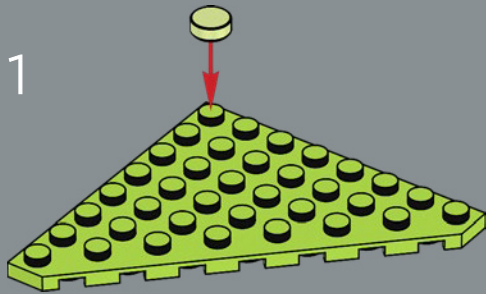



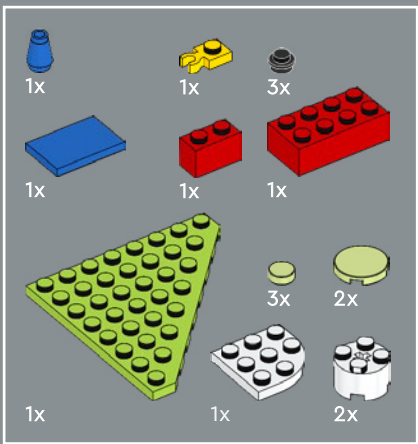

169

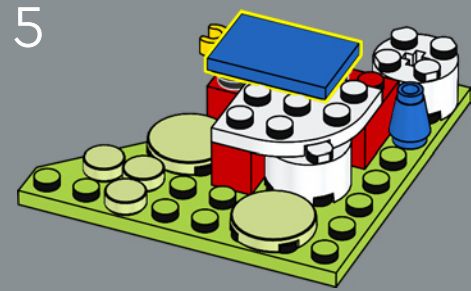
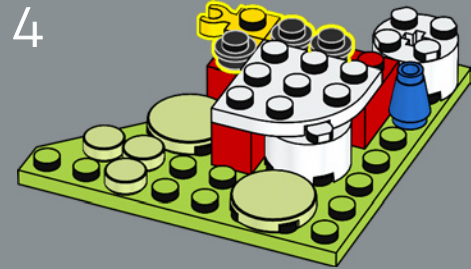
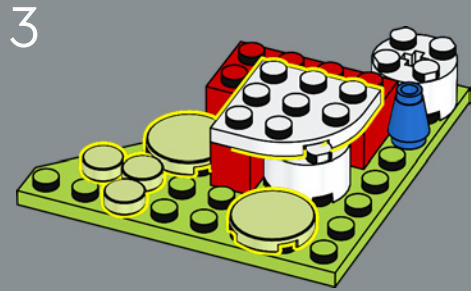
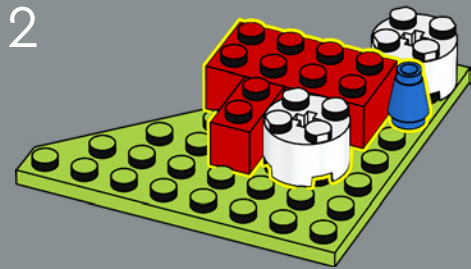
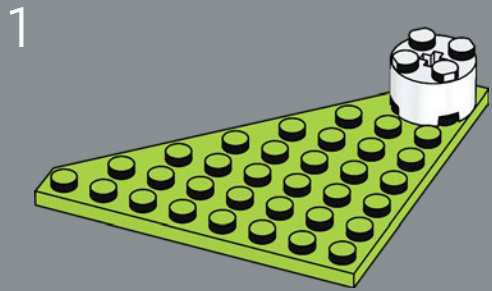

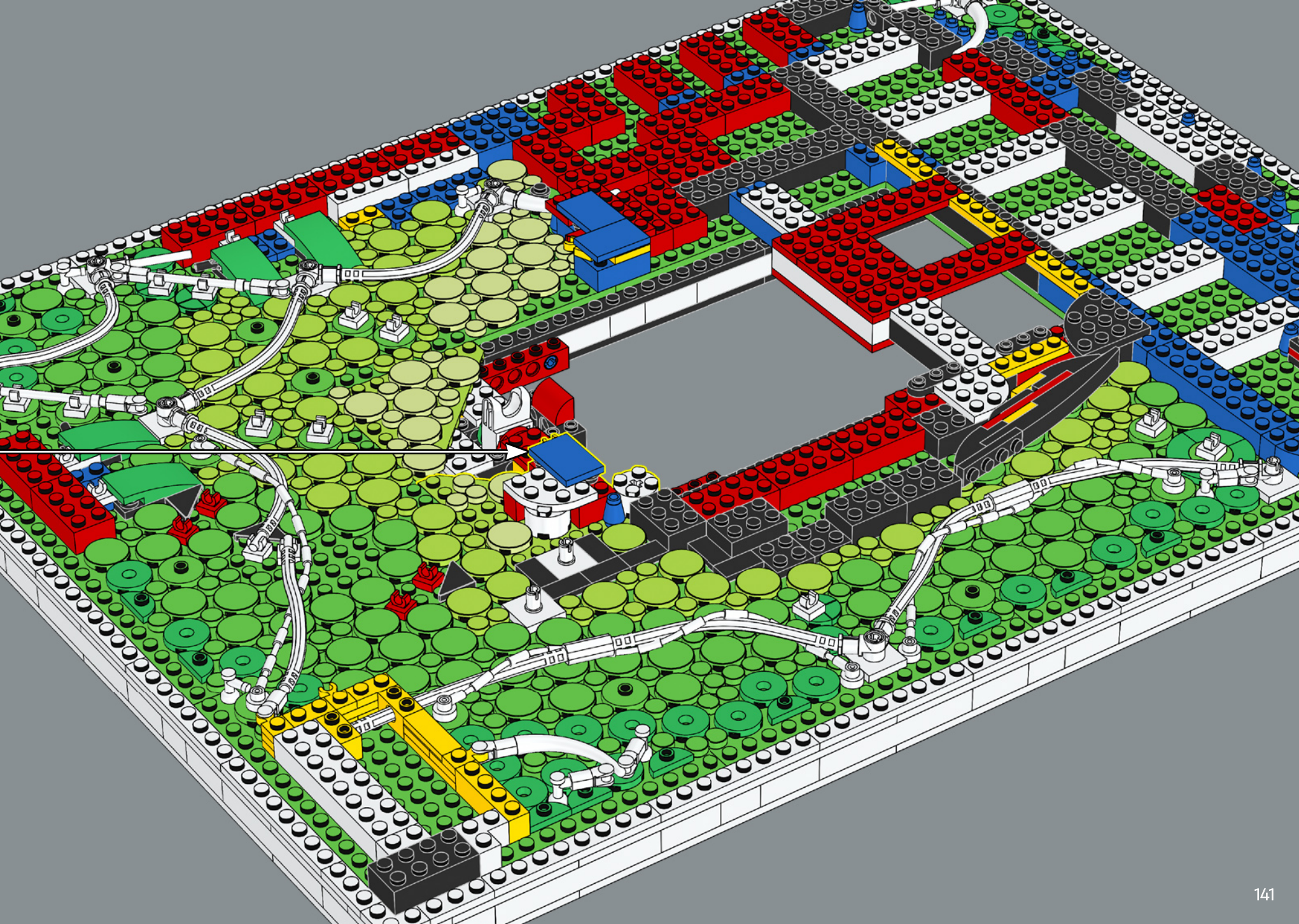

4x

170

4x

142

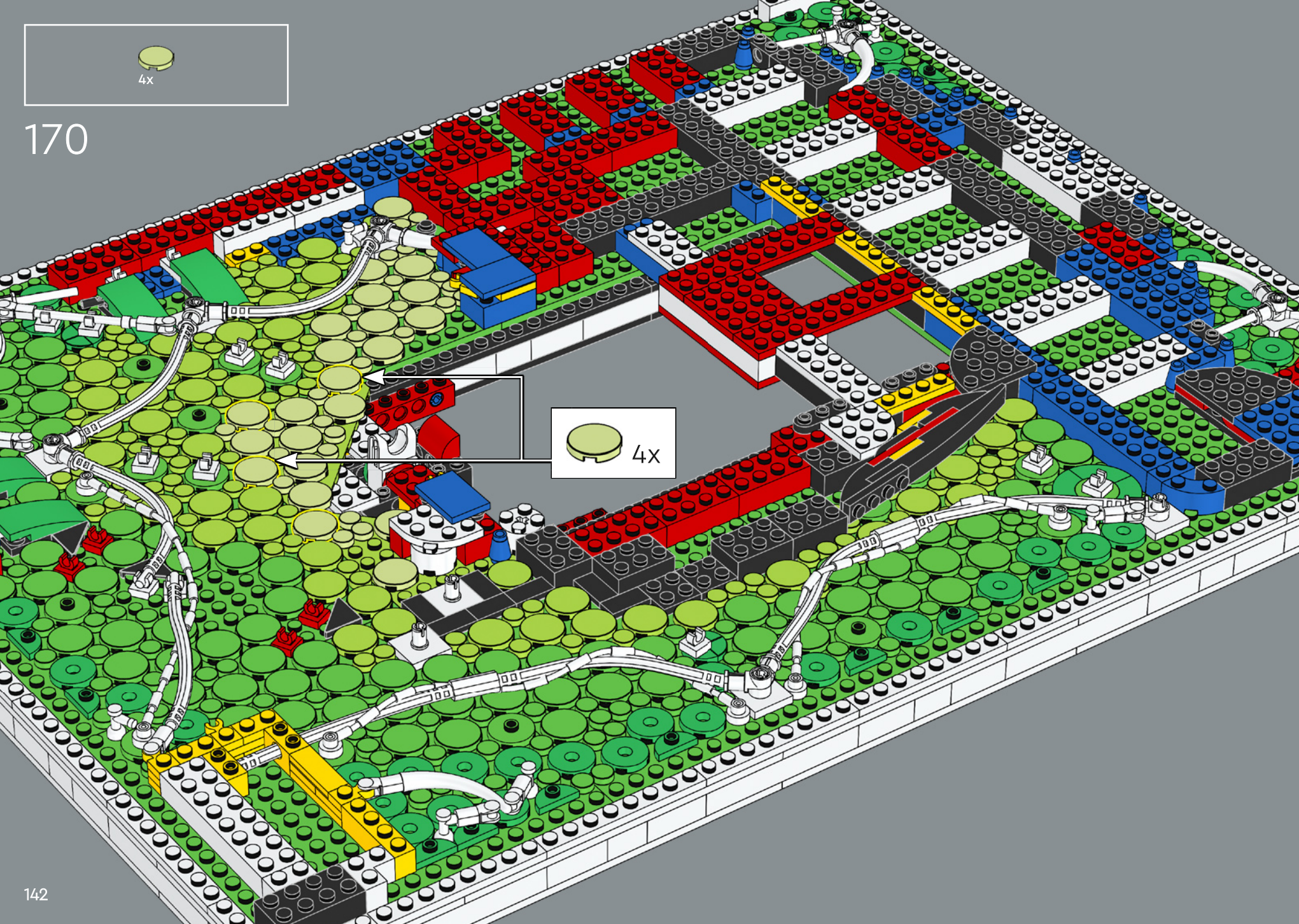

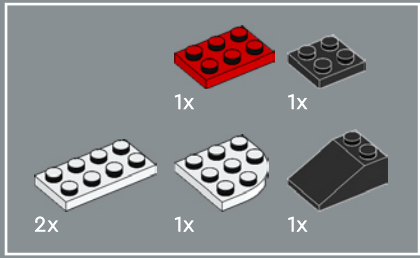

171

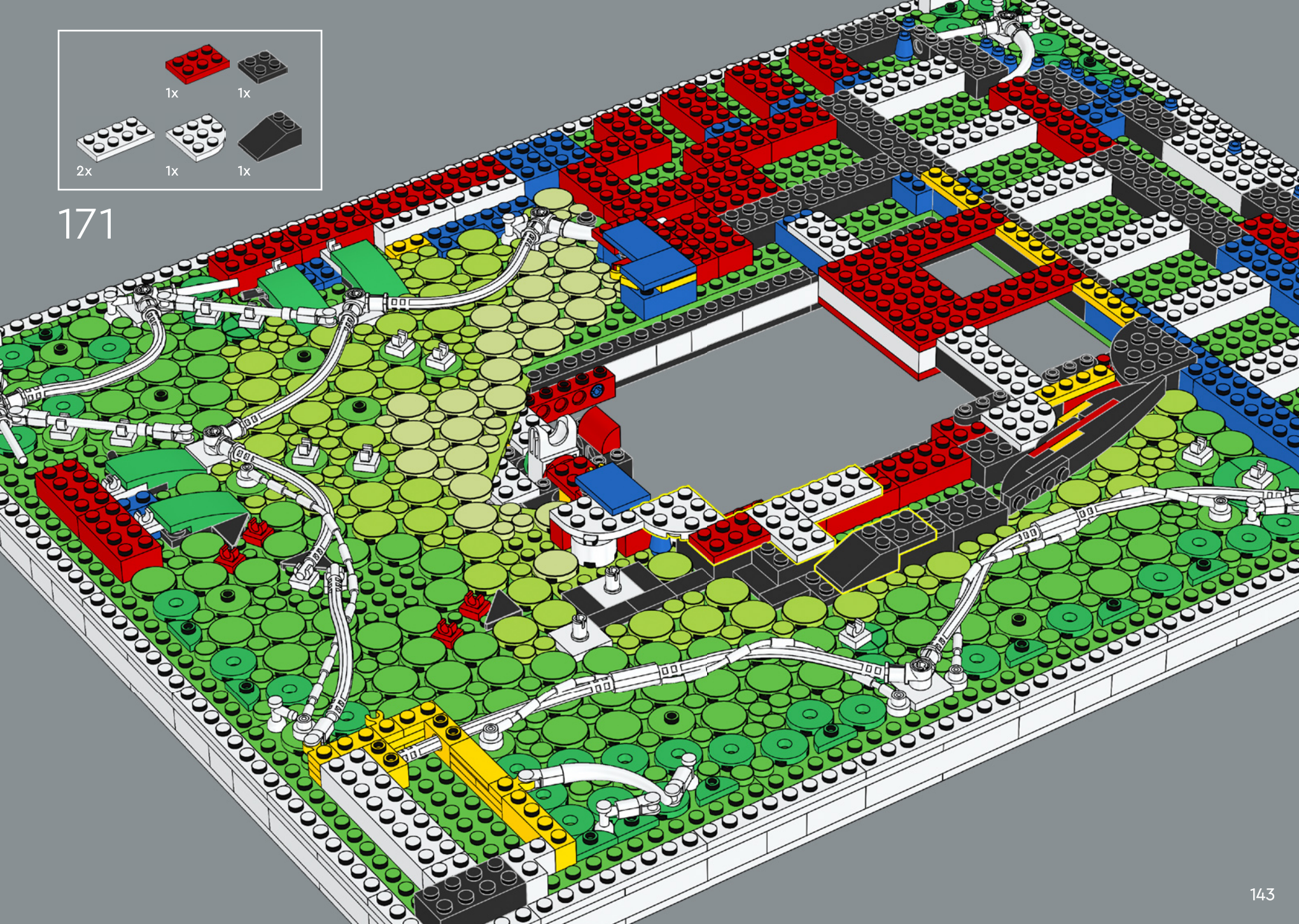

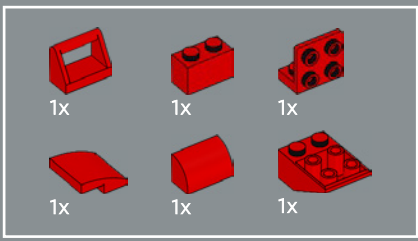

172

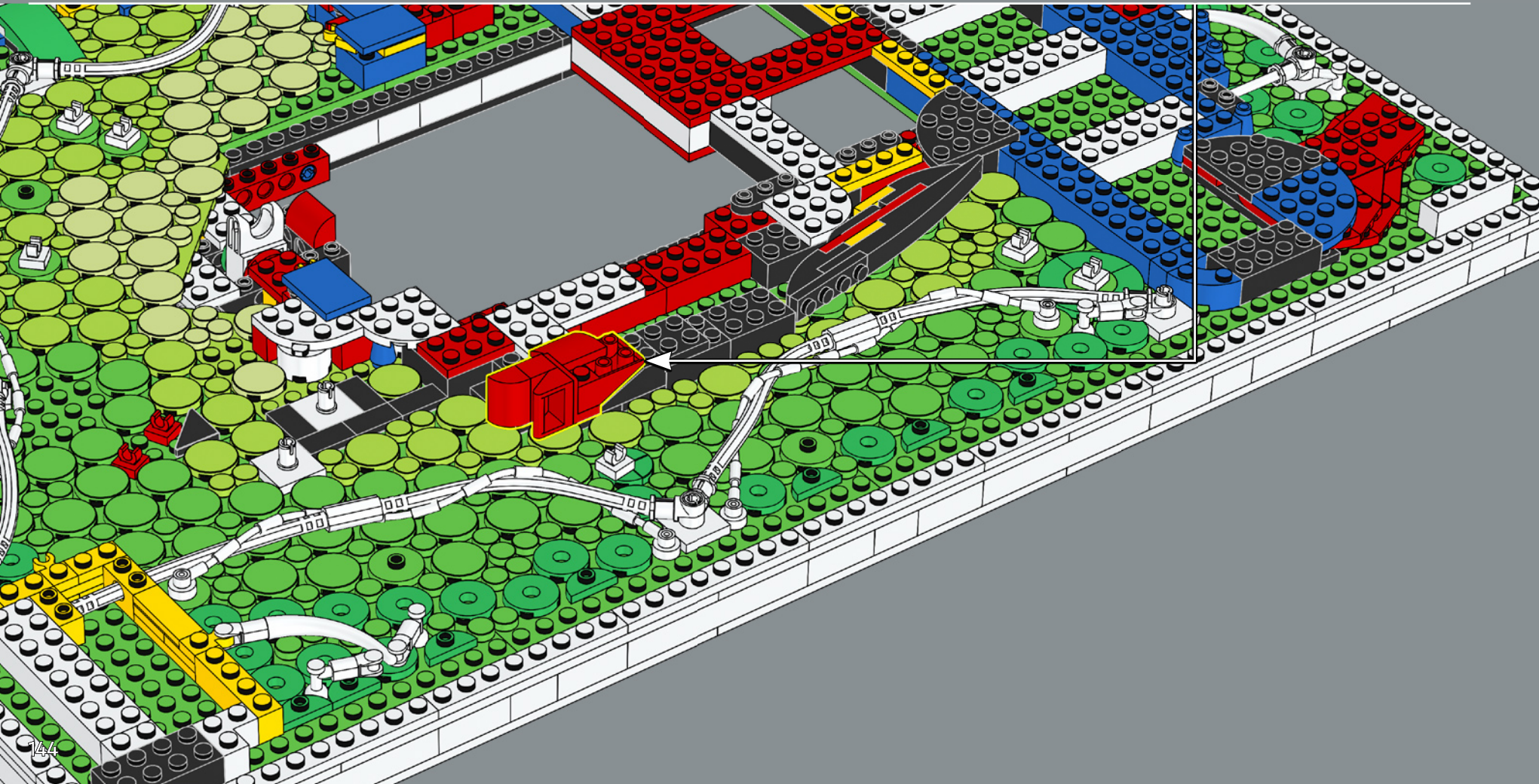
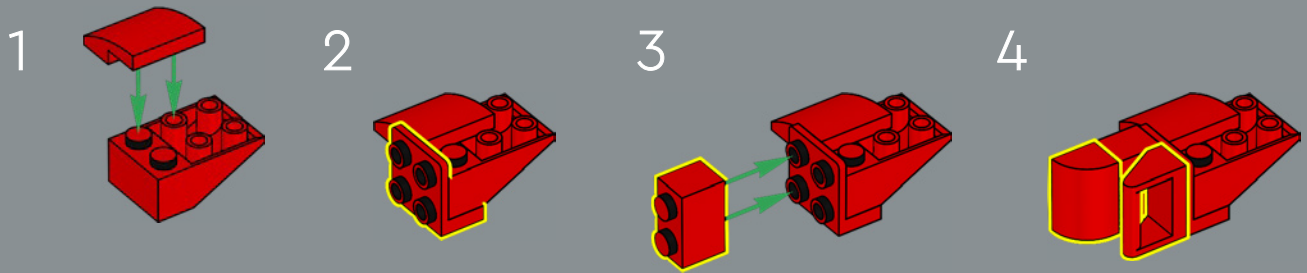

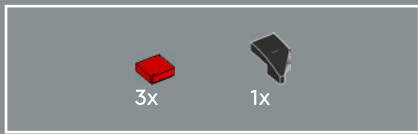

173

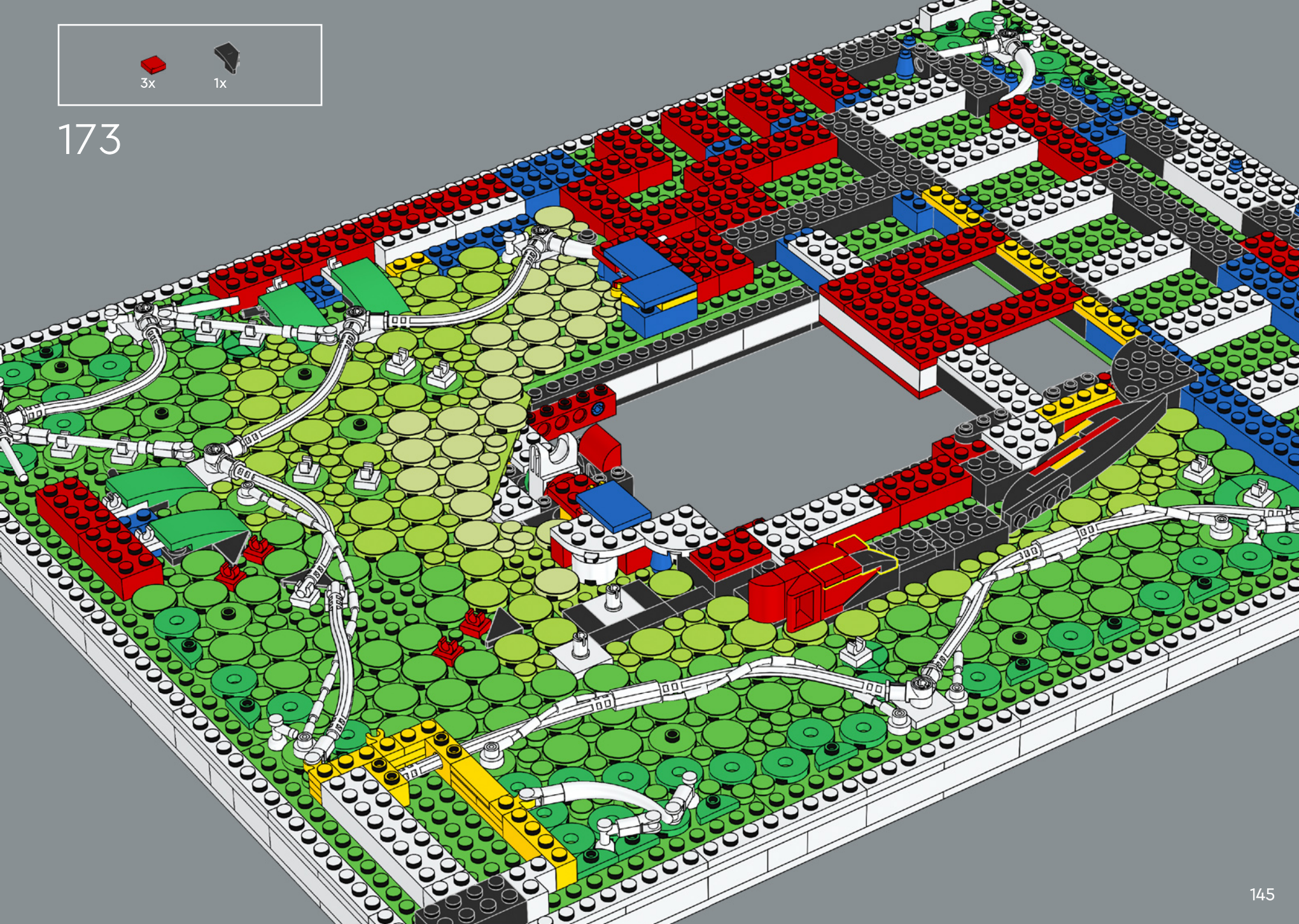

- 2x 
- 3x 

174

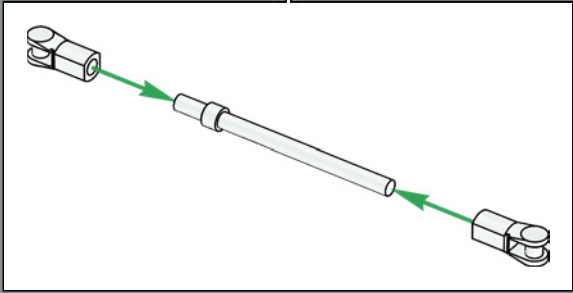
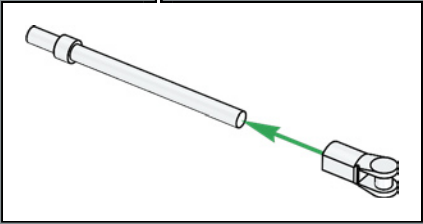
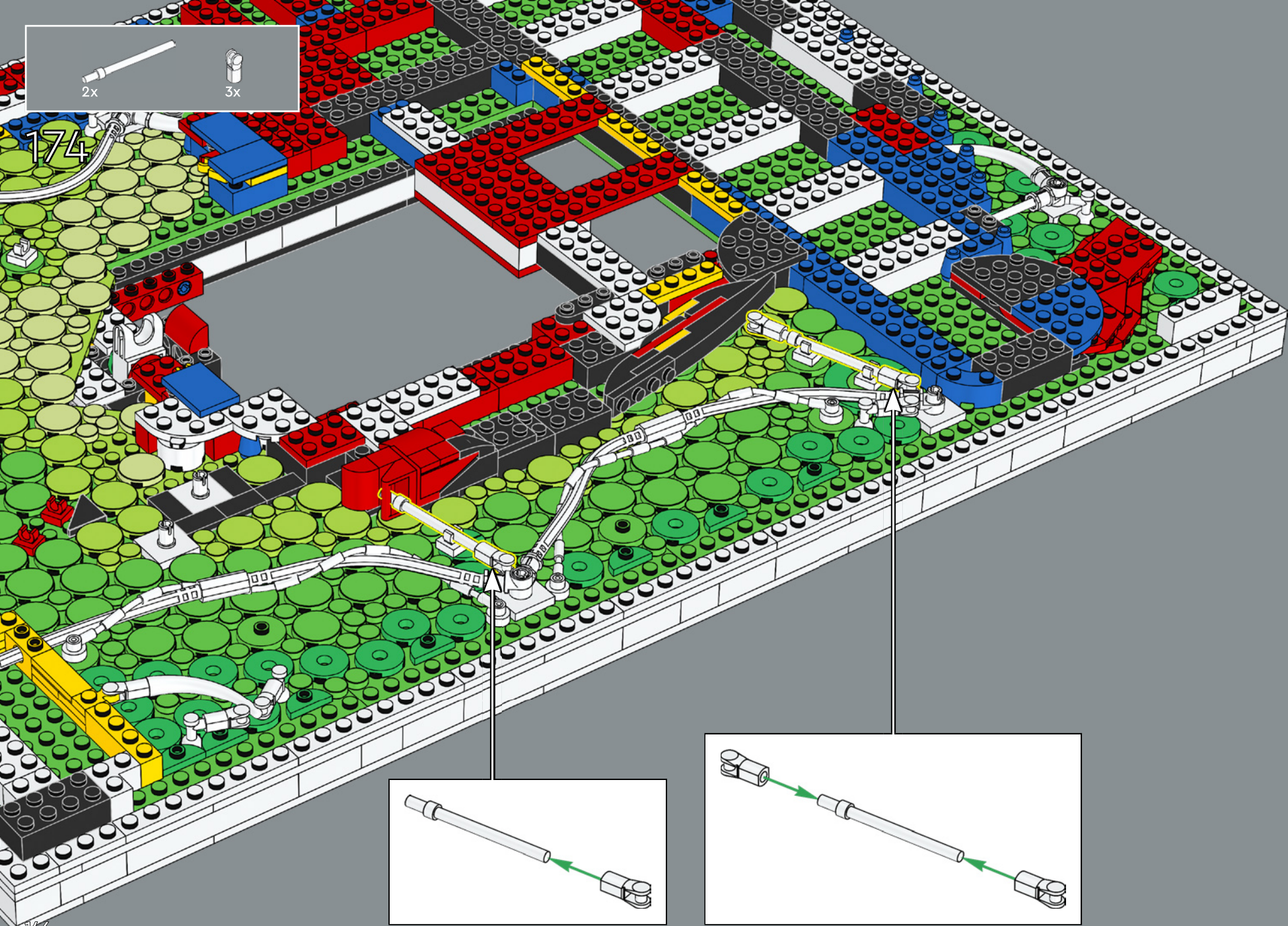

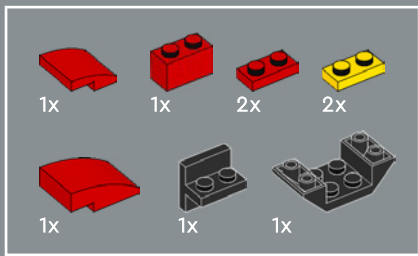

175

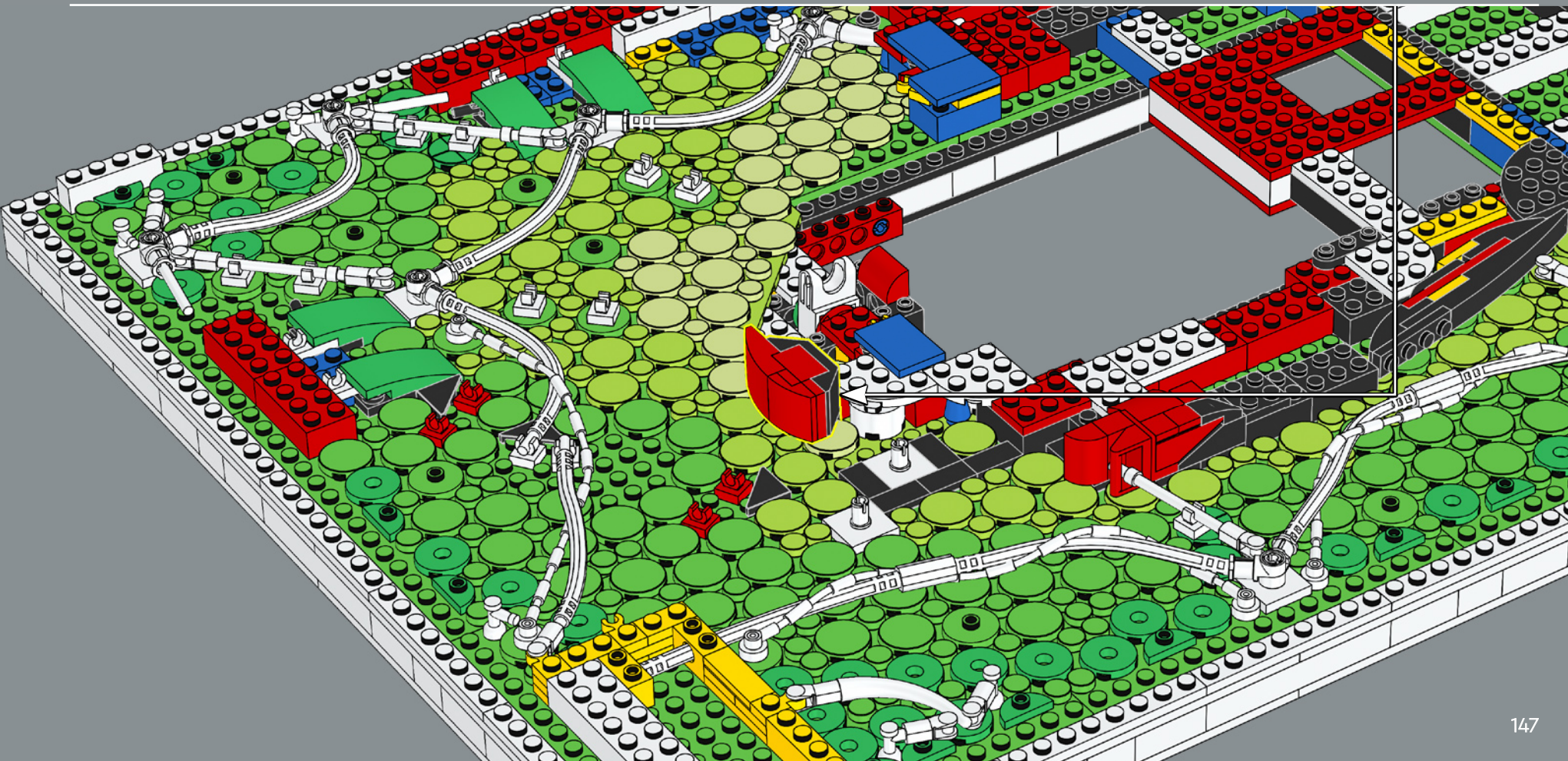
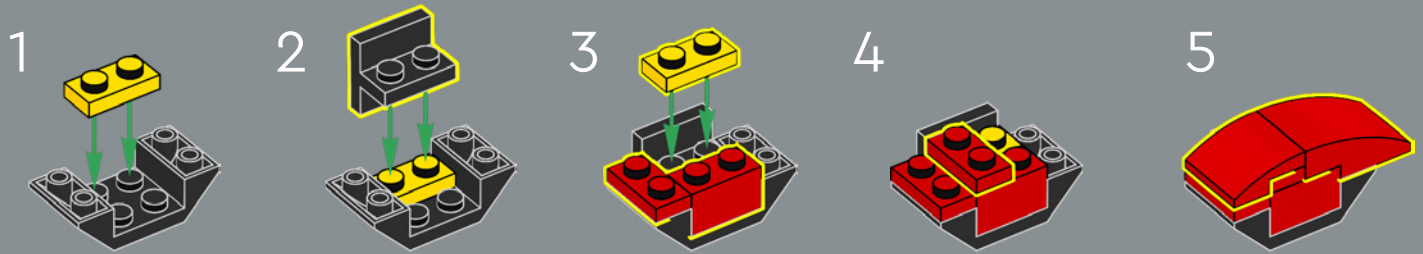

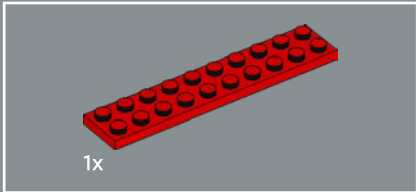
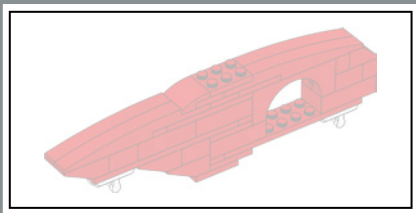

176

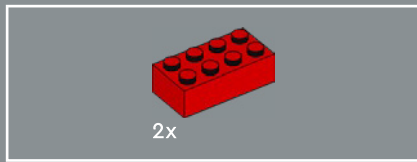
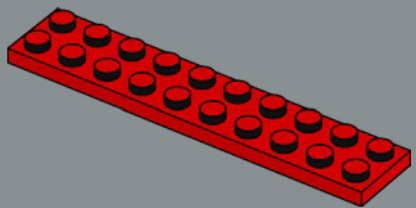

177

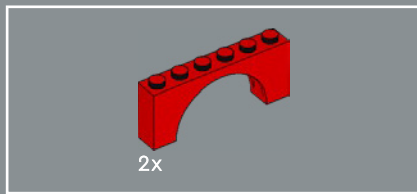
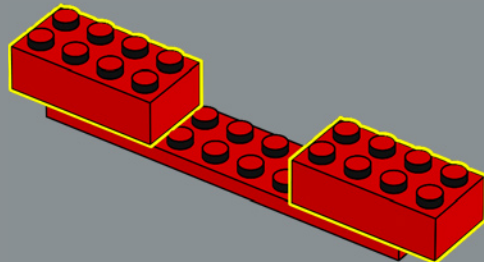

178

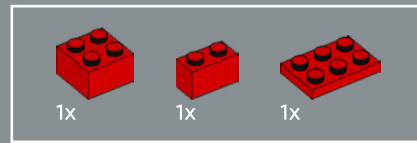
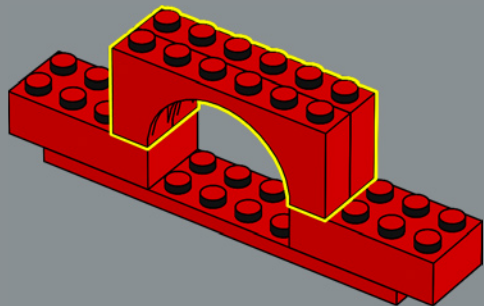

179

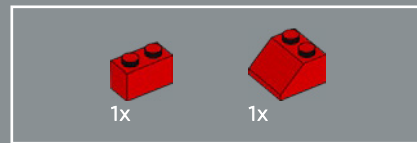
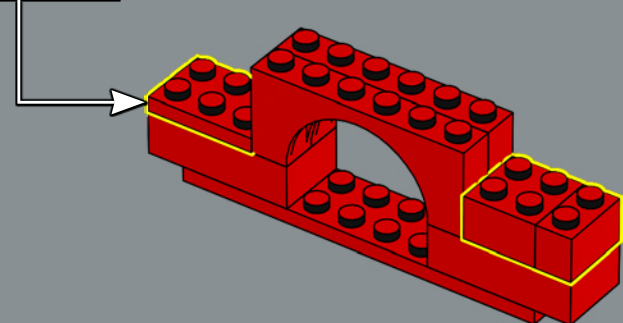
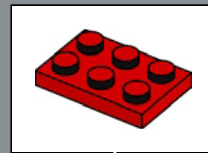

180

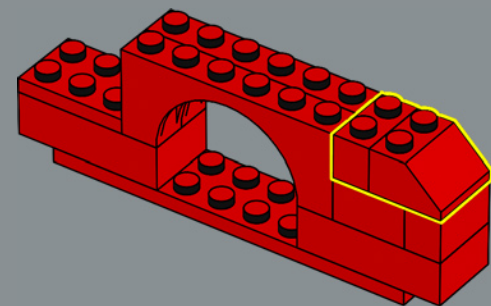

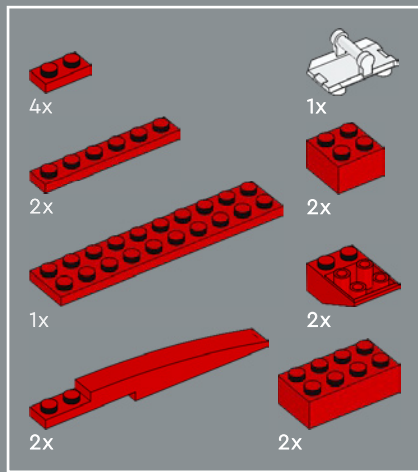

181

1

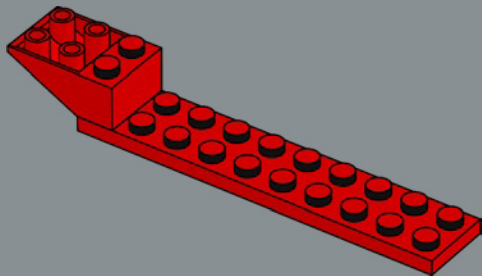

2

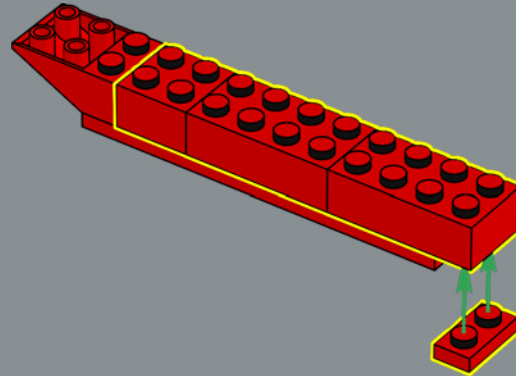

3

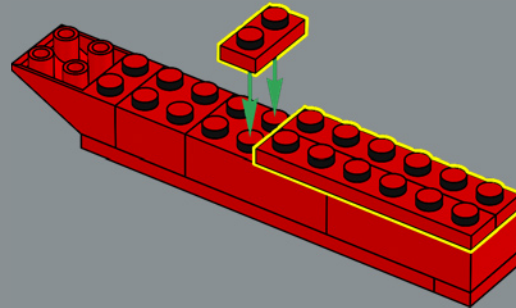

This is the 42nd red 2x4 brick you have placed in this model!

4

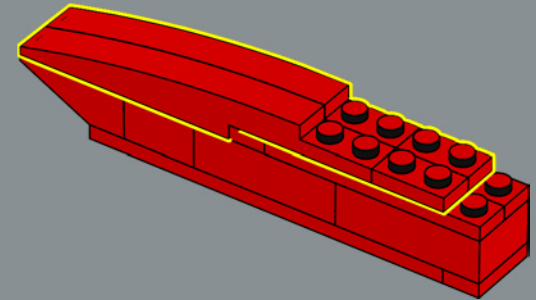

5

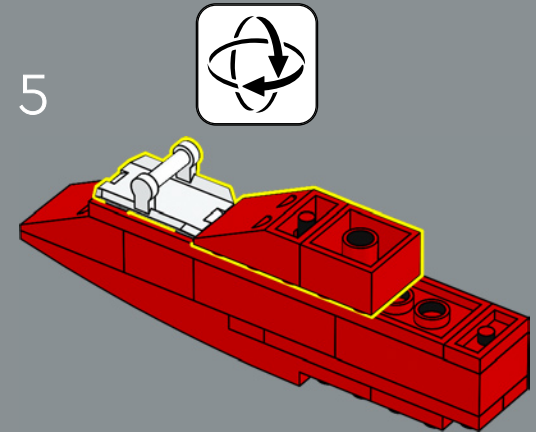

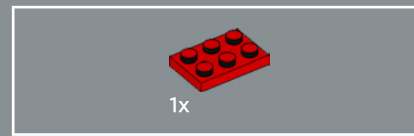
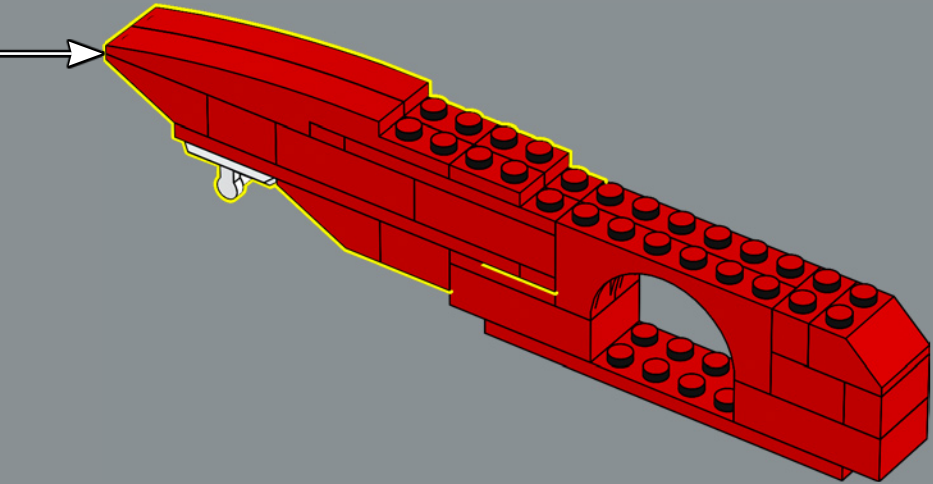

182

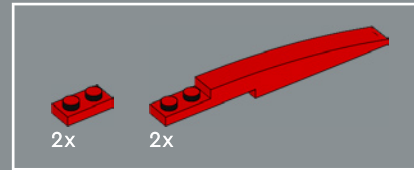
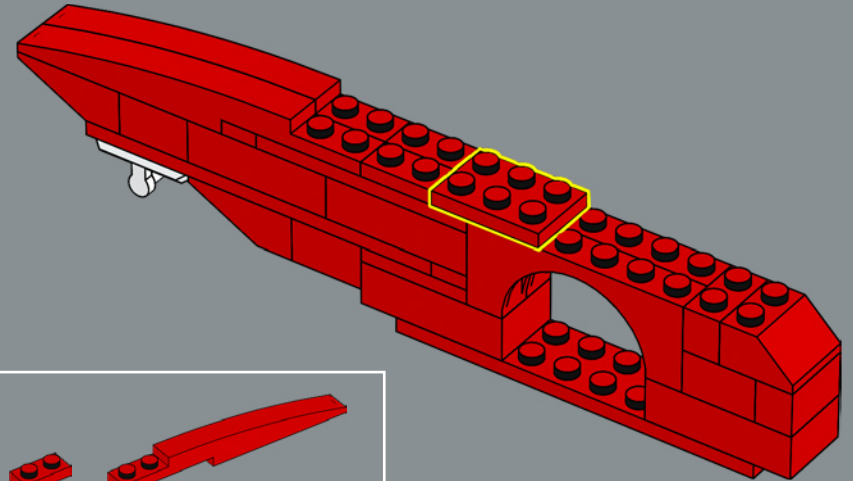

183

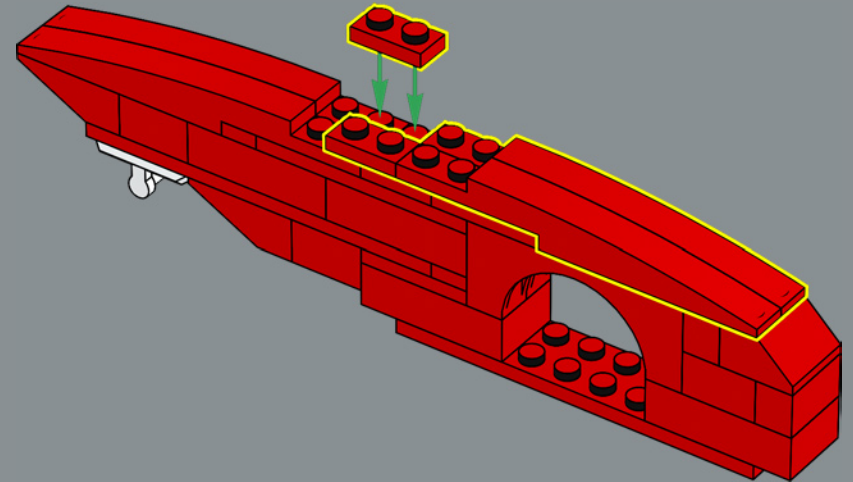

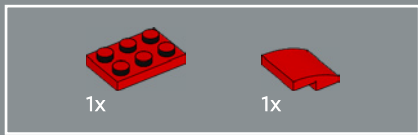

184

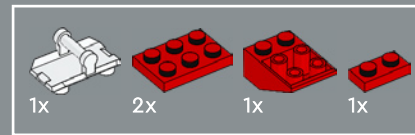
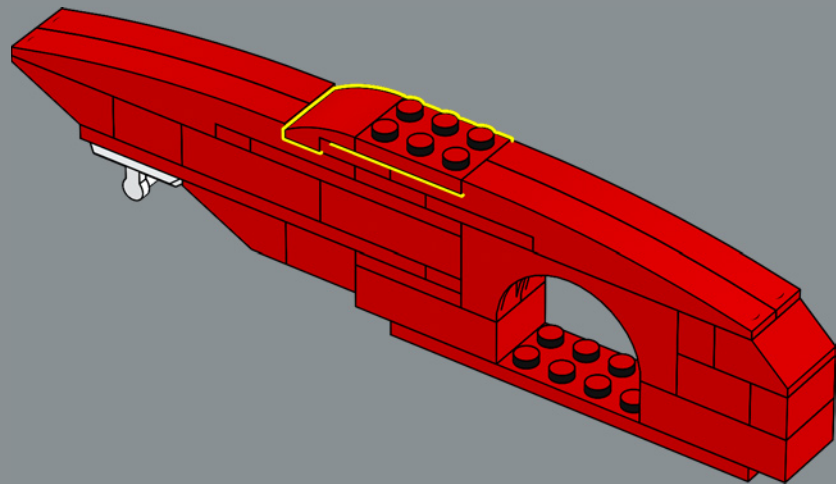

185

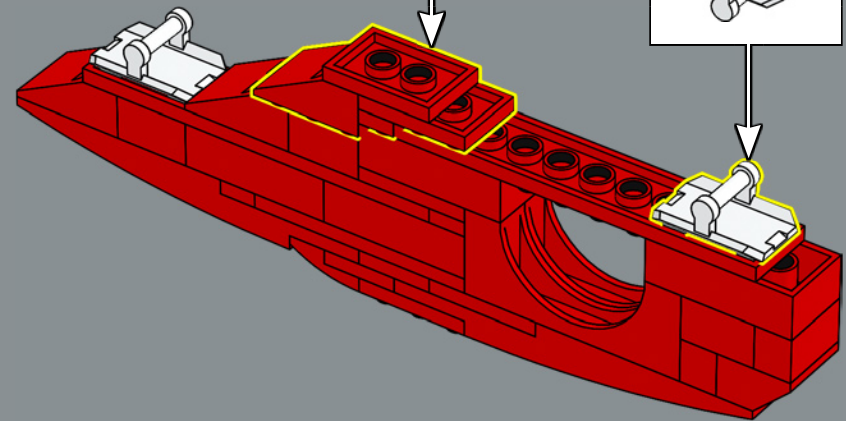
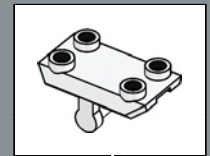
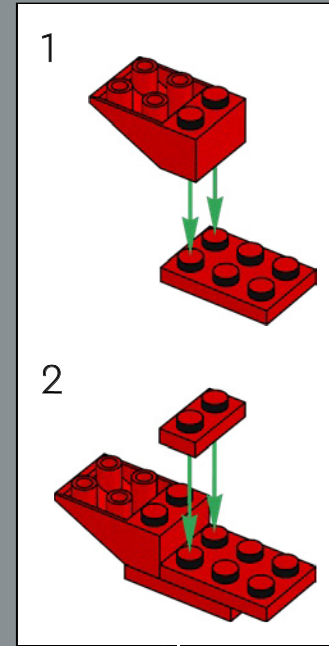

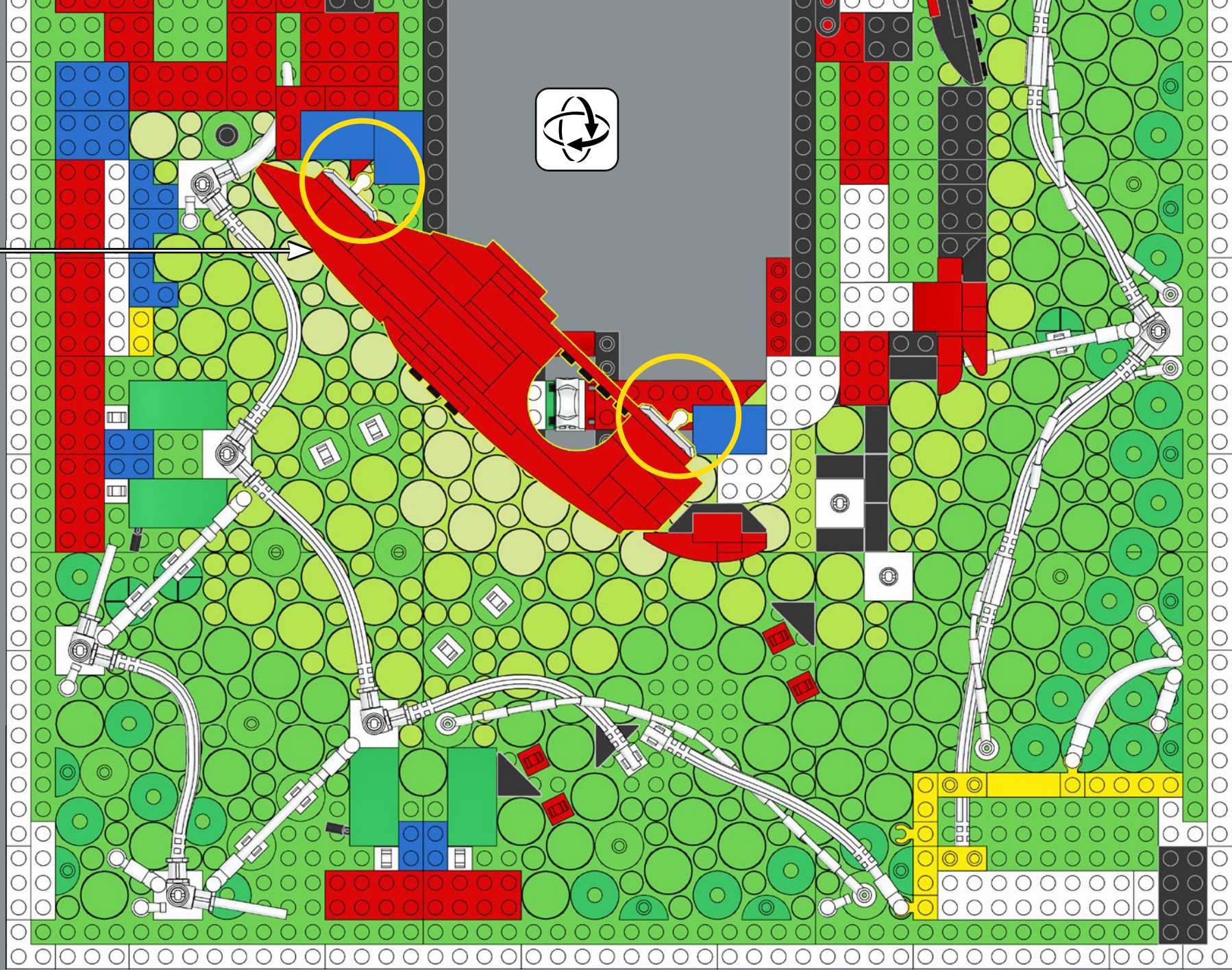
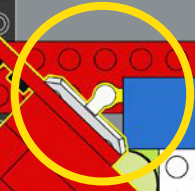
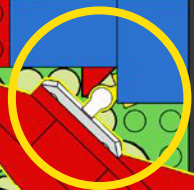

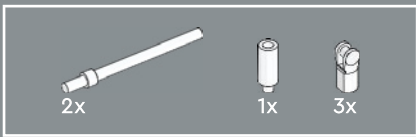

Originally designed as a candle, this element now serves as a web line!

187

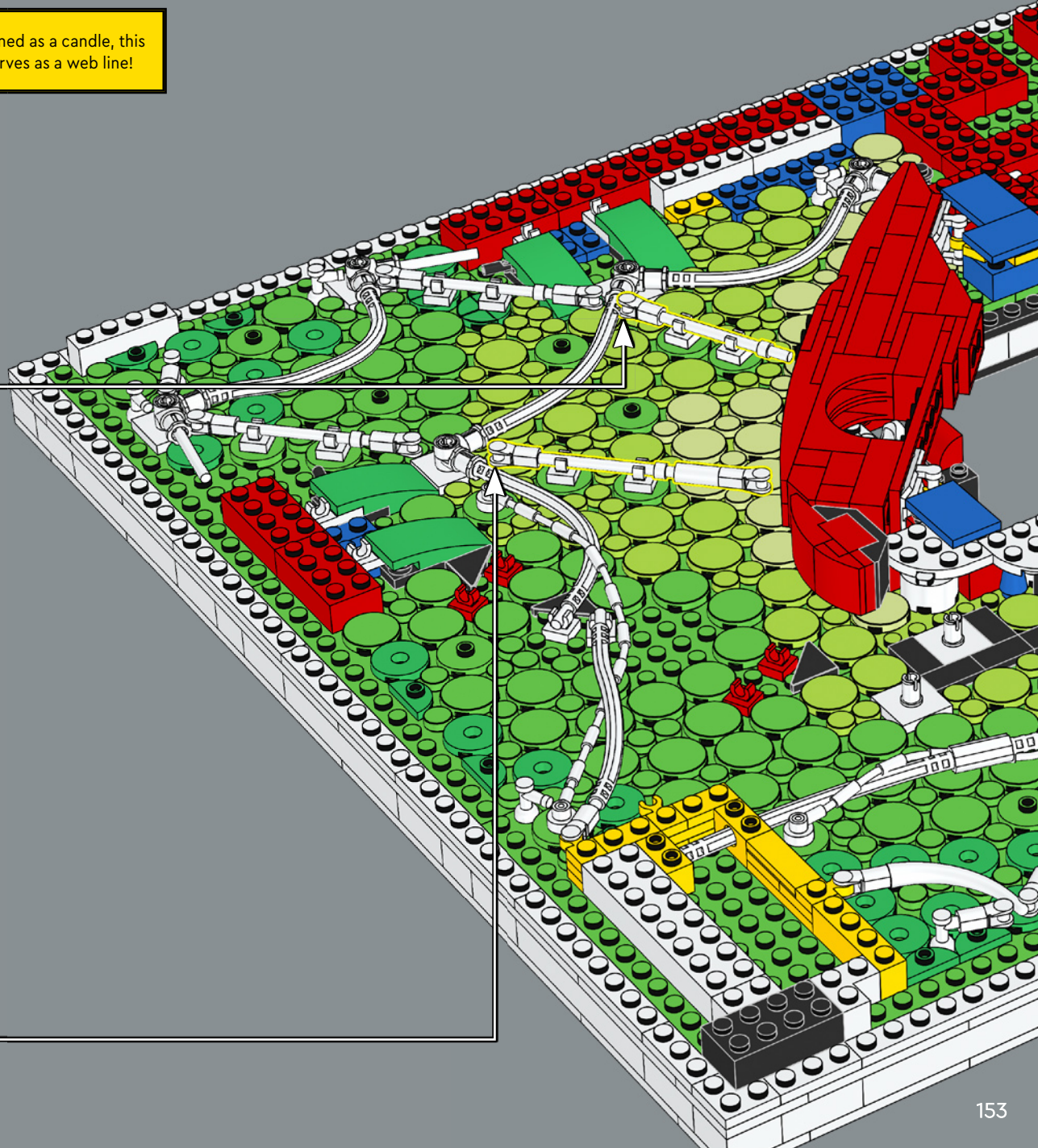
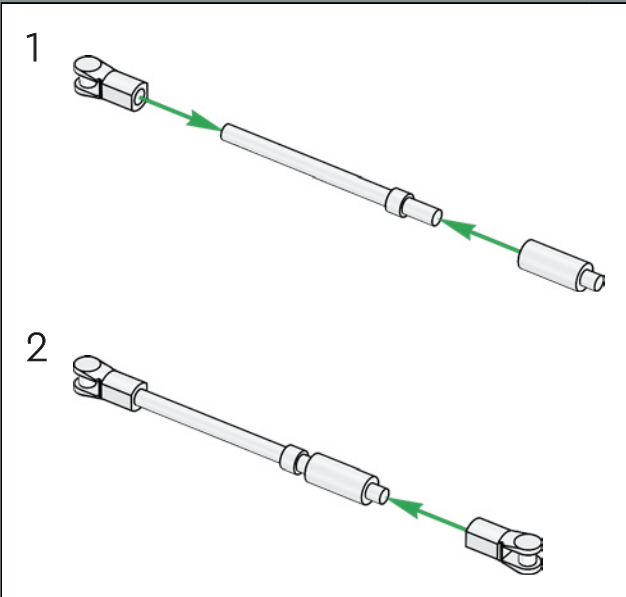
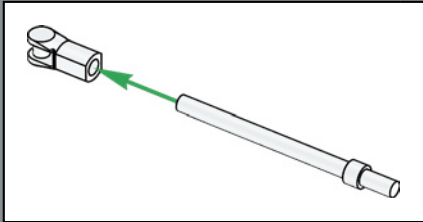

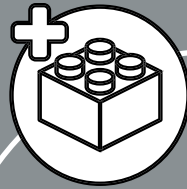

1x

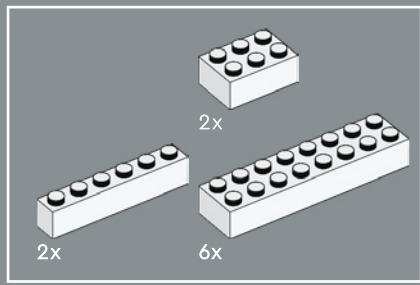

188

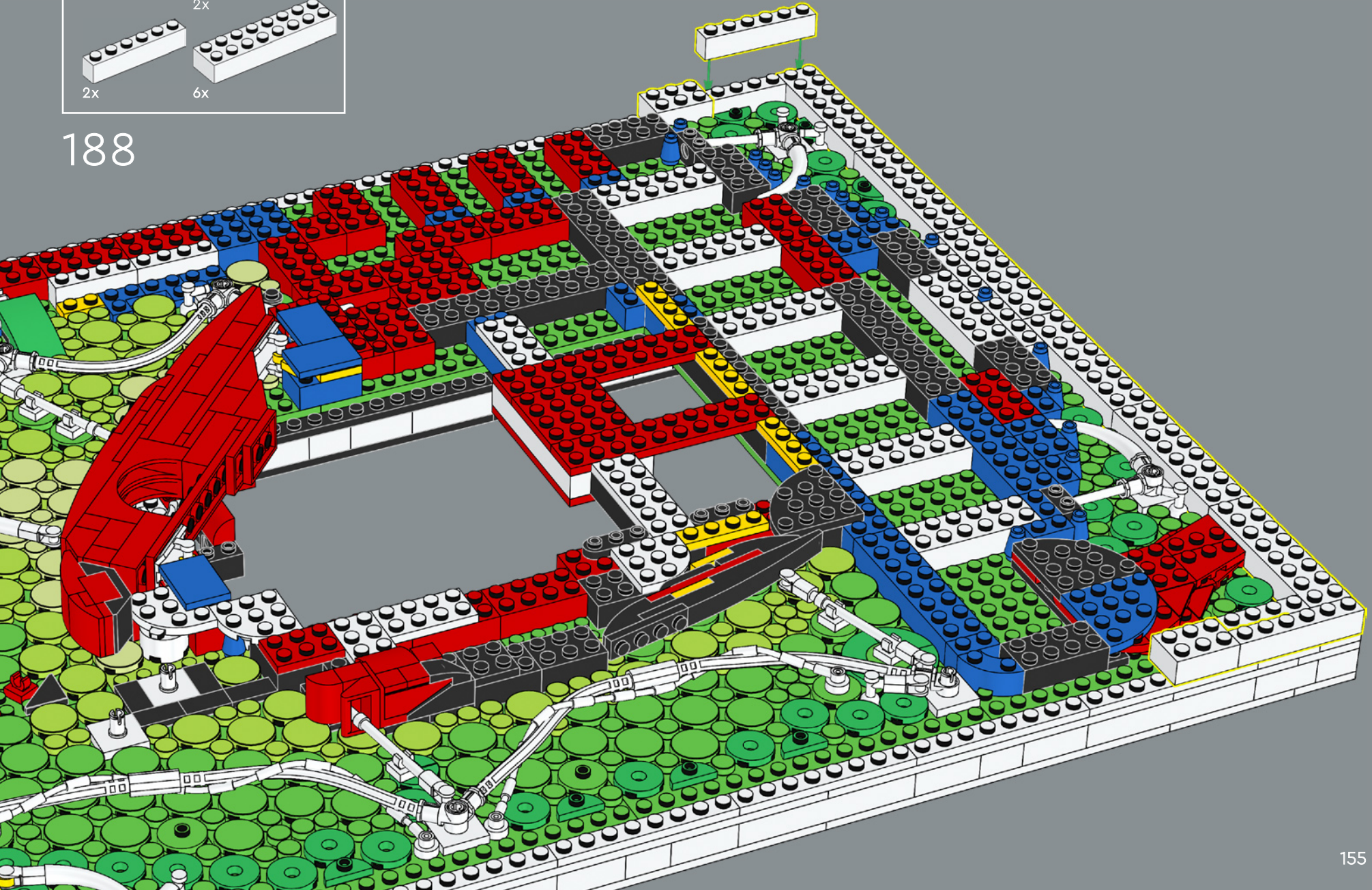

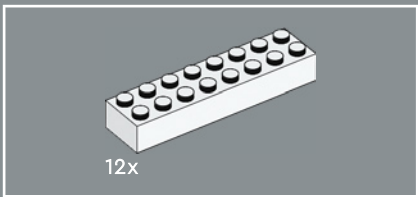

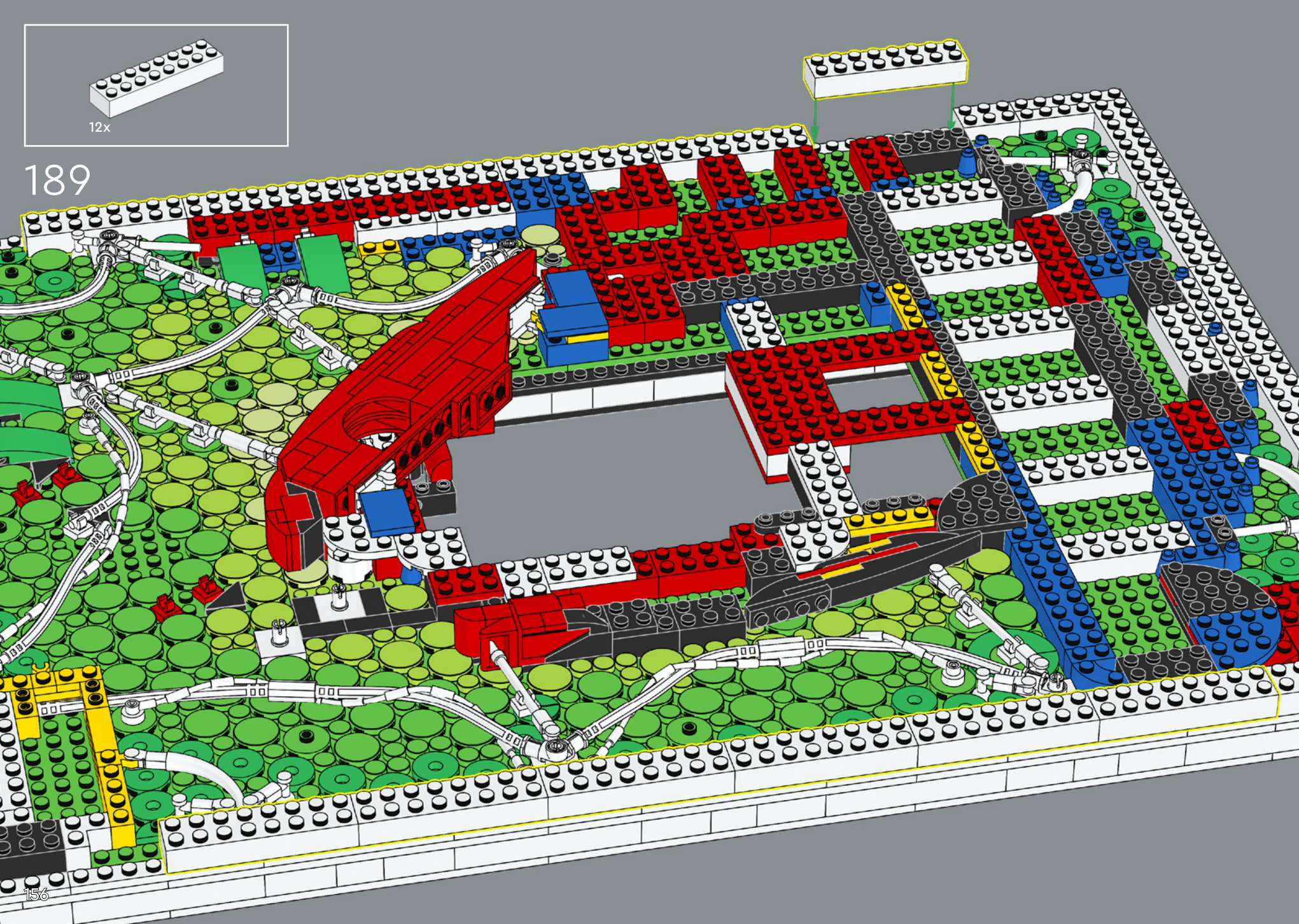

189

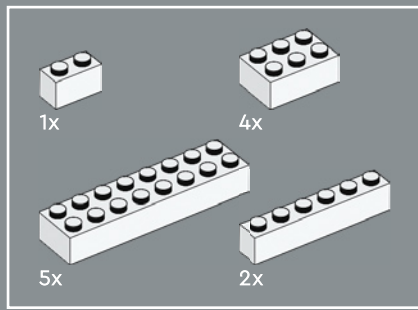

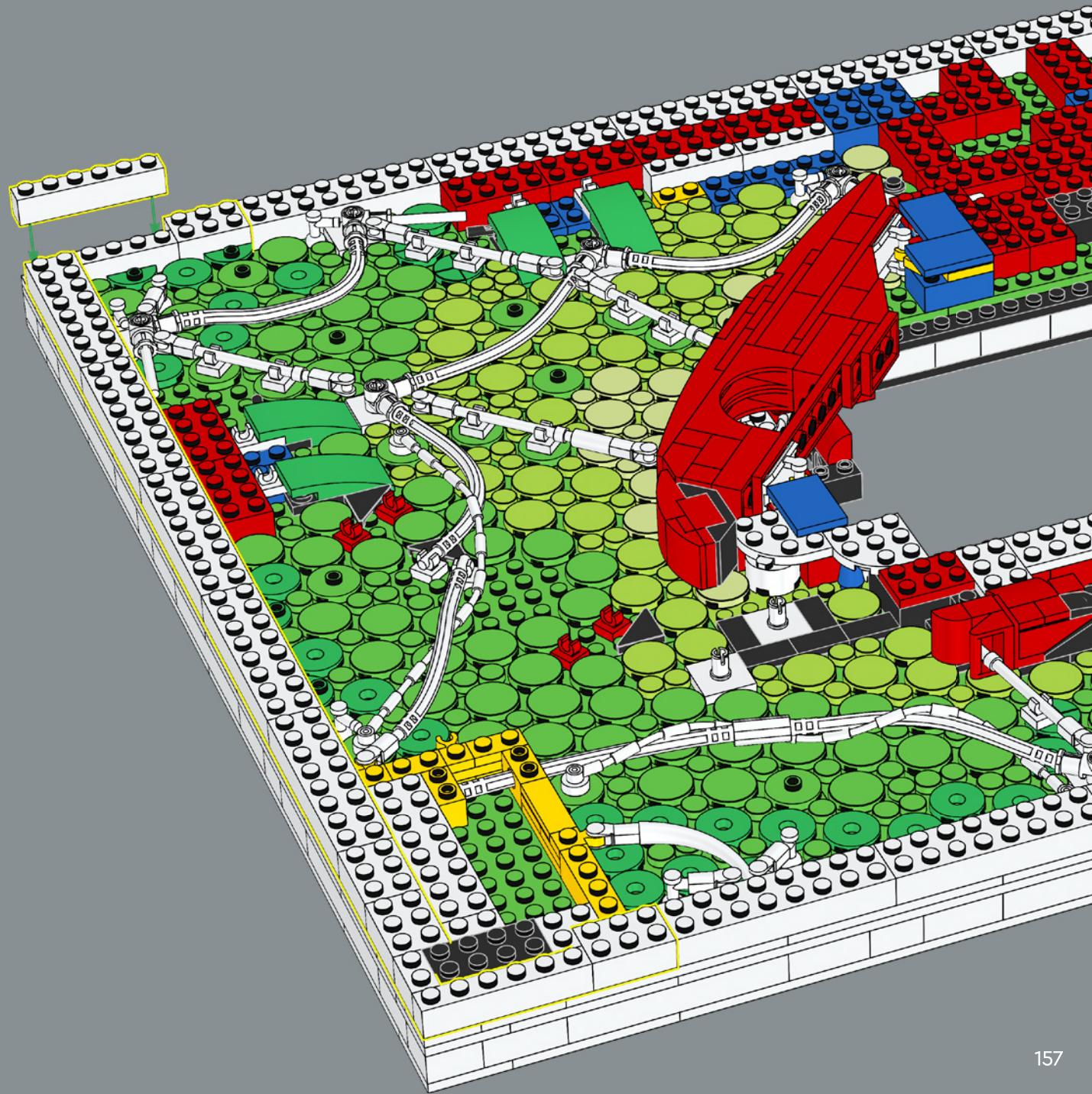

190



4x  2x 

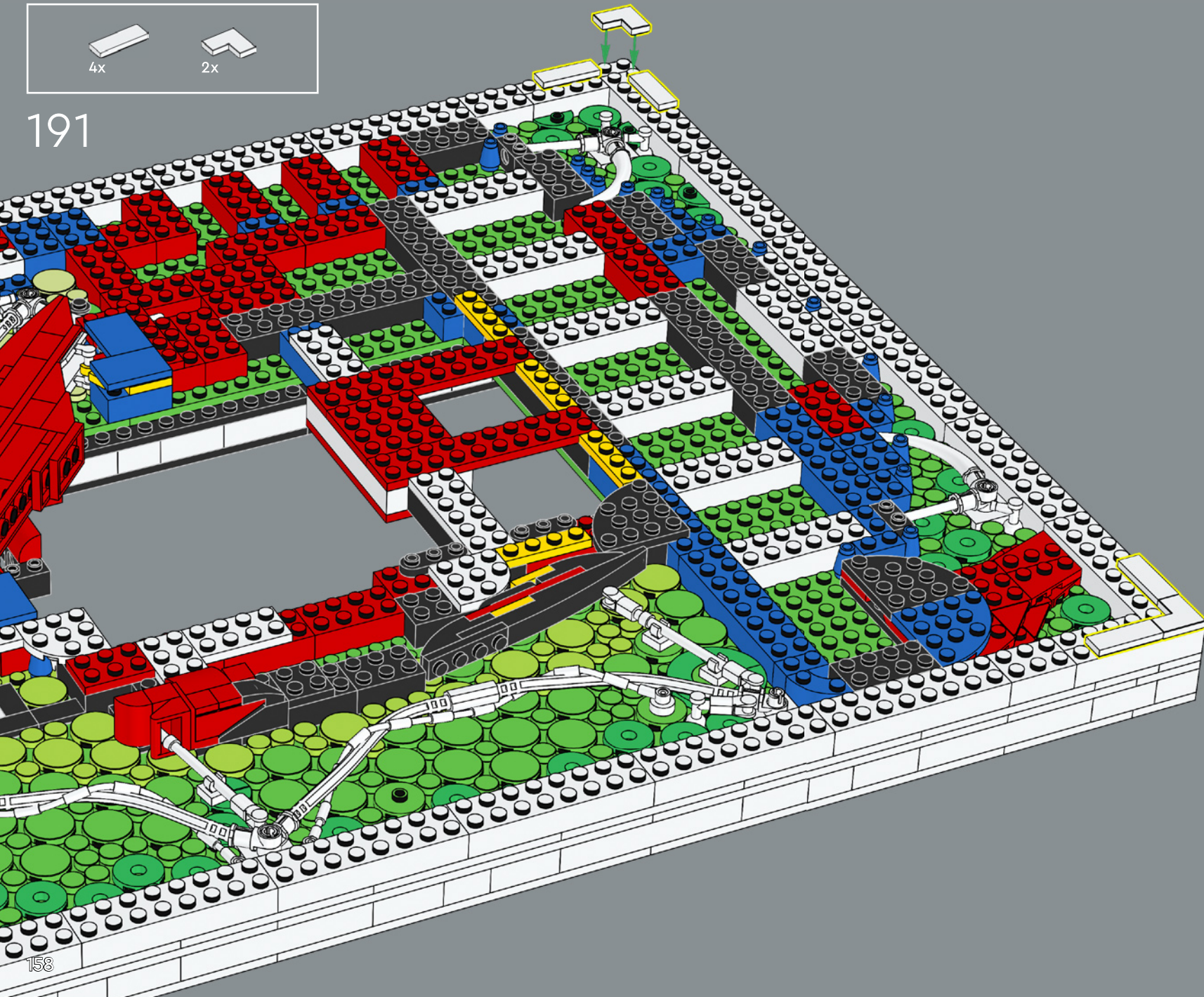

191

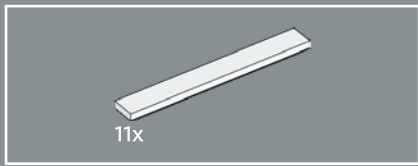

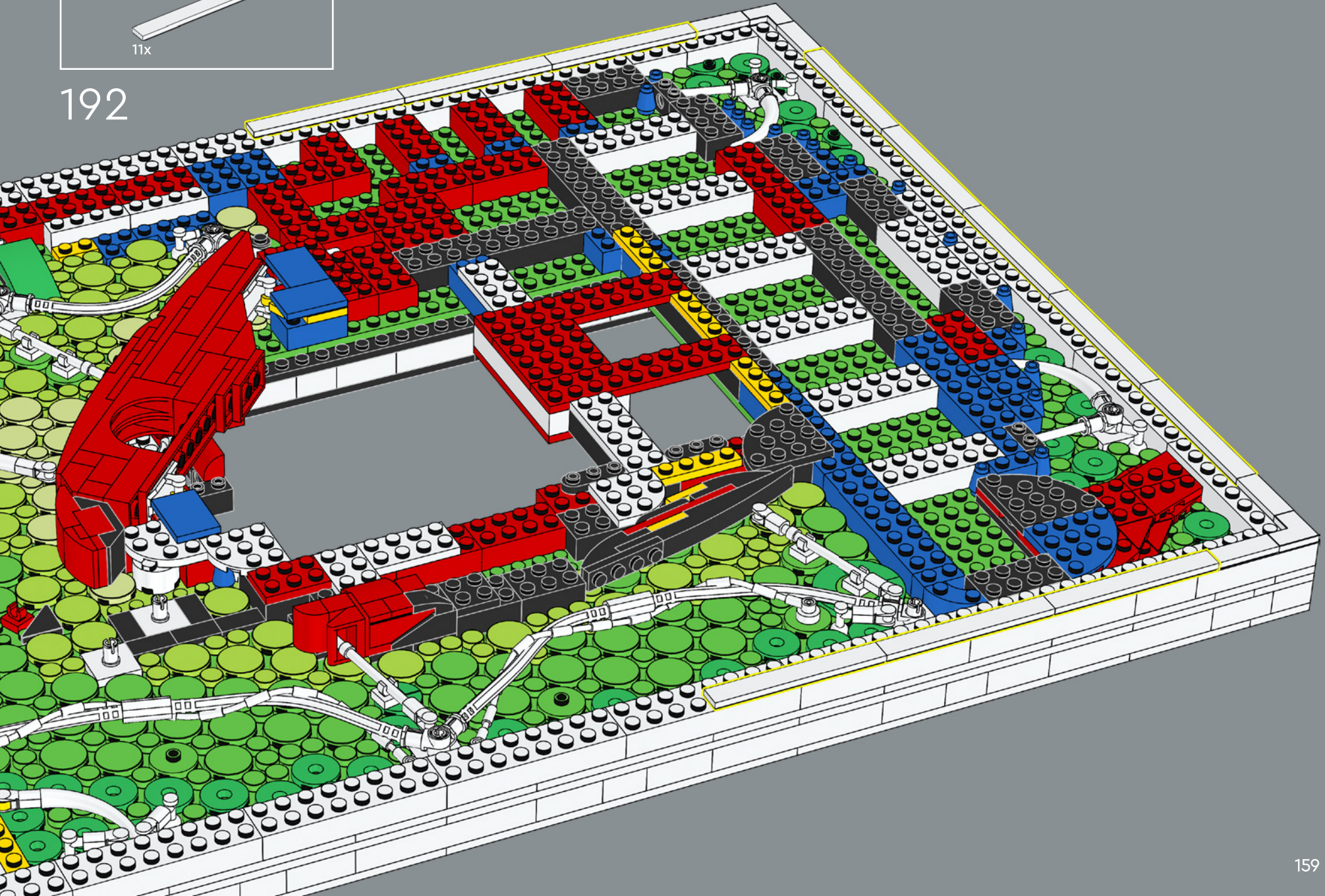

192



4x  2x 

193

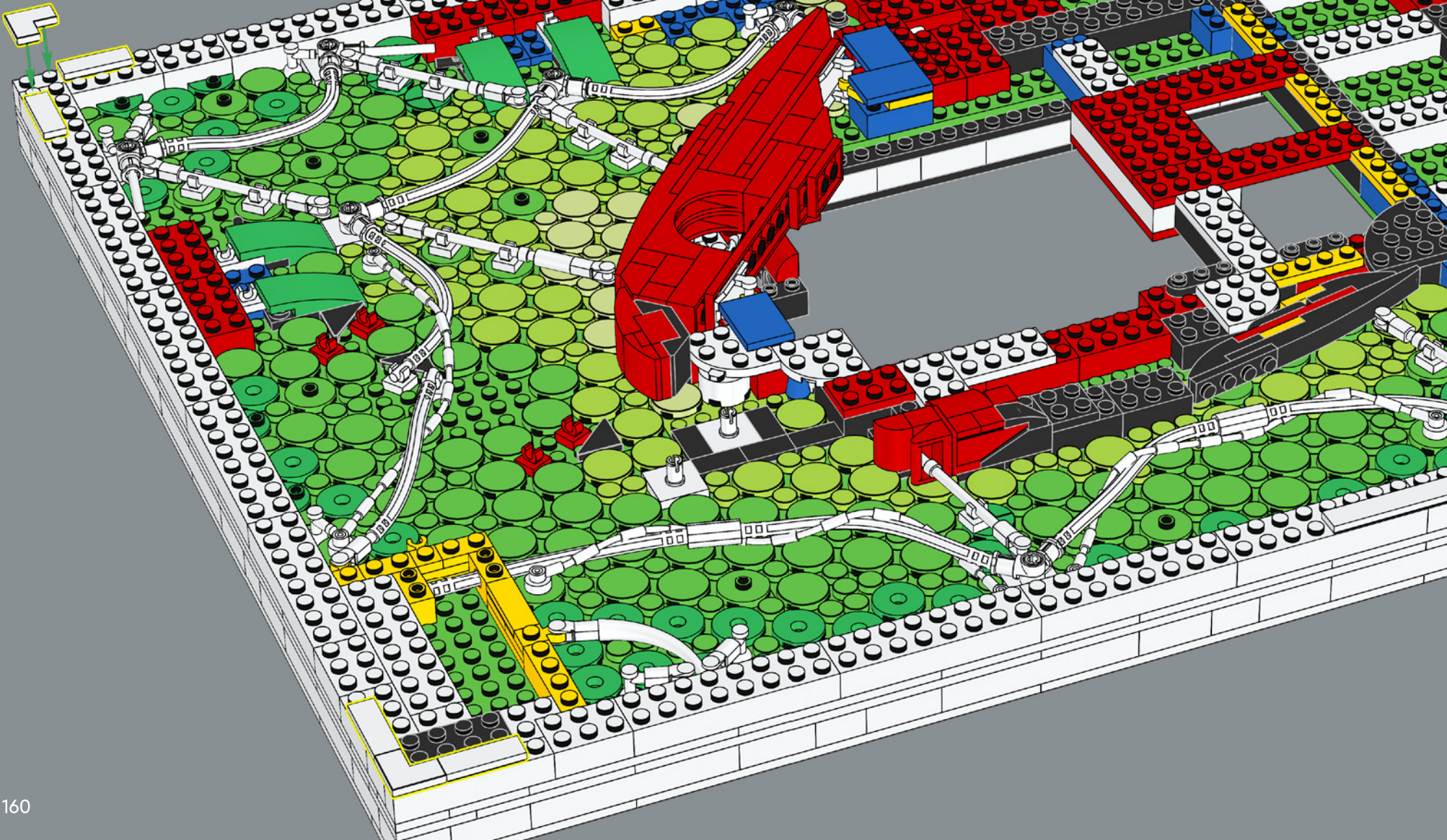

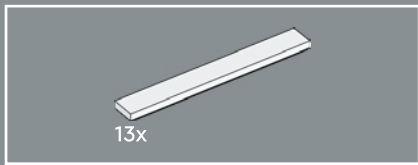

194

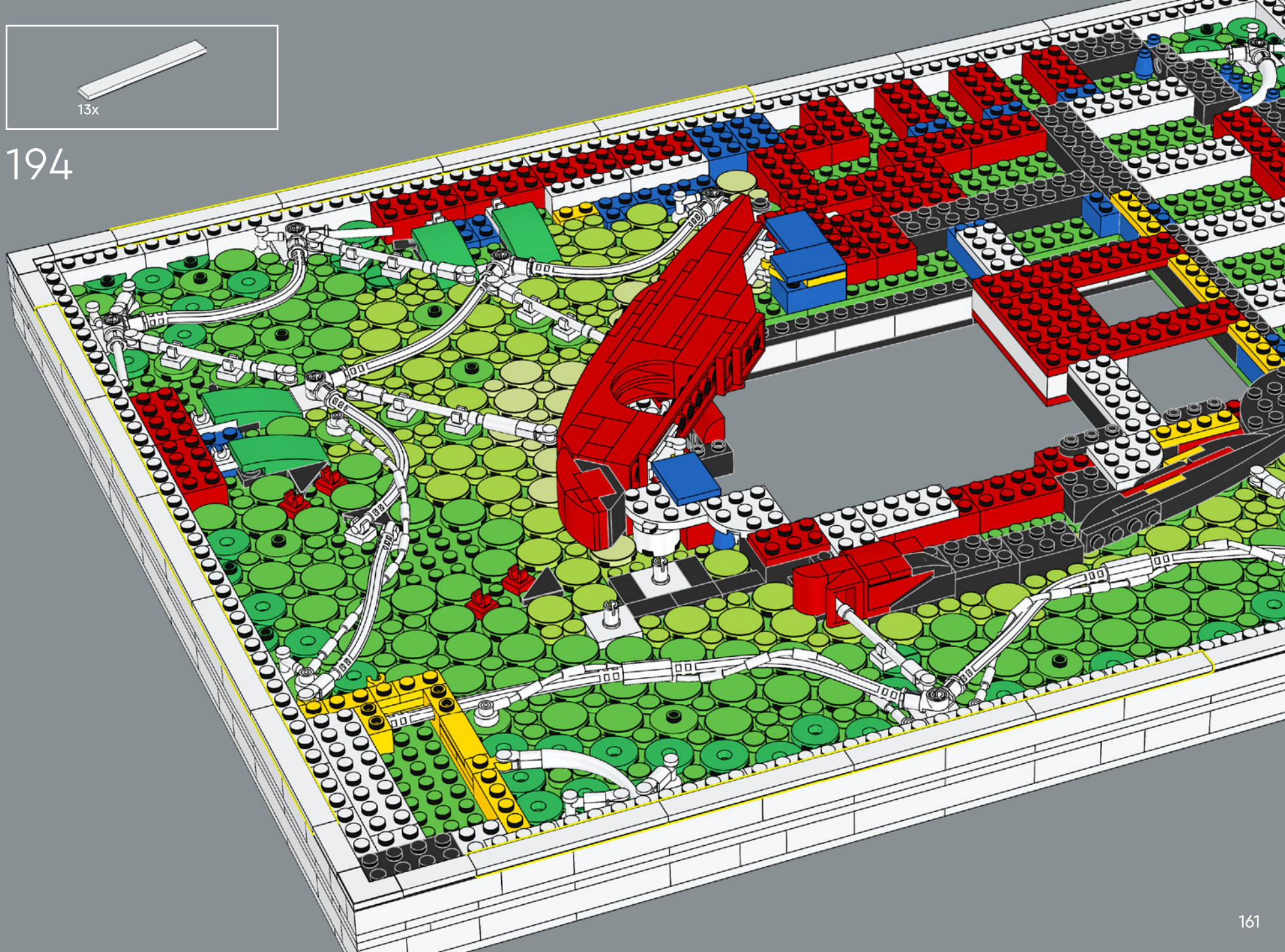

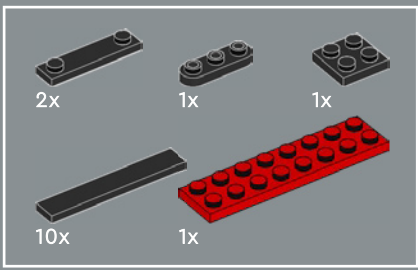

195

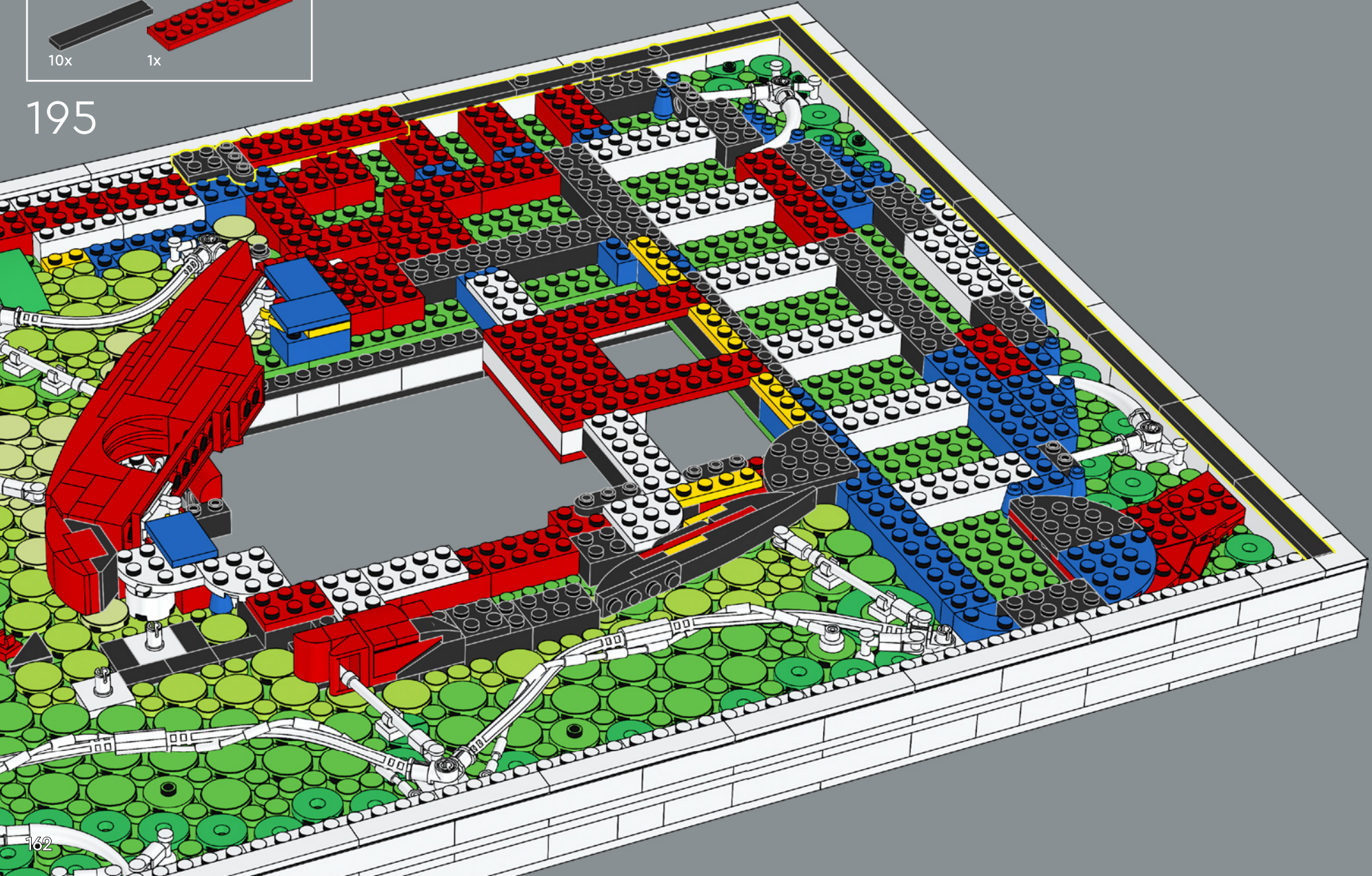

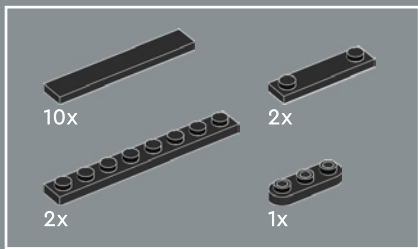

196

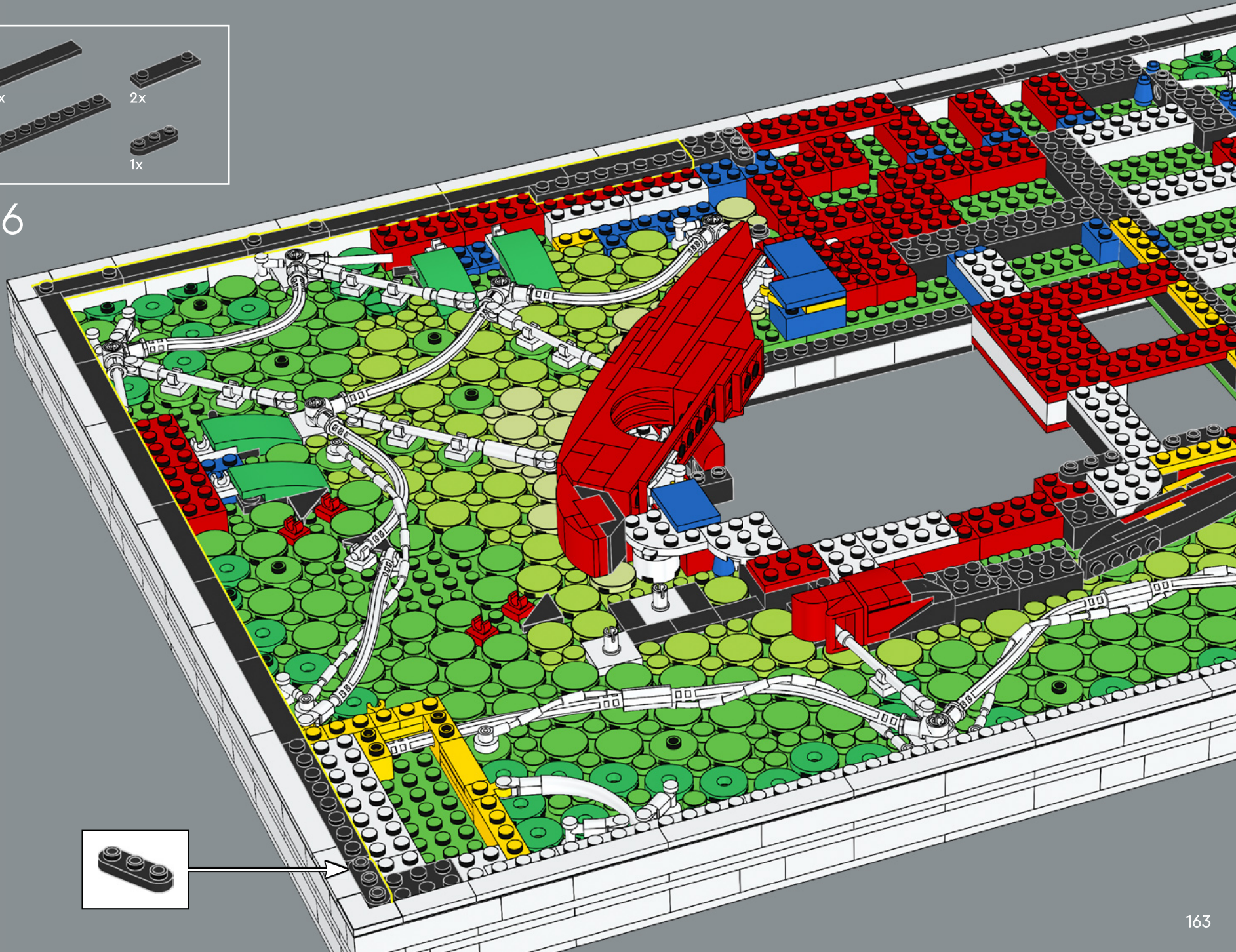

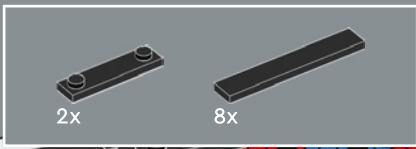

197

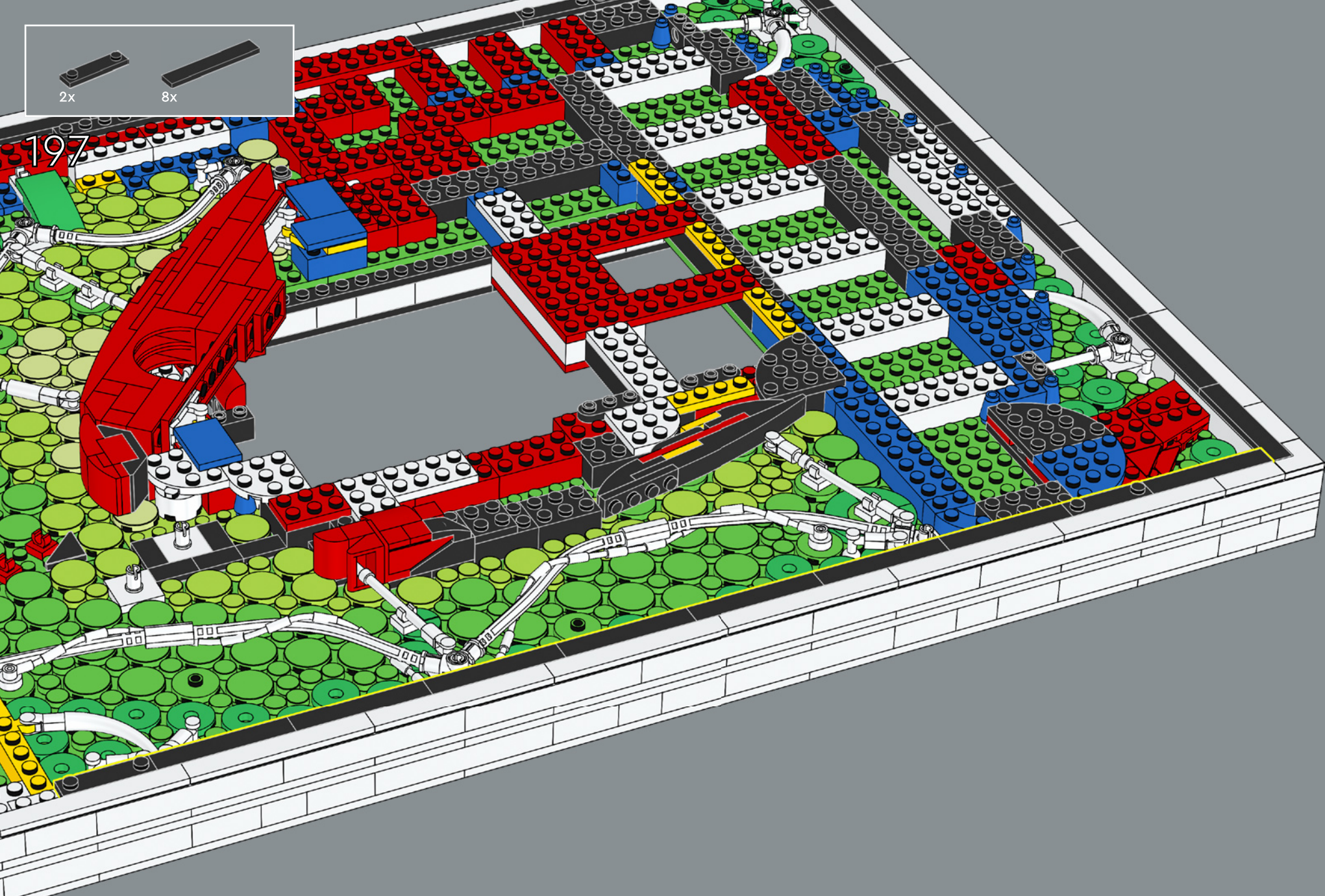

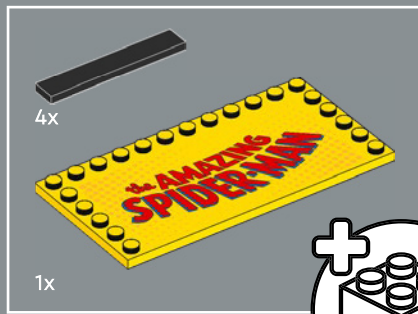

198

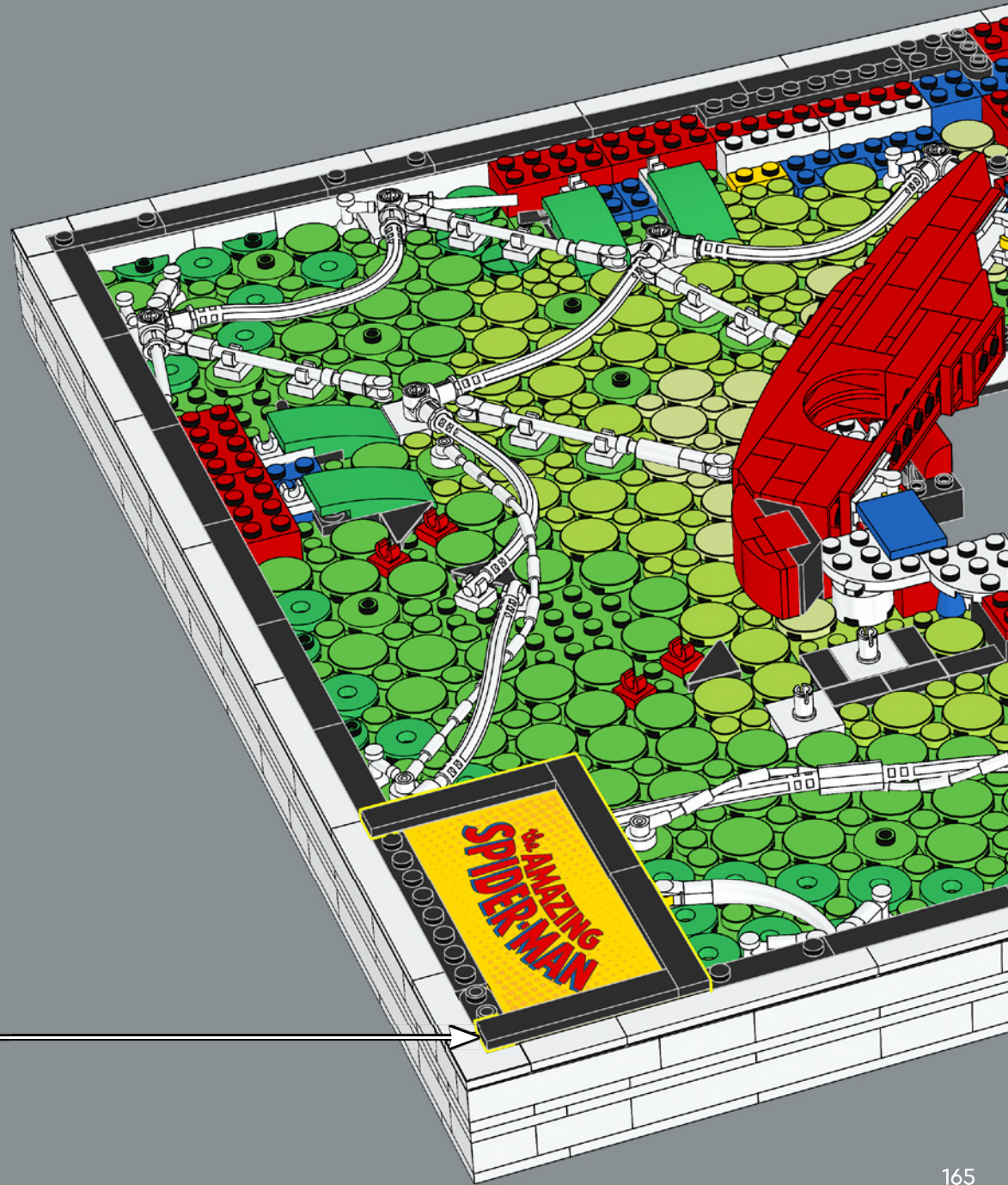
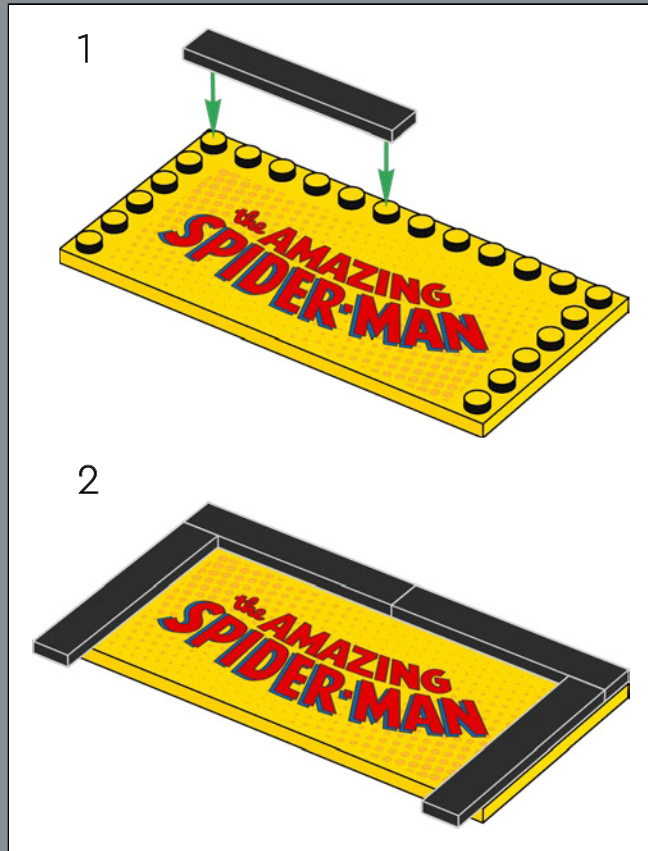
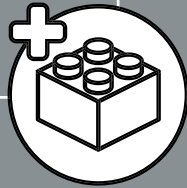

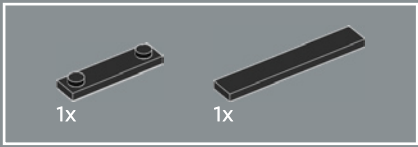

199

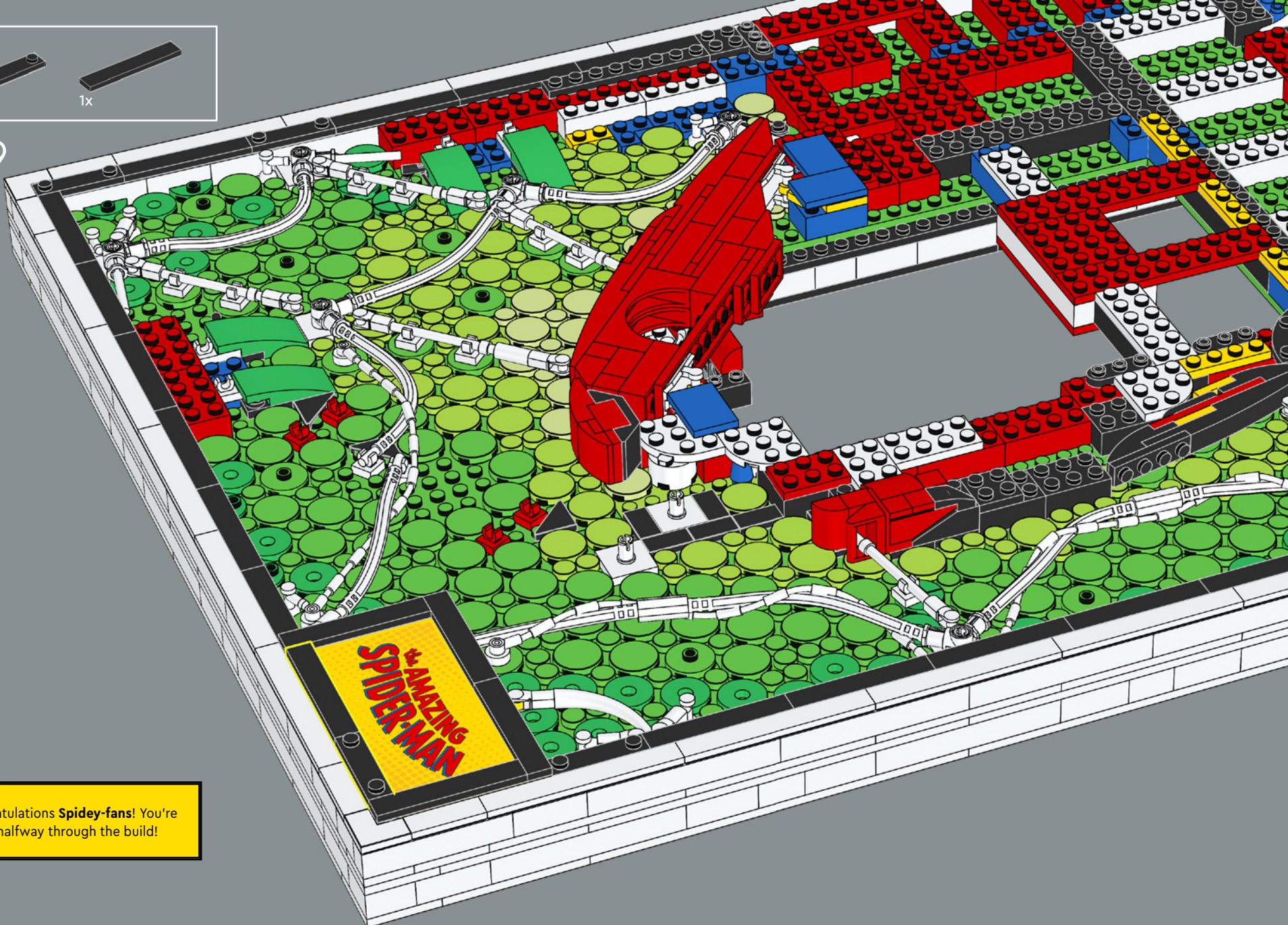

Congratulations **Spidey-fans!** You're about halfway through the build!



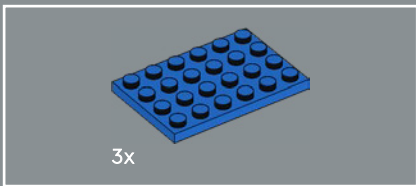

200

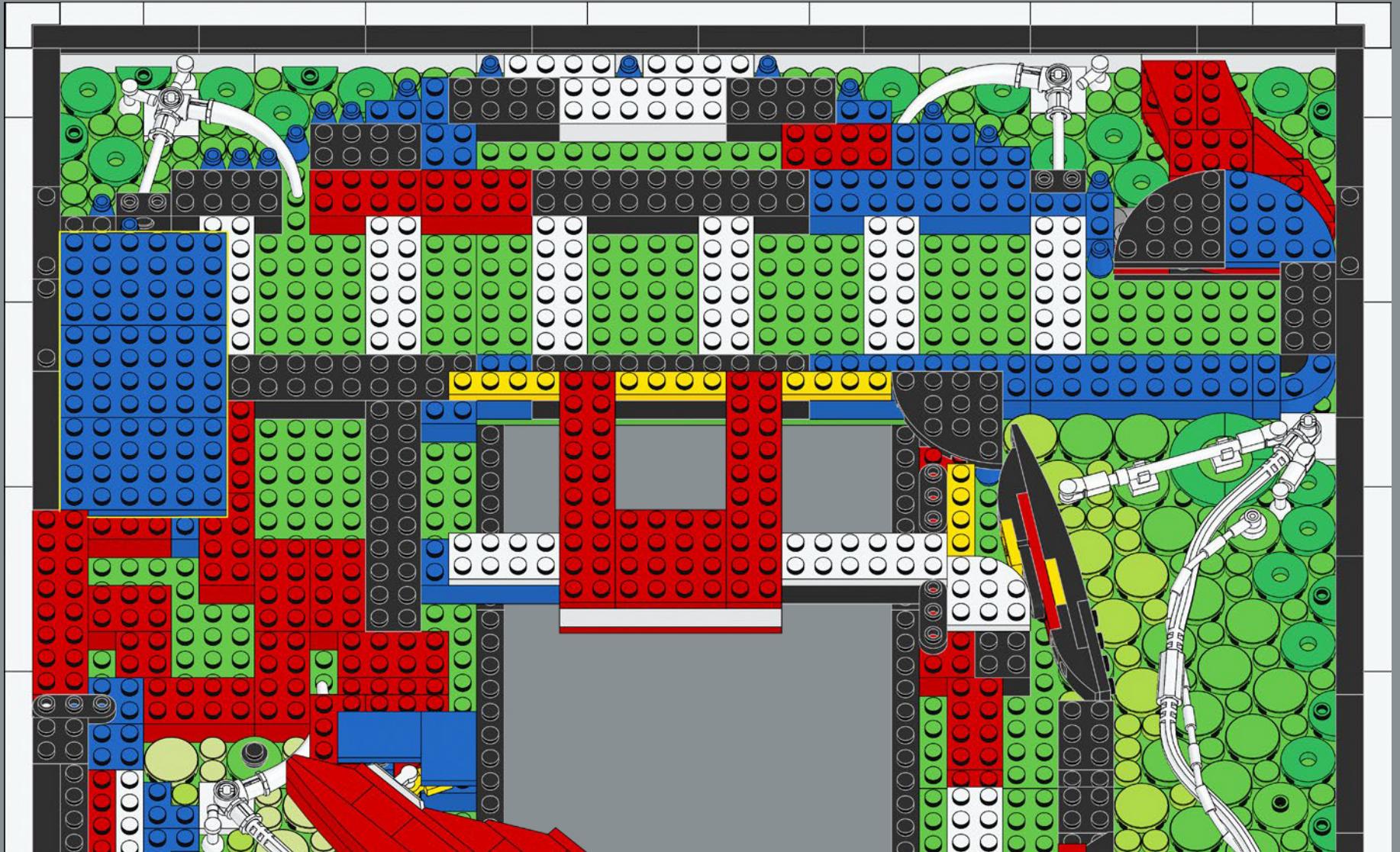



5x

201

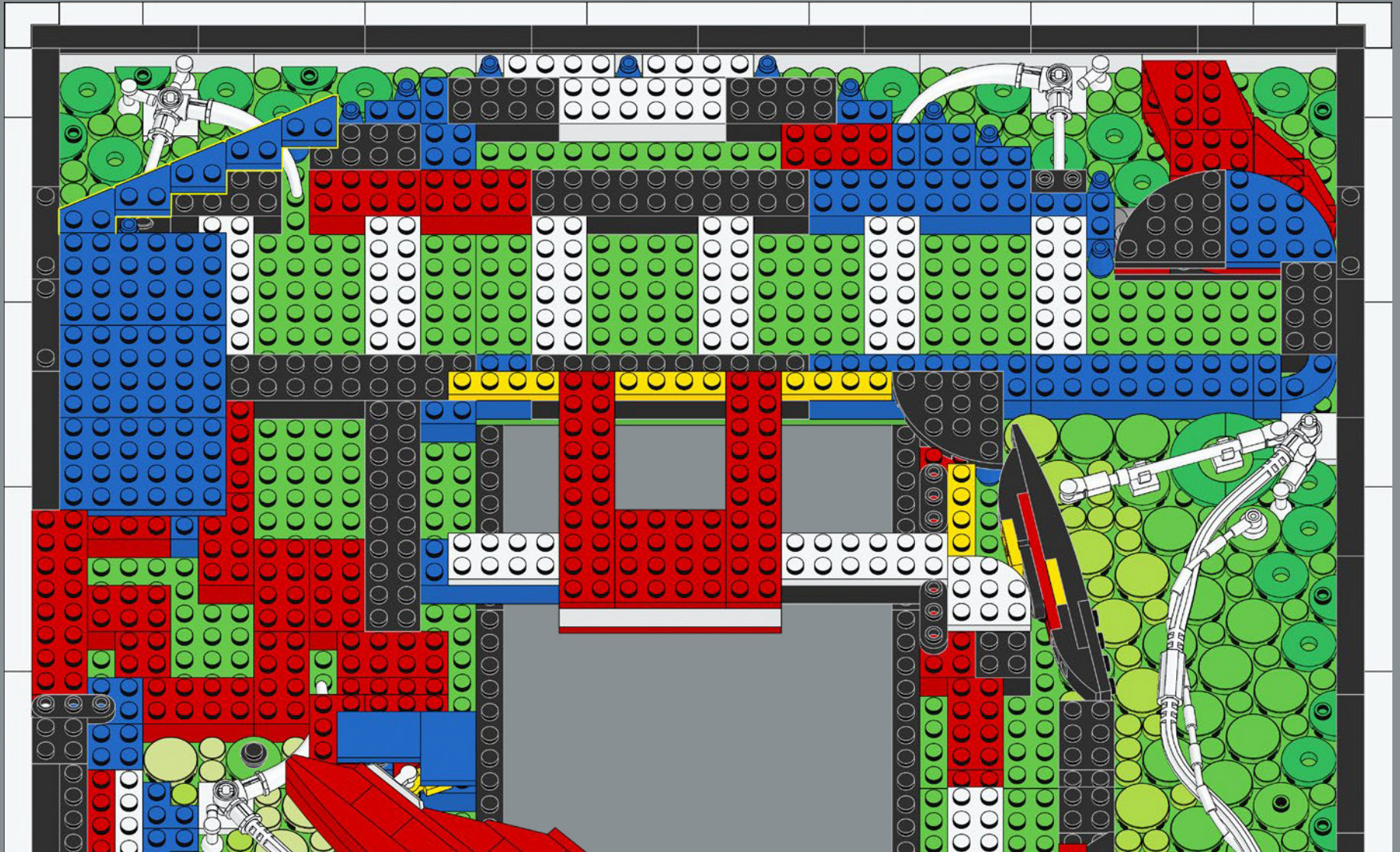

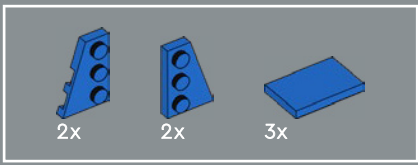

202

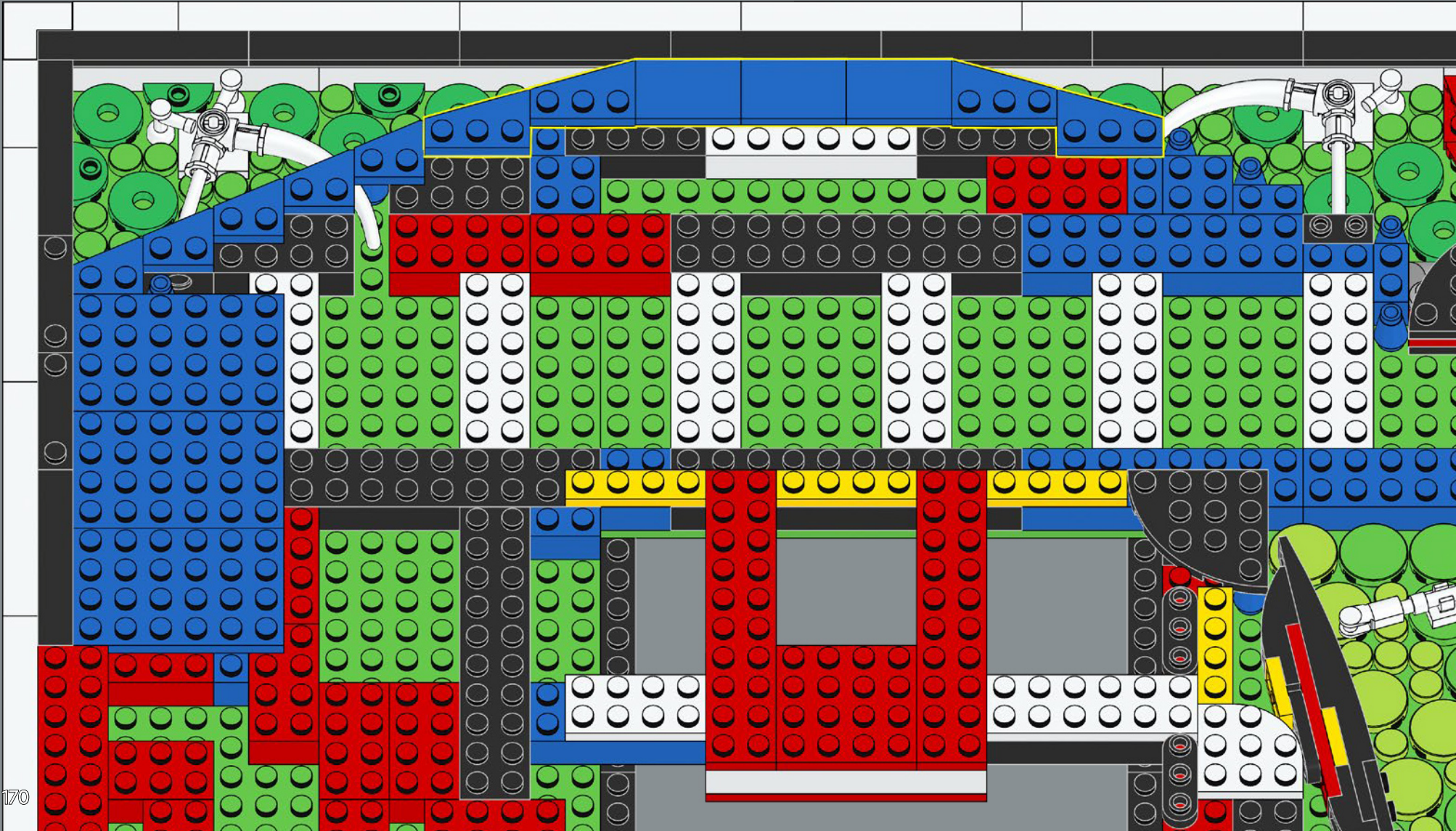

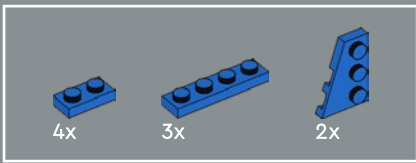

203

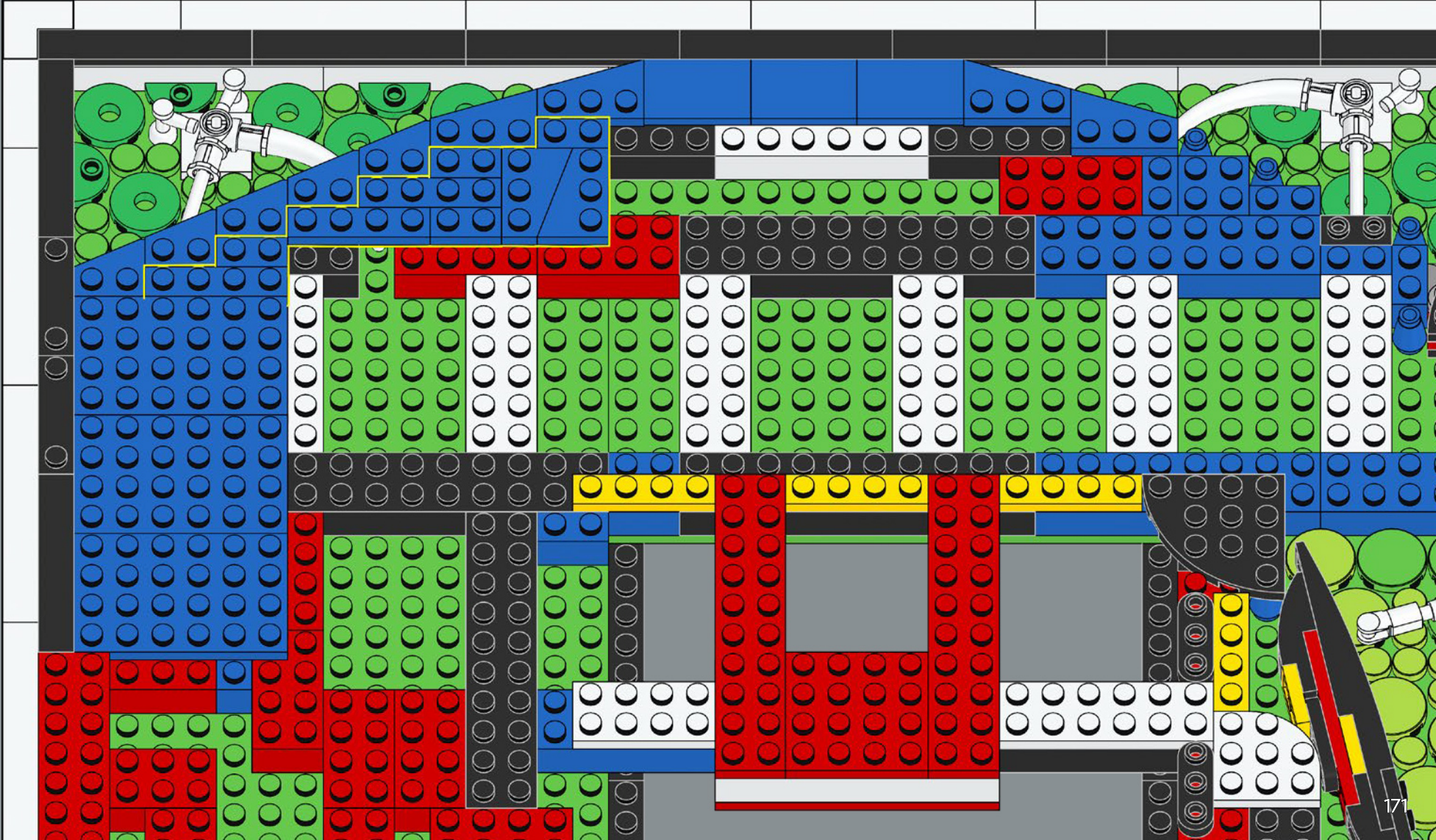

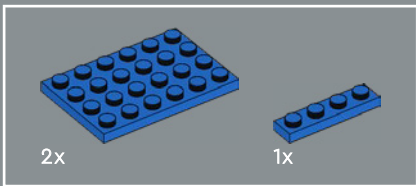

204

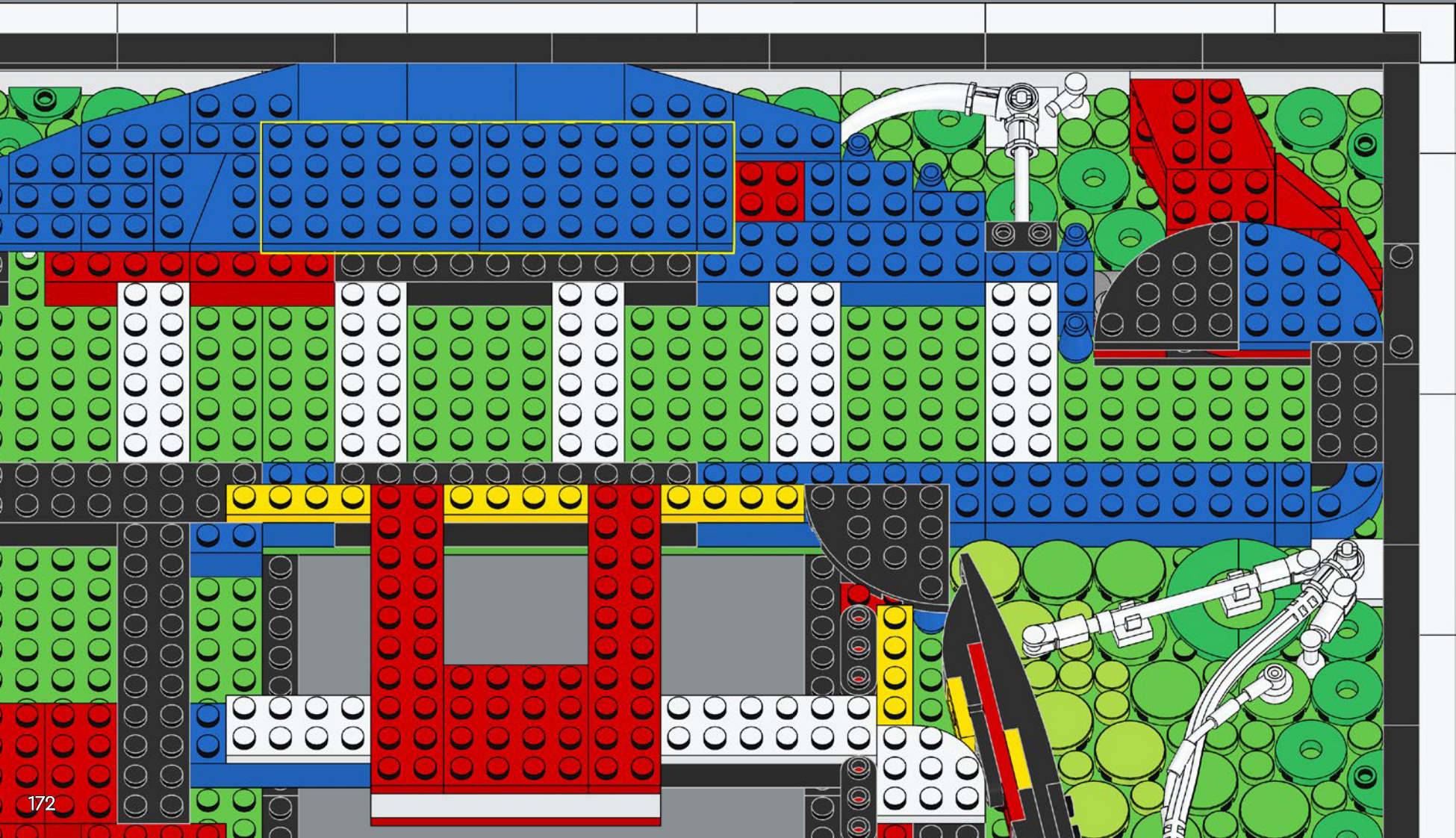

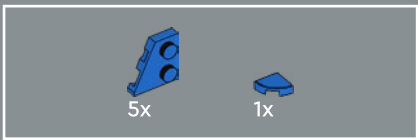

205

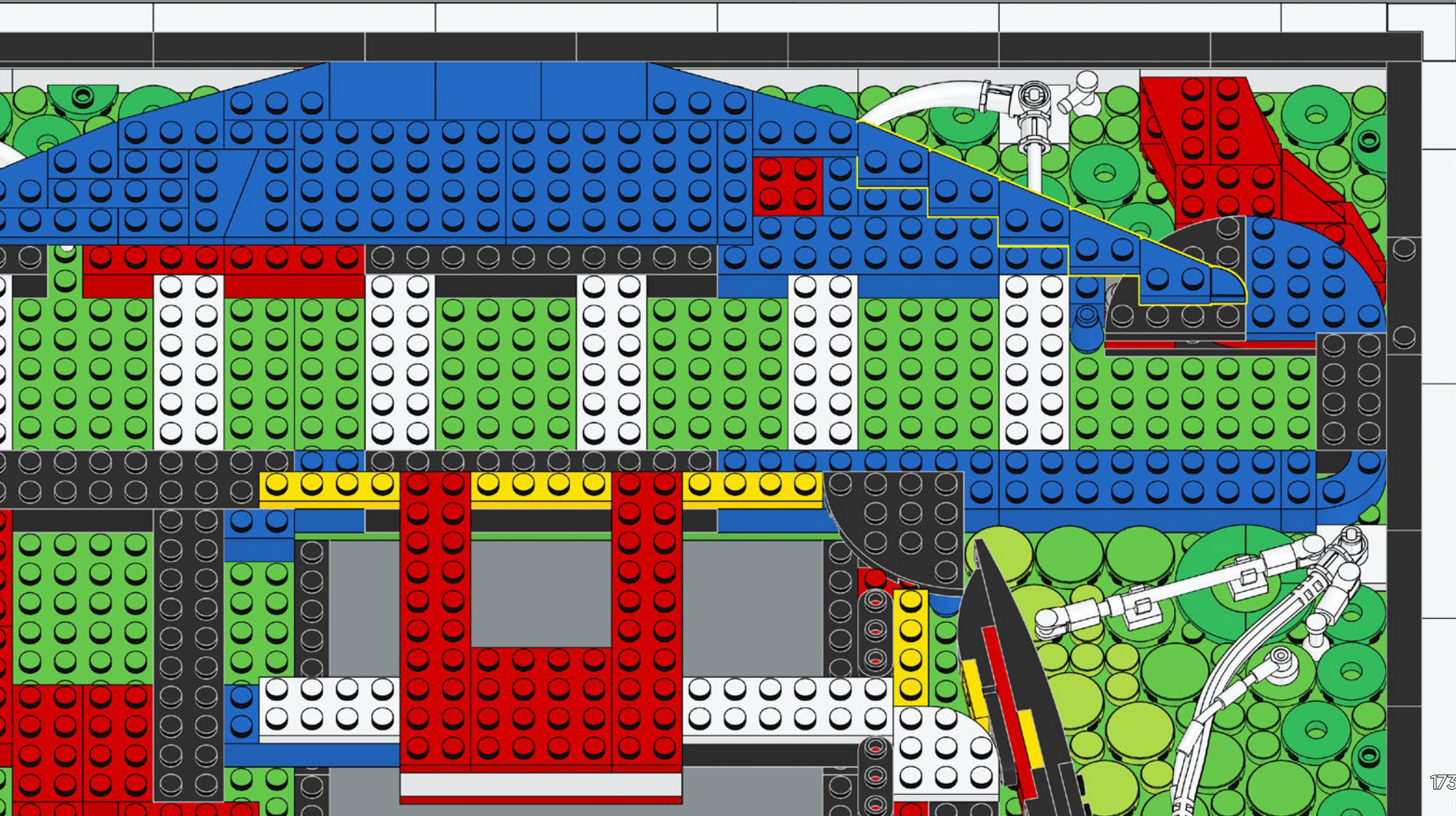

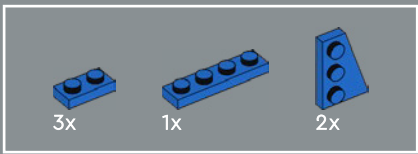

206

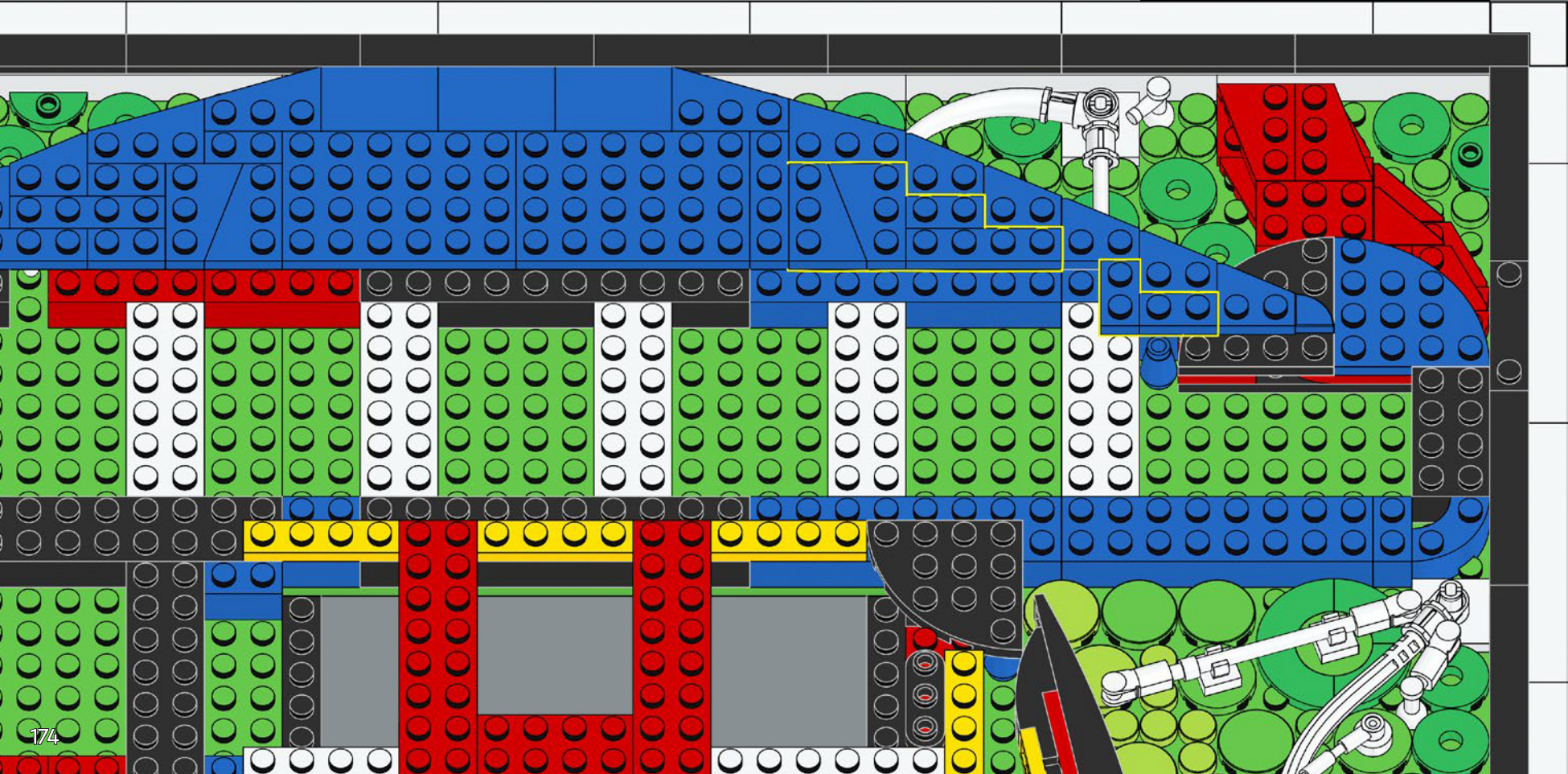

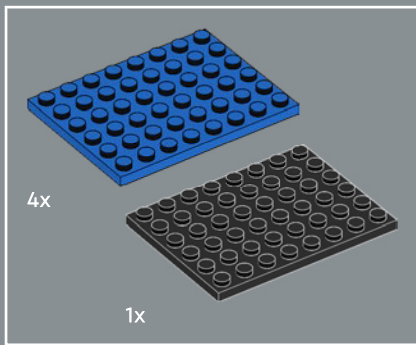

207

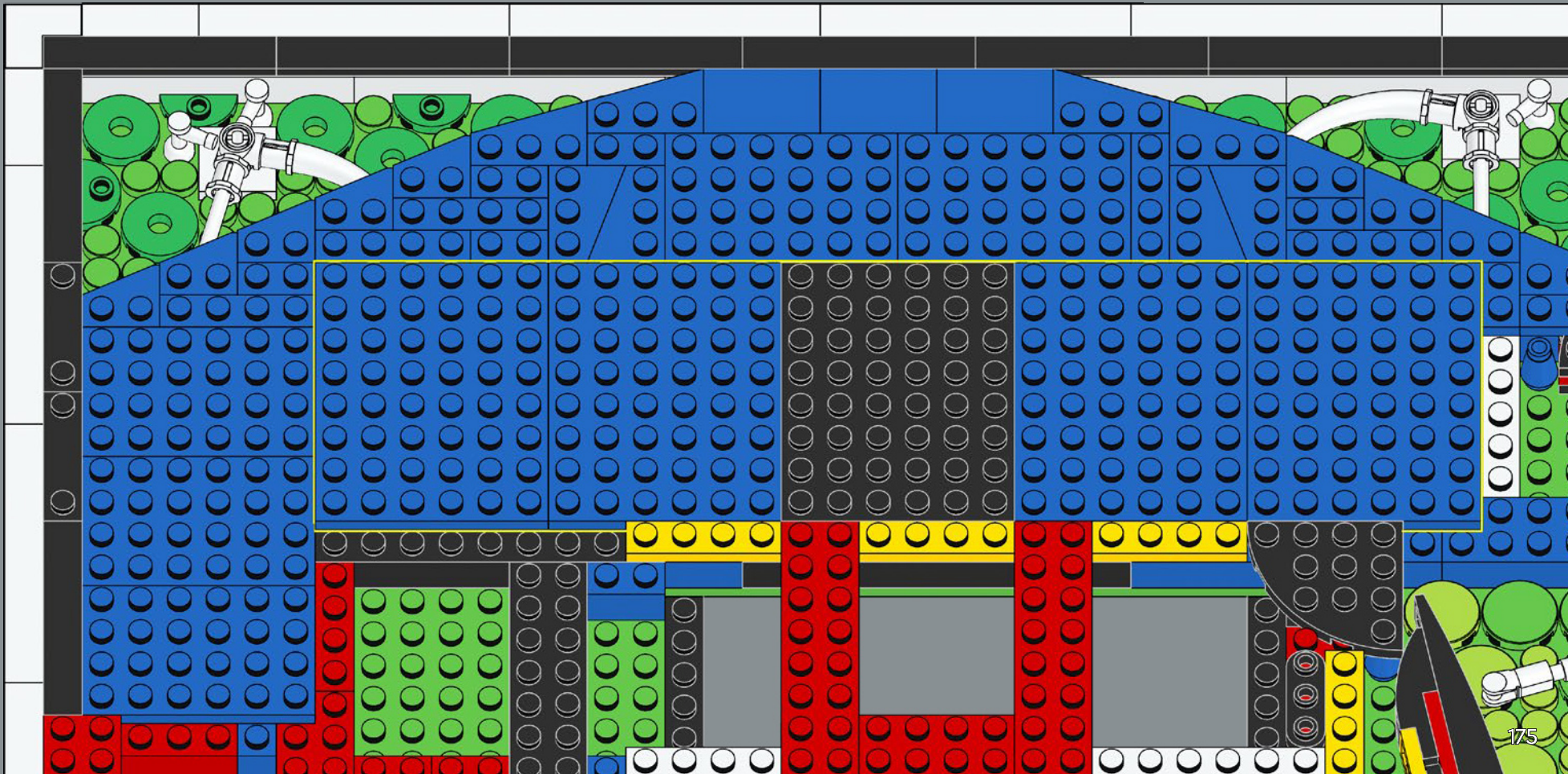

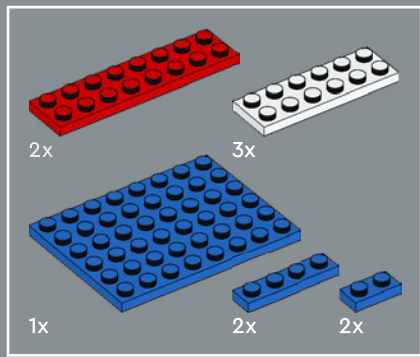

209

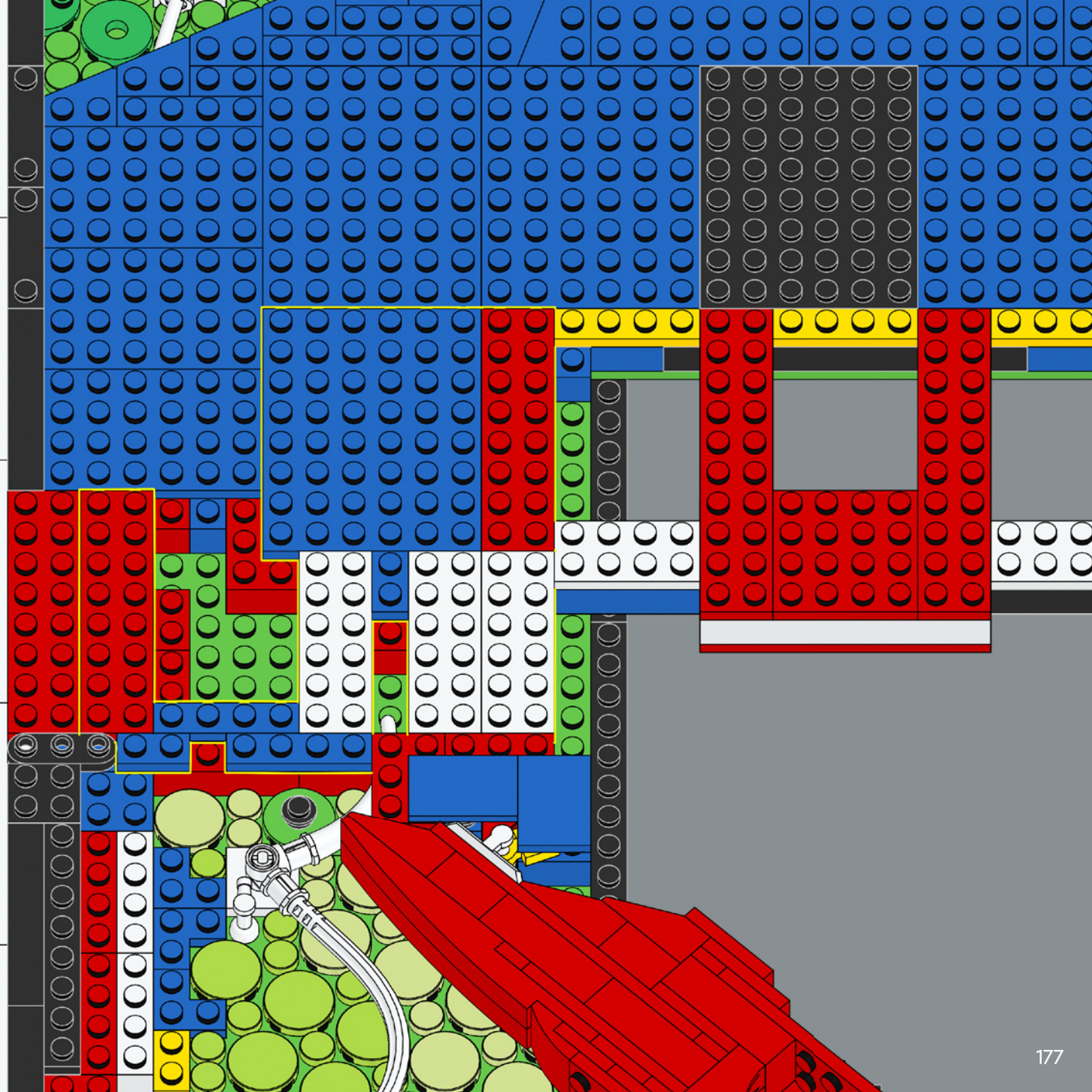

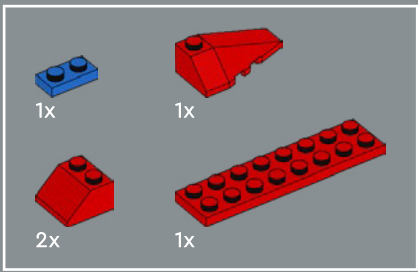

Did you know? Spider-Man was originally intended to have an **orange and purple costume**, but it was switched to the iconic **red and blue** because it would print cleaner on pulp paper.

210

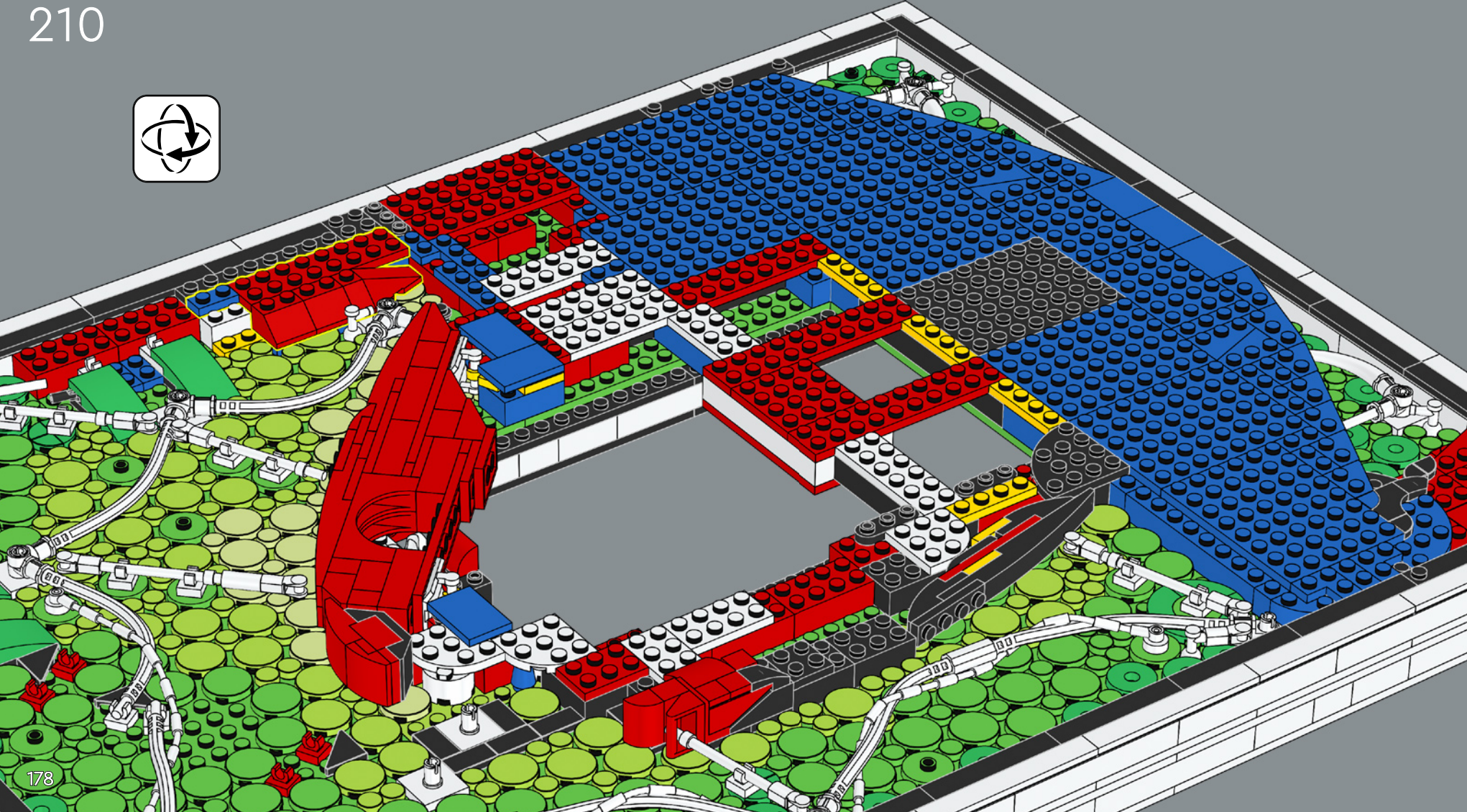

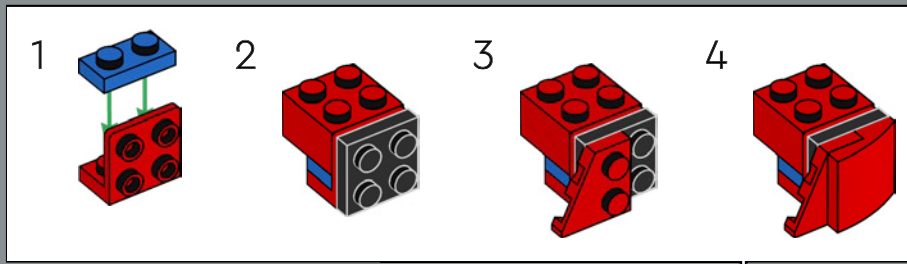
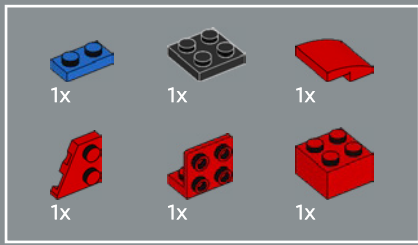

211

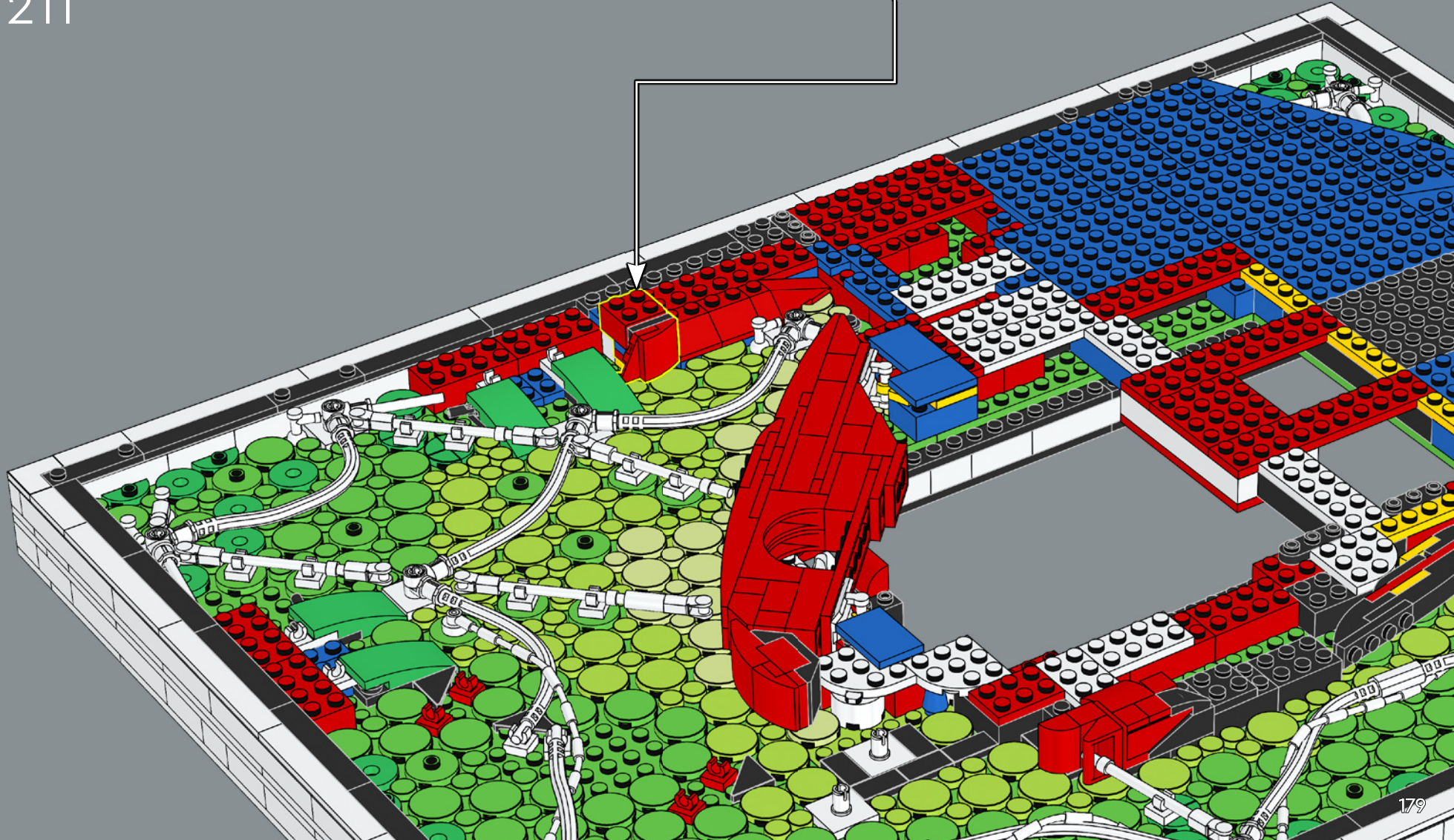

1x  1x 

212

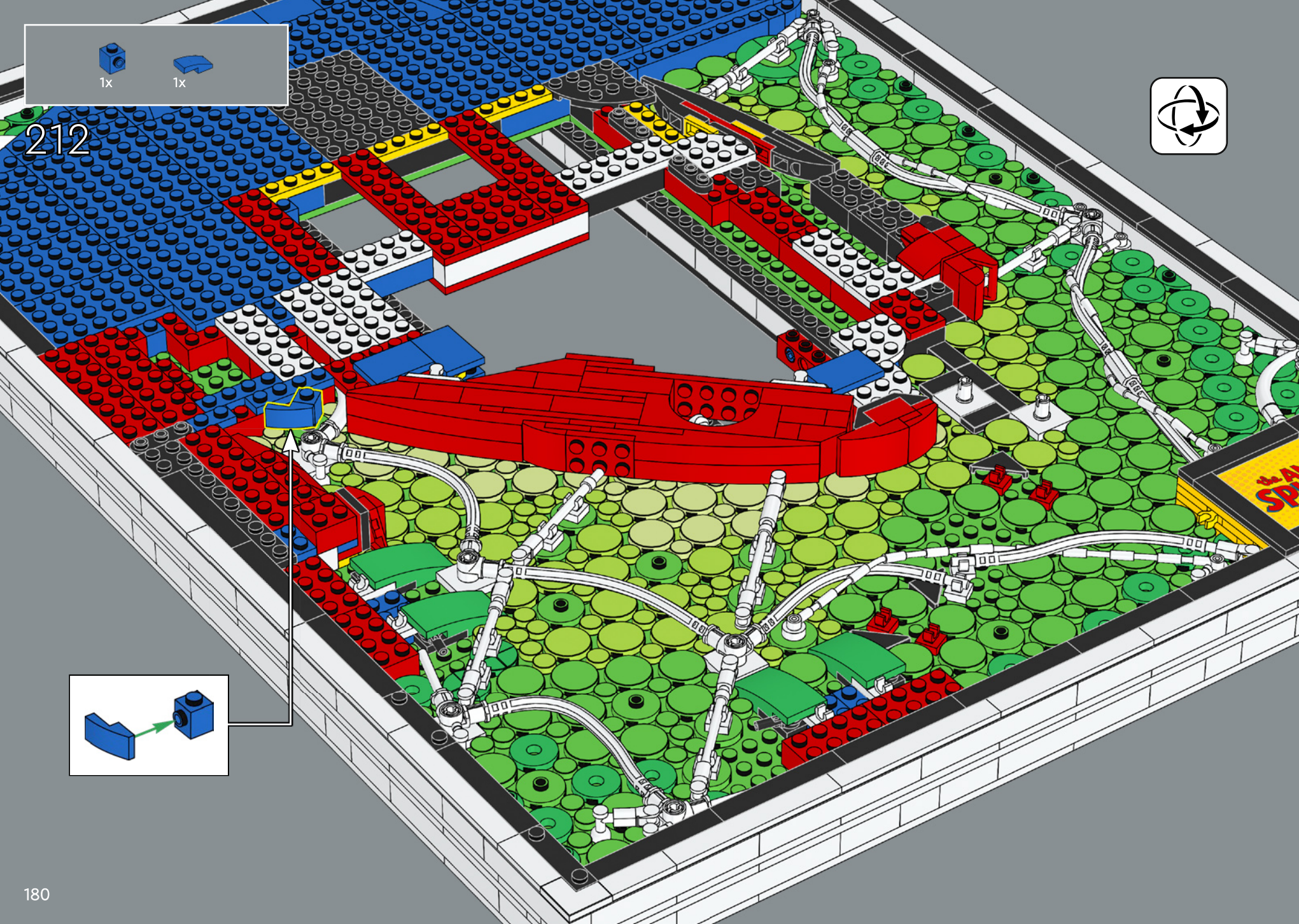
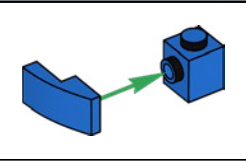

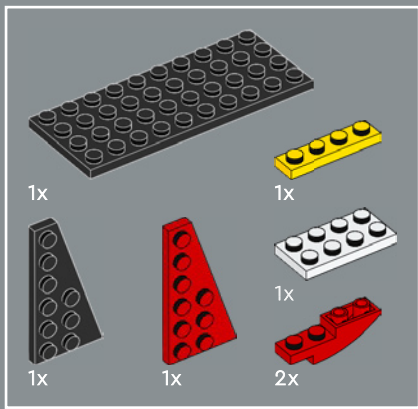

213

1

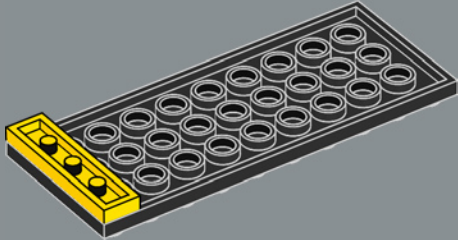

2

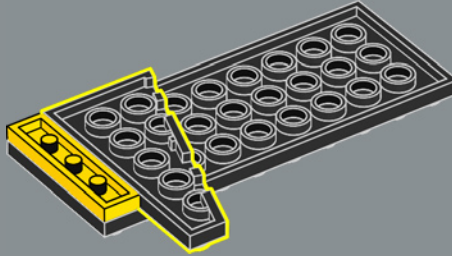

3

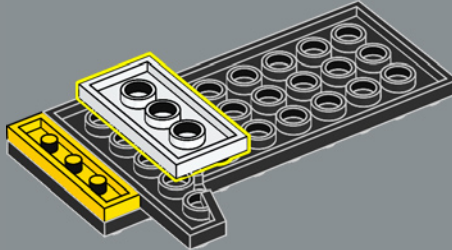

4

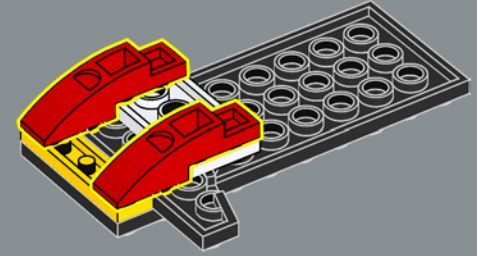

5

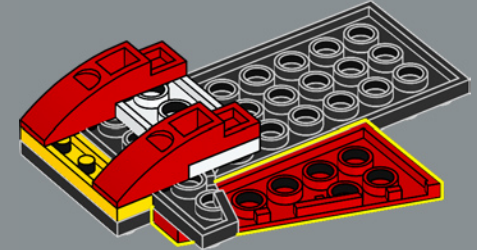

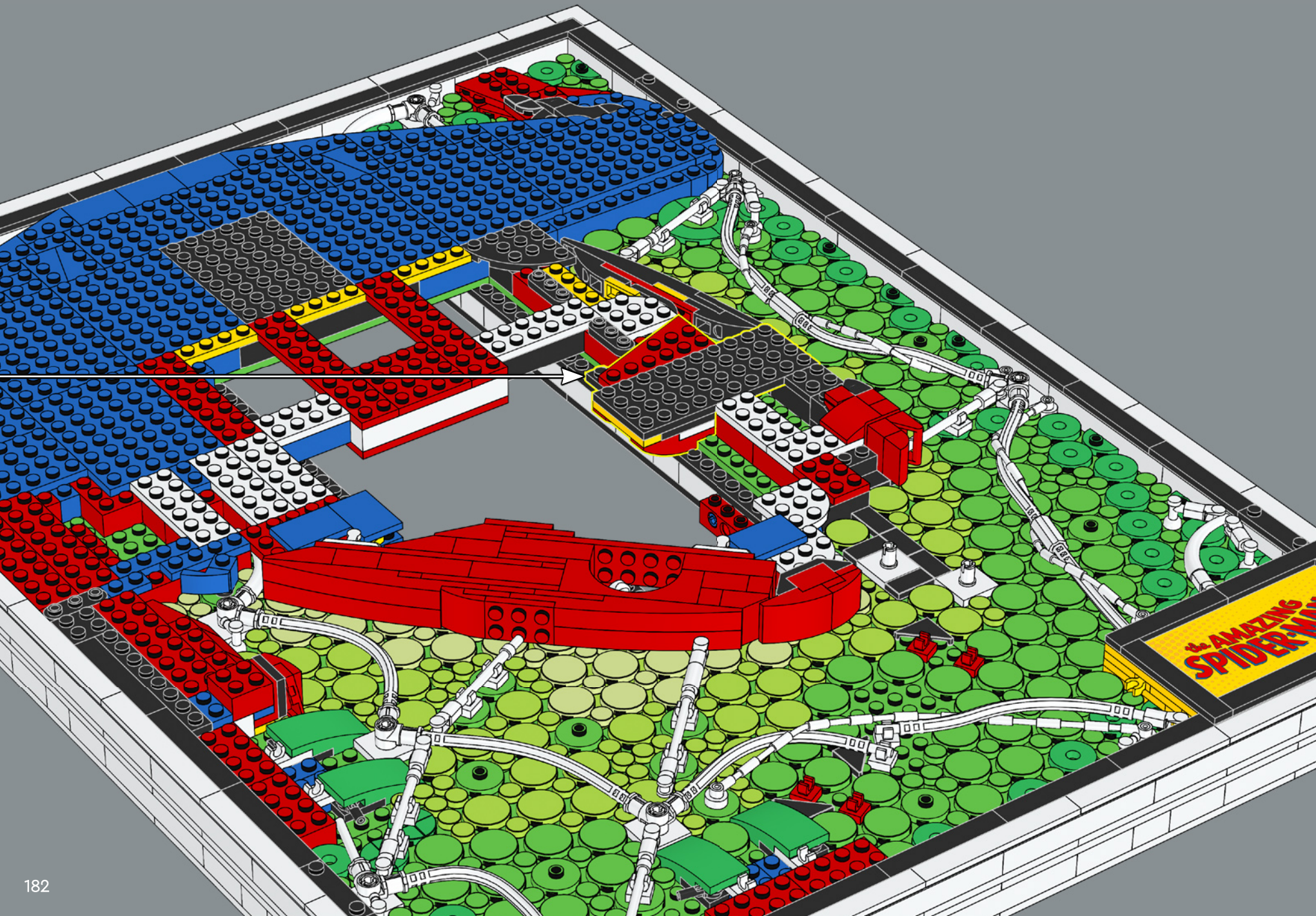

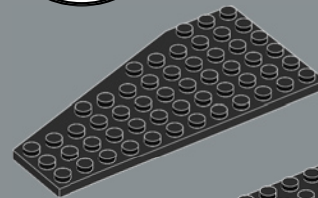
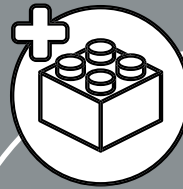

1x

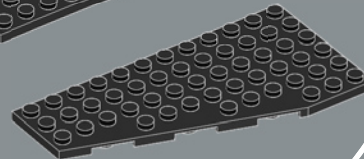

1x

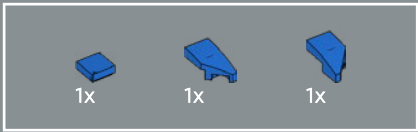

214

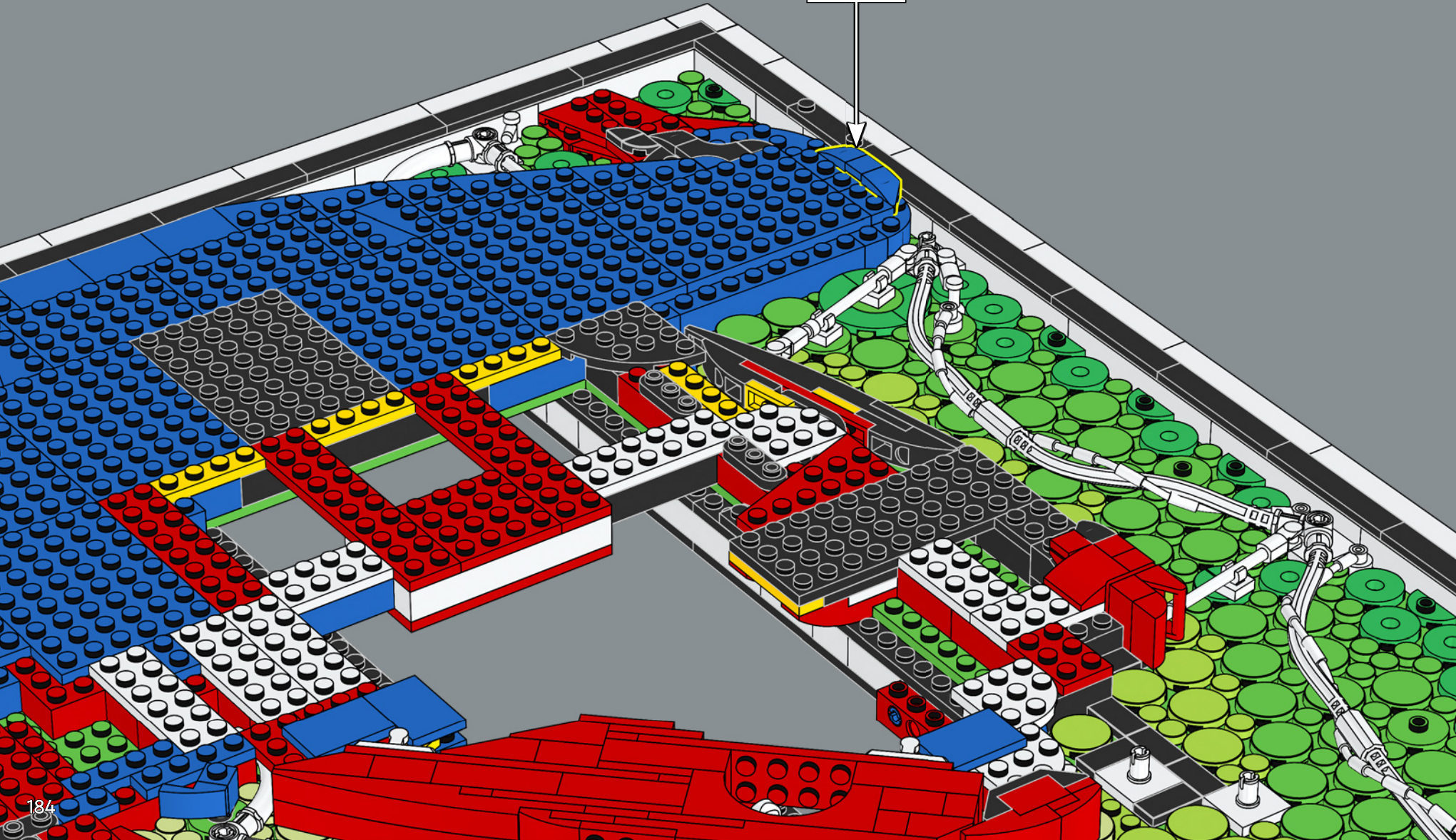

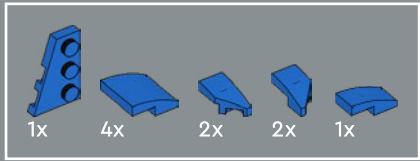

215

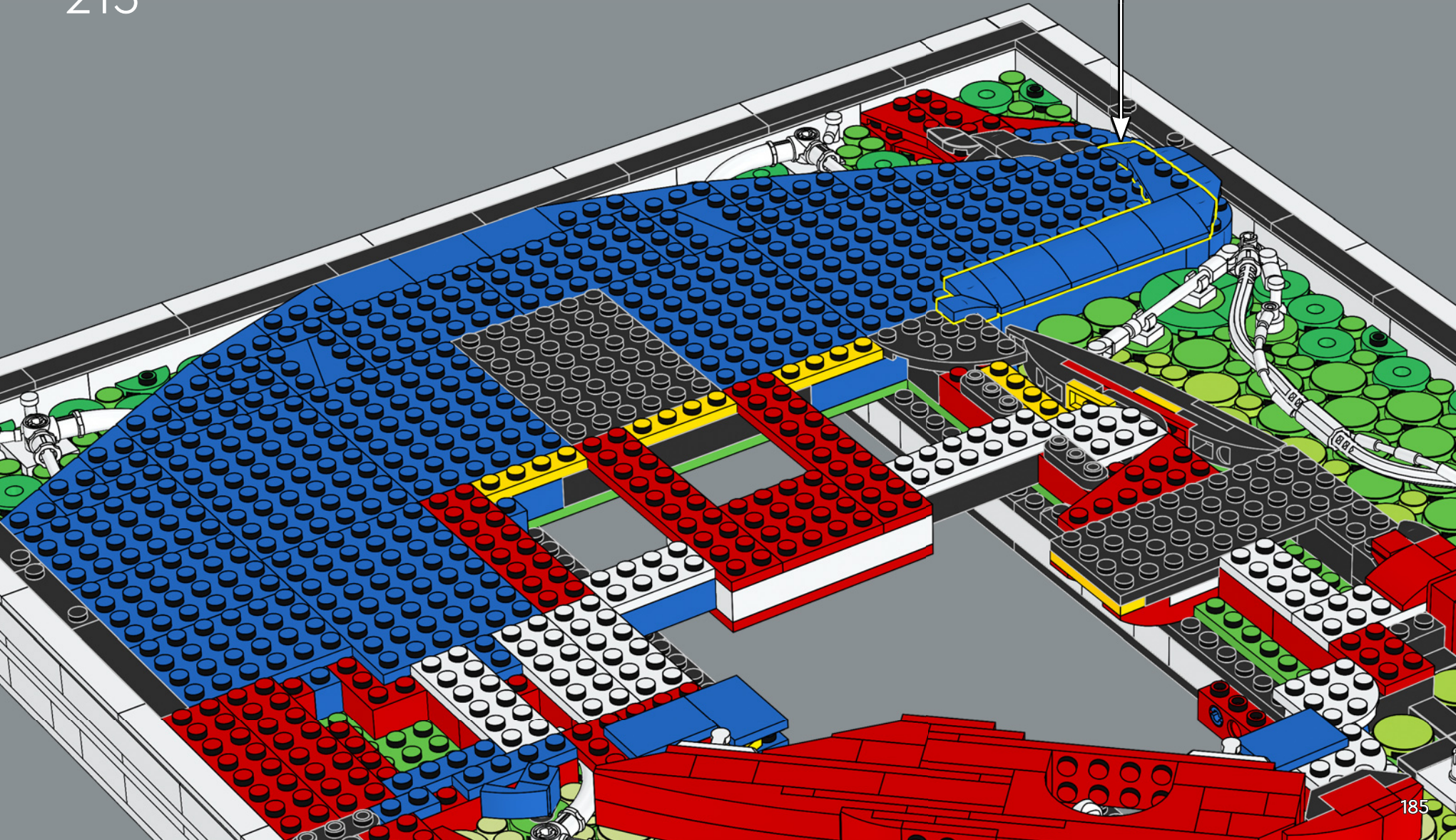
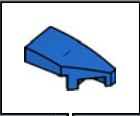

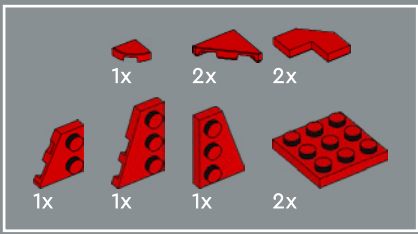

216

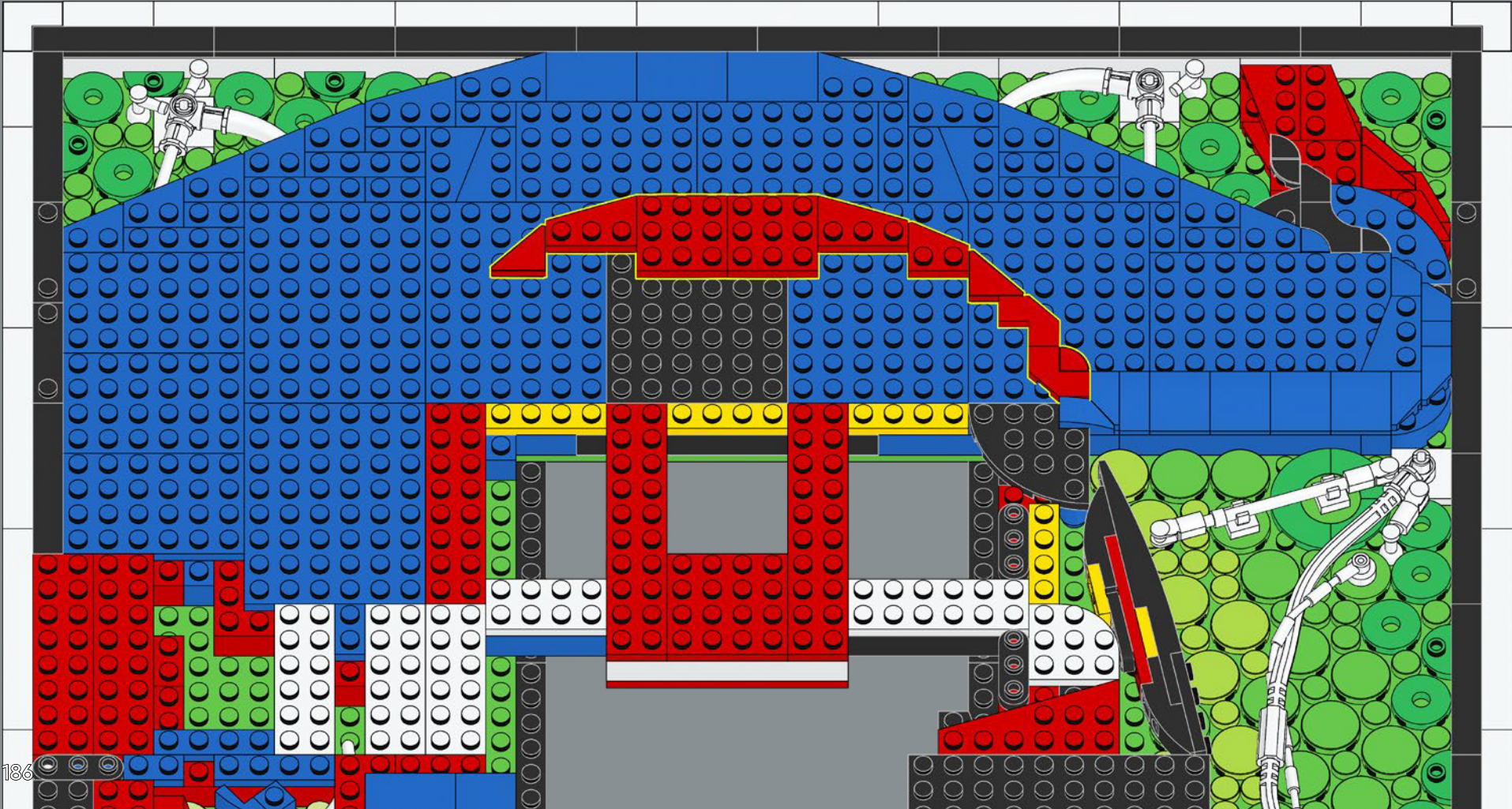

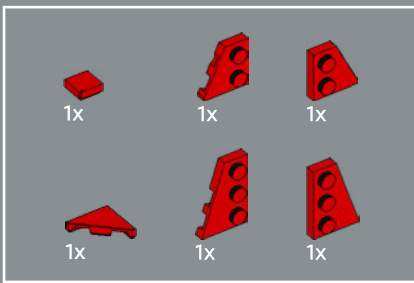

Did you know? Spider-Man stores extra web fluid cartridges on his belt. The actual belt is tucked beneath his costume, so they don't get lost!

217

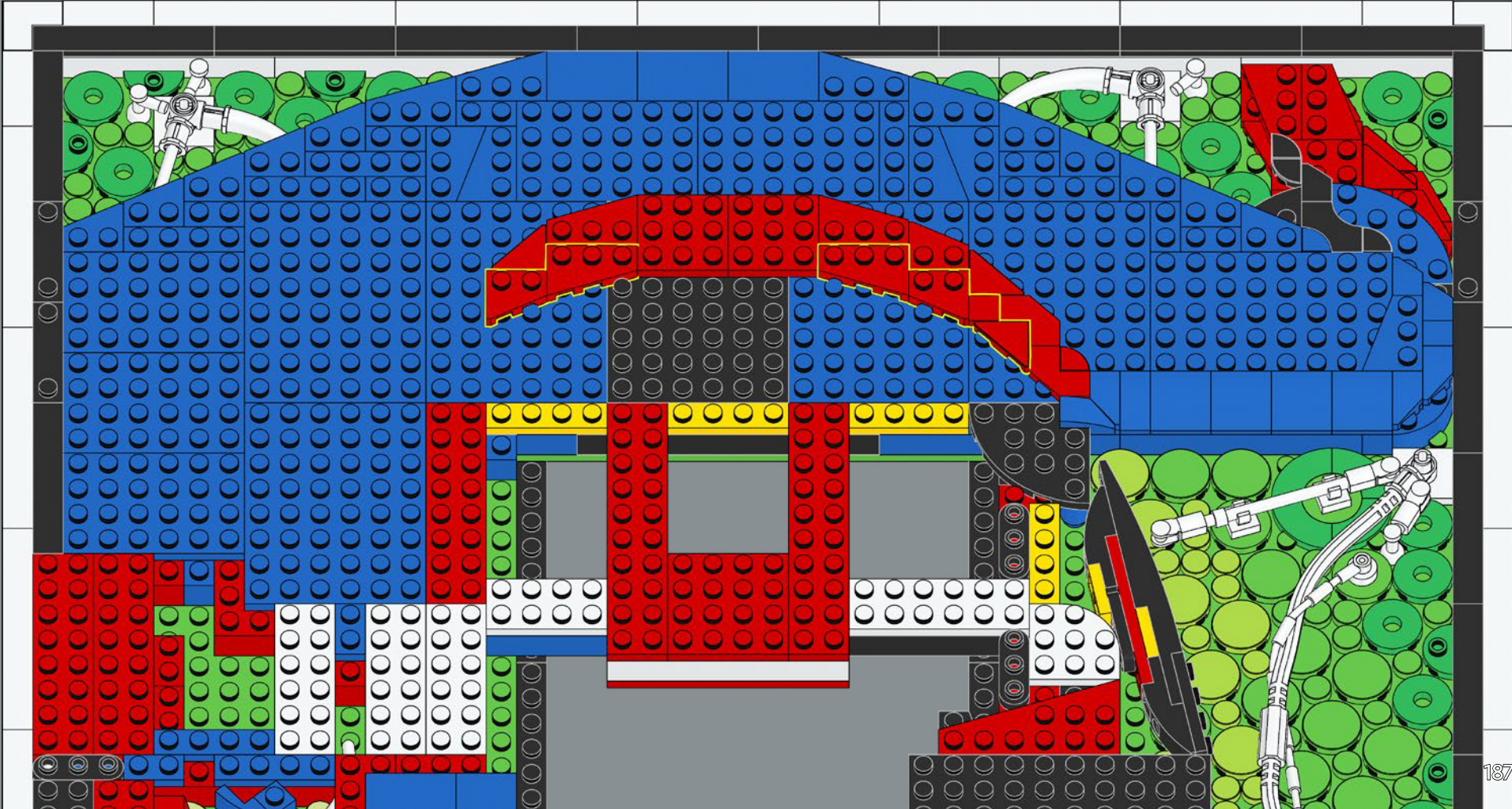

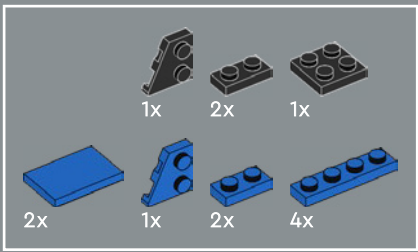

220

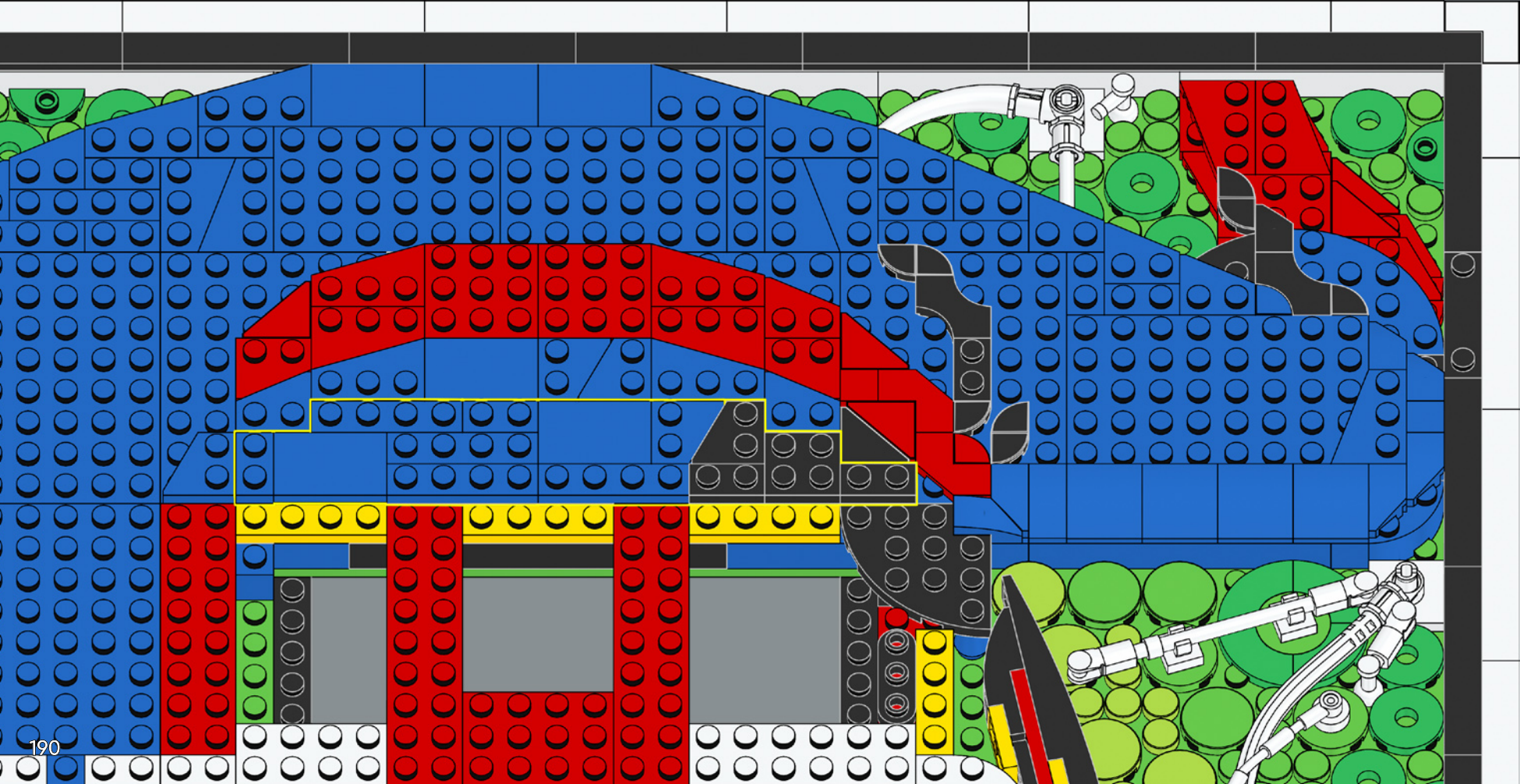

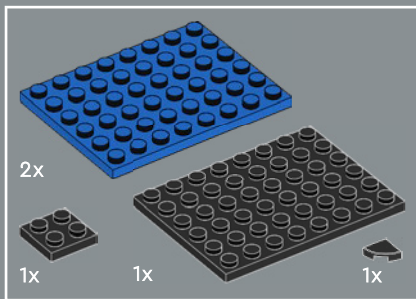

221

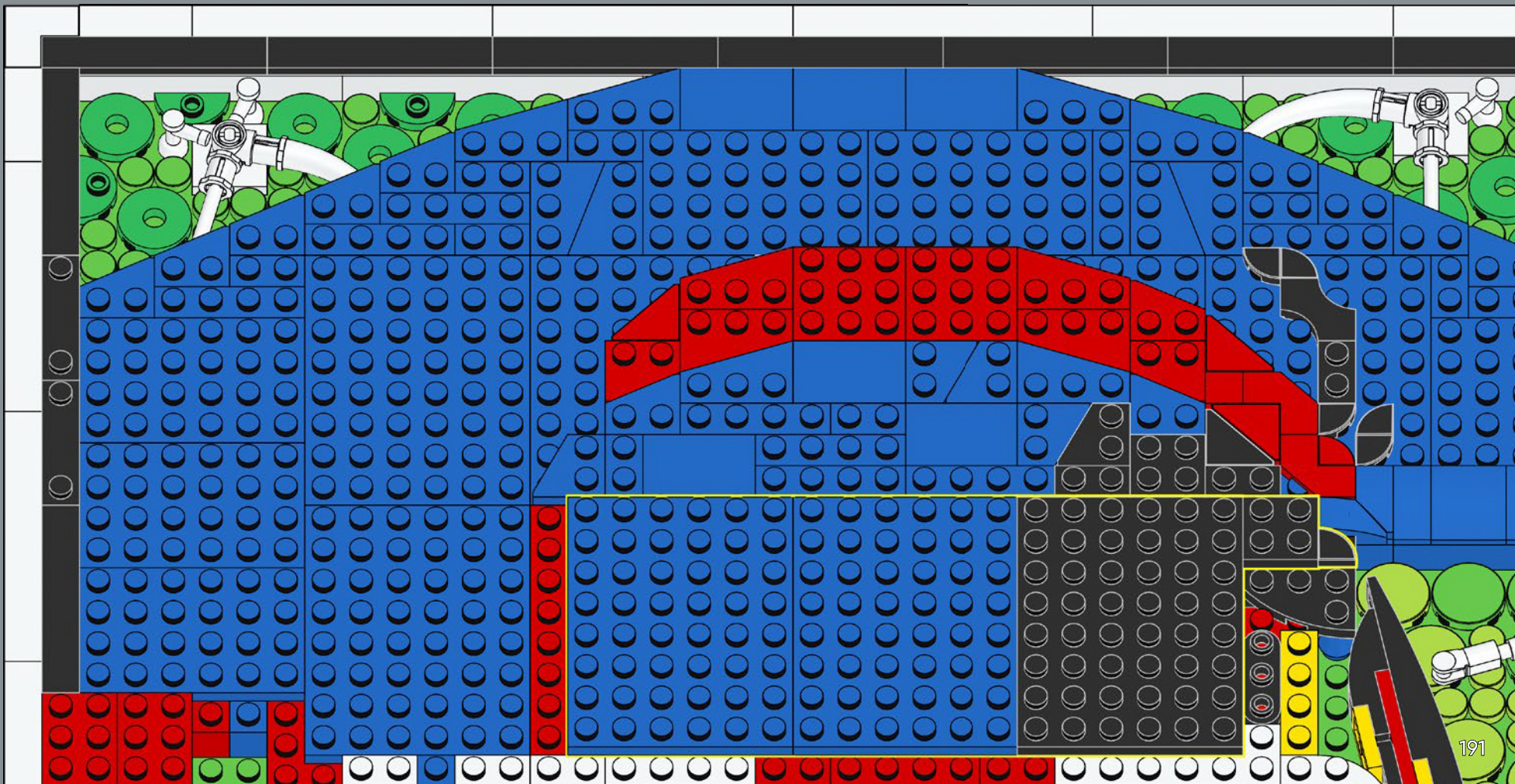

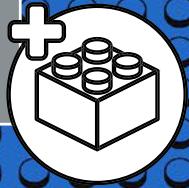
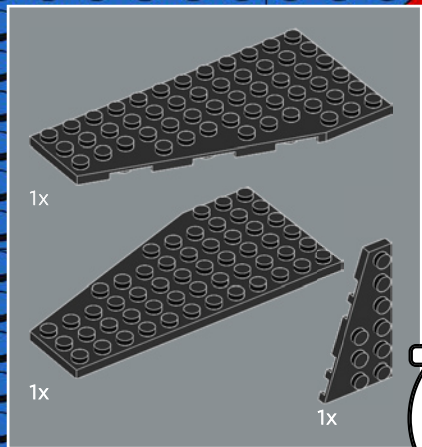

222

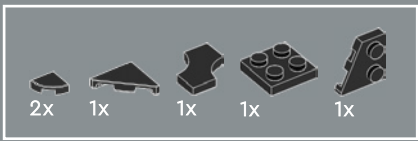

224

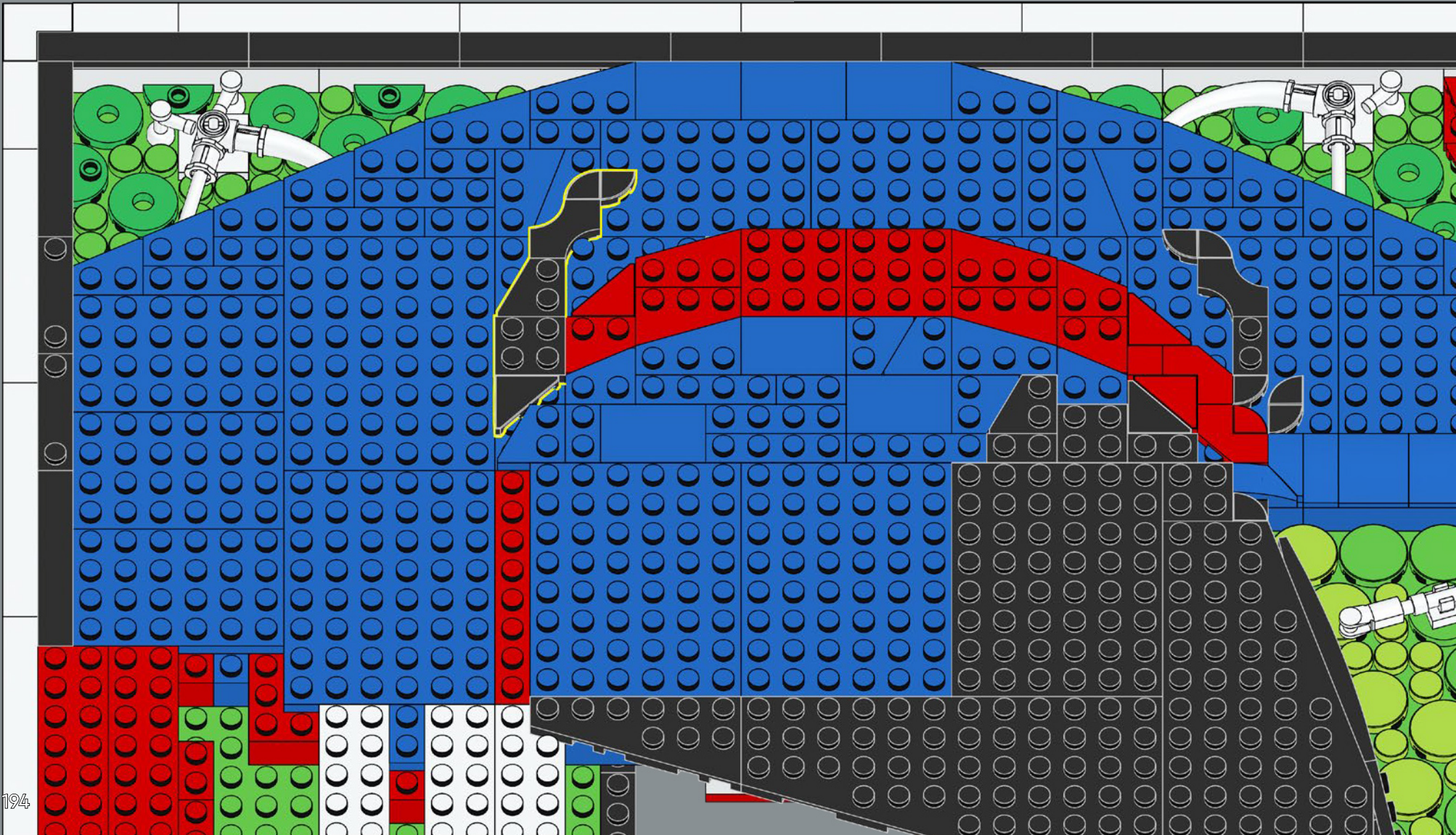

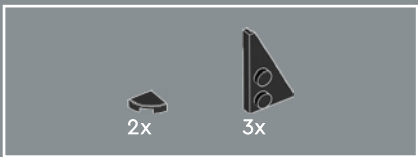

225

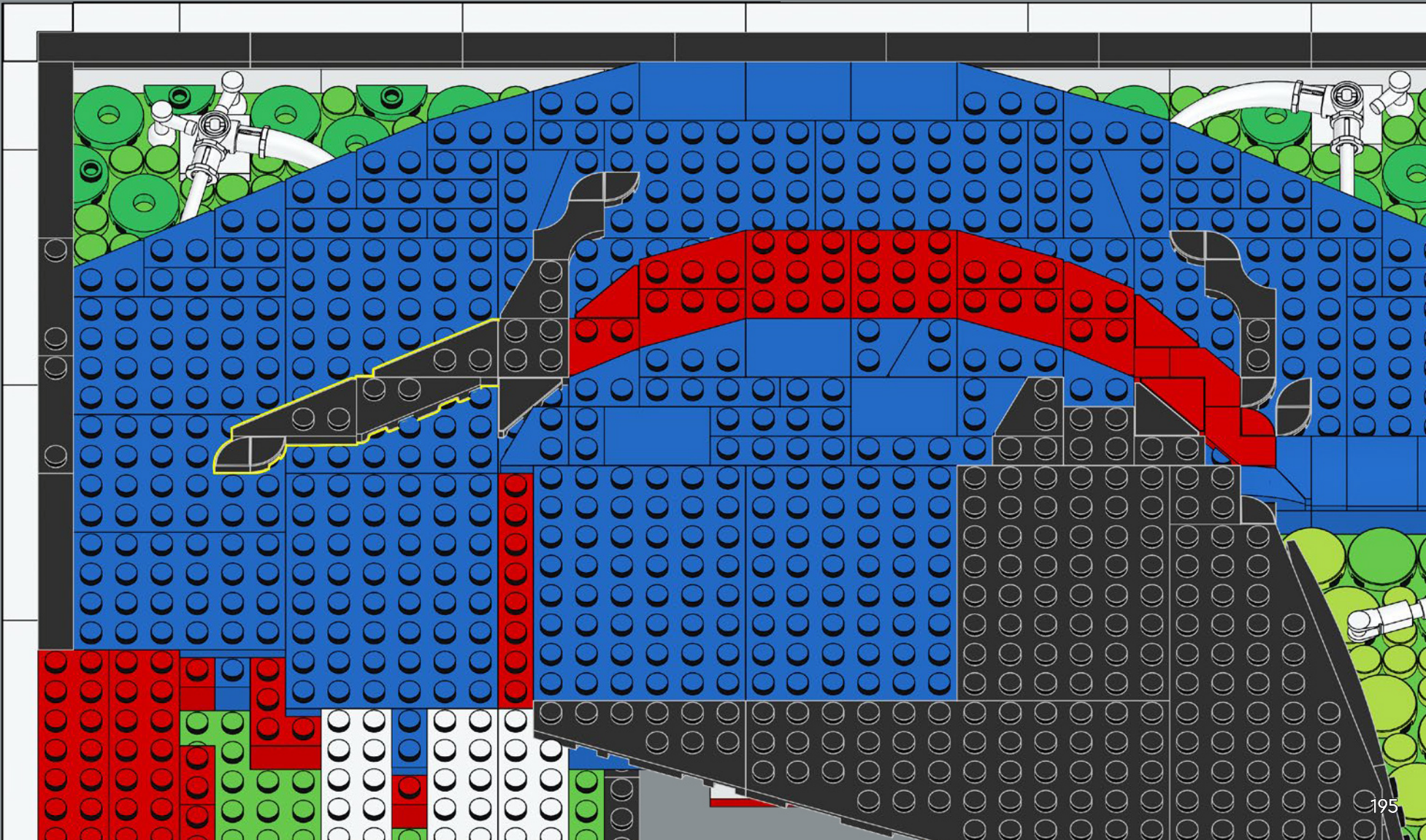

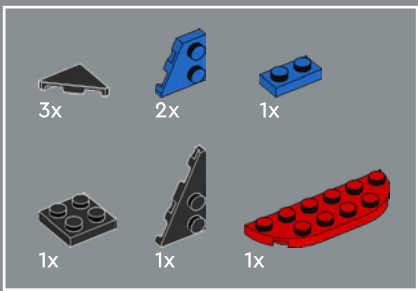

226

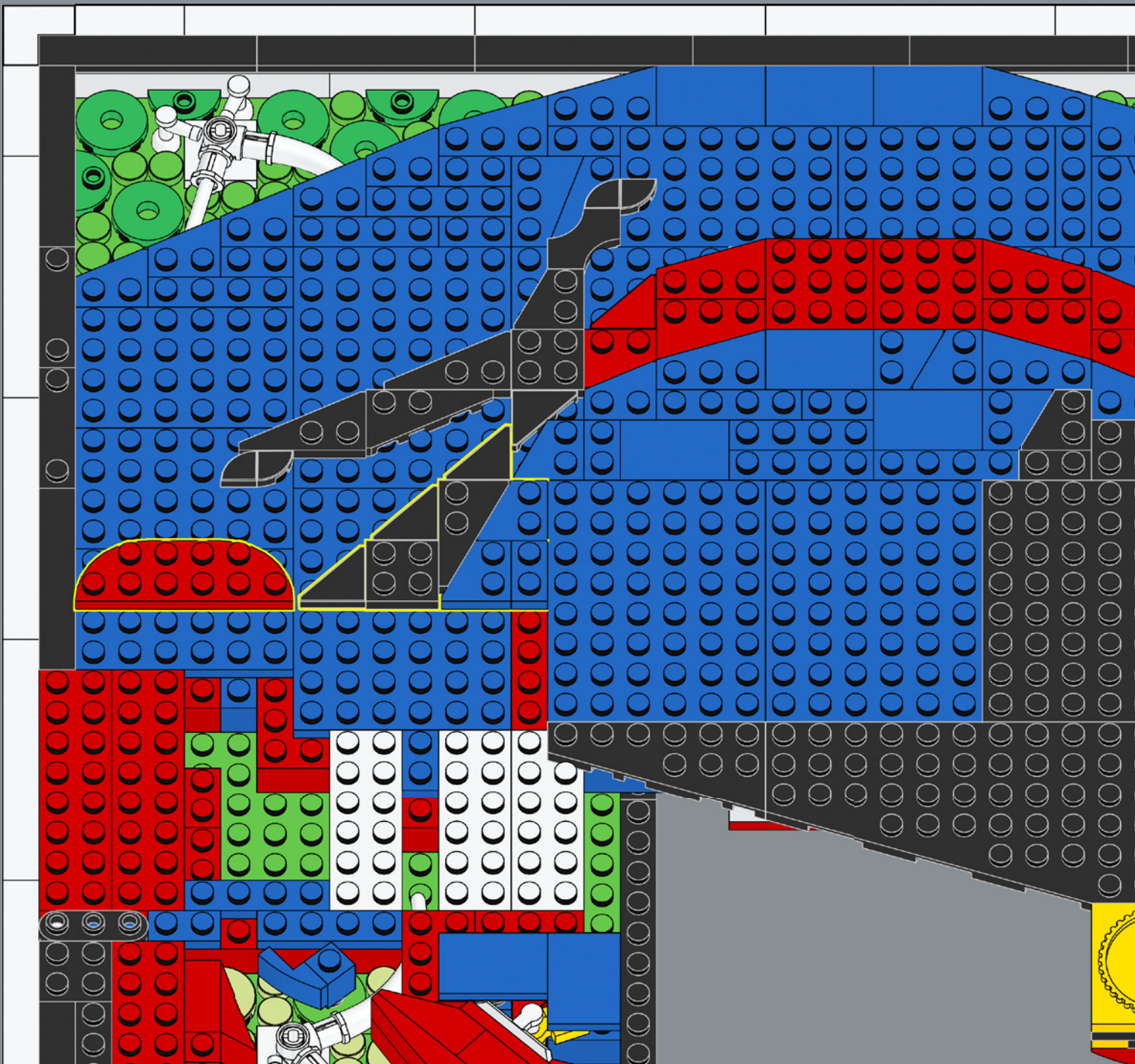

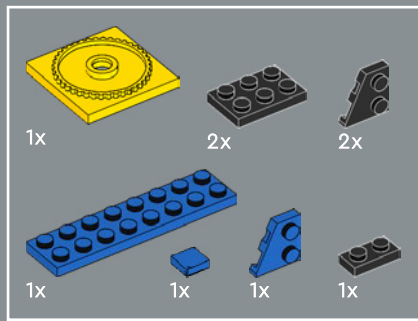

227

The placement of these yellow turntables is important! Precisely **18 across** and **3 up** ...

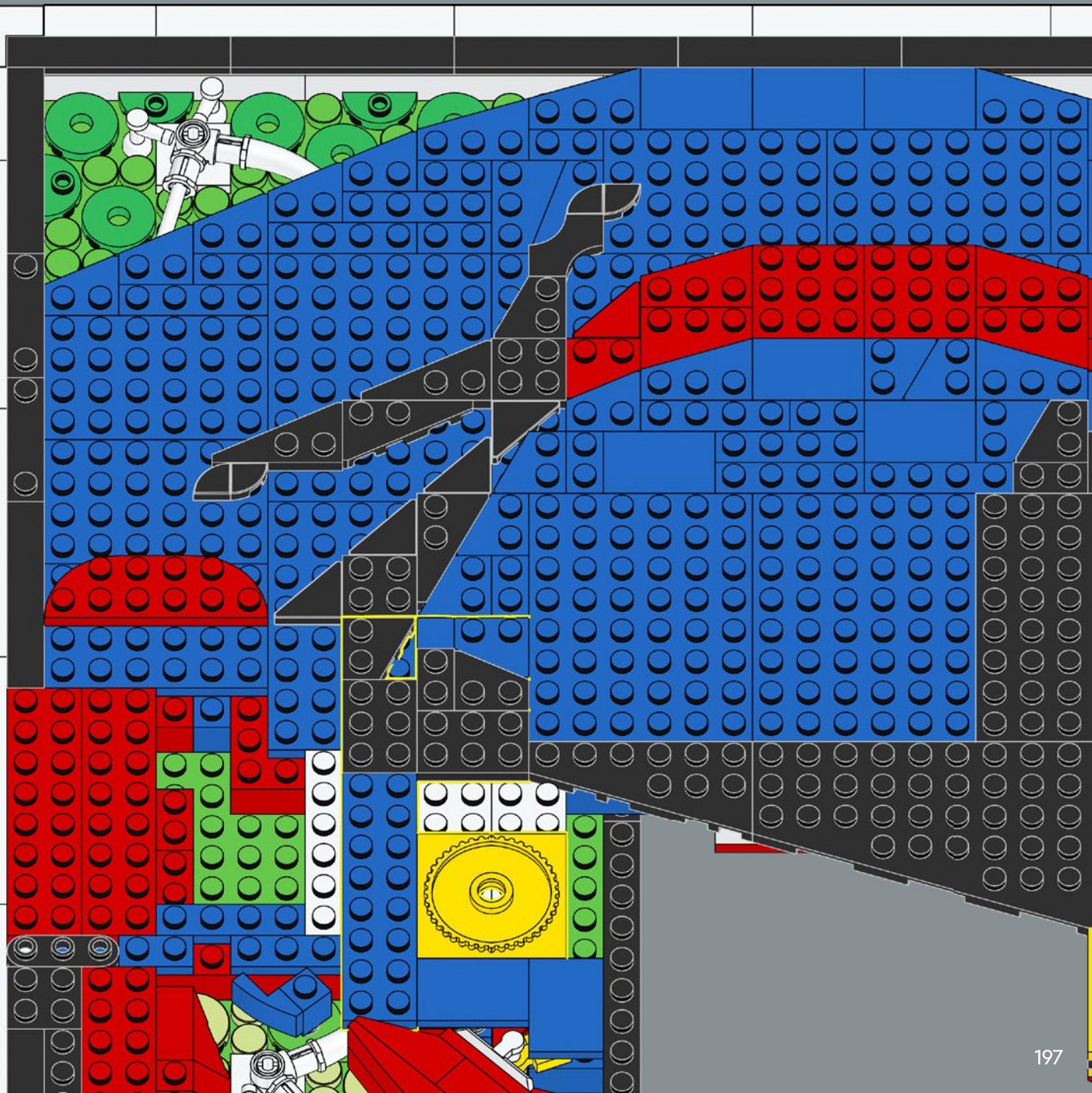

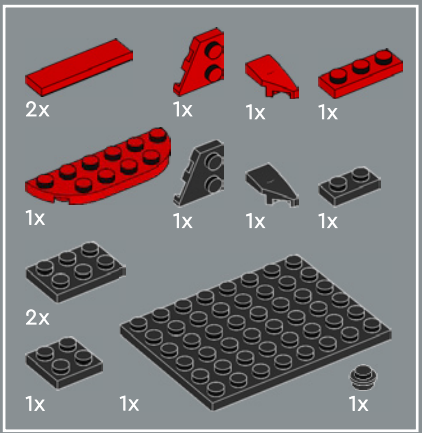

228

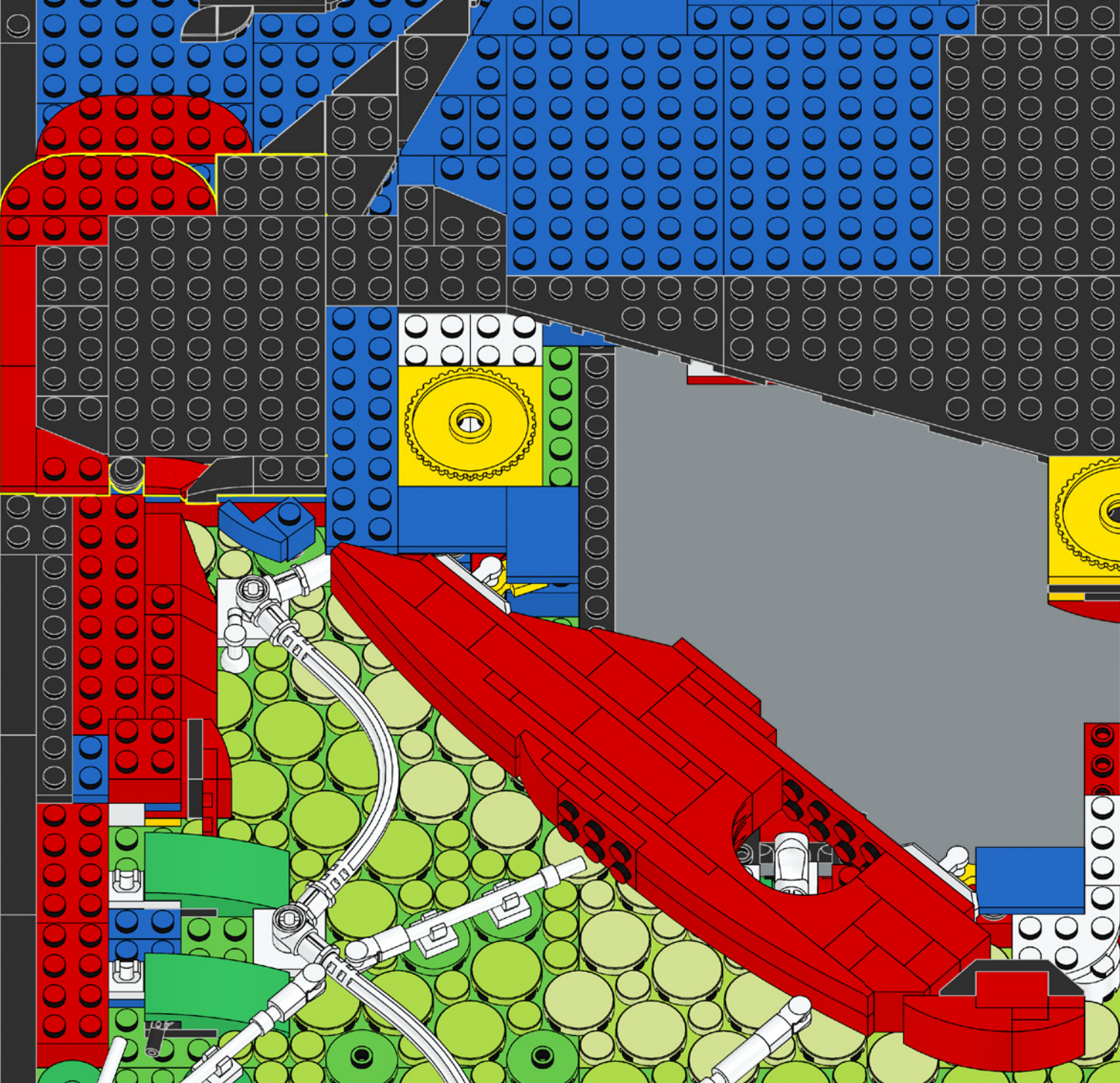

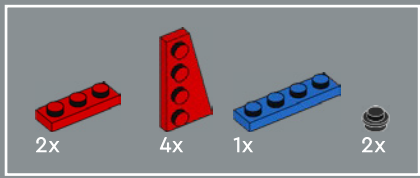

229

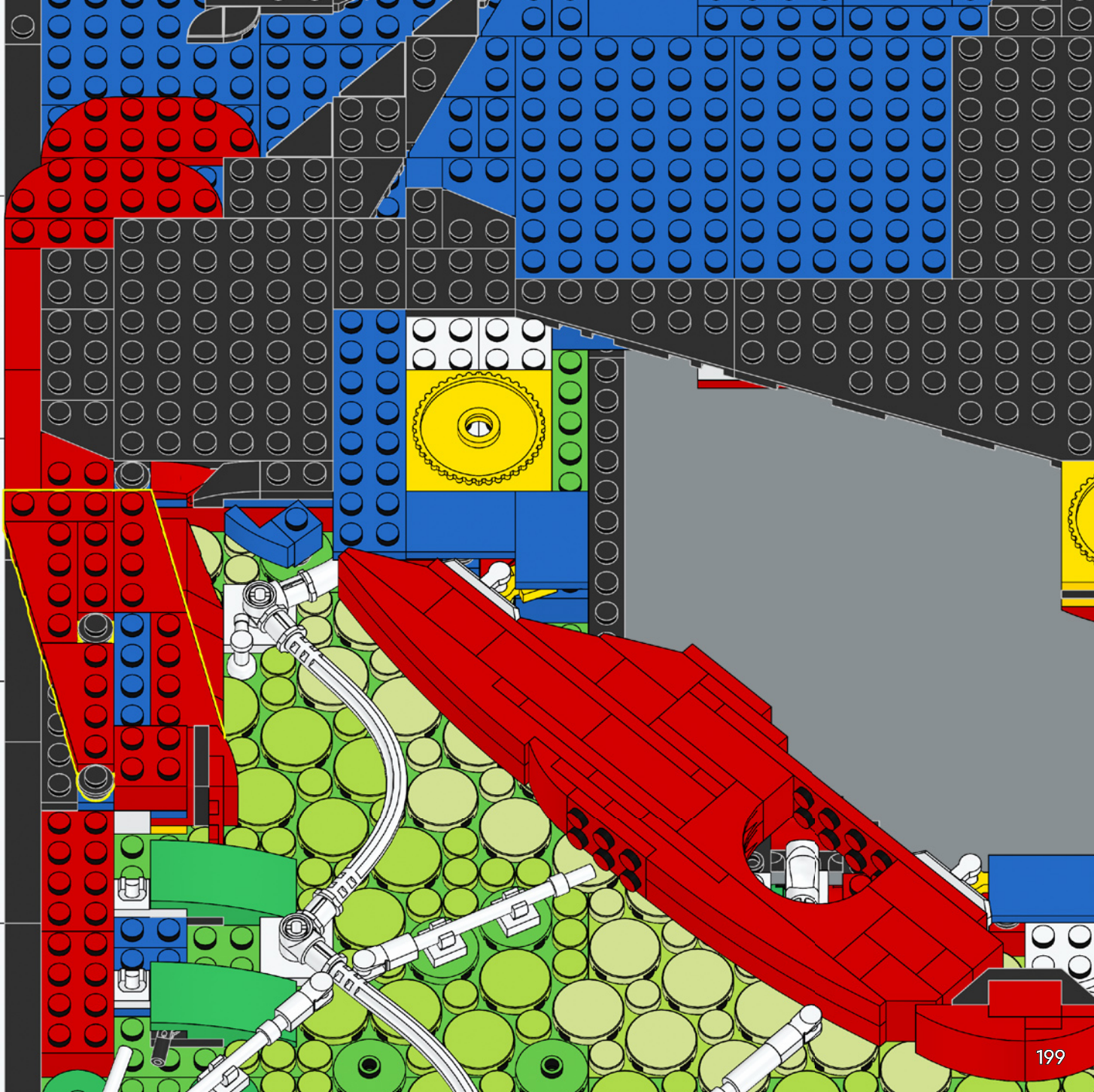



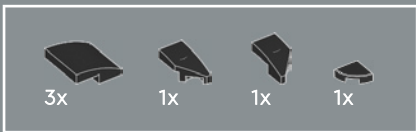

230

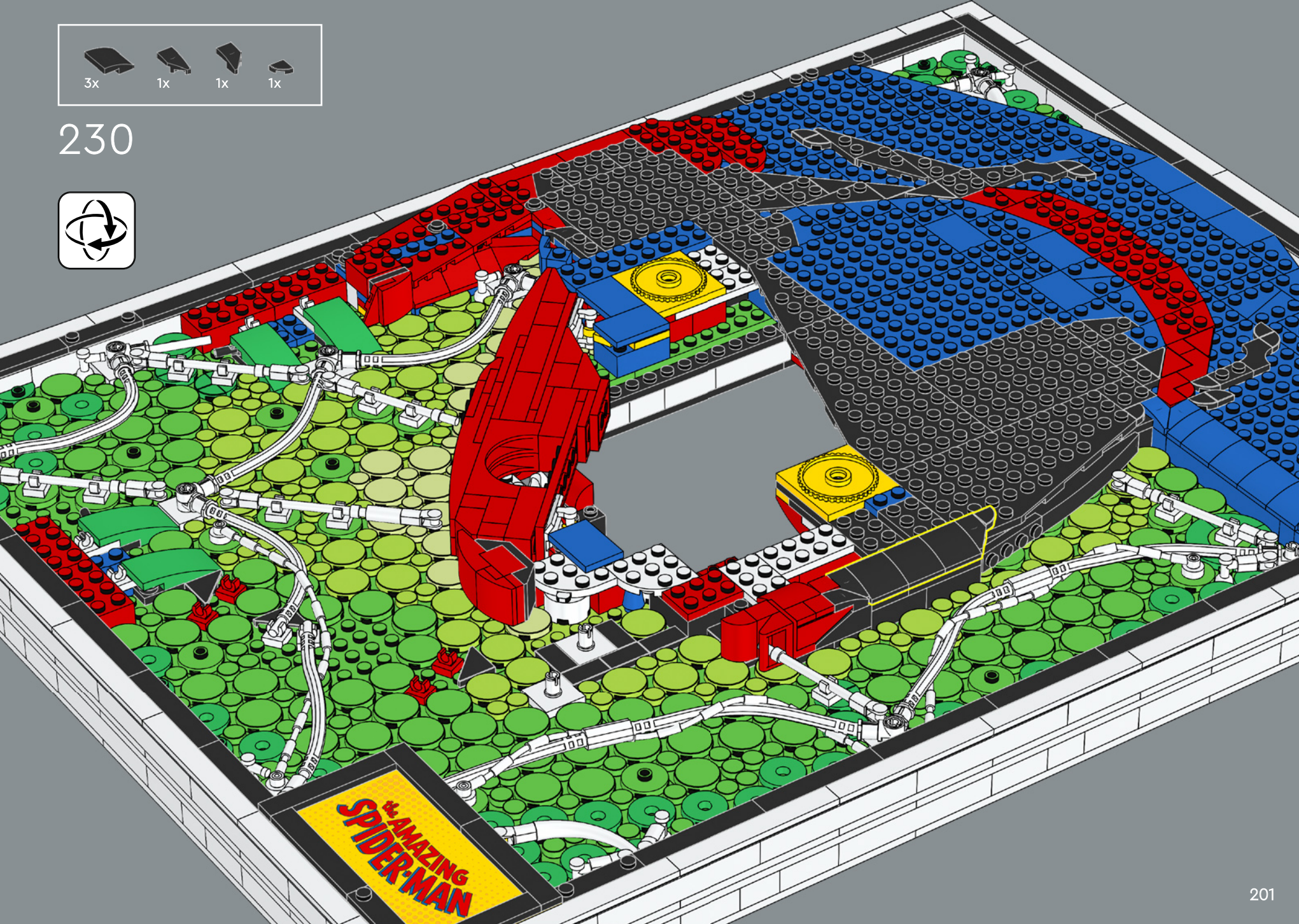



231

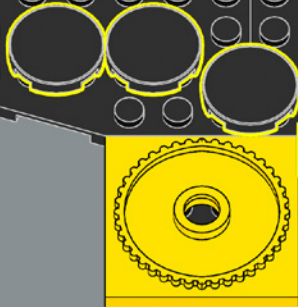
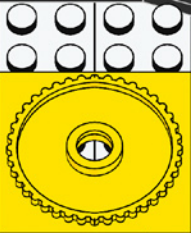

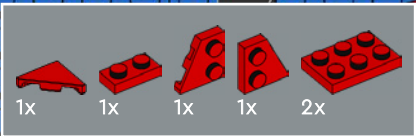

232

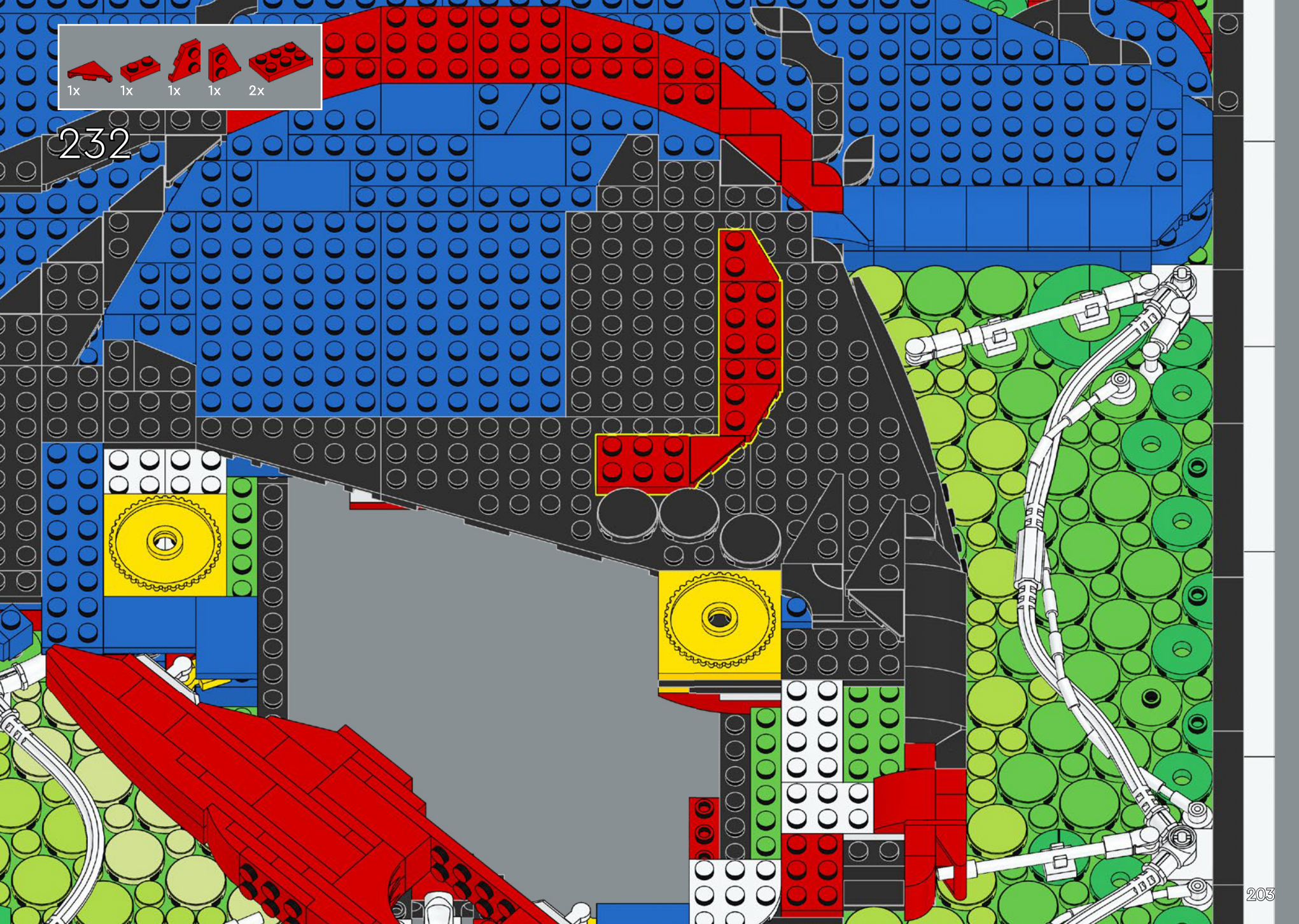

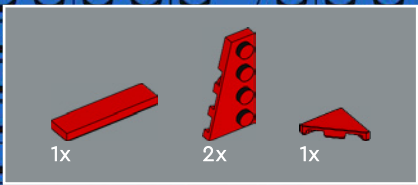

233

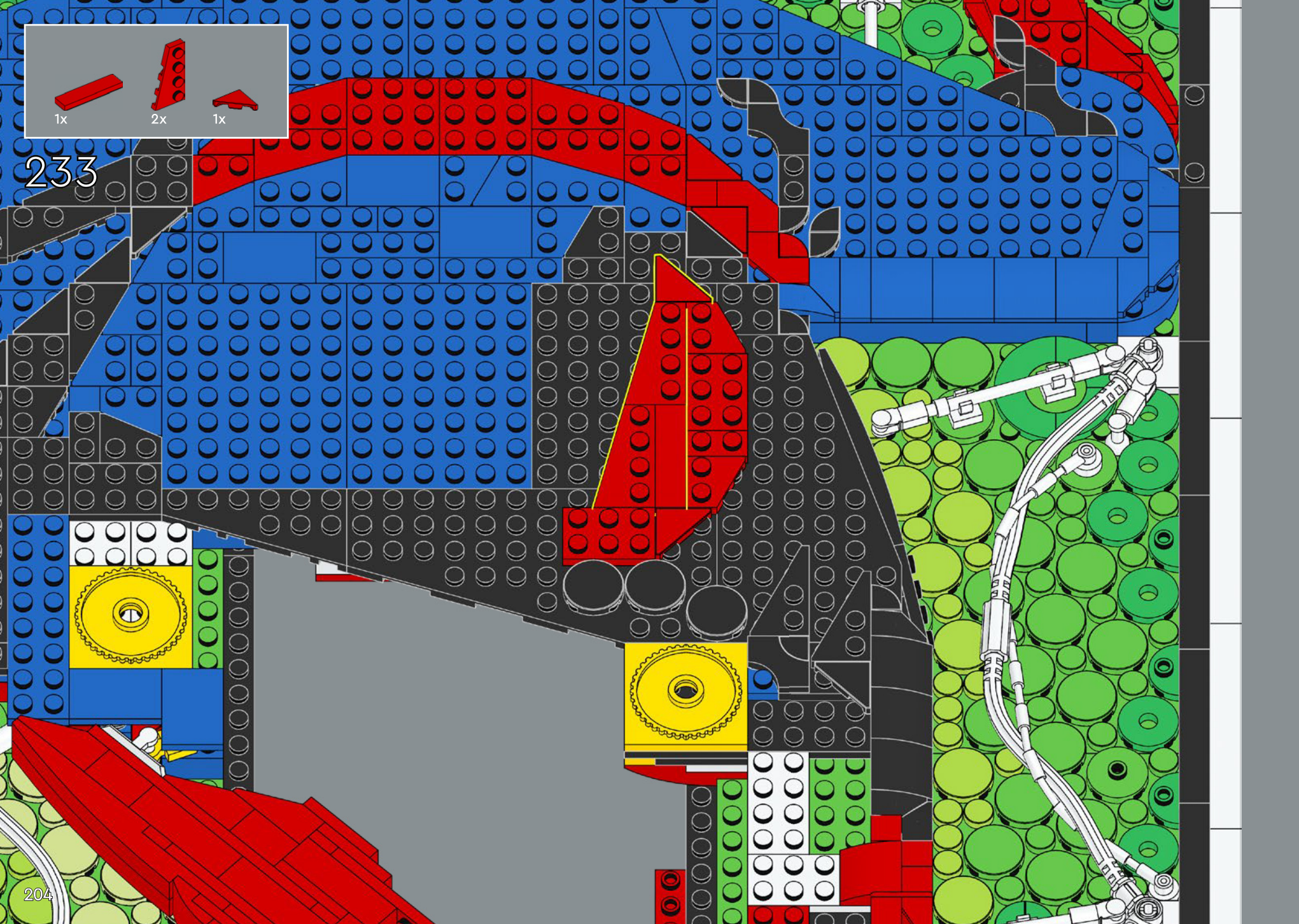

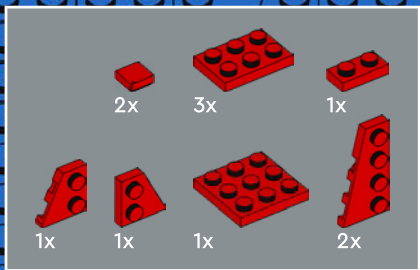

234

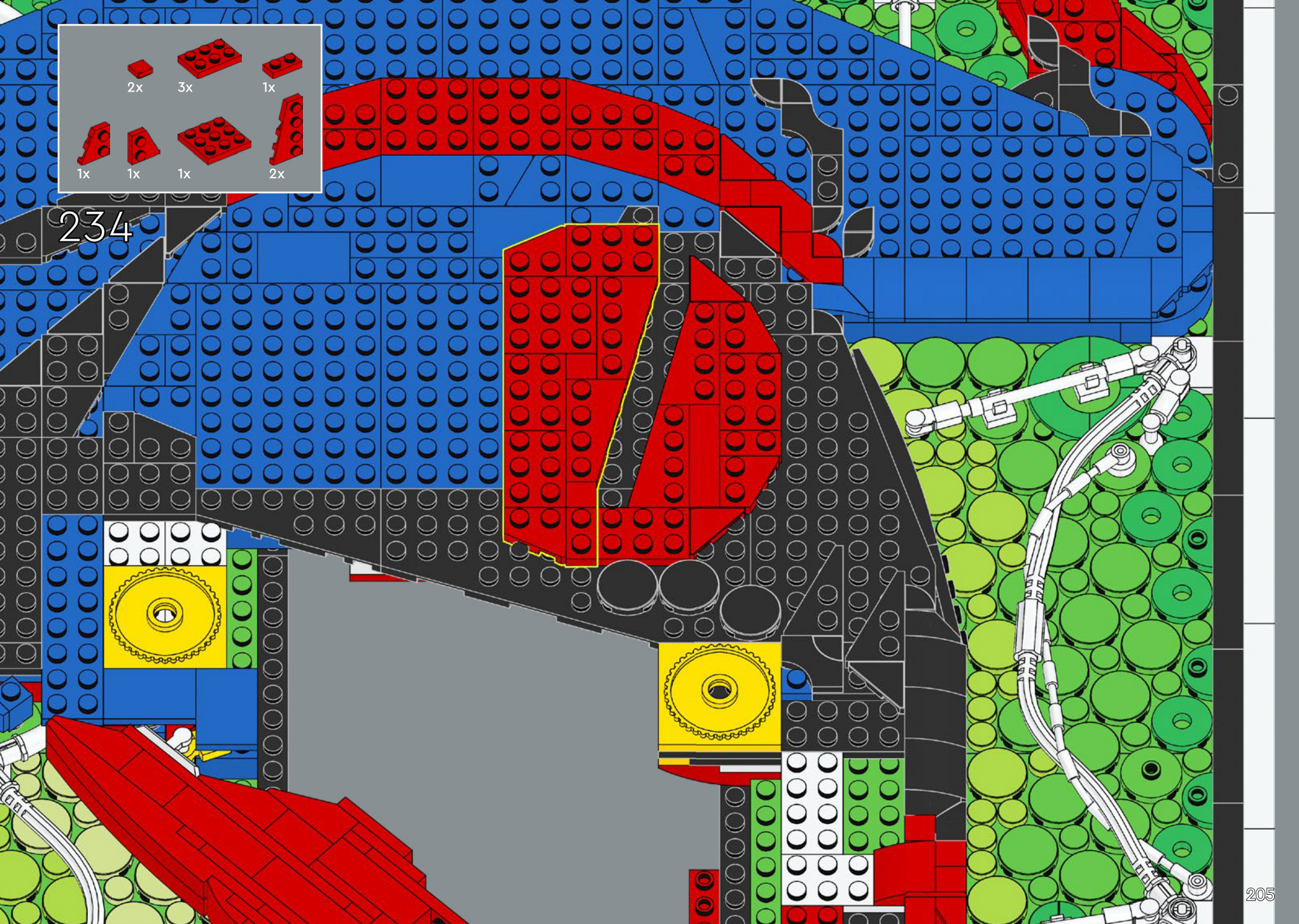



235

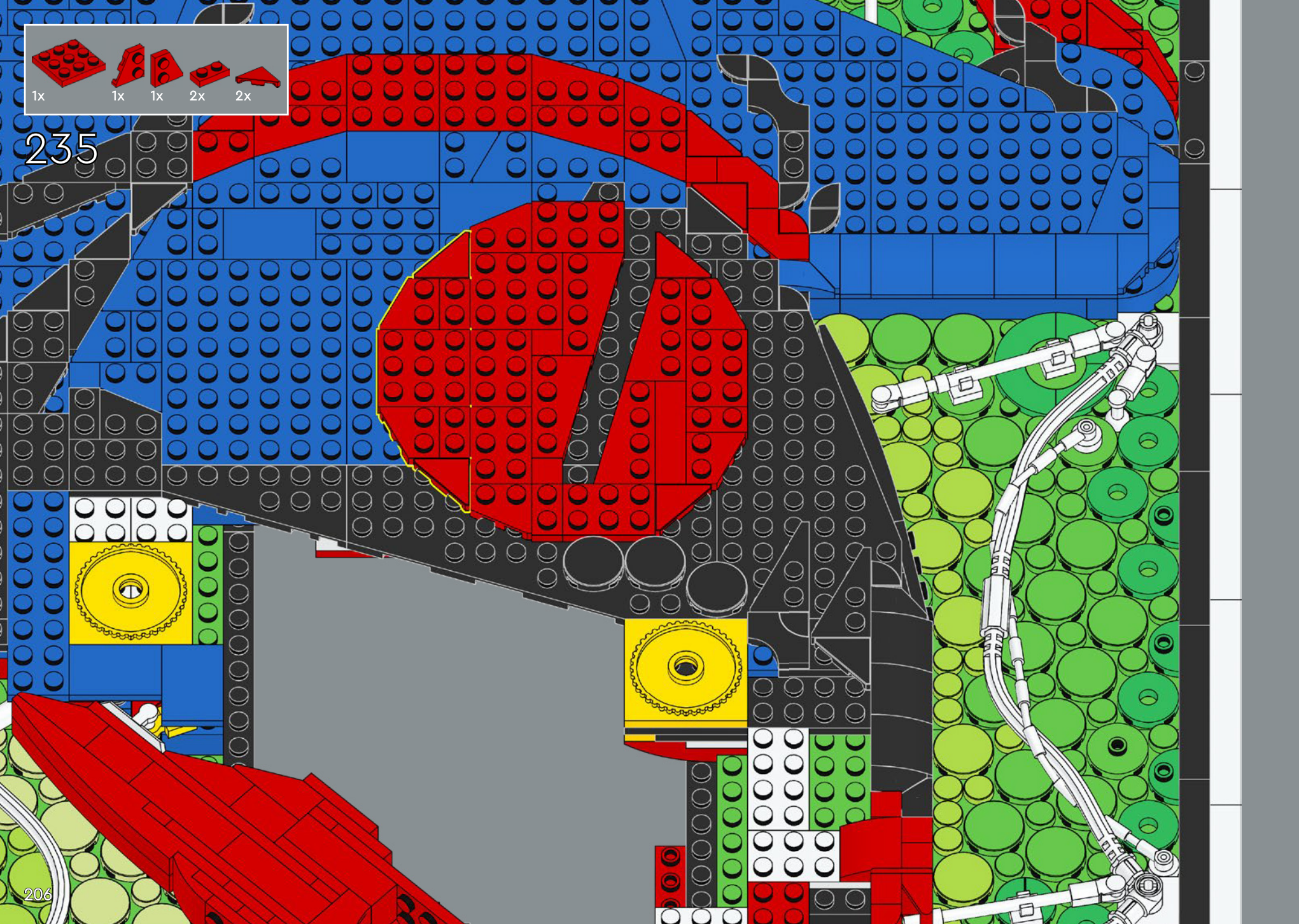

1x  3x 

236

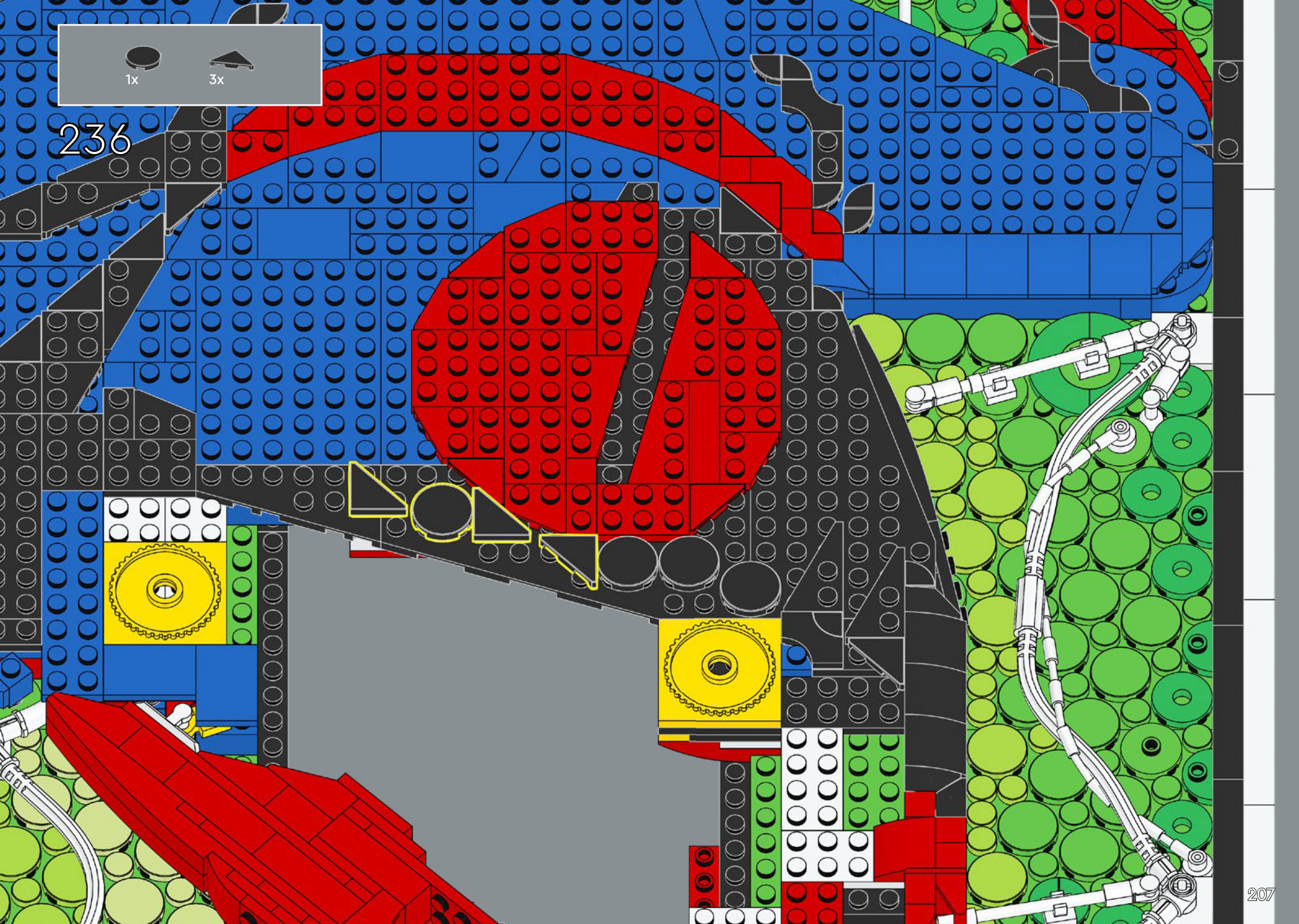

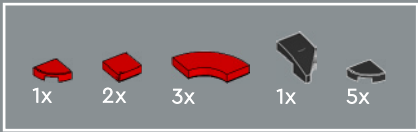

237

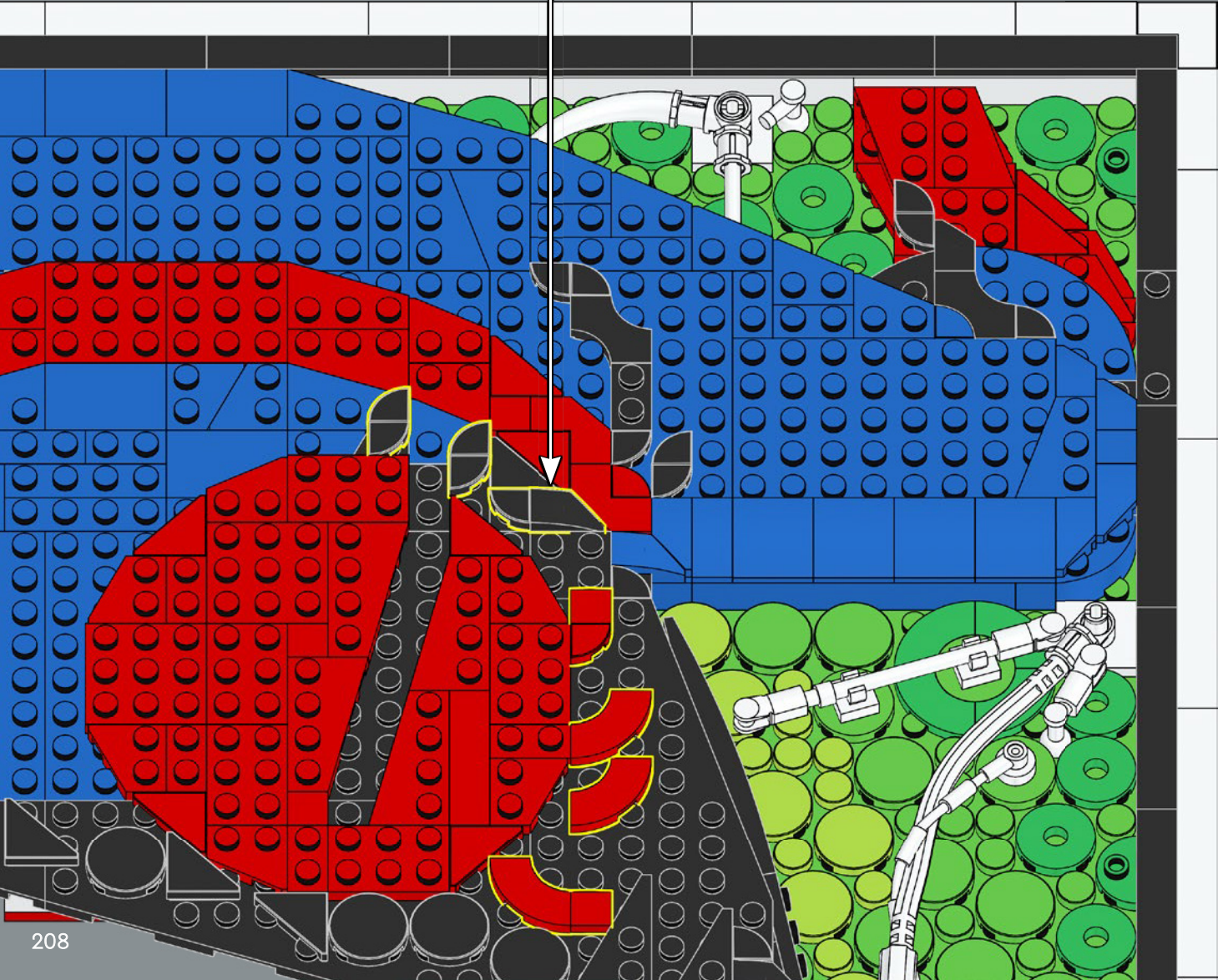

8x 4x

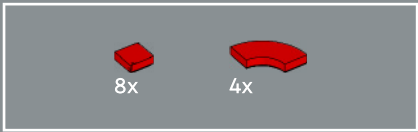

238

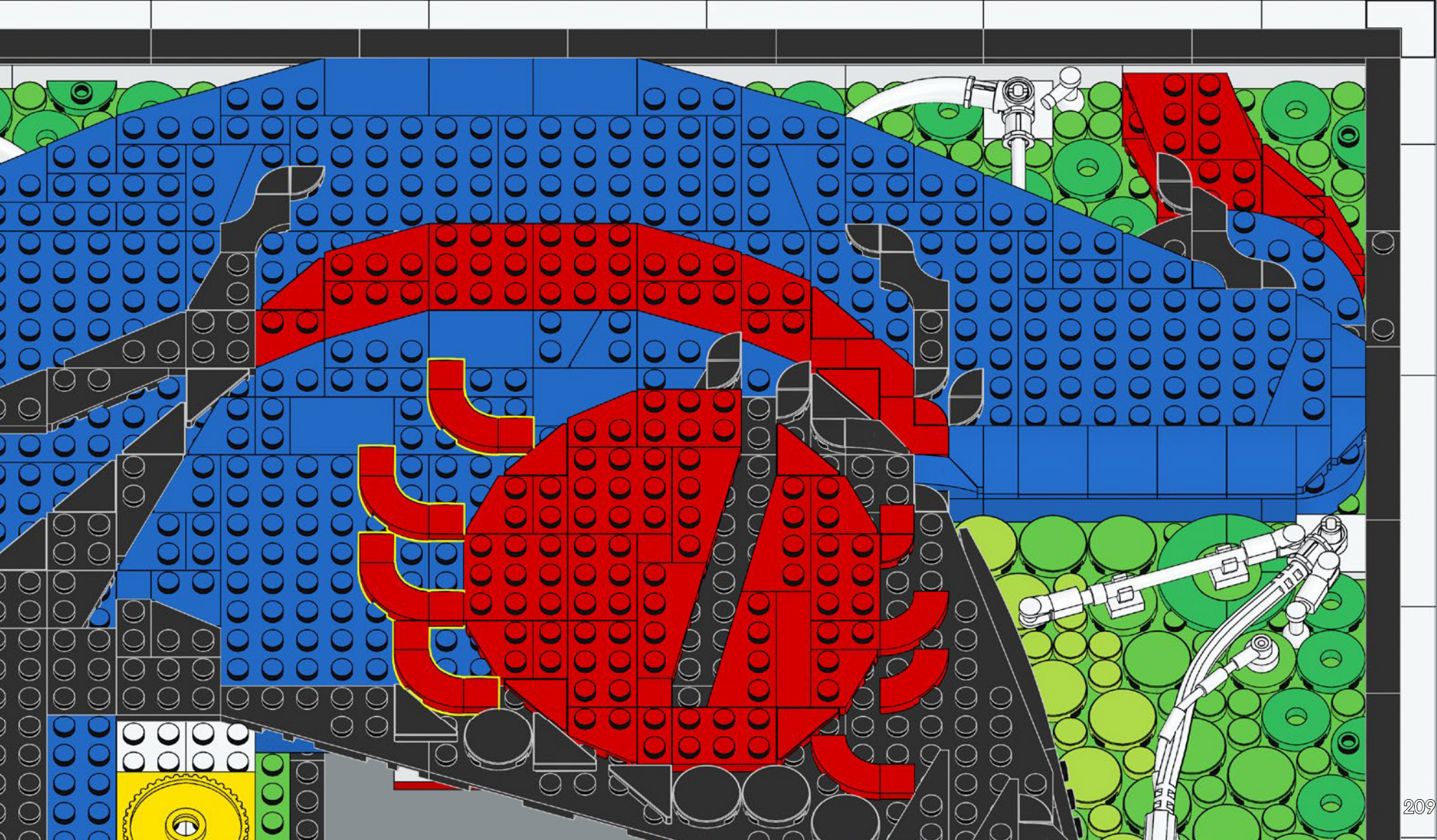

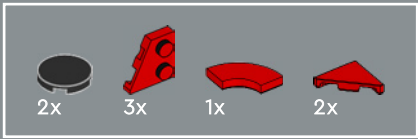

239

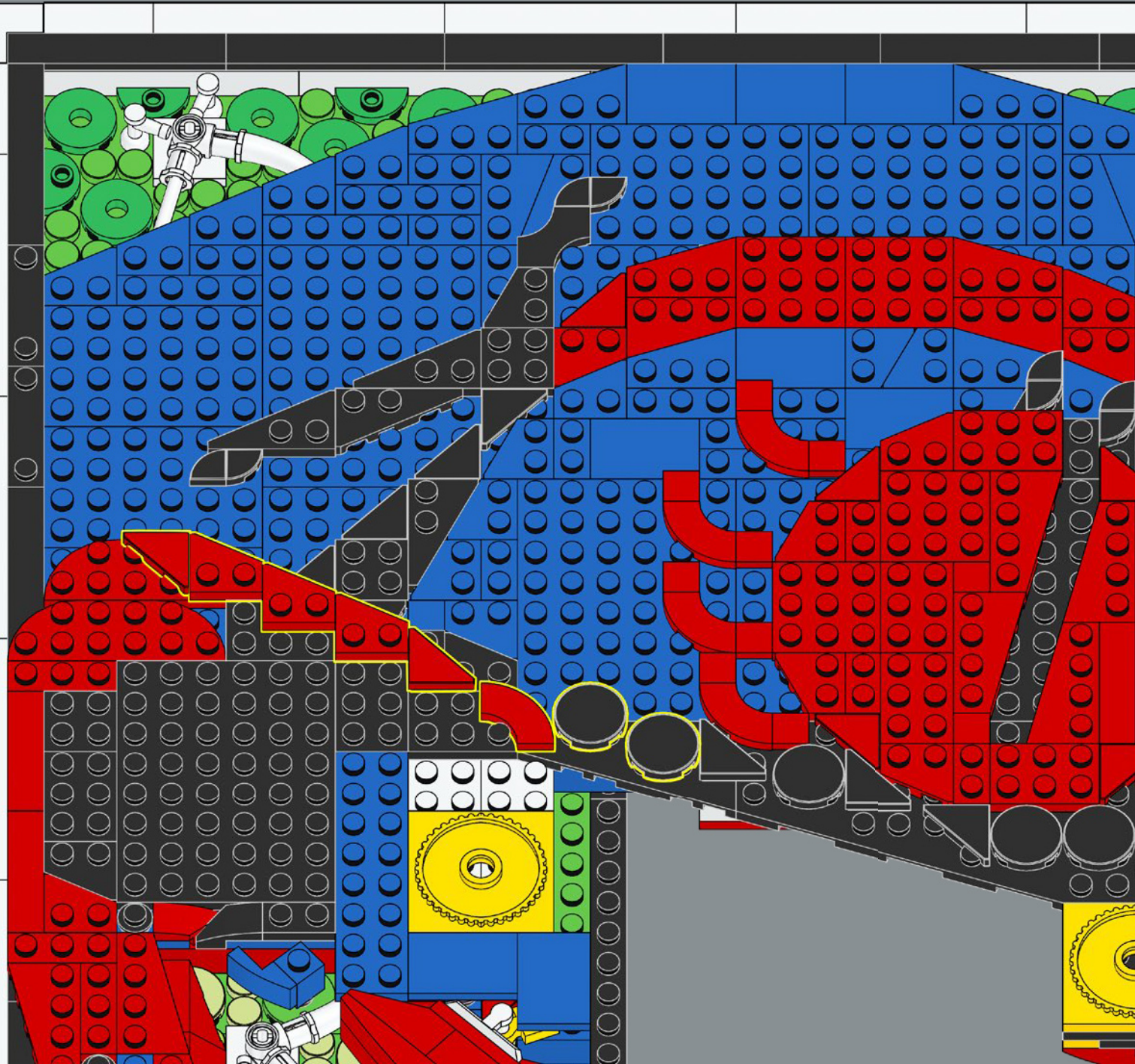

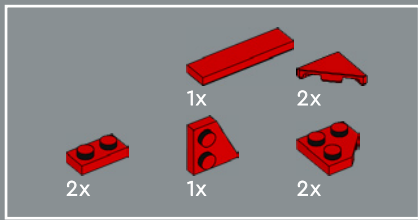

240

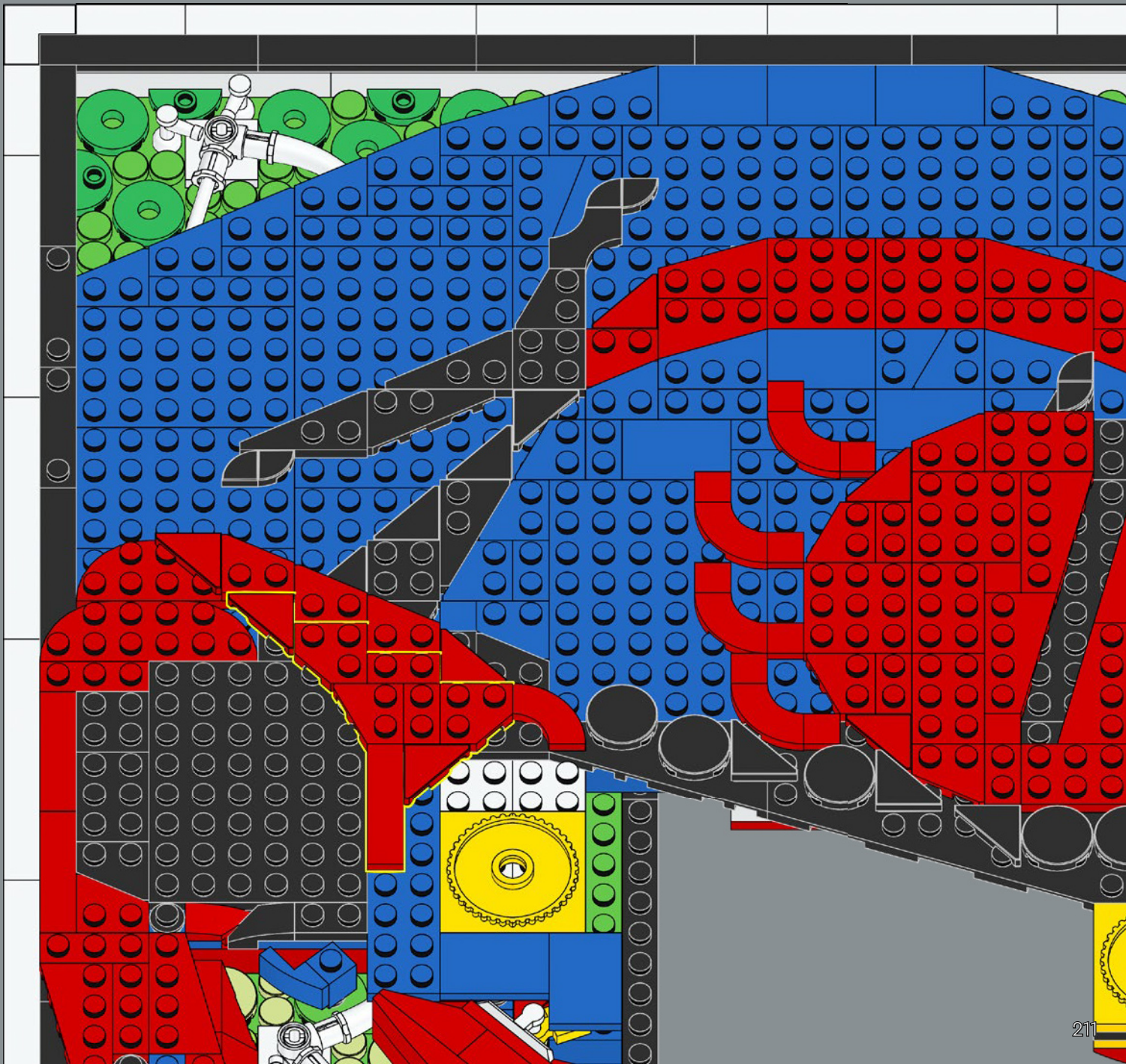



241

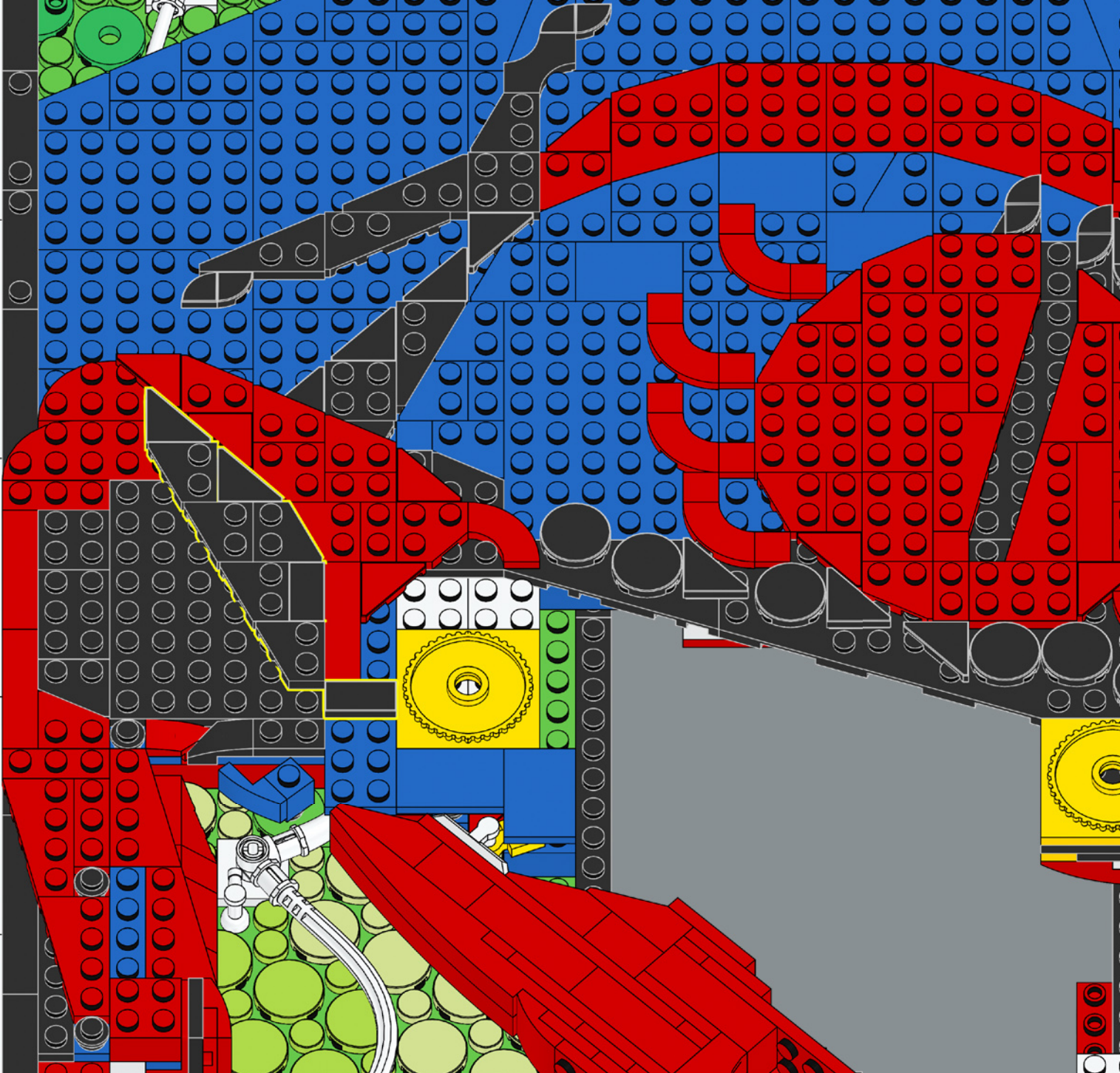

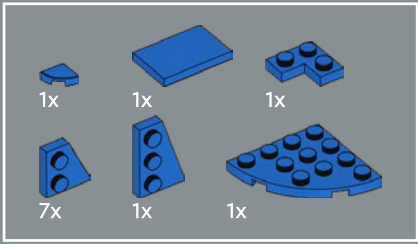

242

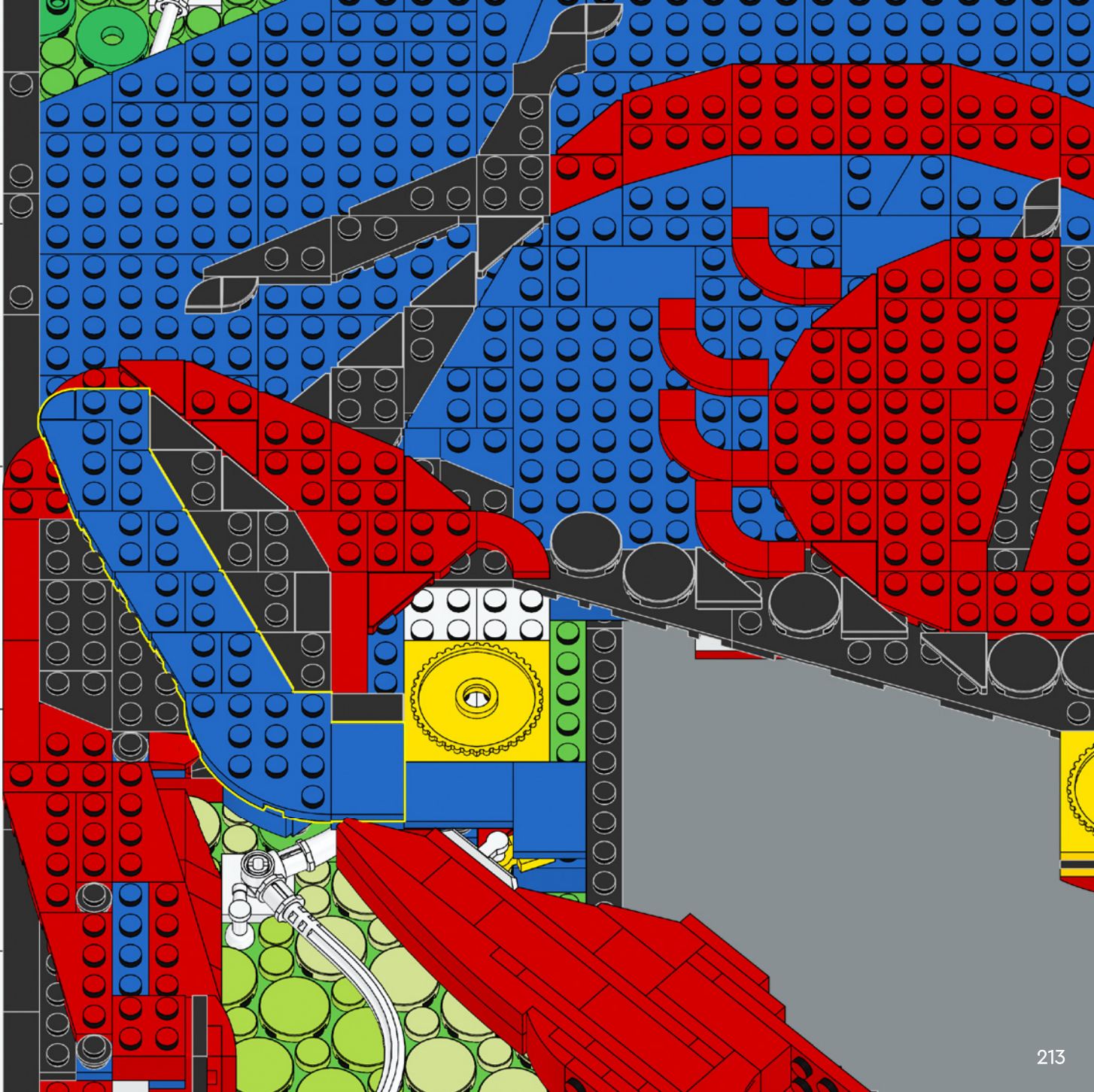

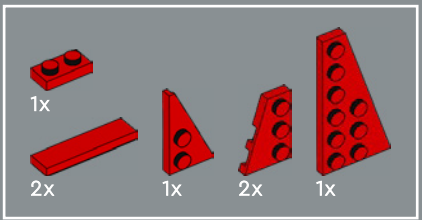

243

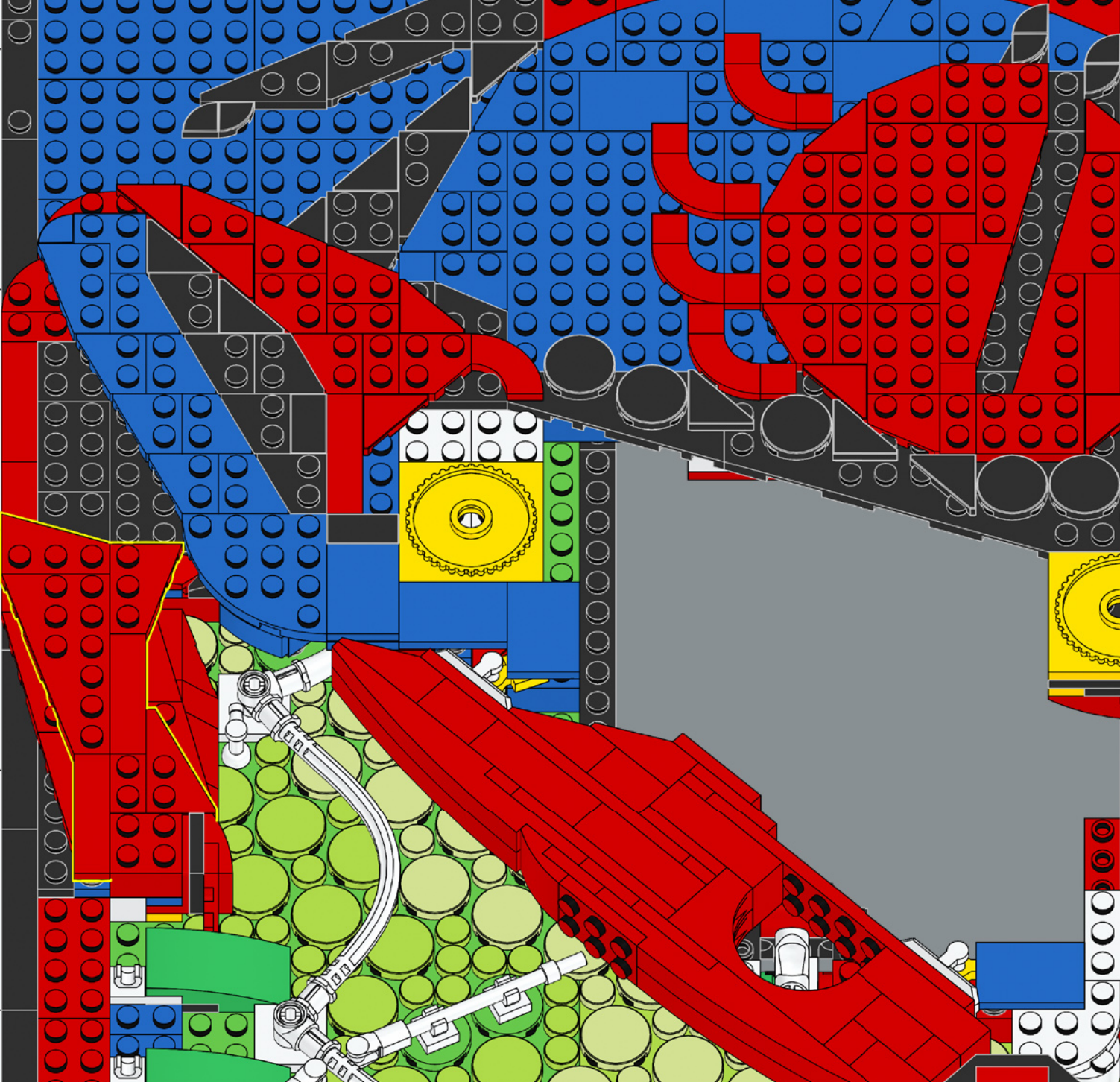

8x

244

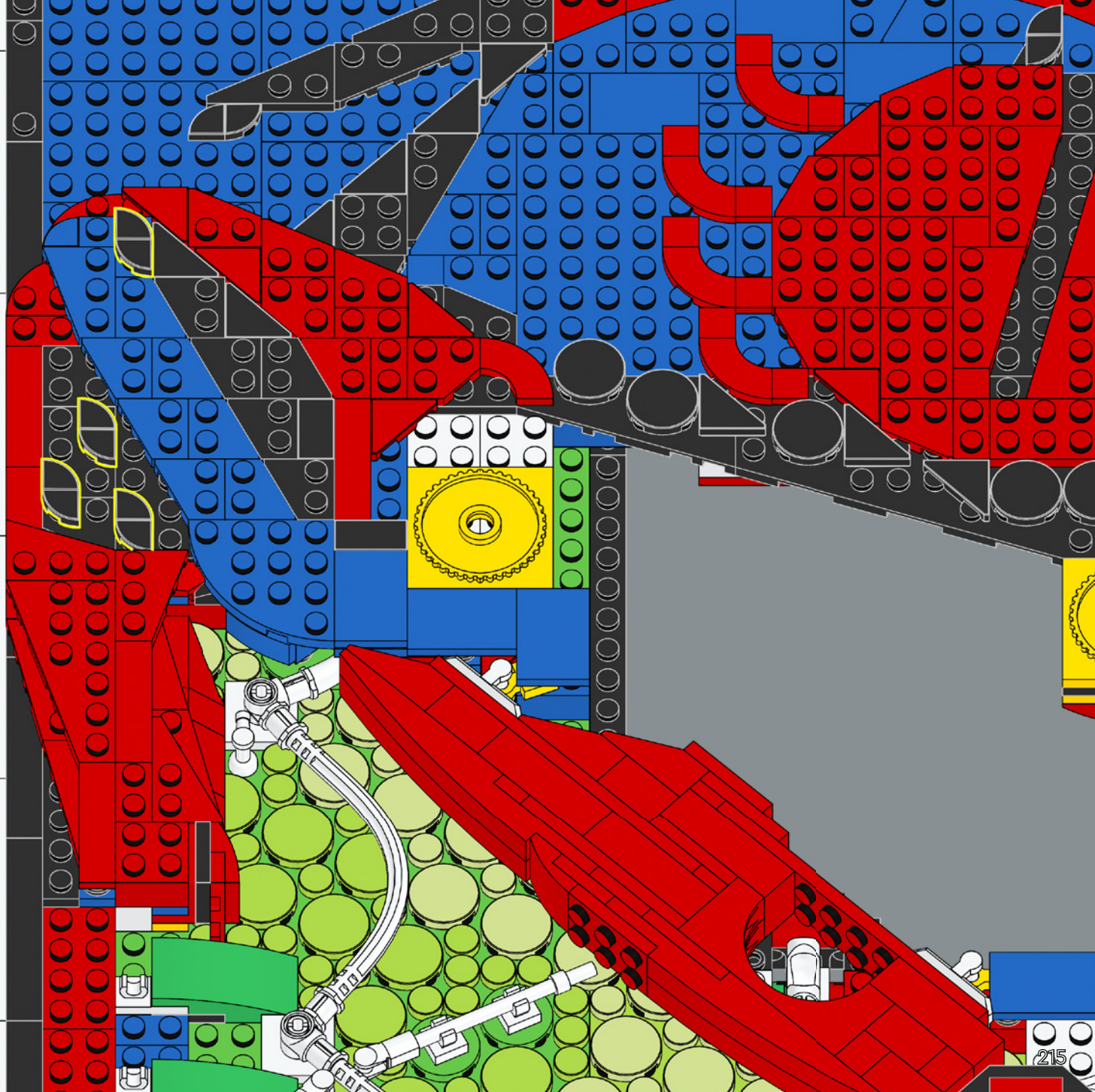

215

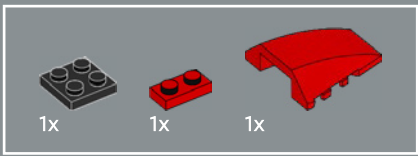

245

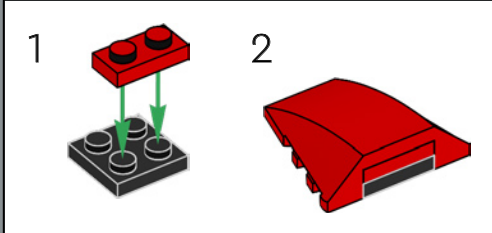

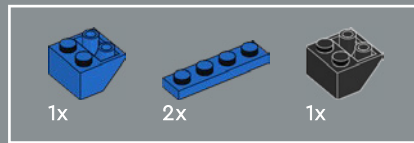

247

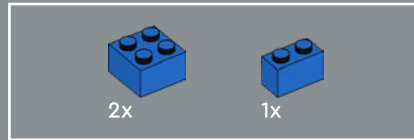
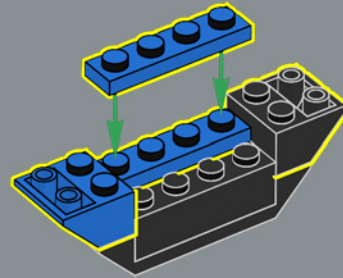

248

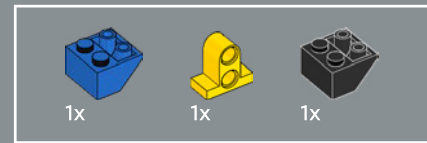
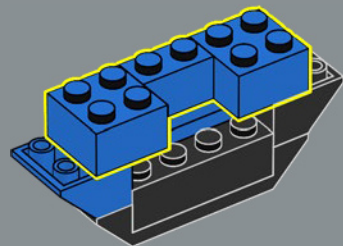

249

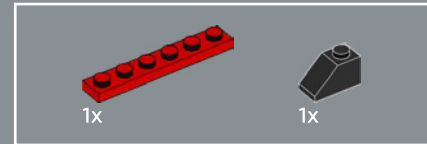
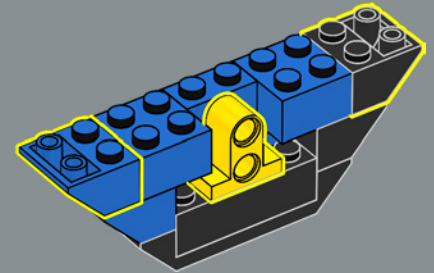

250

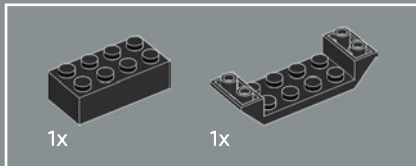
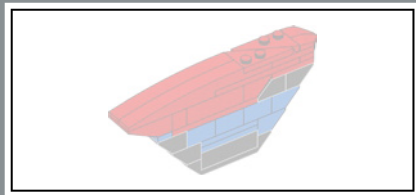
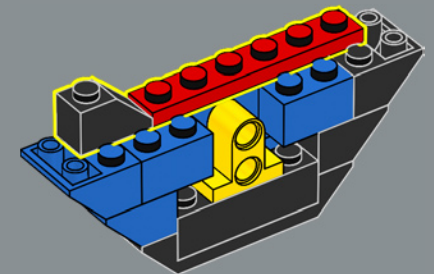

246

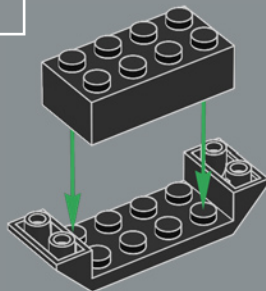

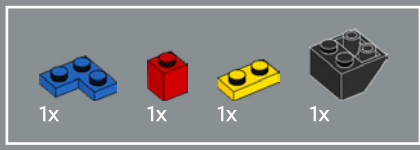

251

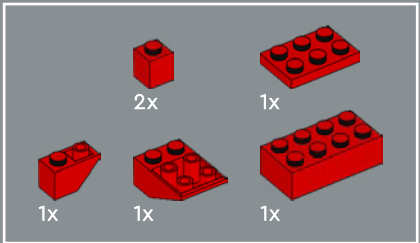
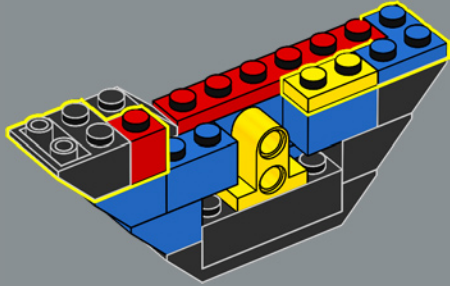

252

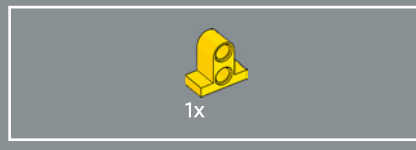
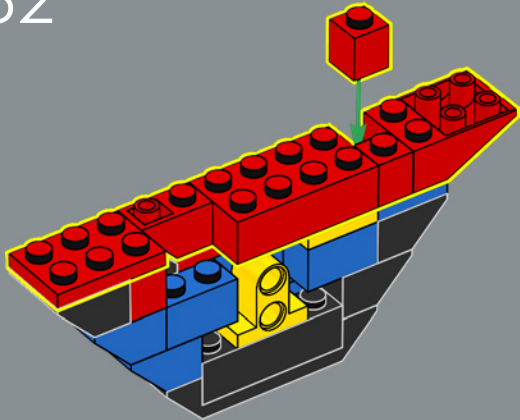

253

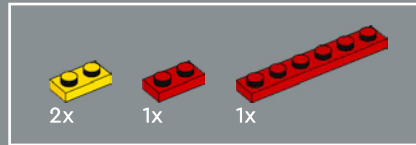
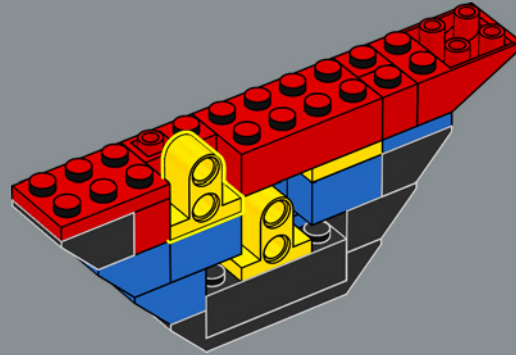

254

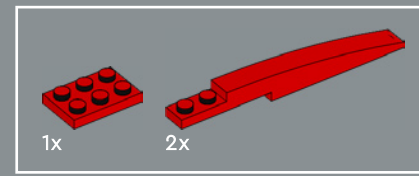
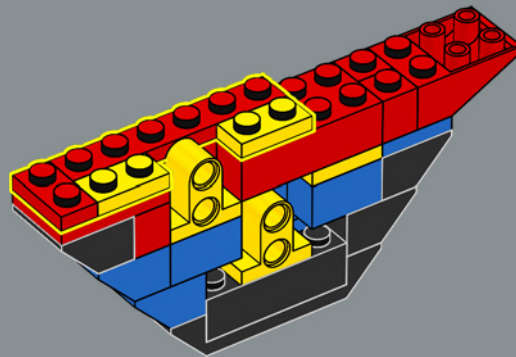

255

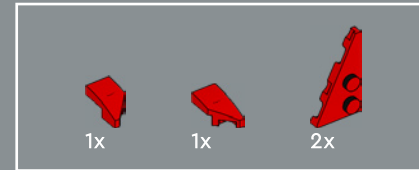
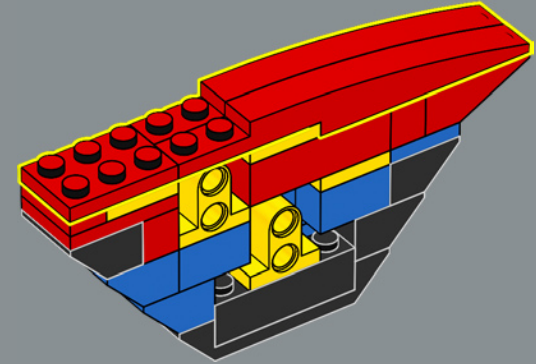

256

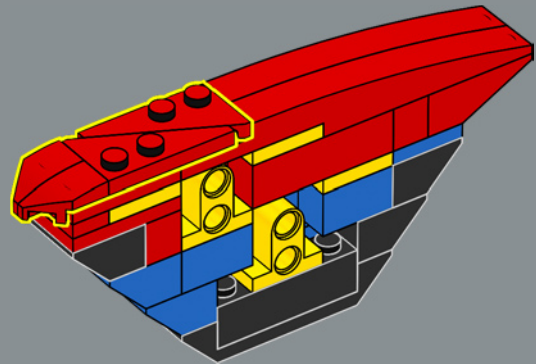

257

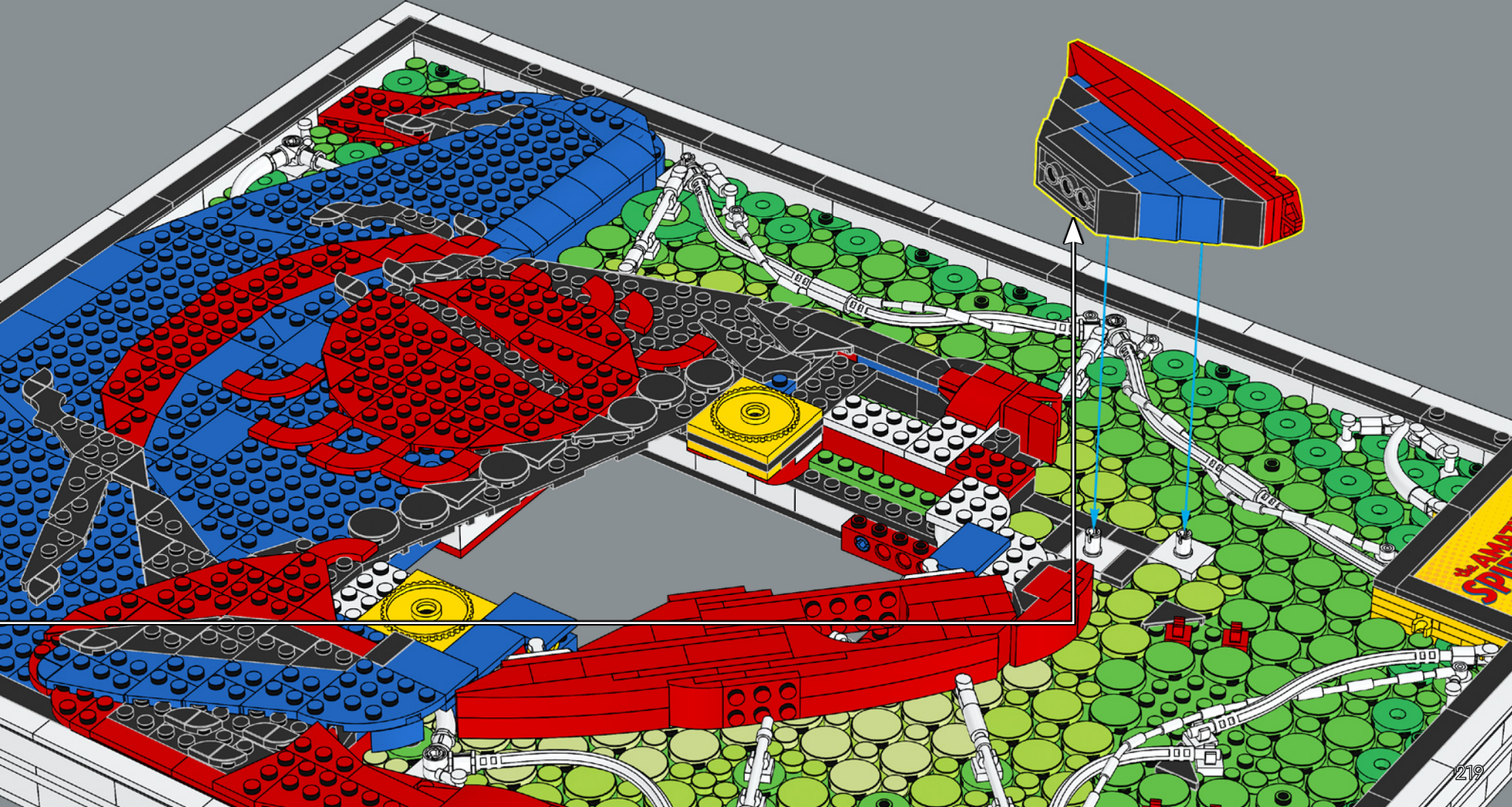
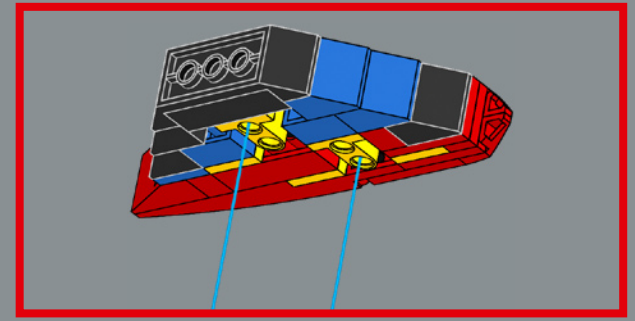



258

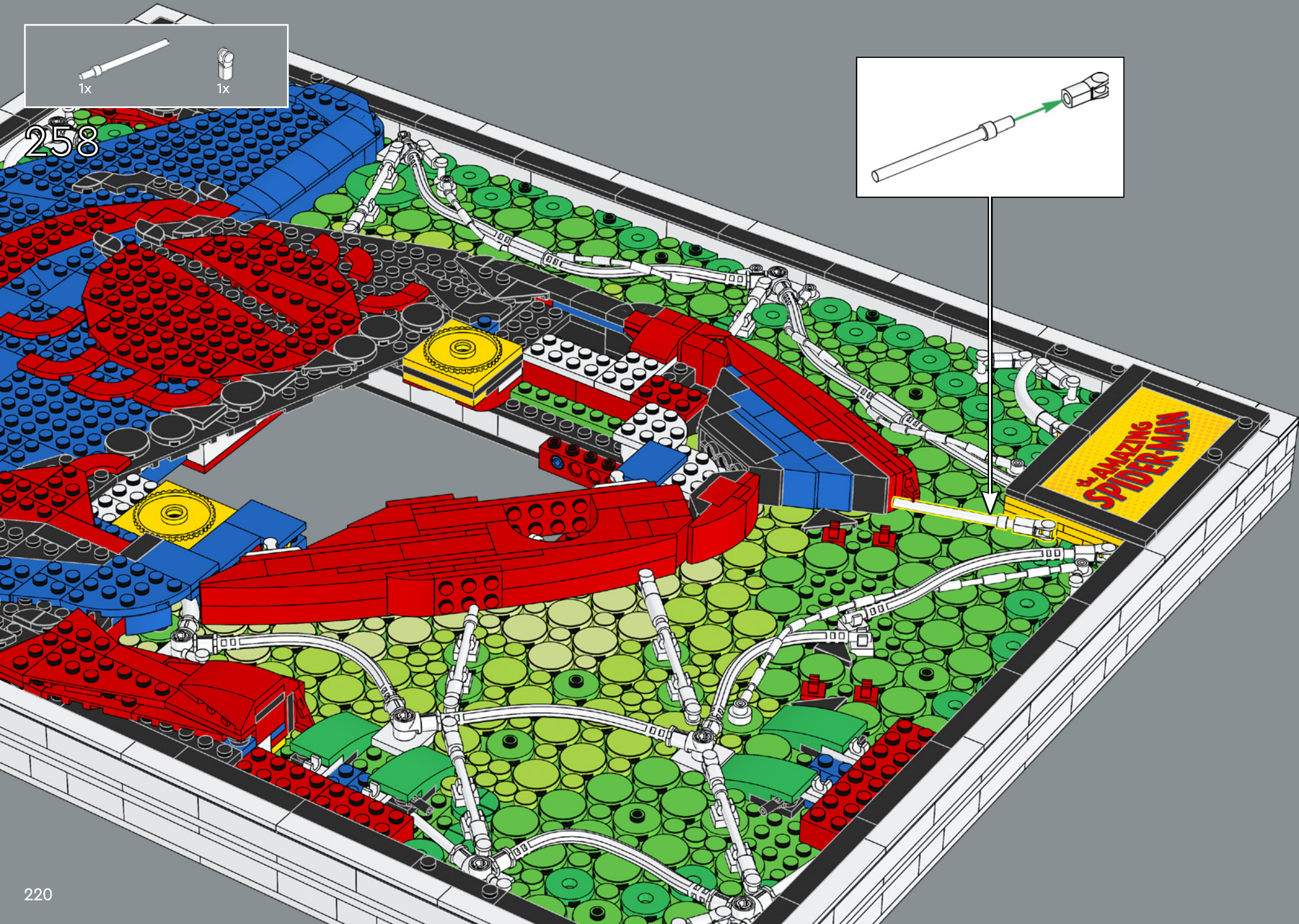
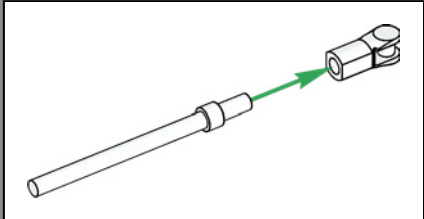

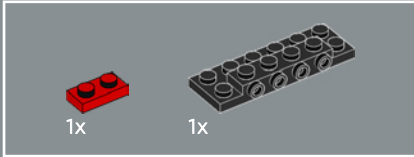
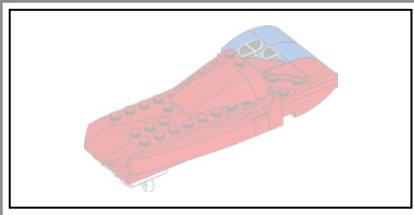

259

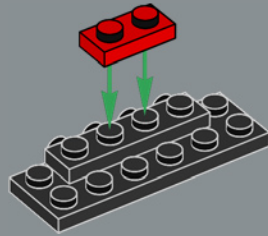

260

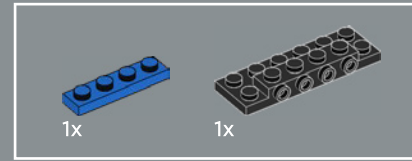
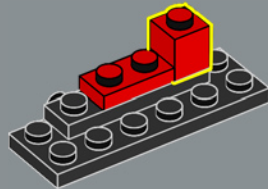

261

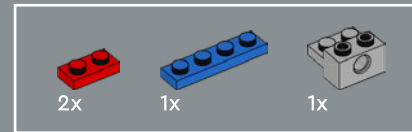
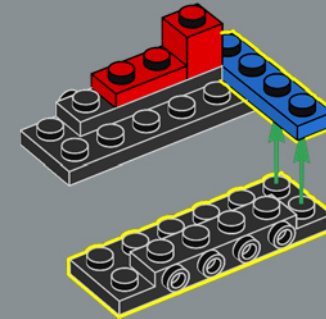

262

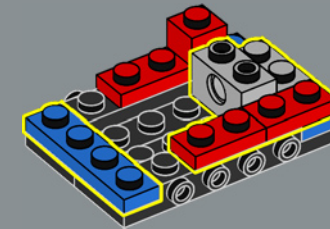

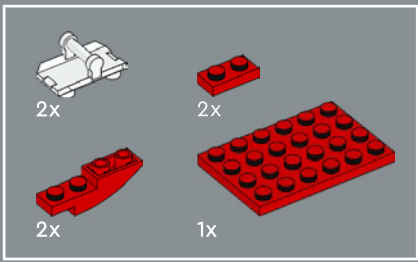

263

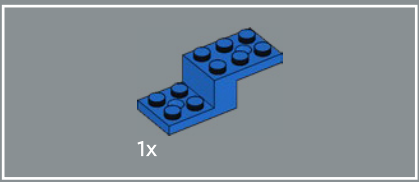
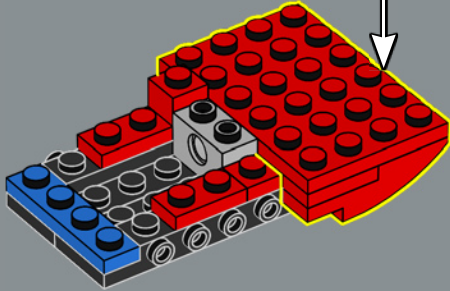
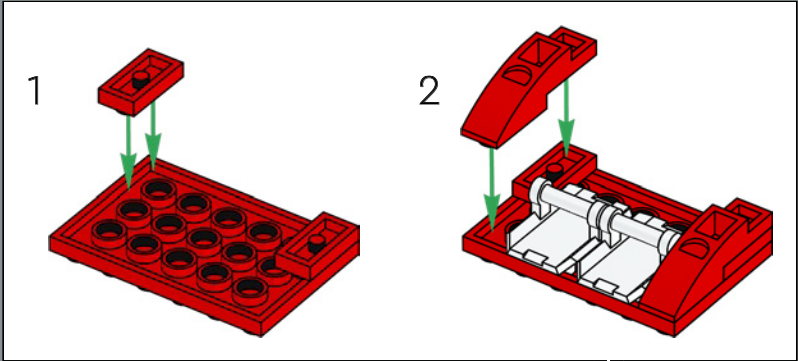

264

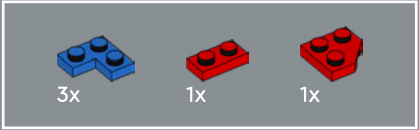
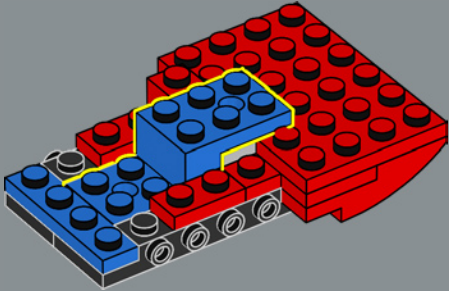

265

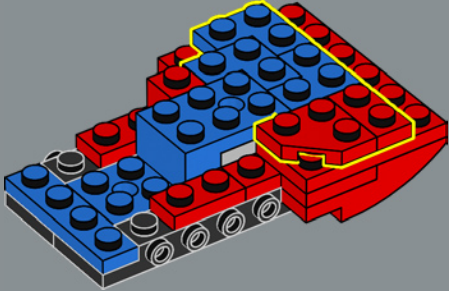

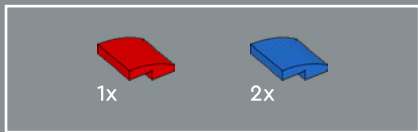

266

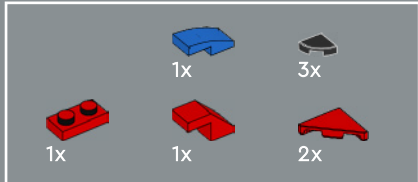
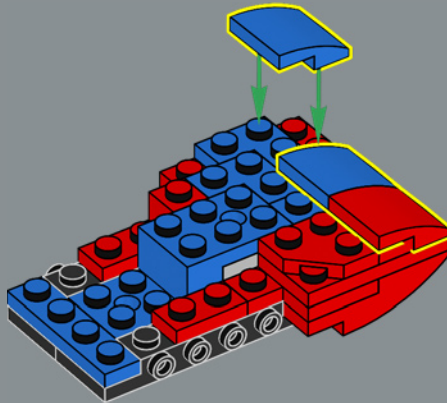

267

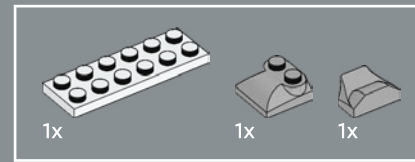
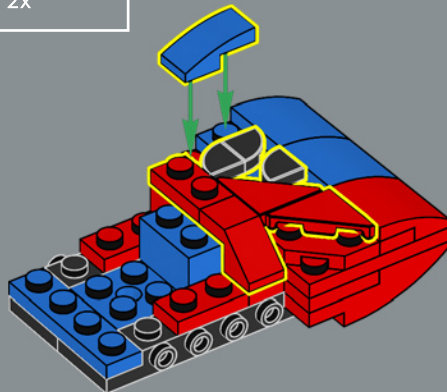

268

Did you know? Spider-Man wears web-shooters on his wrists beneath his costume - they can shoot thin strands of the special web fluid at high pressure.

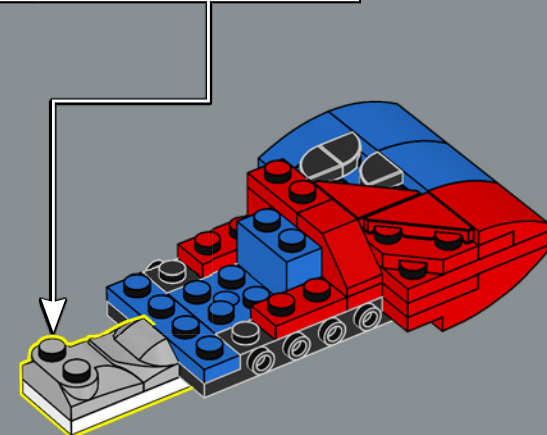
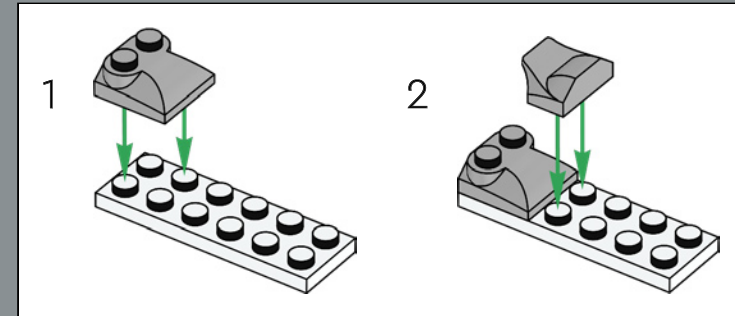

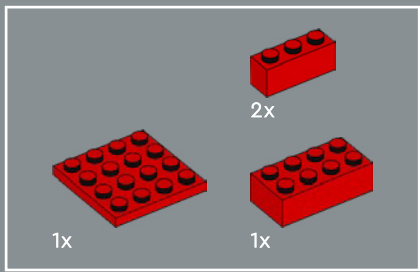

269

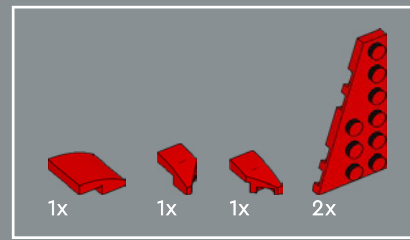
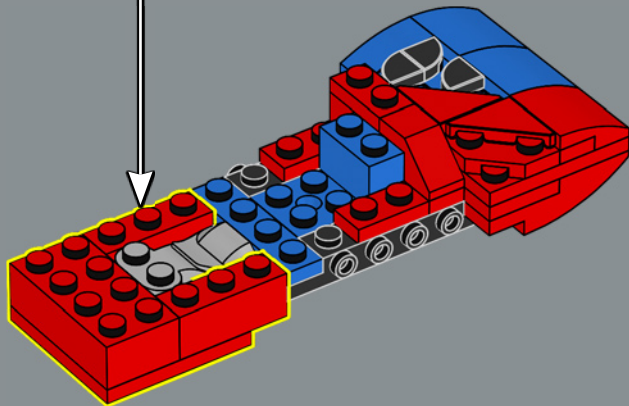
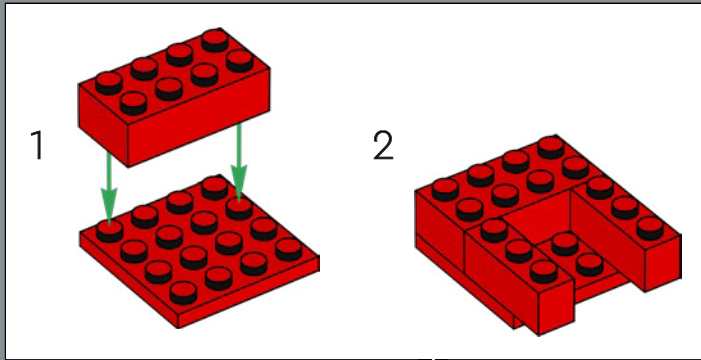

270

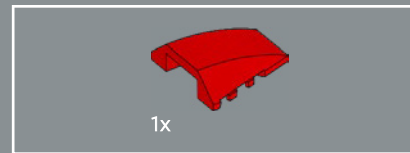
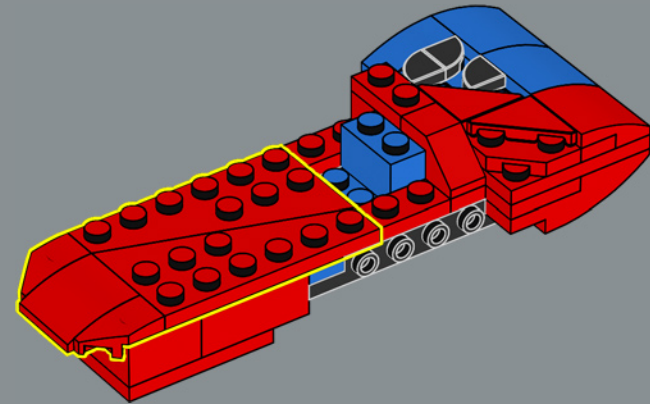

271

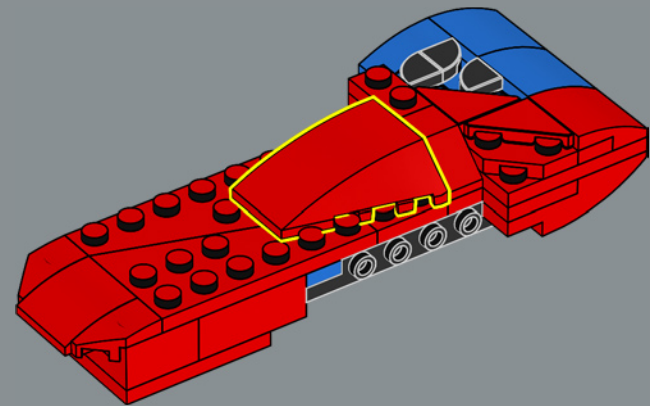

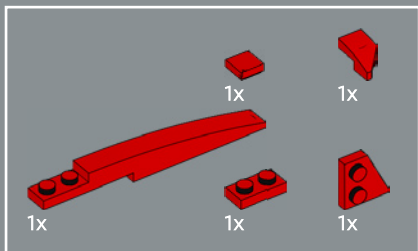

272

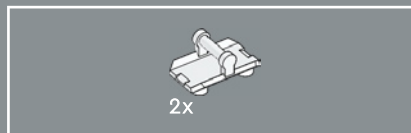
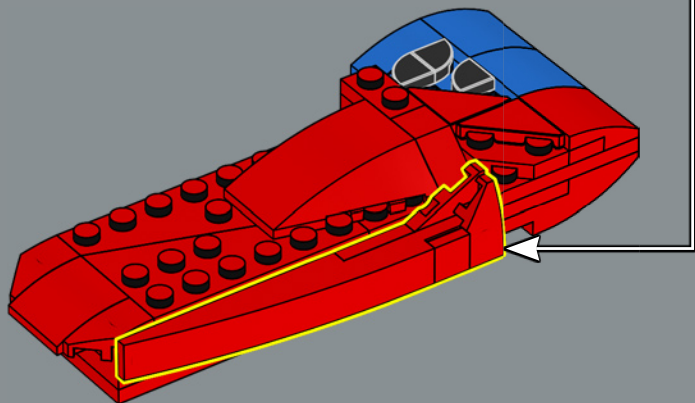
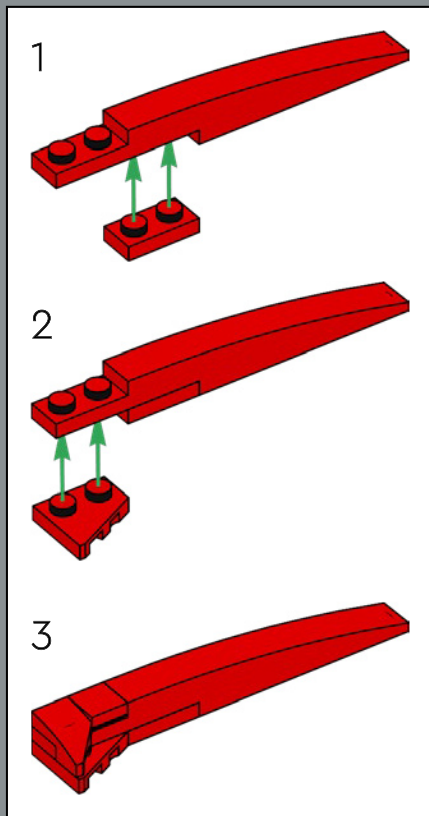

273

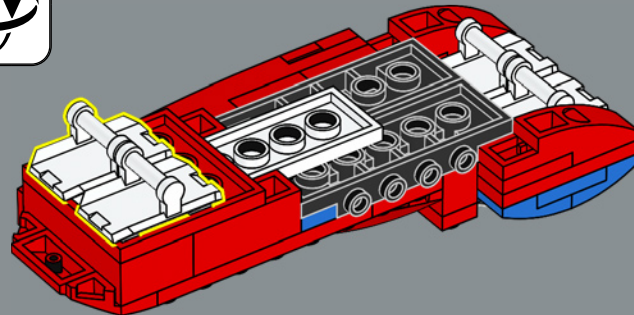

Pythagorean theorem tells us that $A^2 + B^2 = C^2$, meaning that $11^2 + 2^2 = C^2$ and $C = \sqrt{125}$

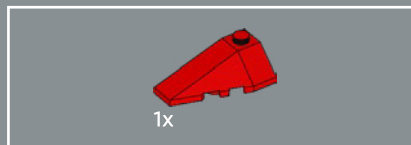

274

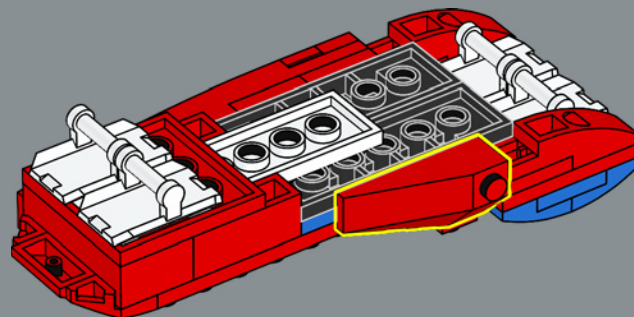

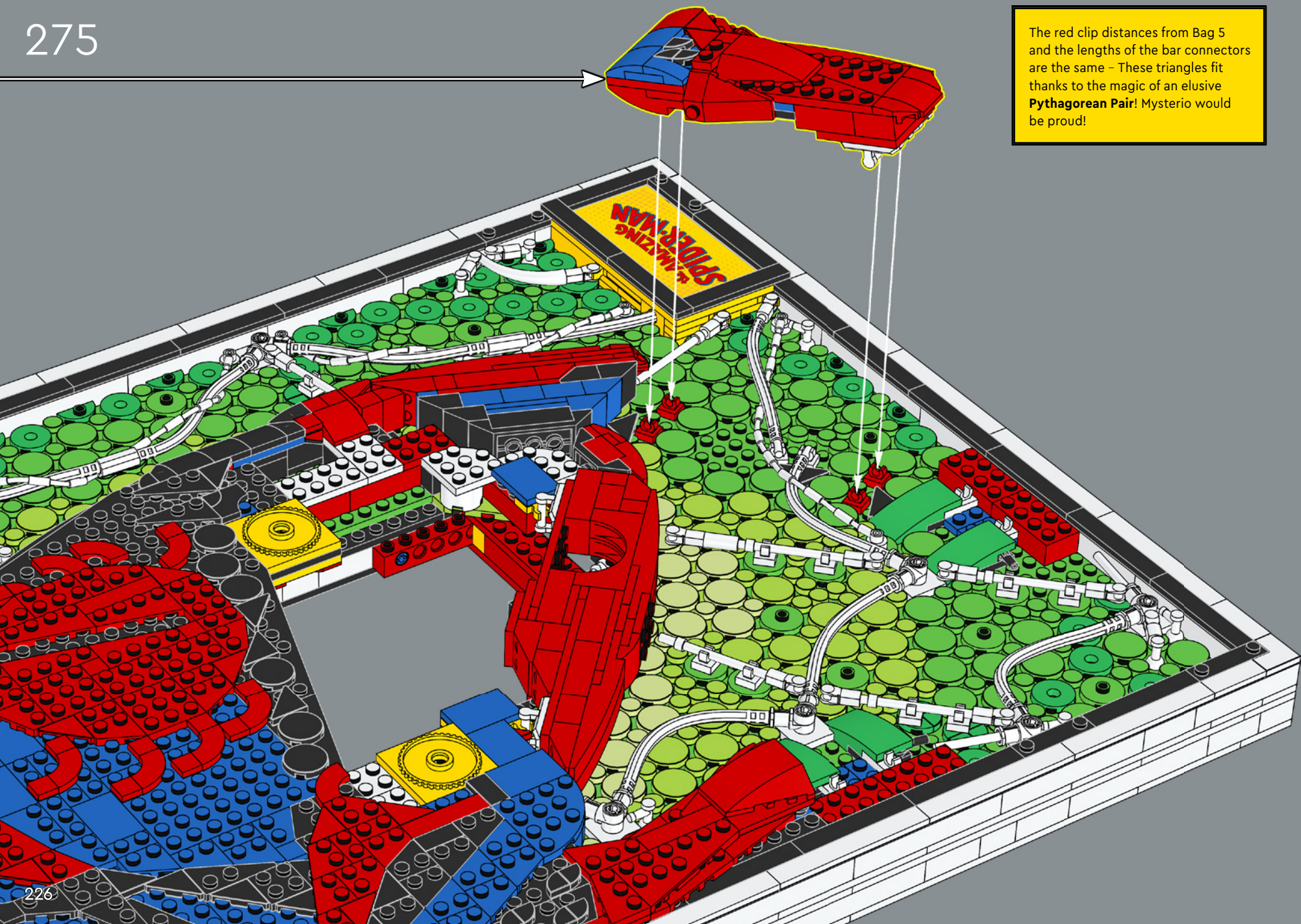

The red clip distances from Bag 5 and the lengths of the bar connectors are the same - These triangles fit thanks to the magic of an elusive **Pythagorean Pair!** Mysterio would be proud!

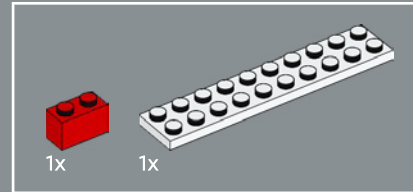
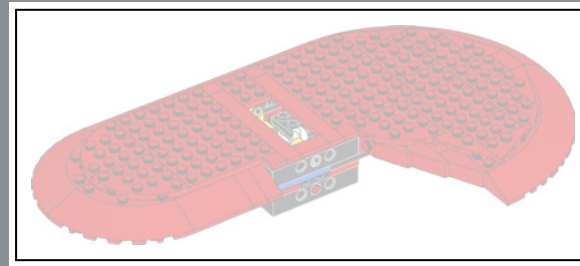
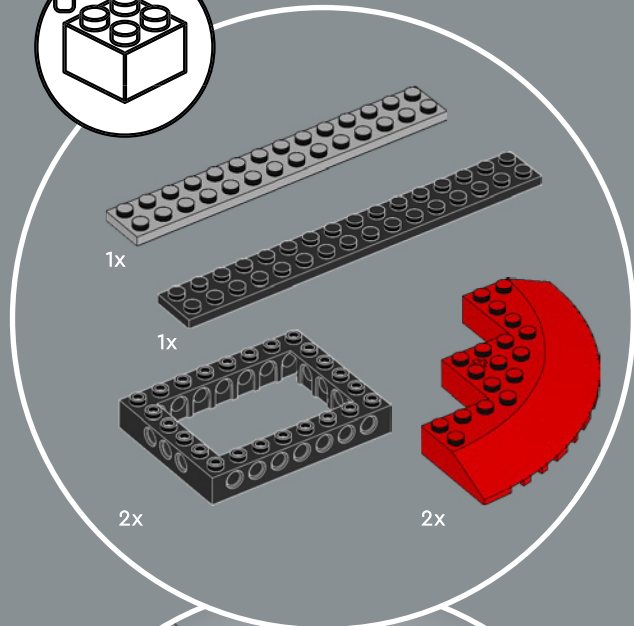
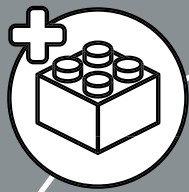

276

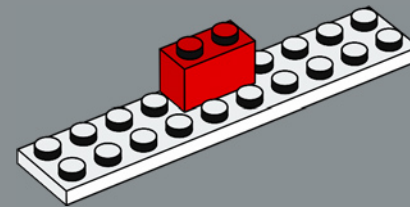

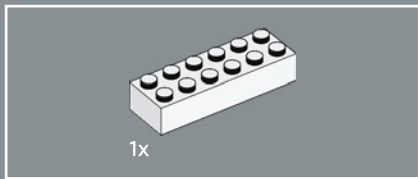

277

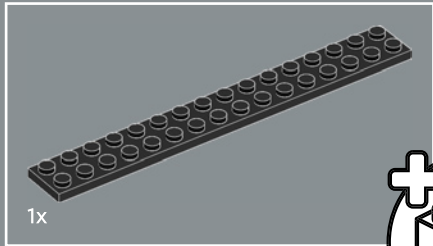
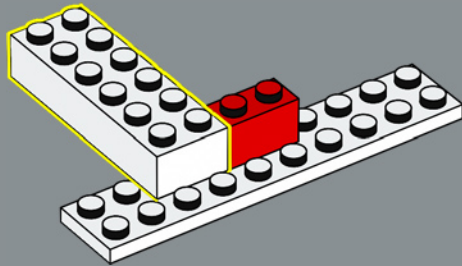

278

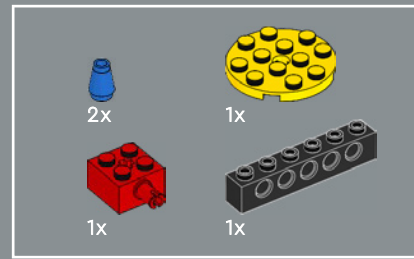
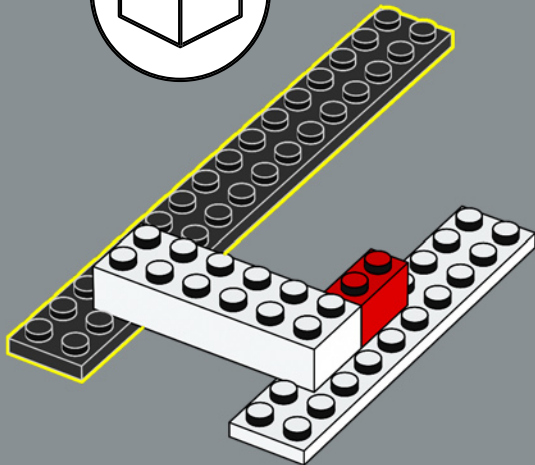
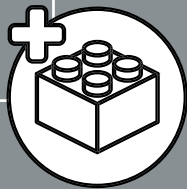

279

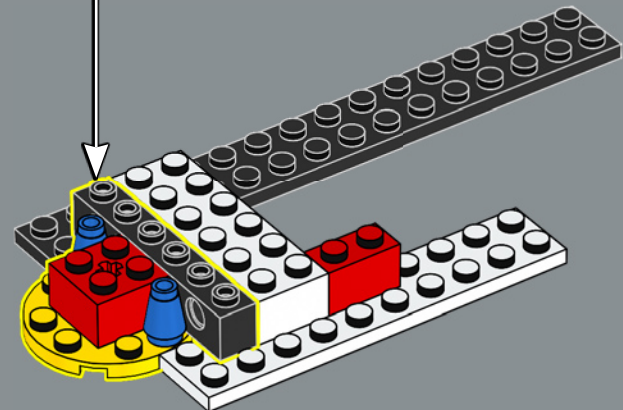
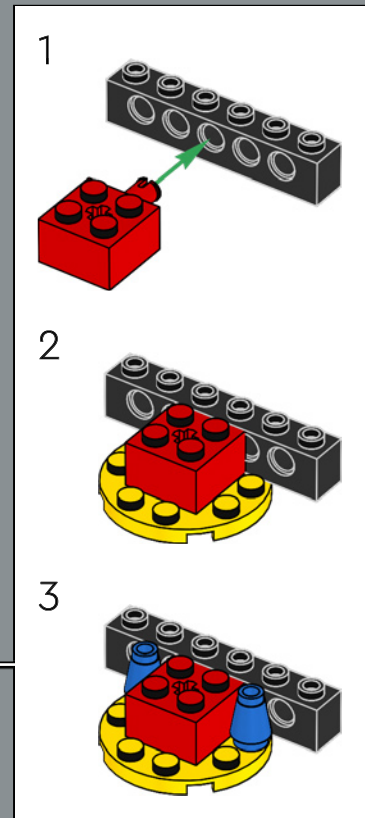

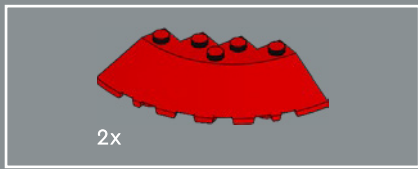

280

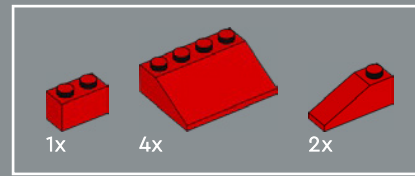
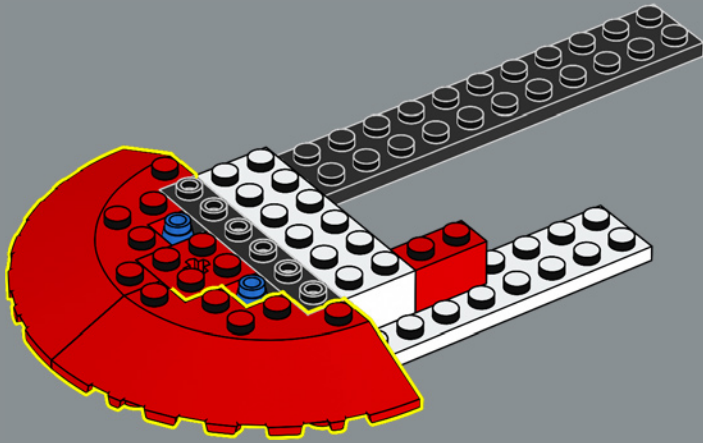

281

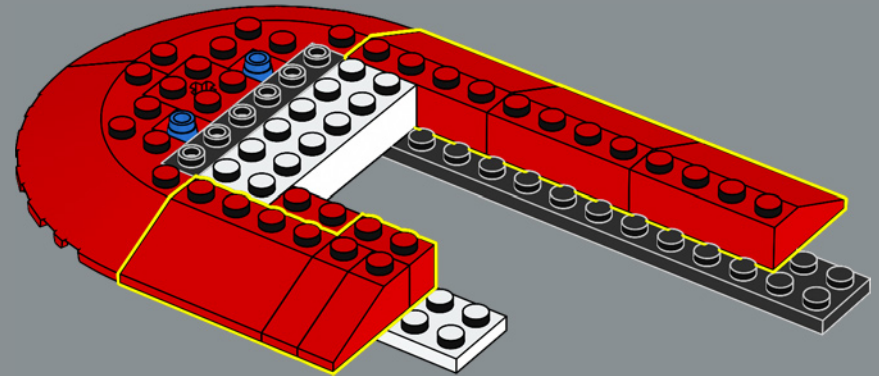

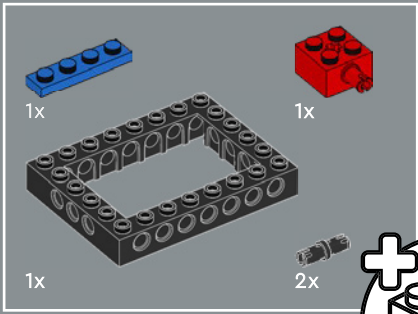

282

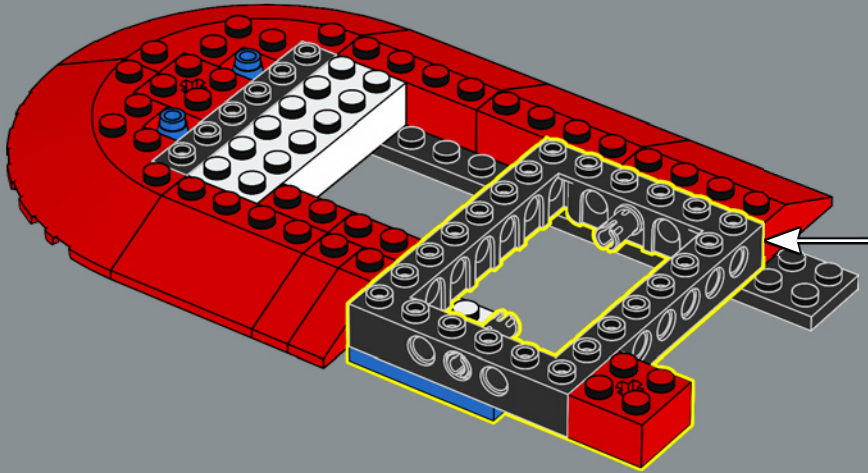
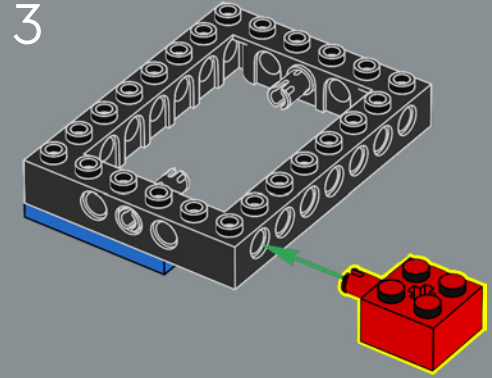
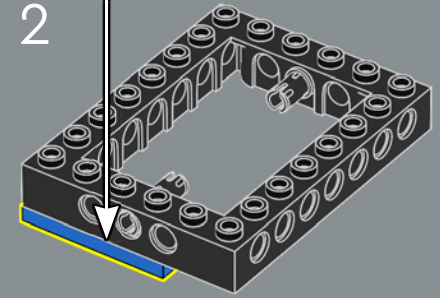
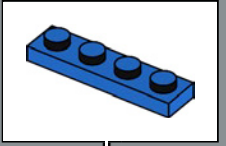
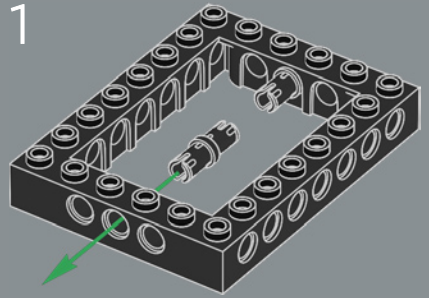

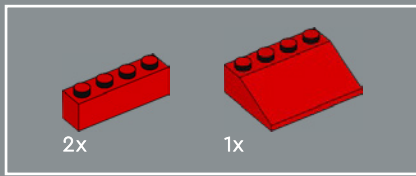

283

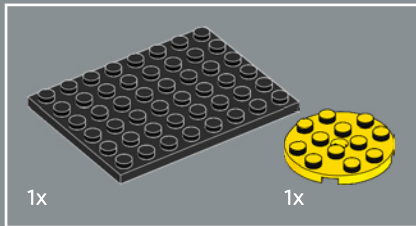
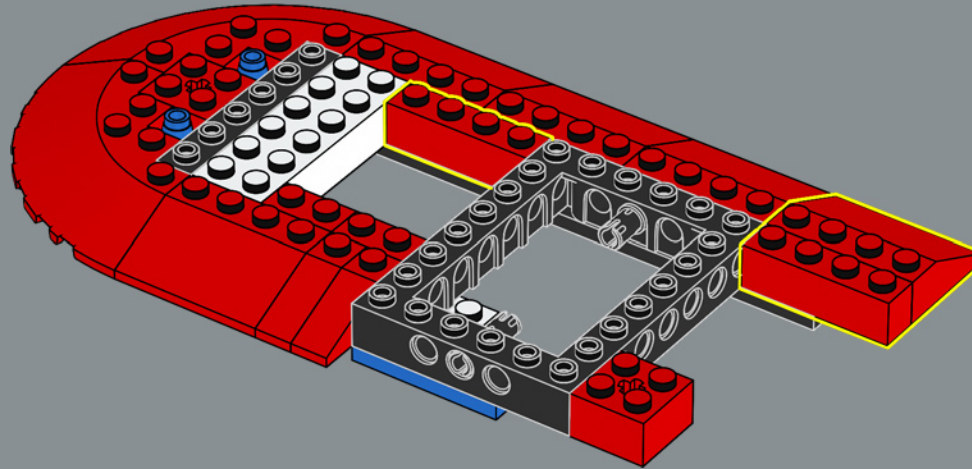

284

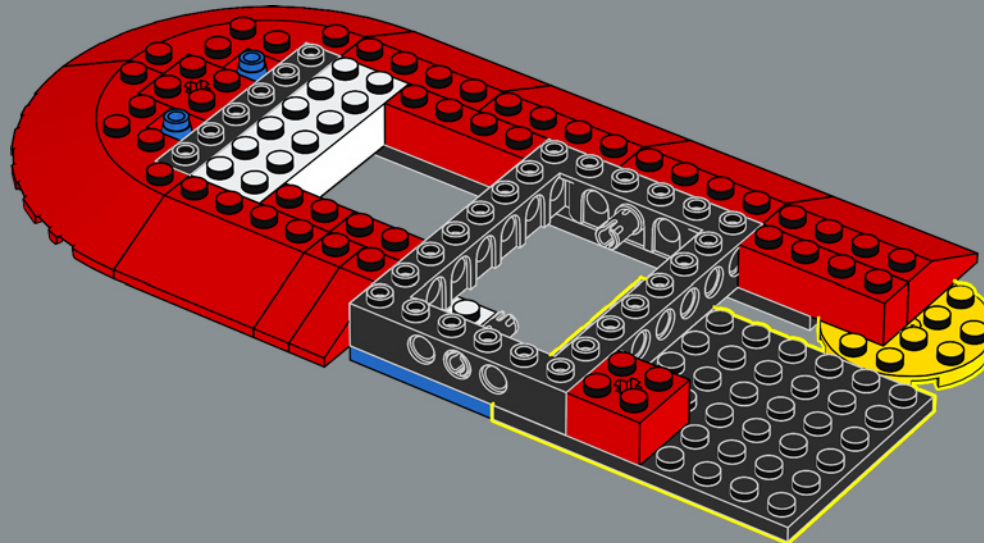

The yellow 4x4 round plates are also placed precisely **18 across** and **3 down** ... Correct guesses as to the purpose might be awarded a prestigious No-Prize.

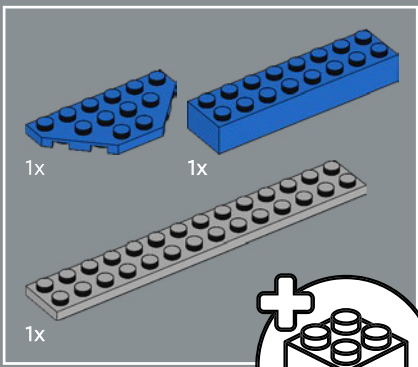

285

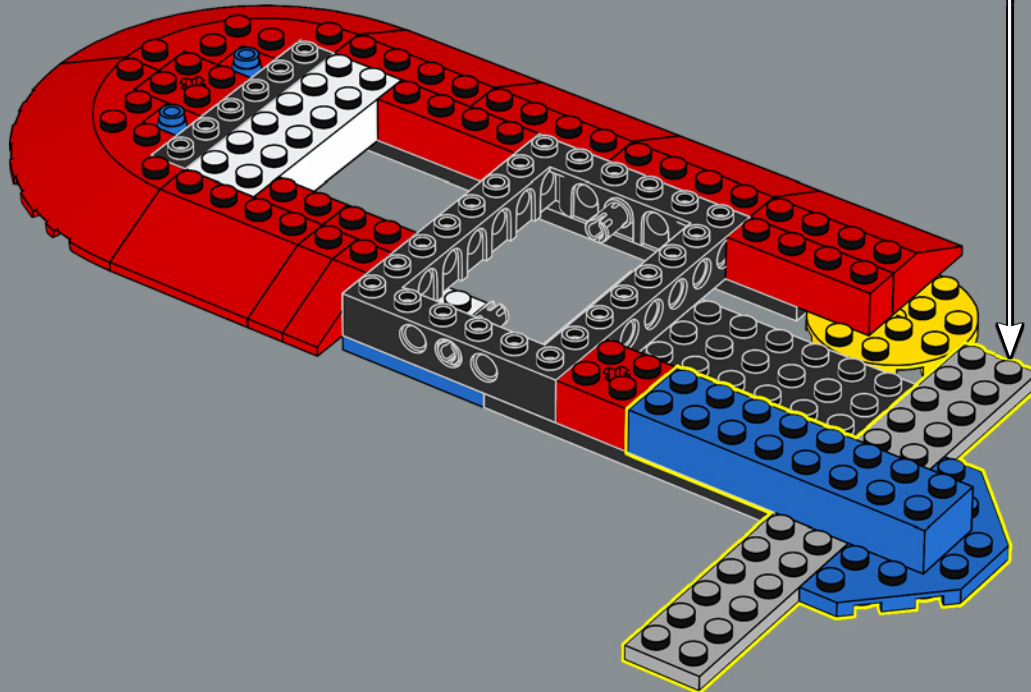
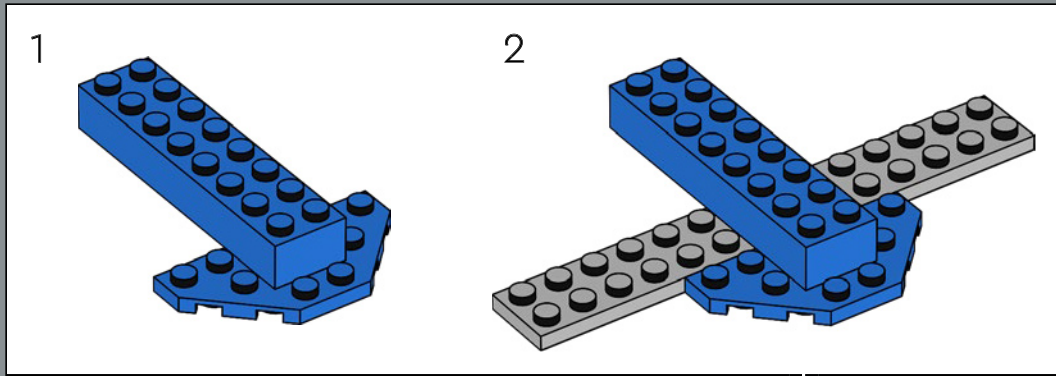

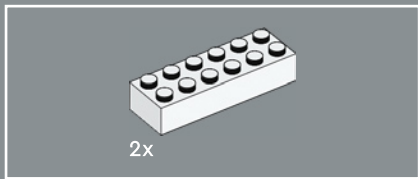

286

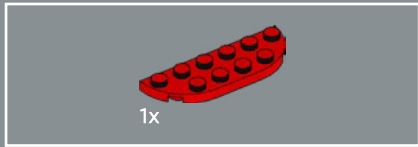
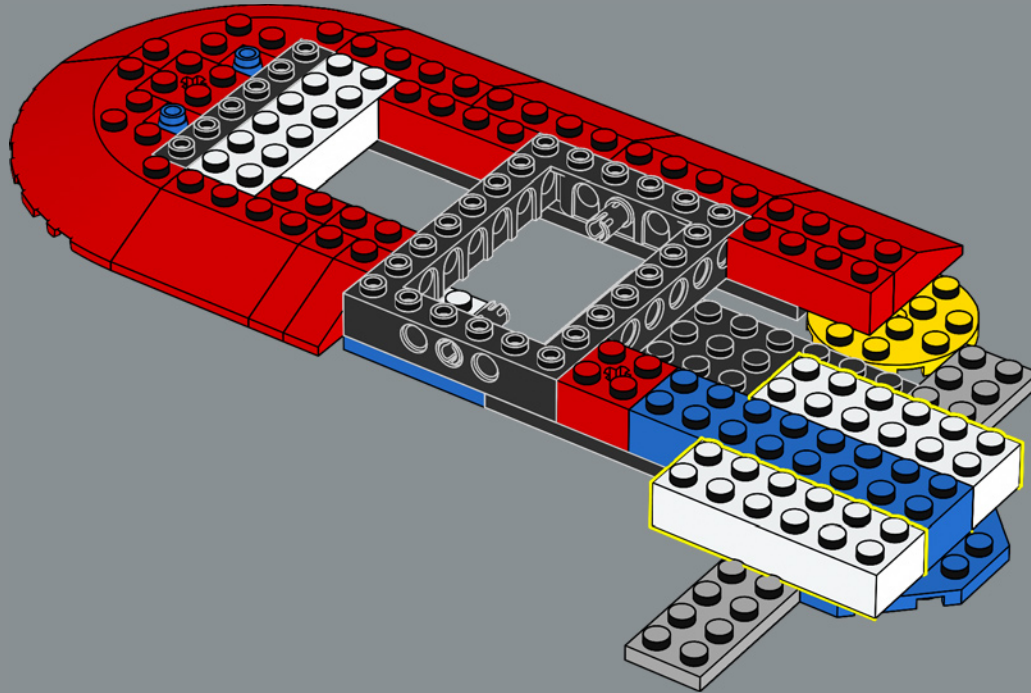

287

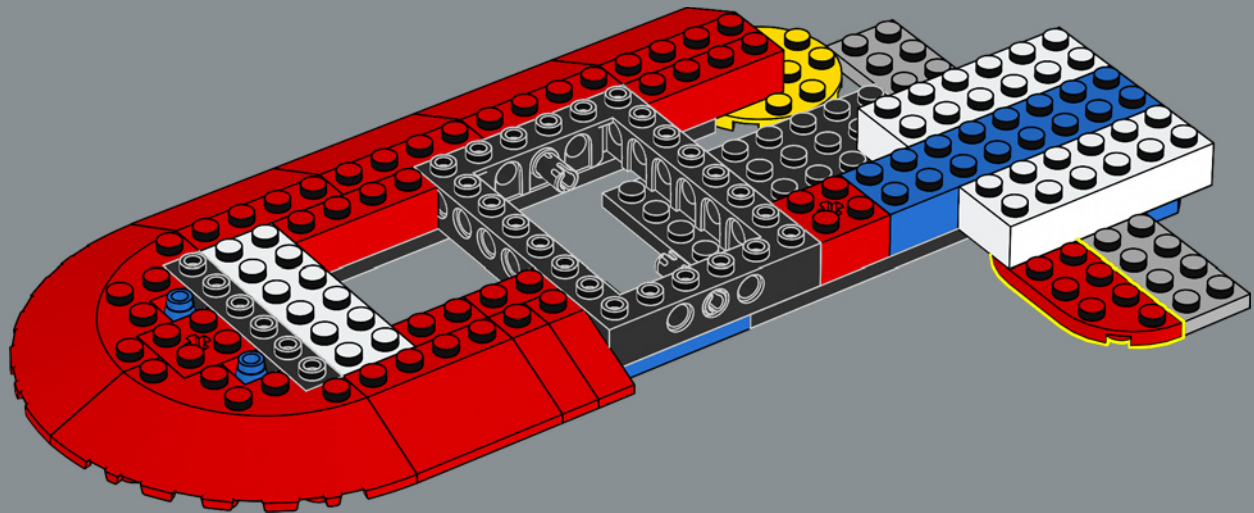

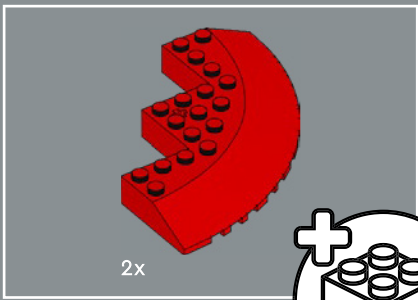

2x

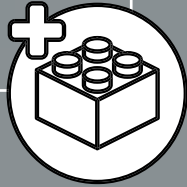

288

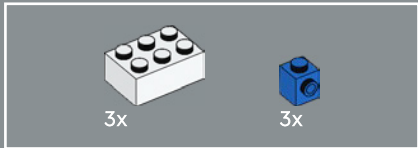
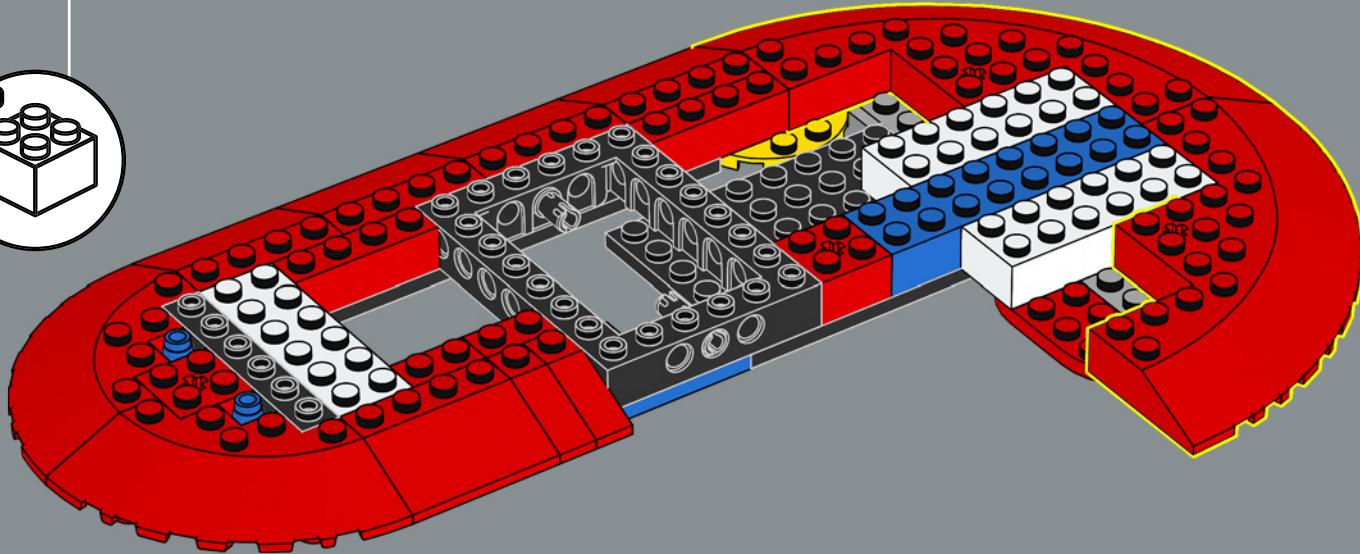

3x

3x

289

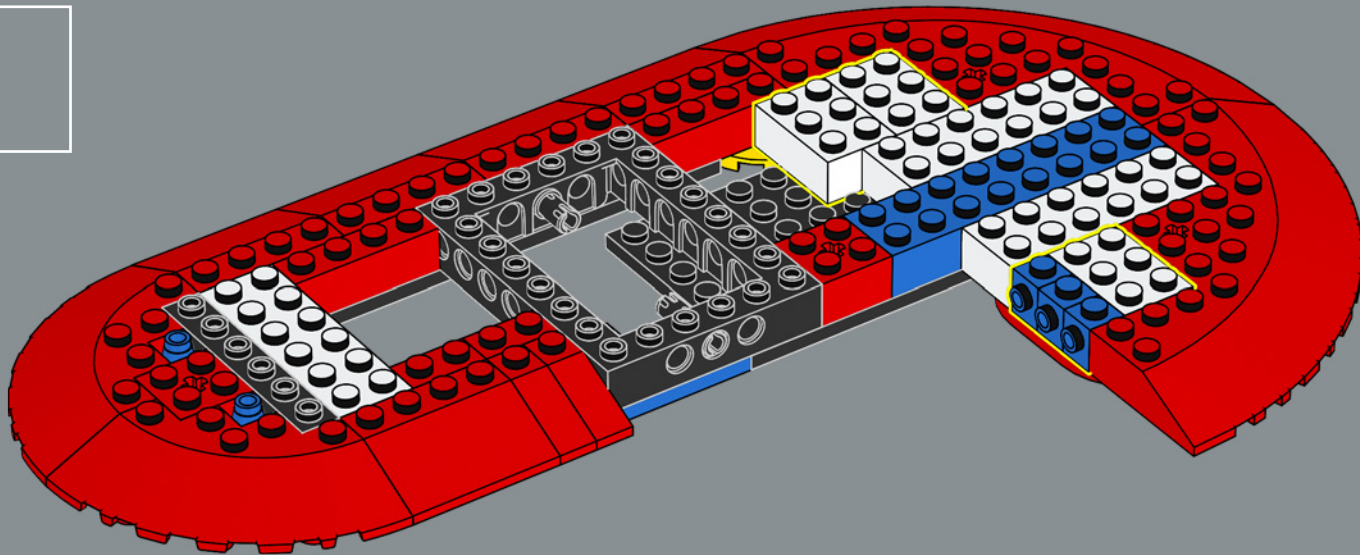

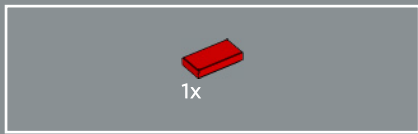

290

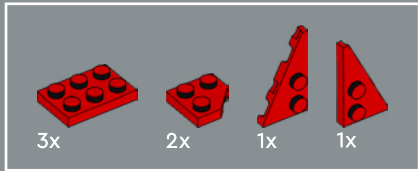
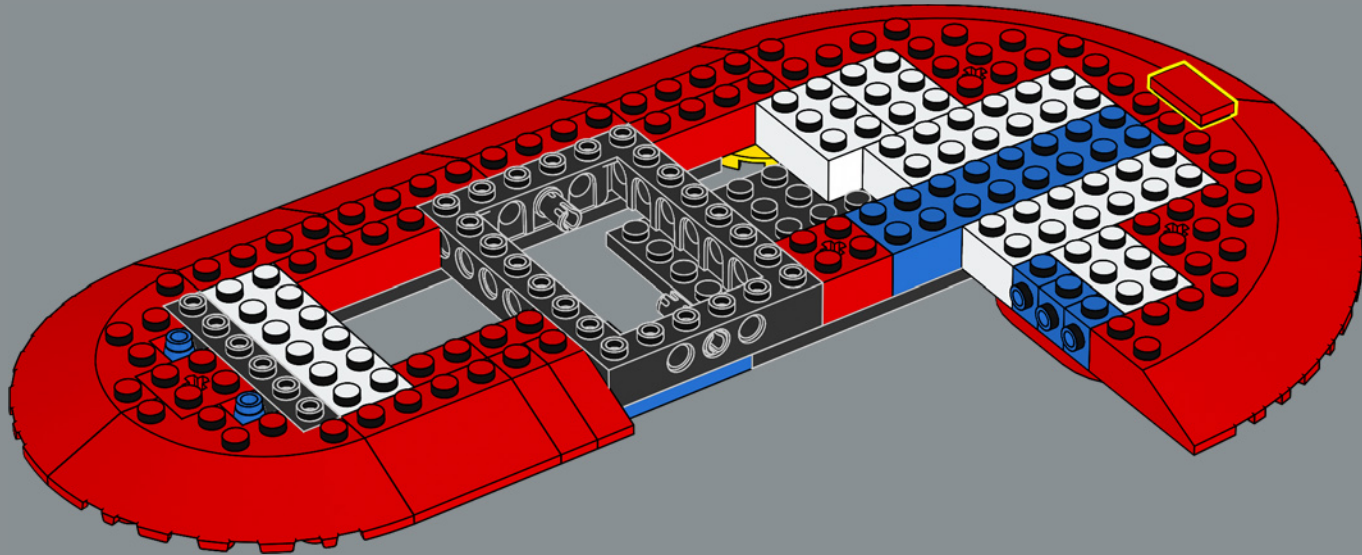

291

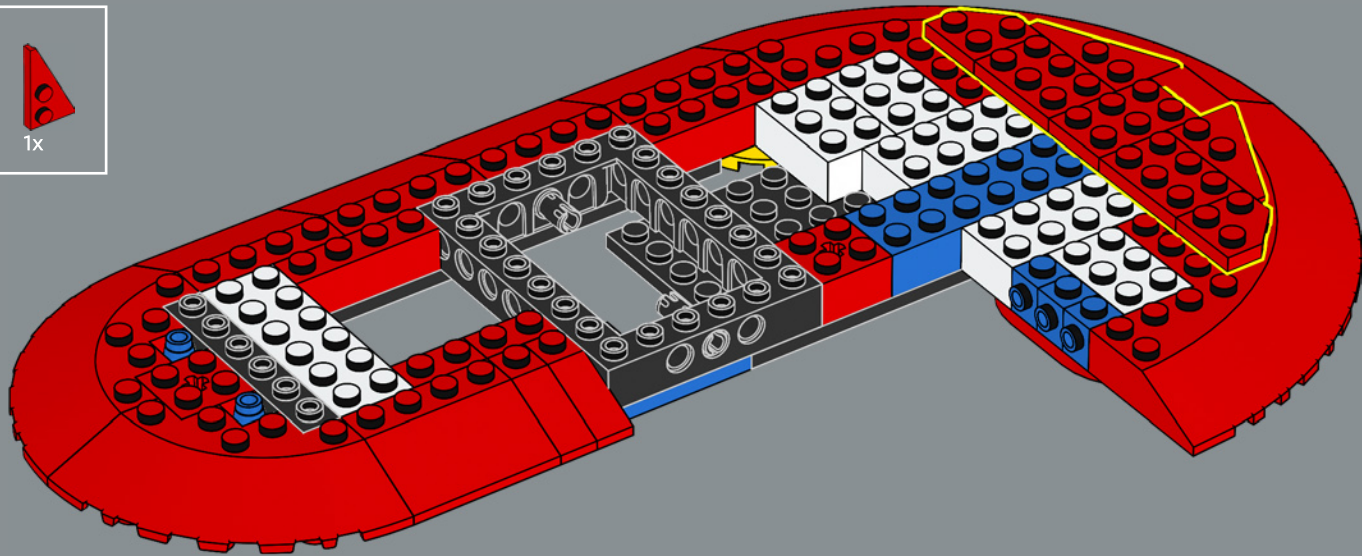

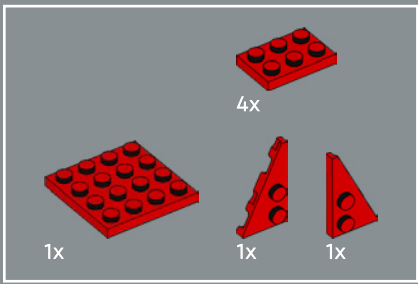

292

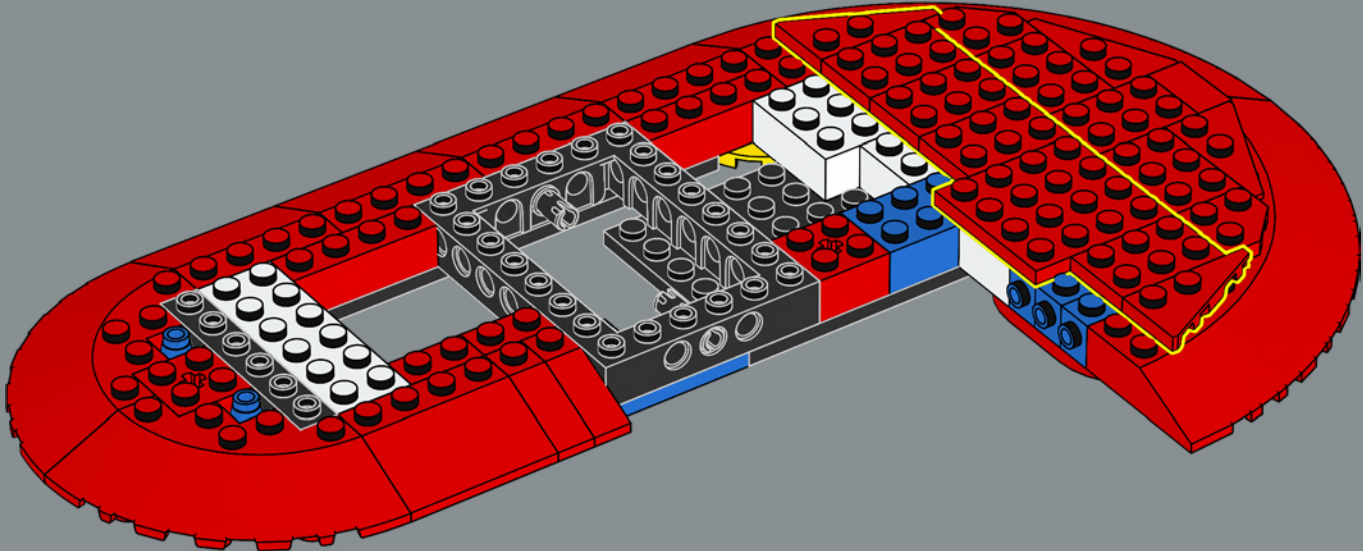

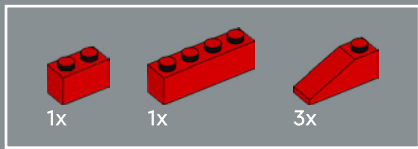

293

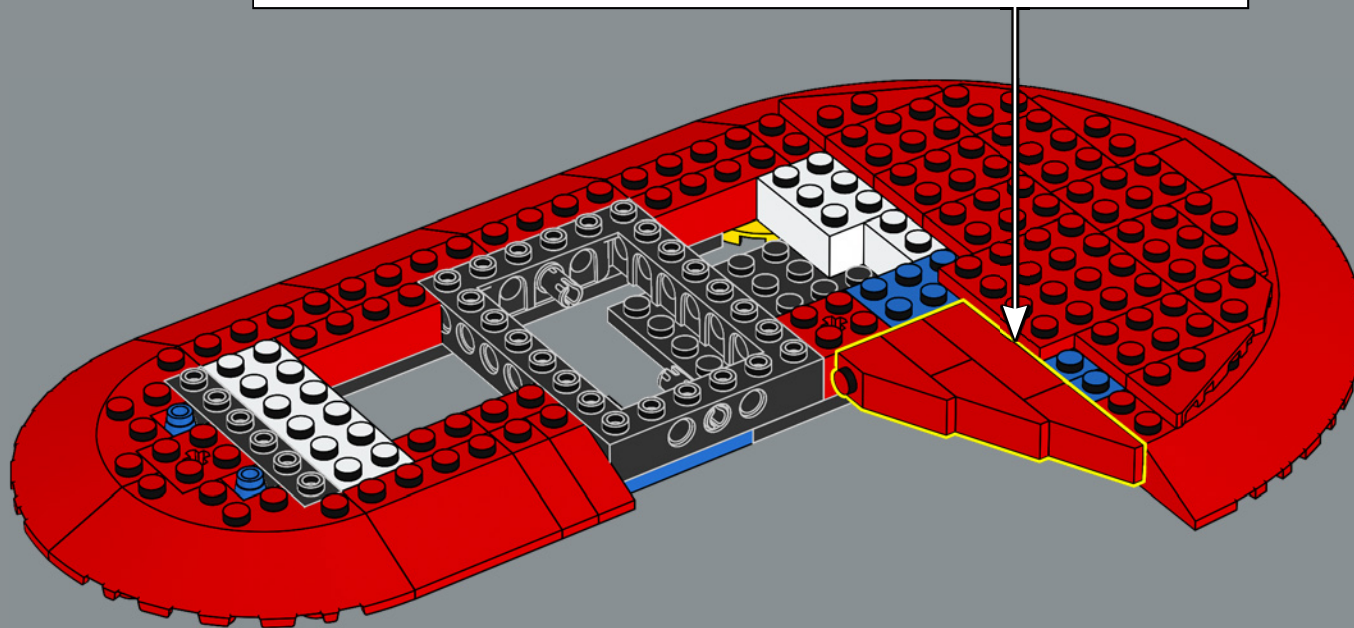
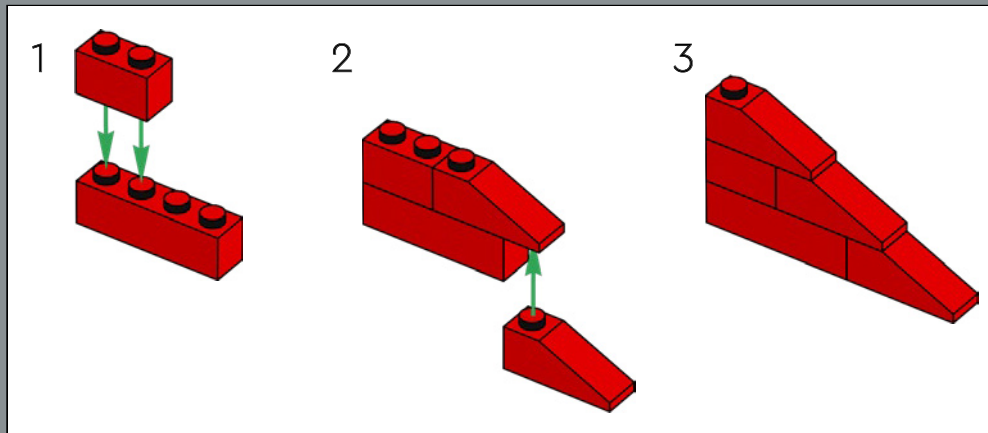

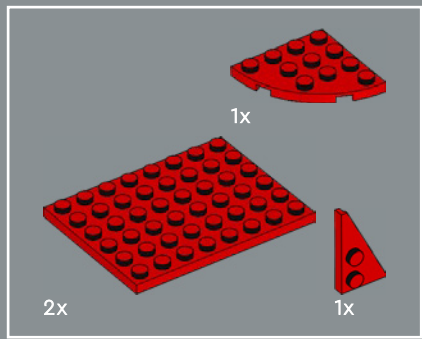

294

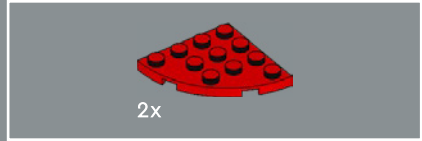
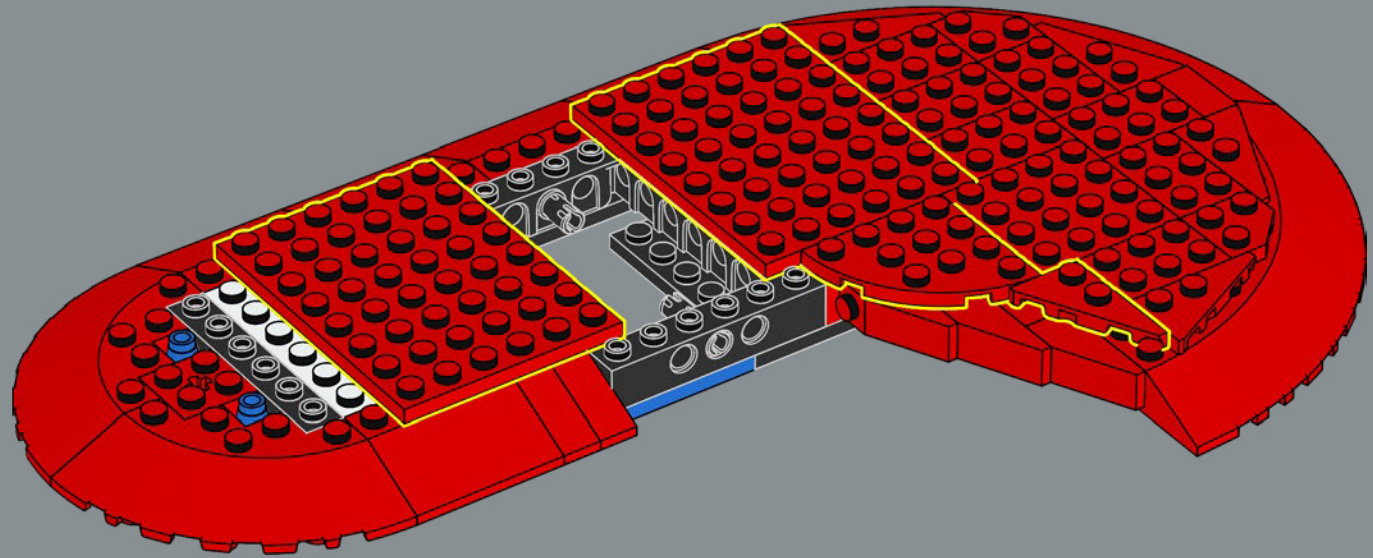

295

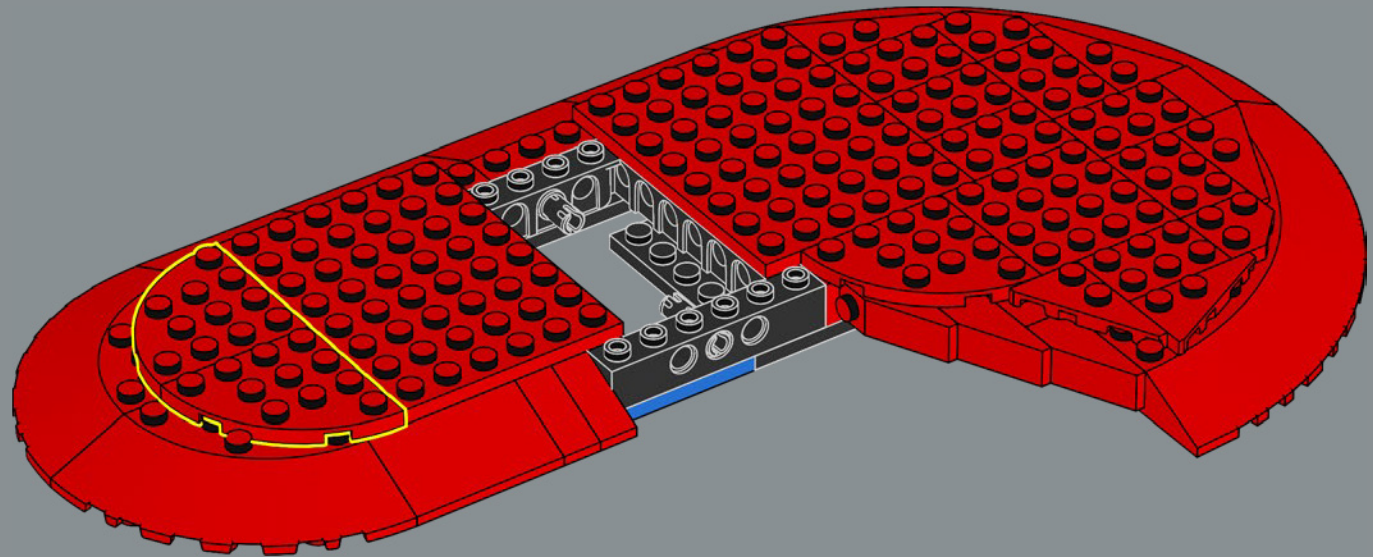

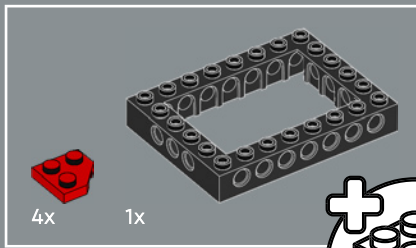

296

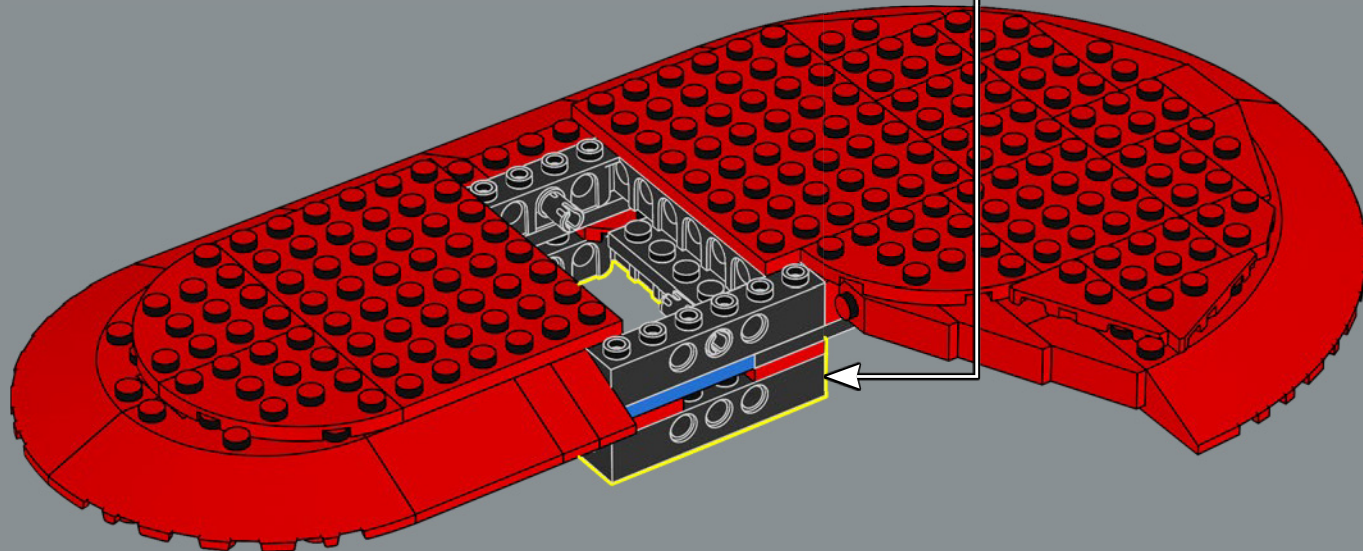
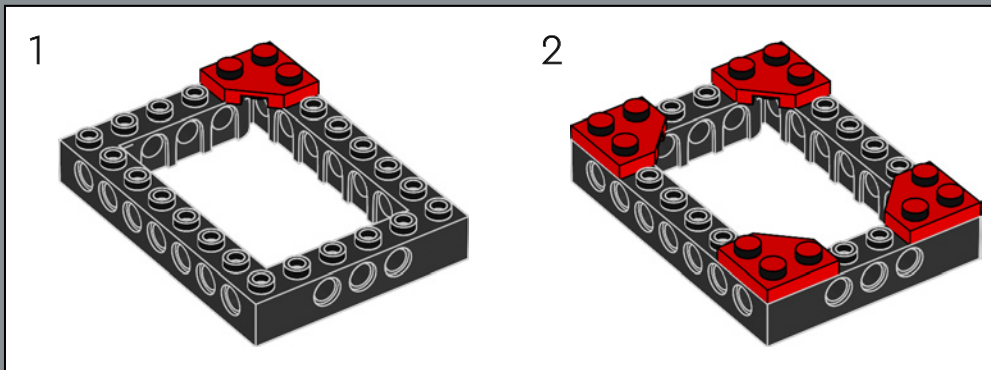
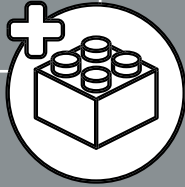

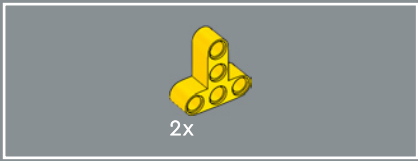

The Marvel No-Prize was pioneered by Stan Lee in the 1960s as a recognition for spotting continuity errors in the comics. Today, the prize is awarded for charitable works and "meritorious service to Marvel above and beyond the call of duty."

297

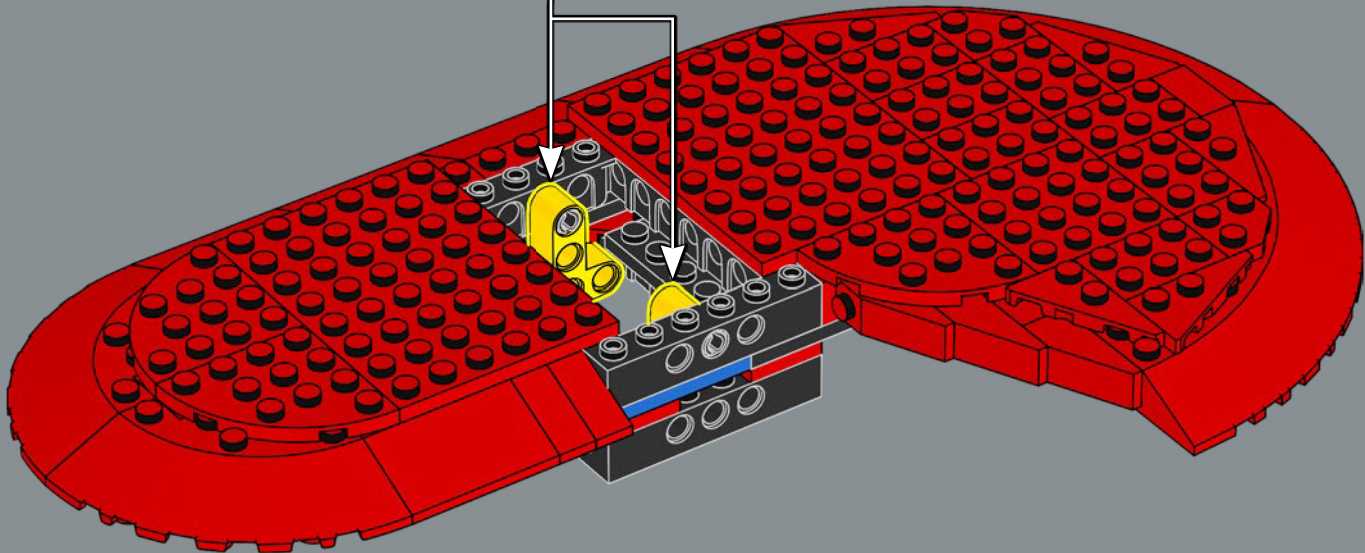
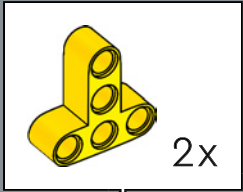

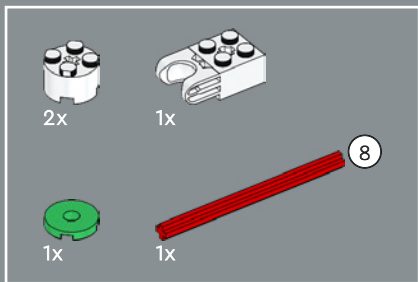

298

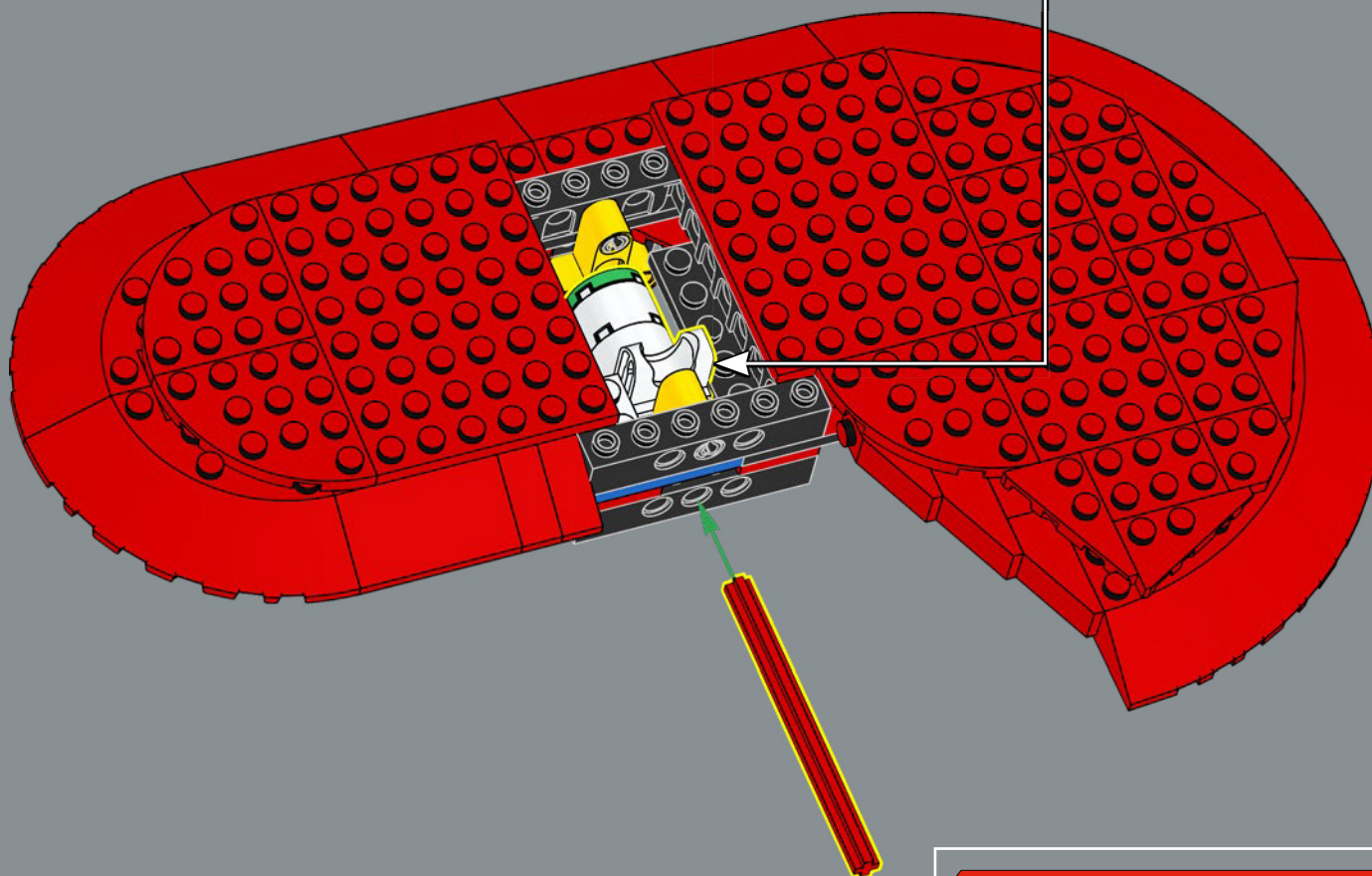
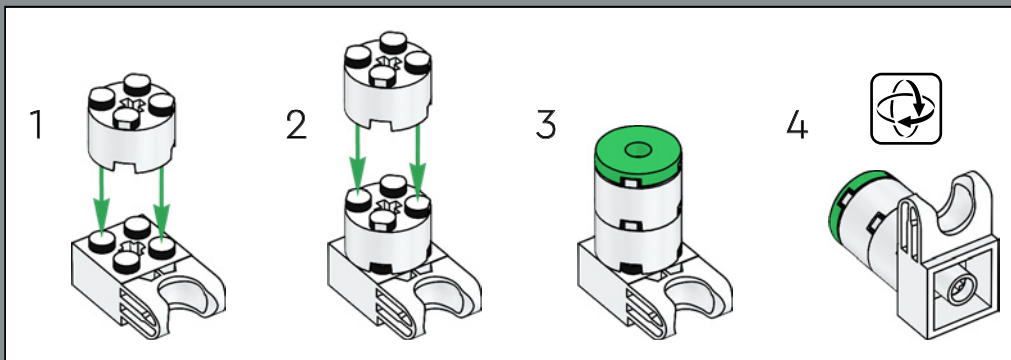

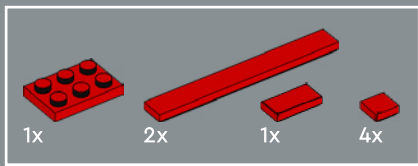

299

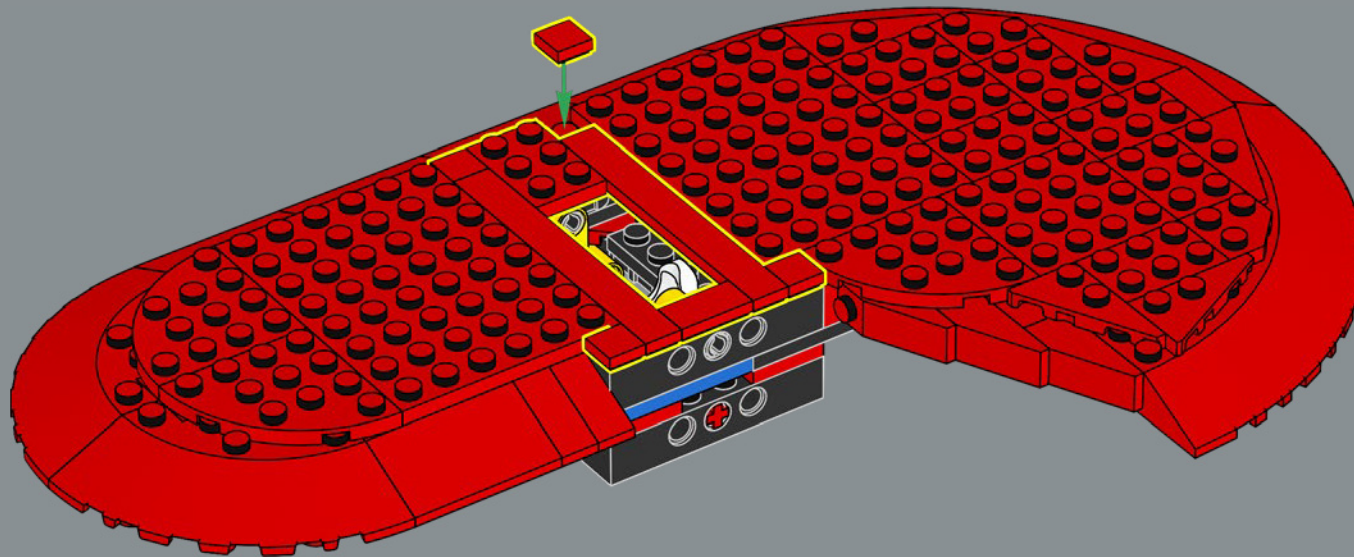

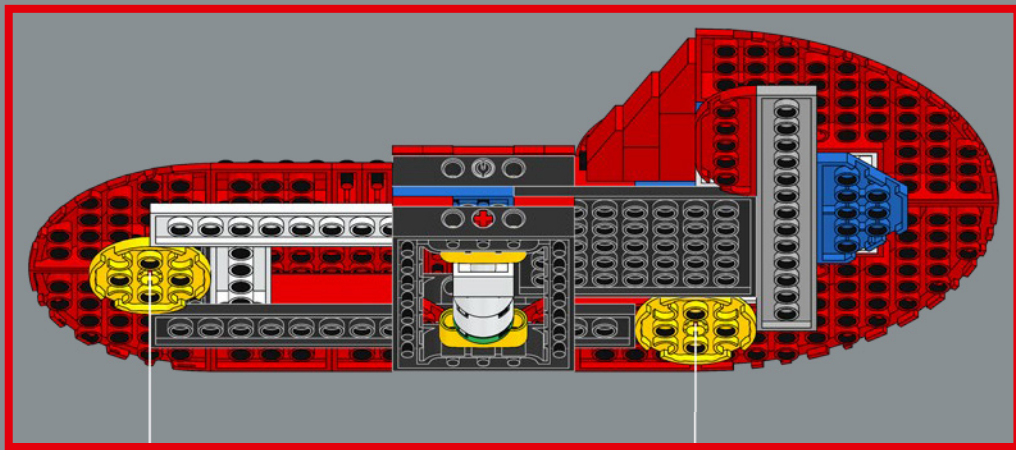

300

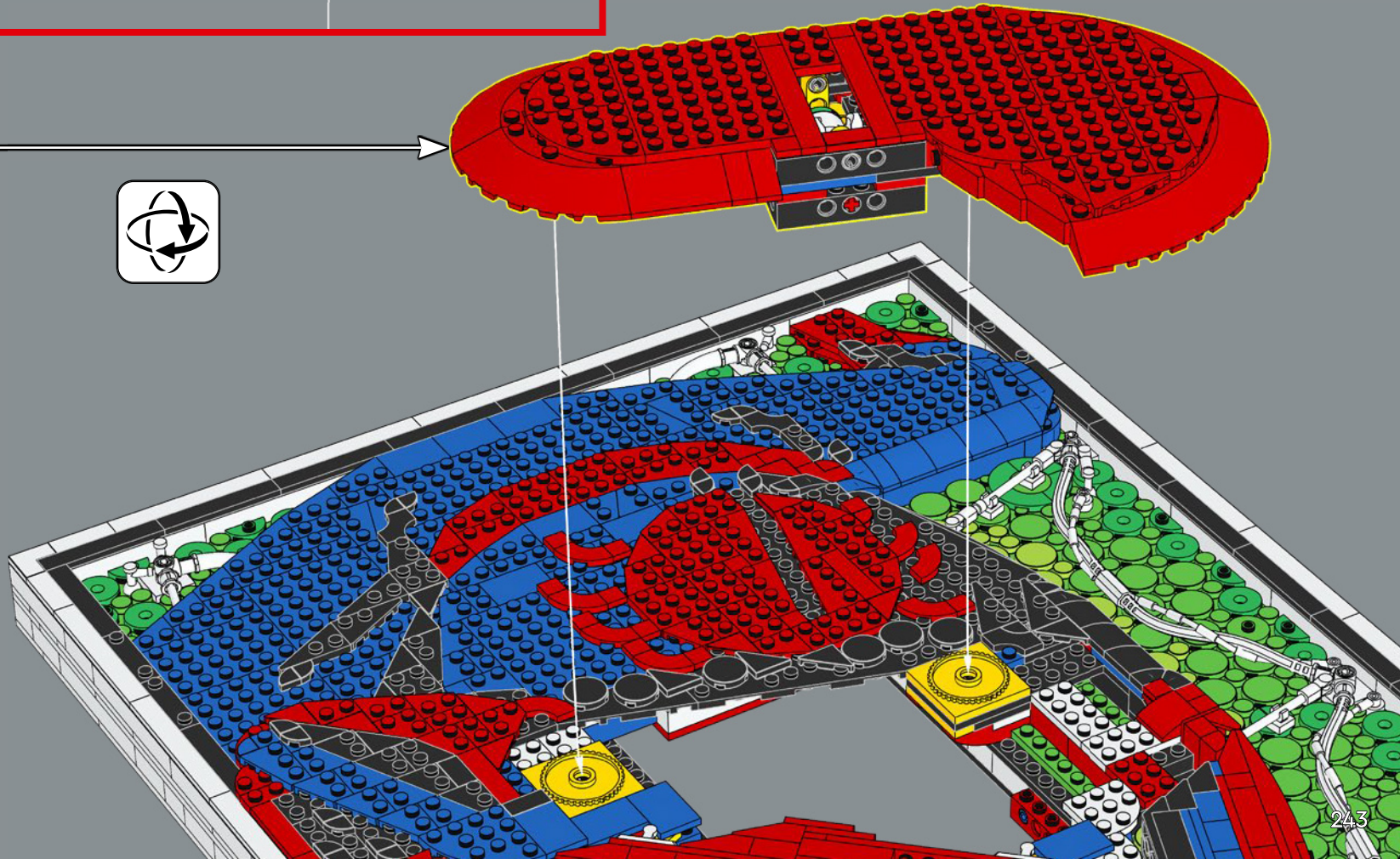

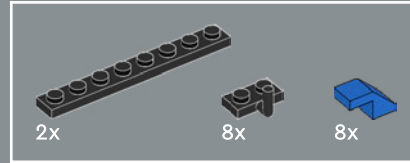
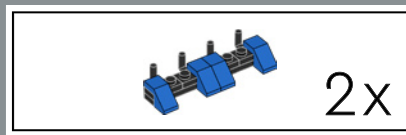

301

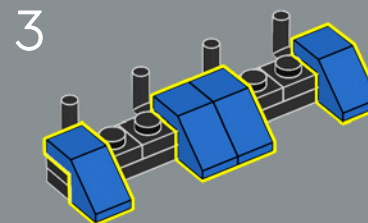
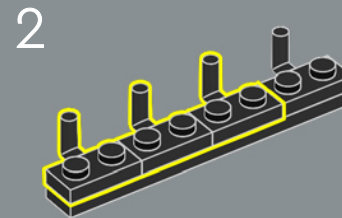
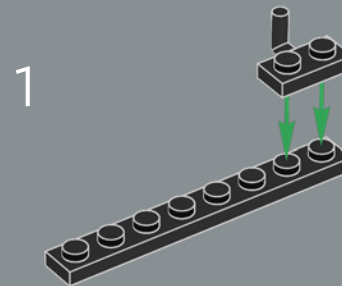

2x

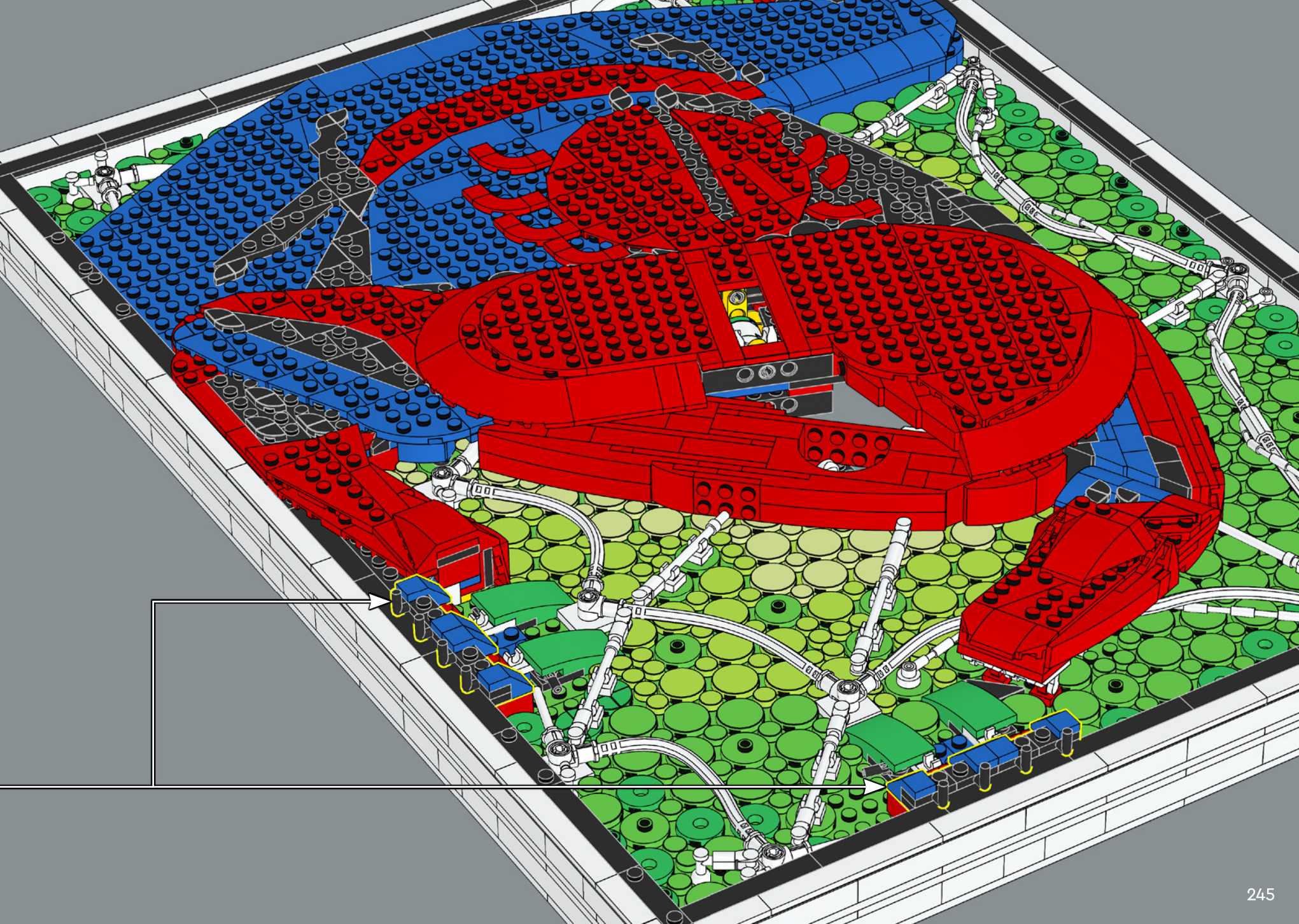

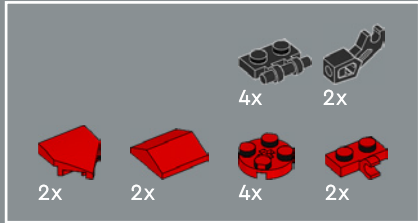
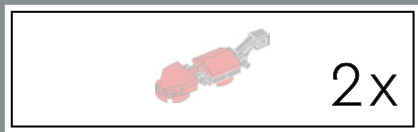

302

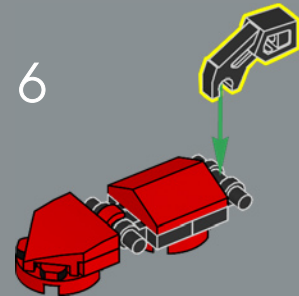
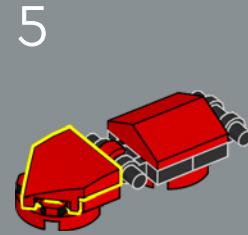
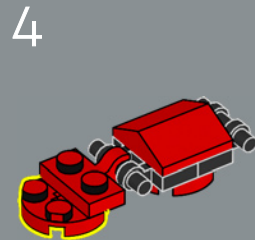
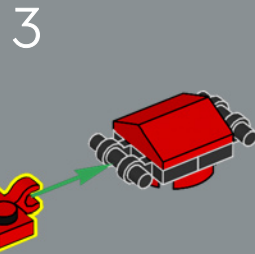
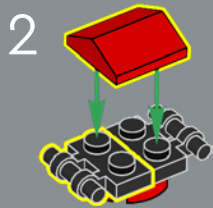
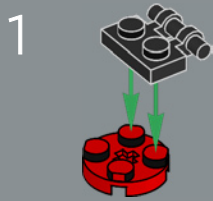

2x

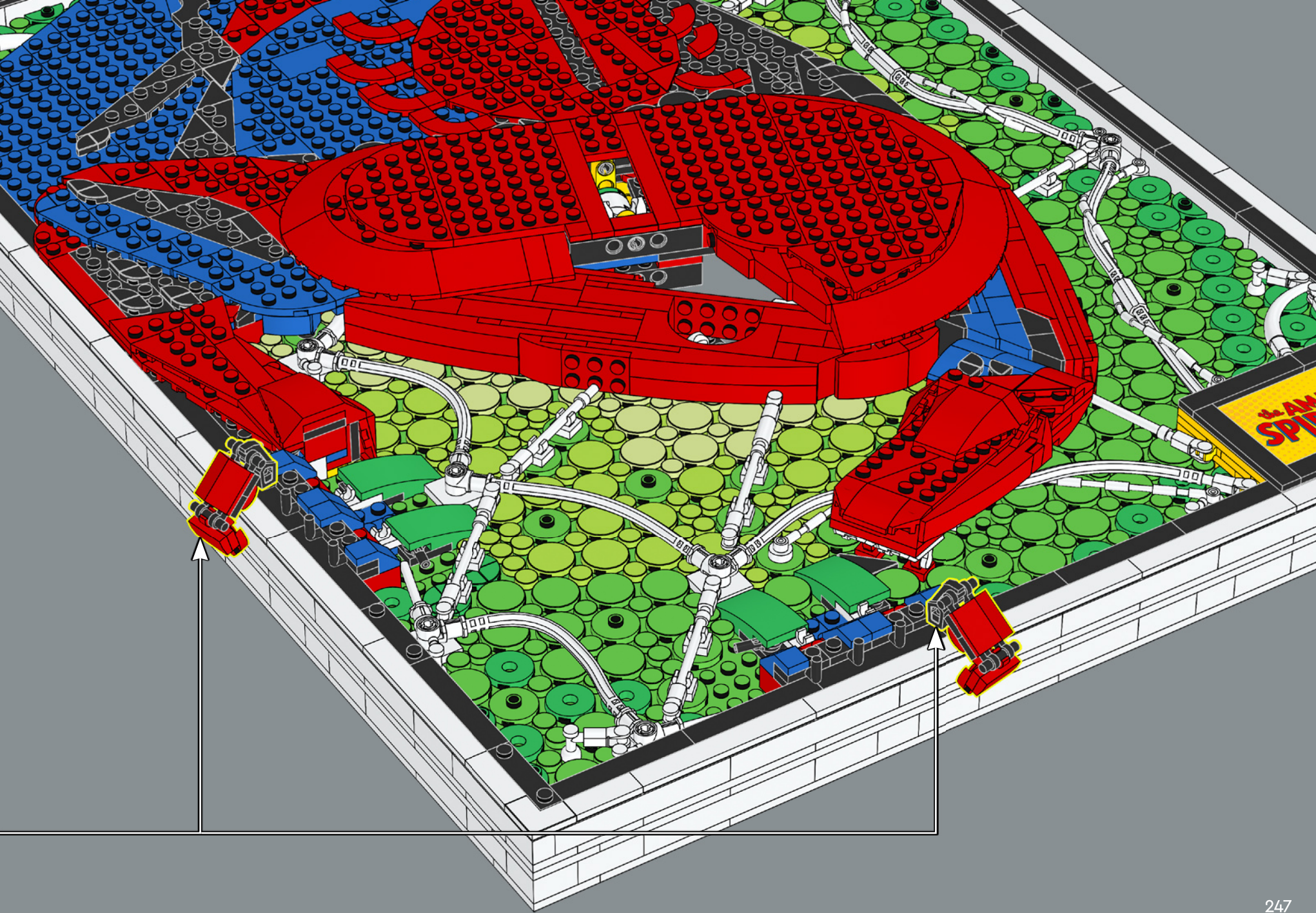

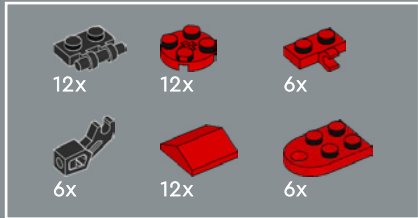
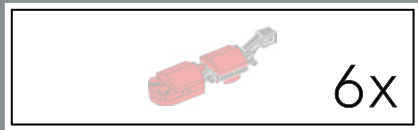

303

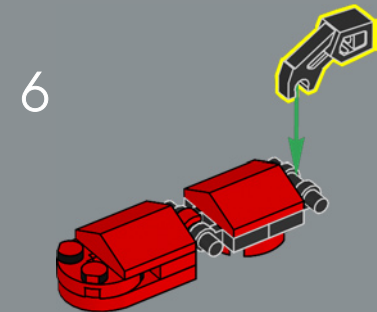
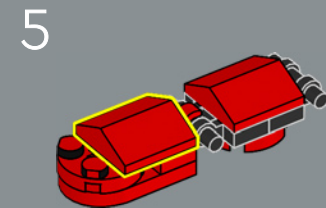
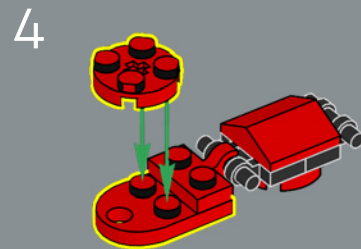
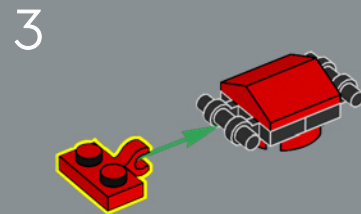
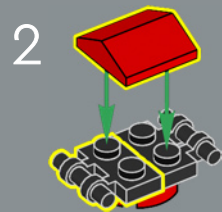
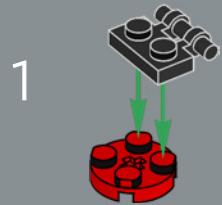

6x

Spider-Man's exposure to mutated spider venom allows him to mentally control the flux of interatomic attraction between molecular boundary layers. Put simply, he can crawl on walls!

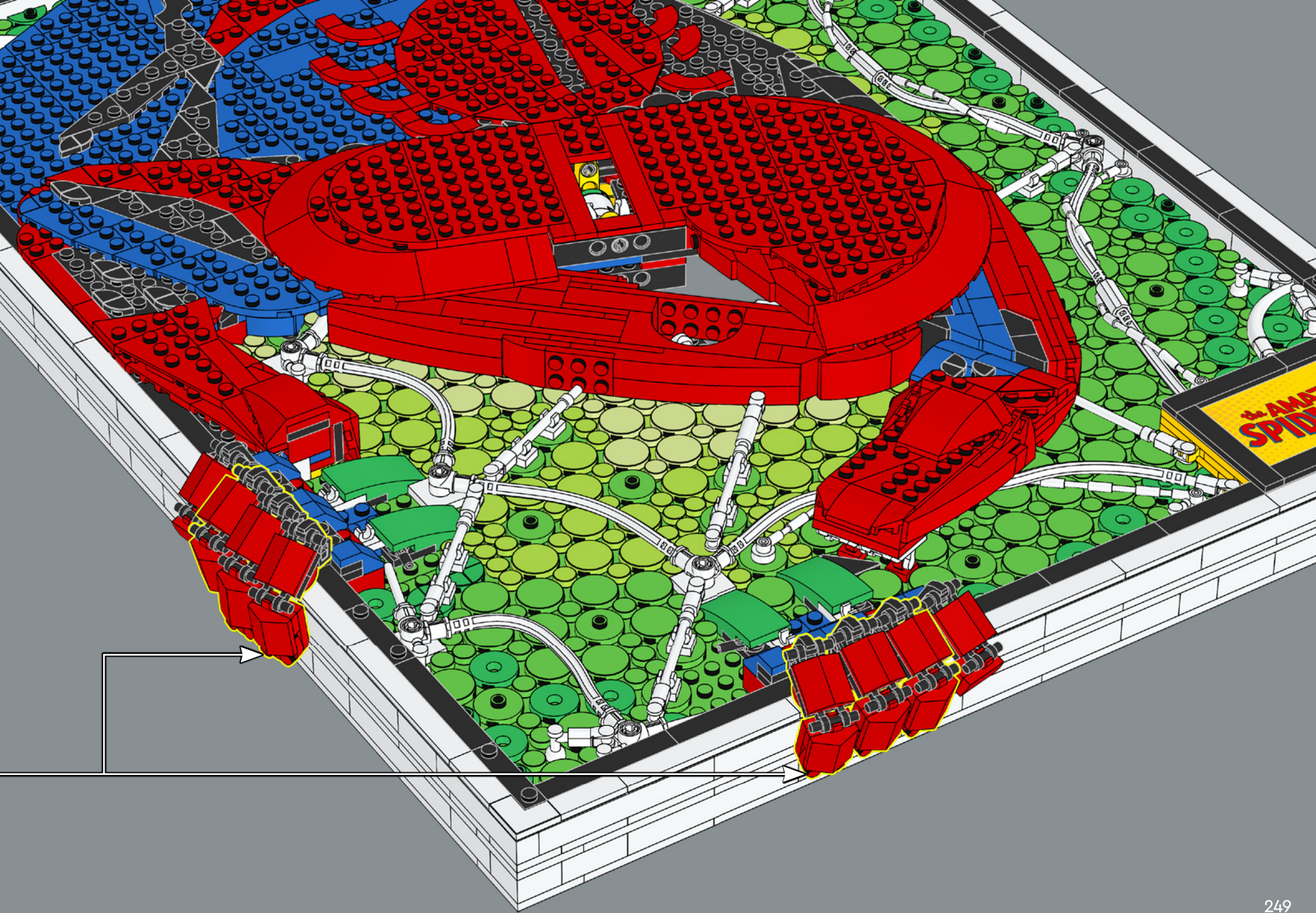

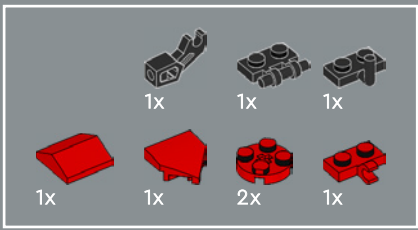

304

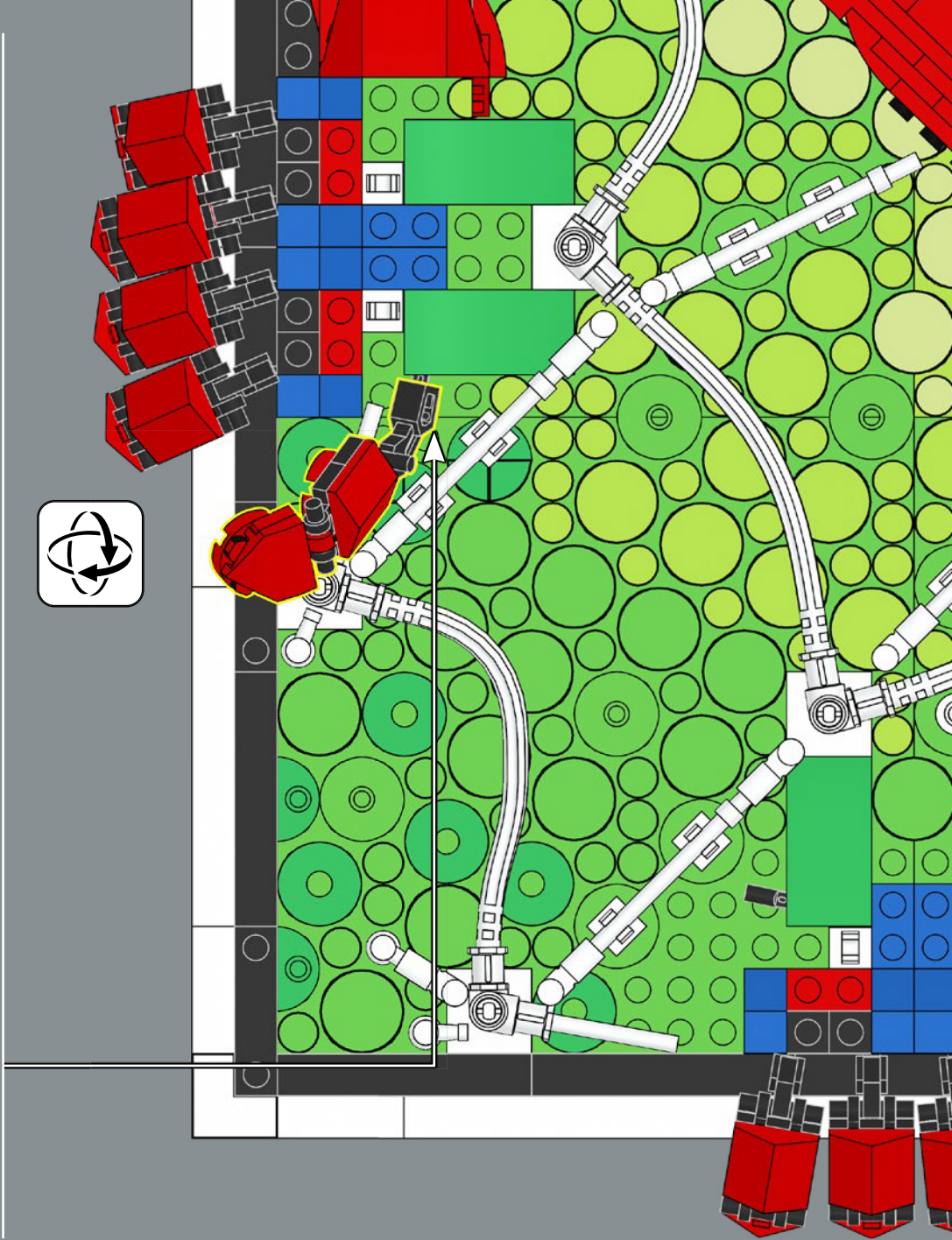
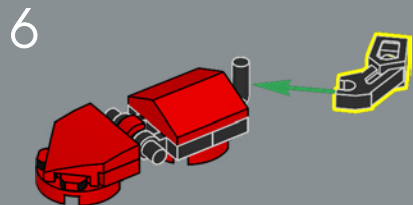
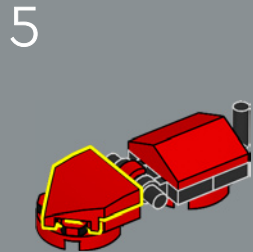
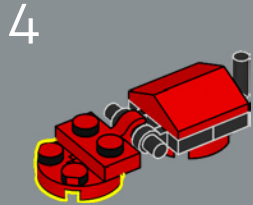
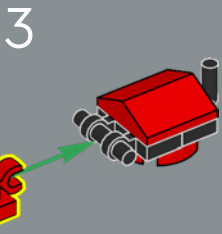
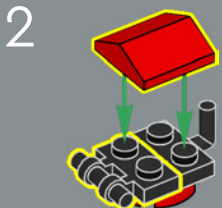
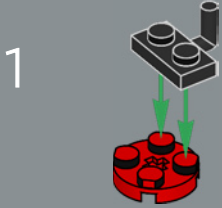

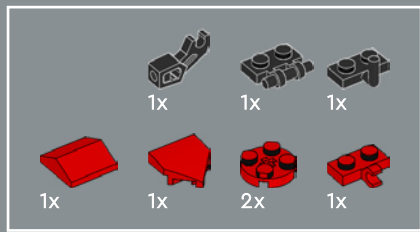

305

1

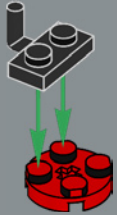

2

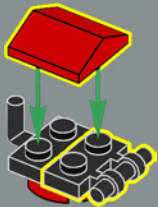

3

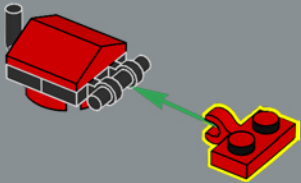

4

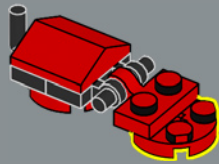

5

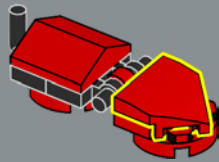

6

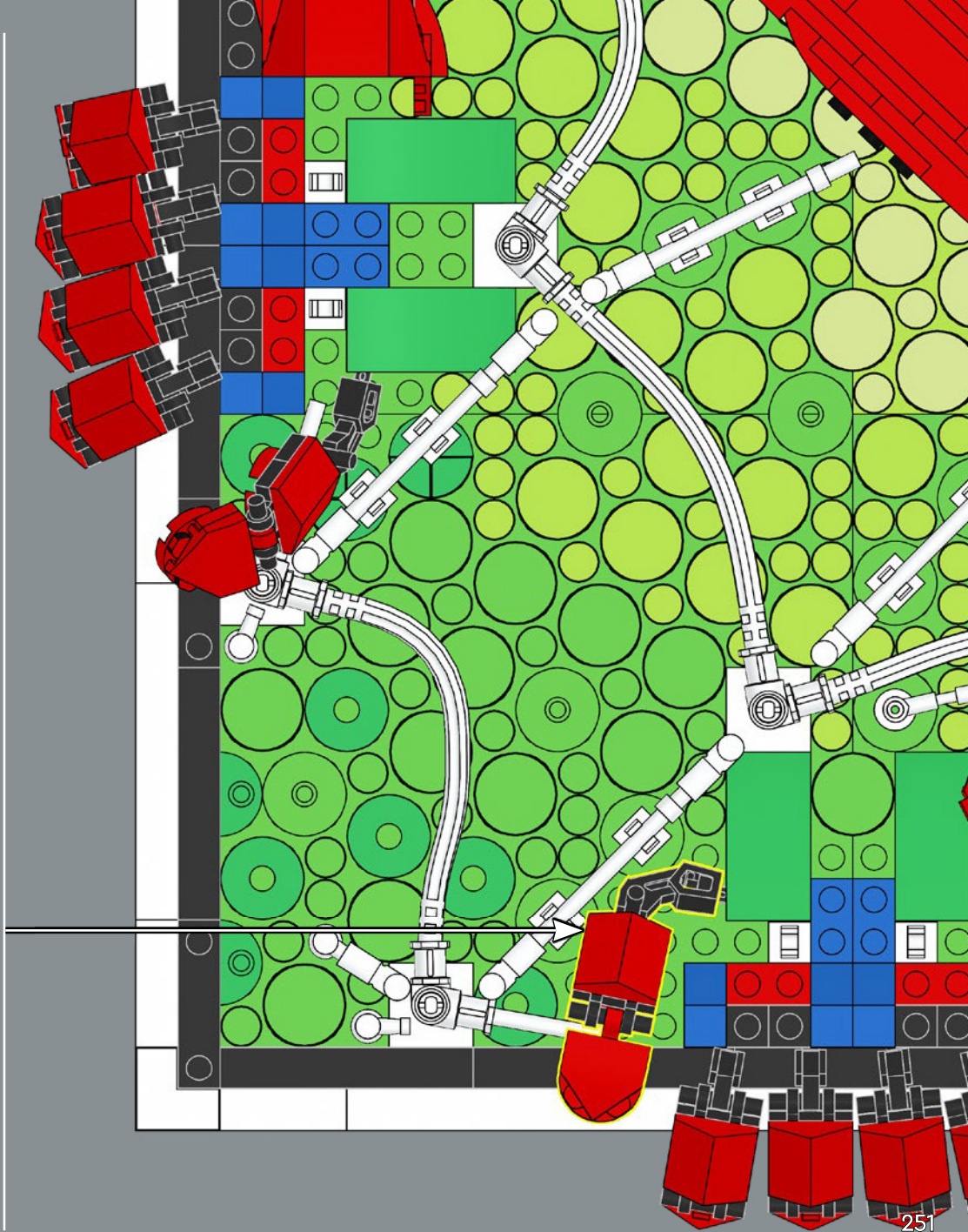
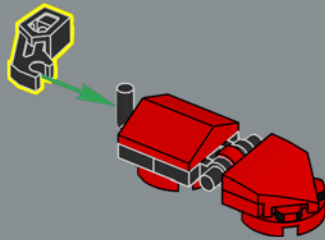

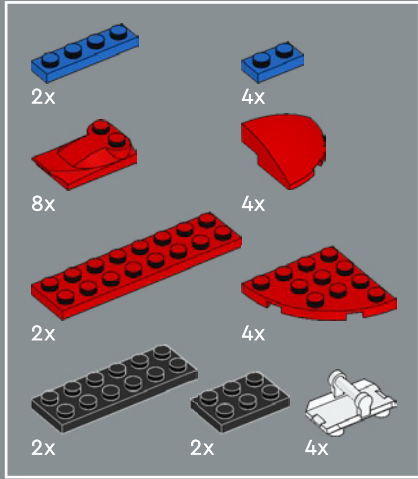
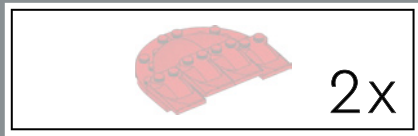

306

1

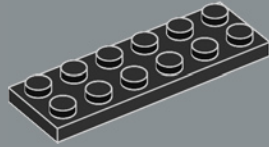

2

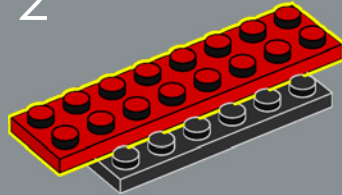

3

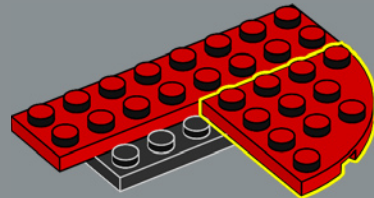

4

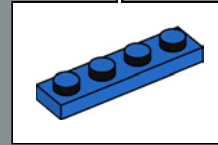
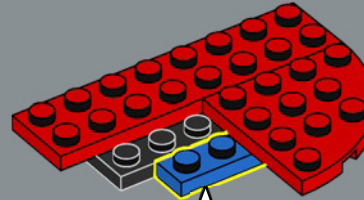

5

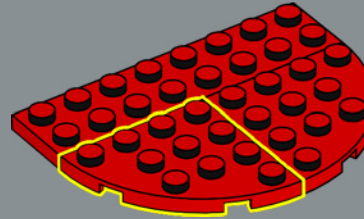

6

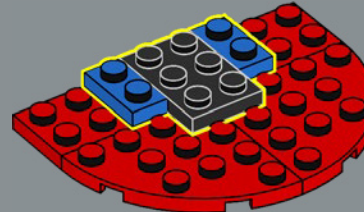

7

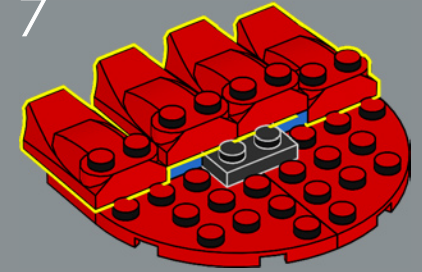

8

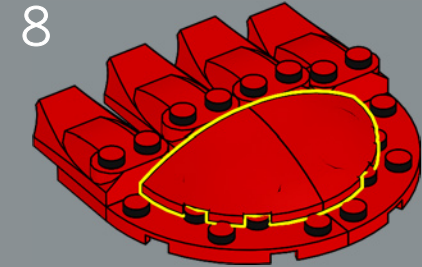

9

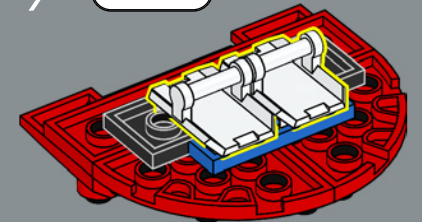

2x

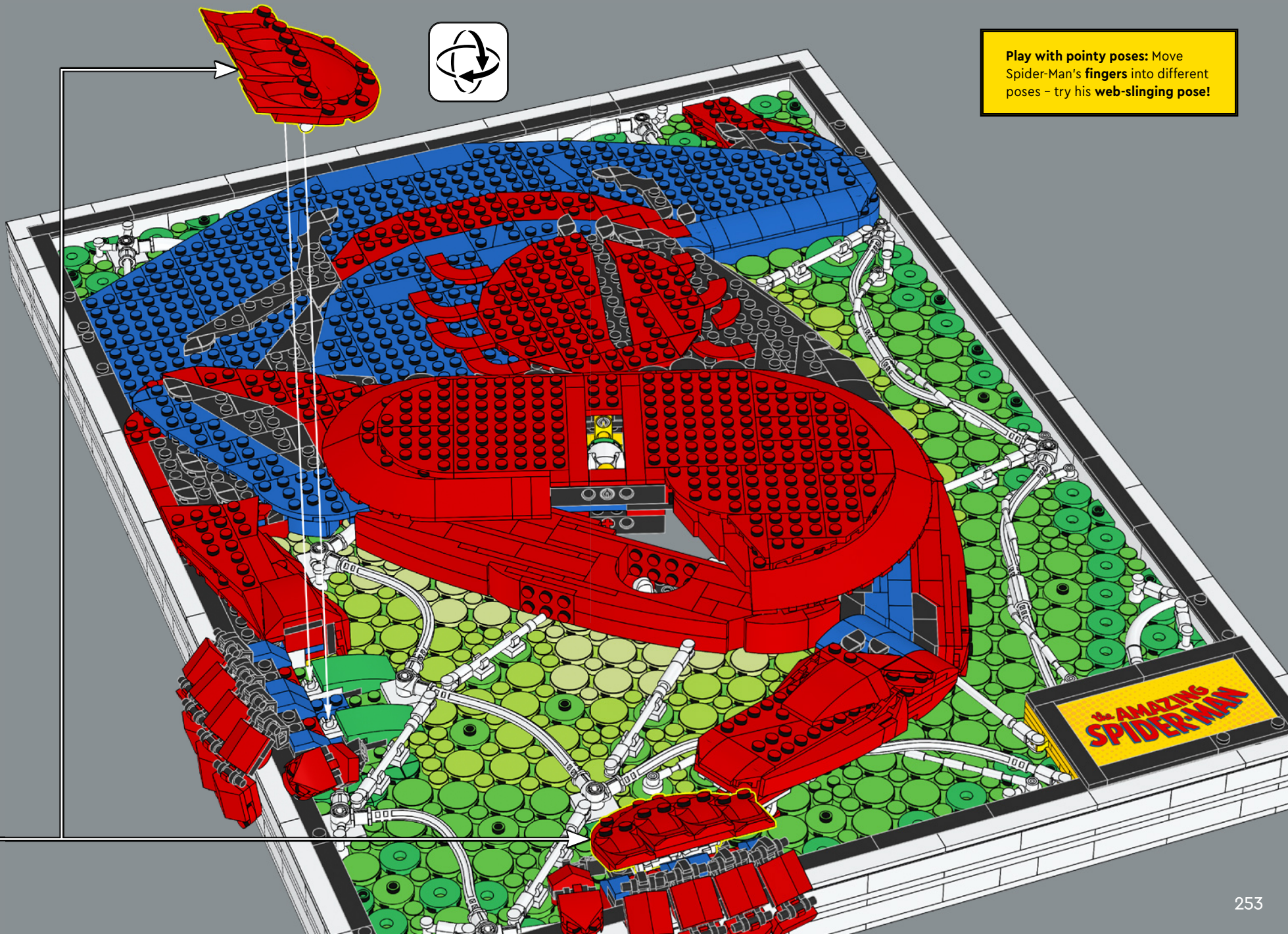

Play with pointy poses: Move Spider-Man's fingers into different poses – try his web-slinging pose!

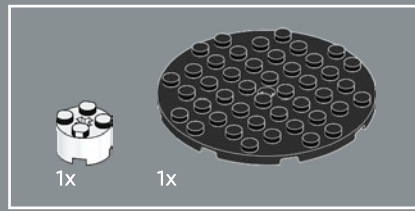
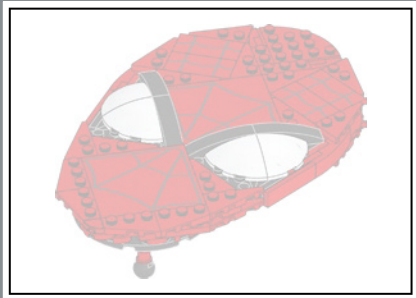

307

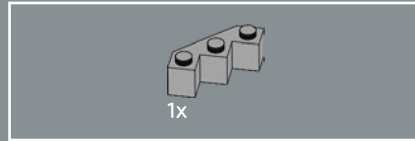

308

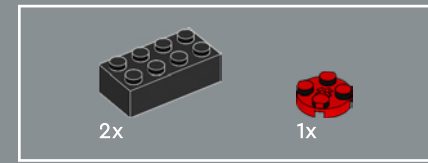
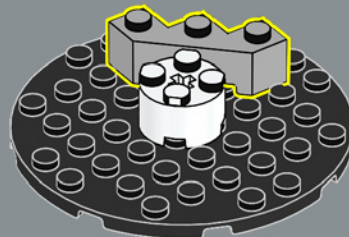

309

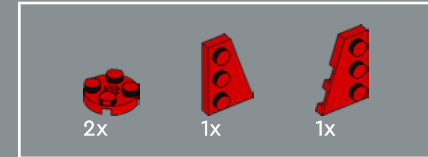
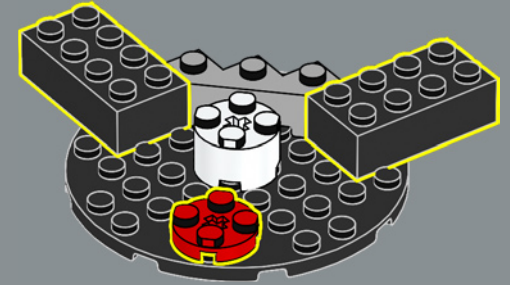

310

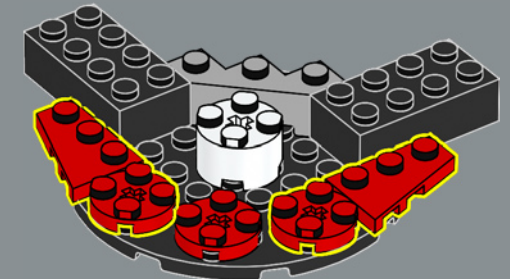

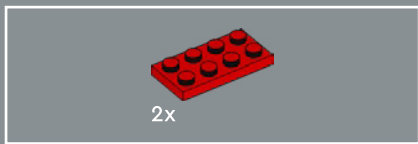

311

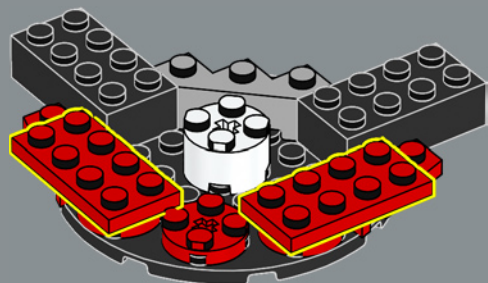

312

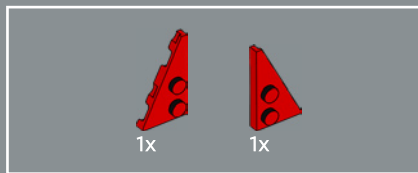
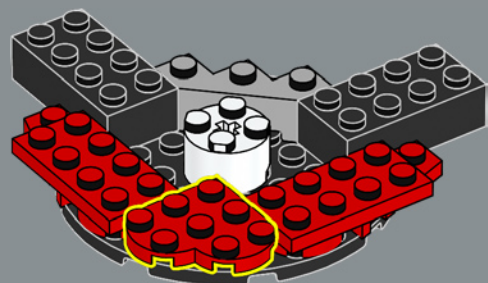

313

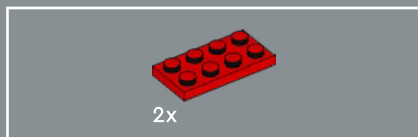
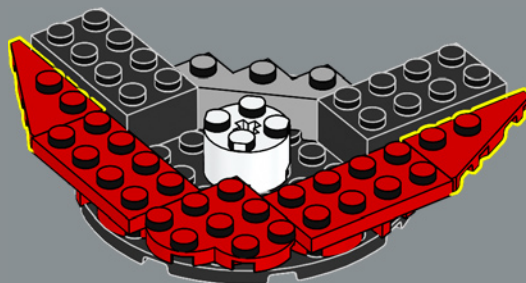

314

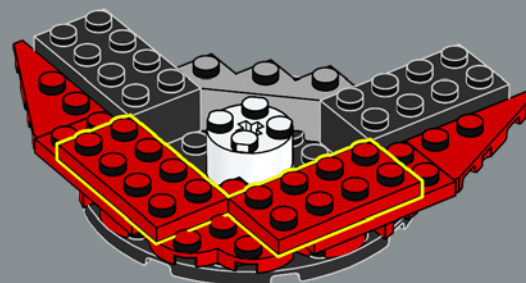

315

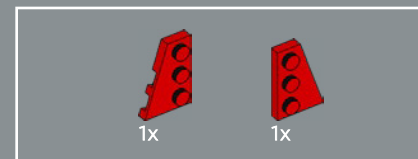
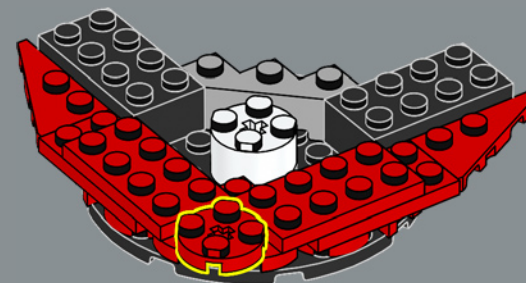

316

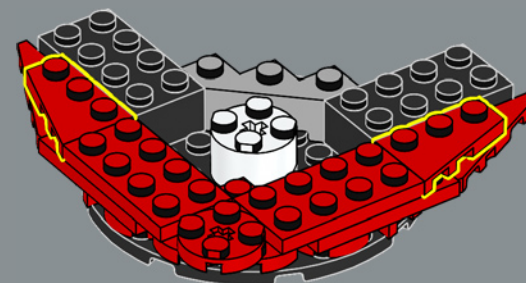

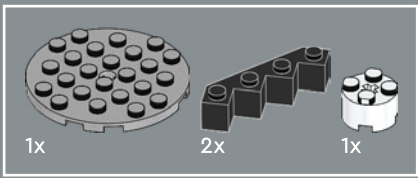

317

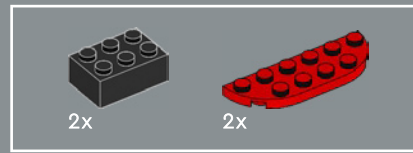
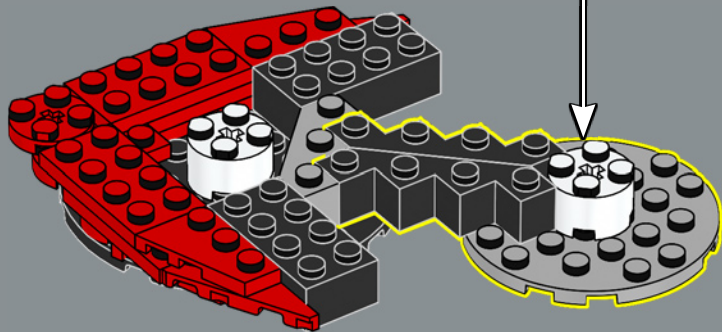
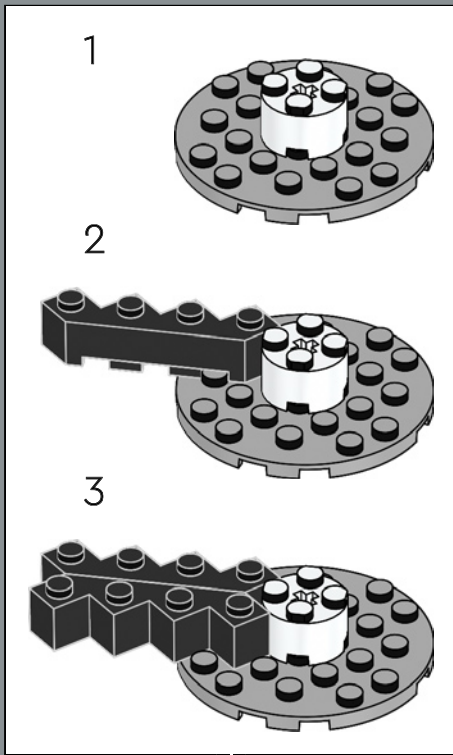

318

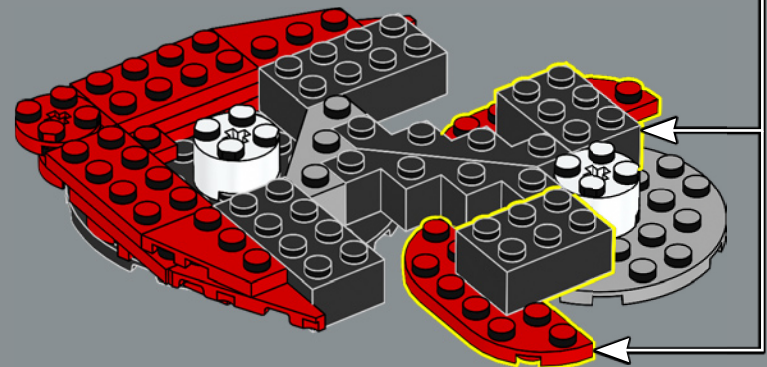
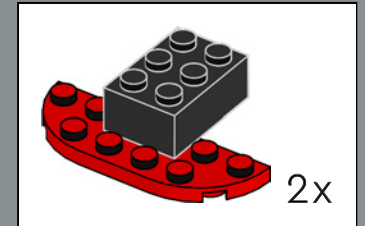

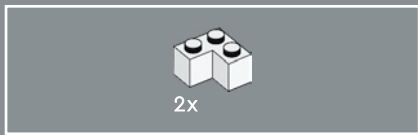

319

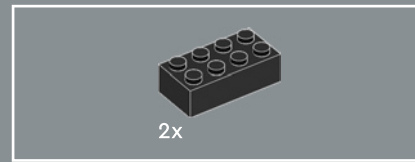
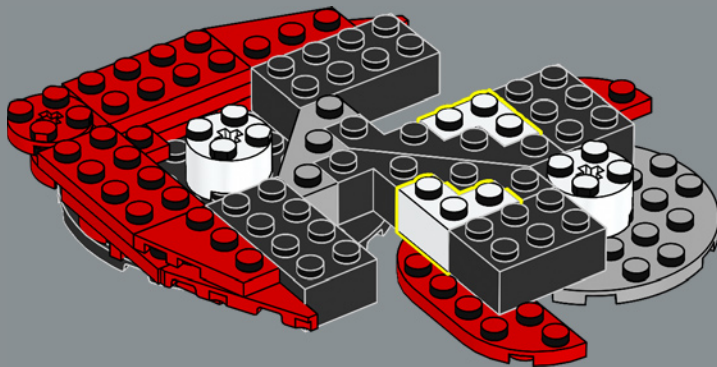

320

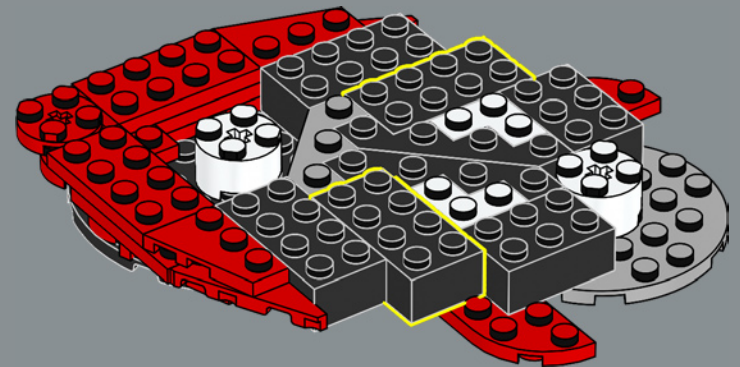



321

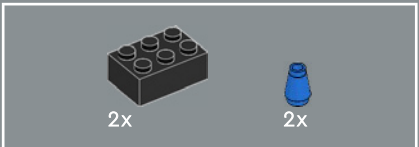
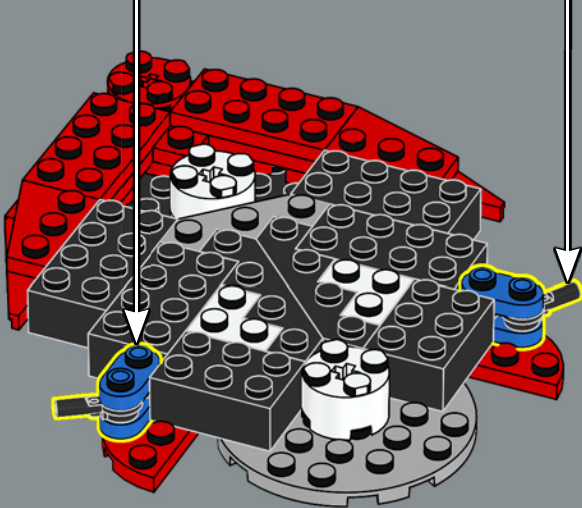
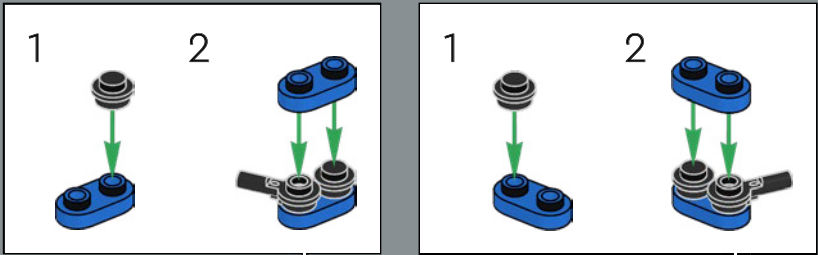

322

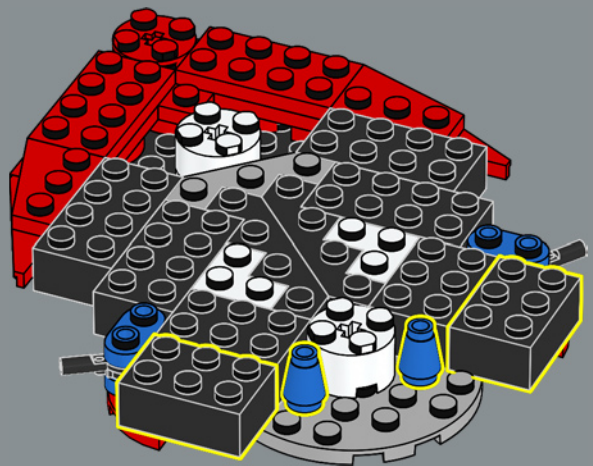

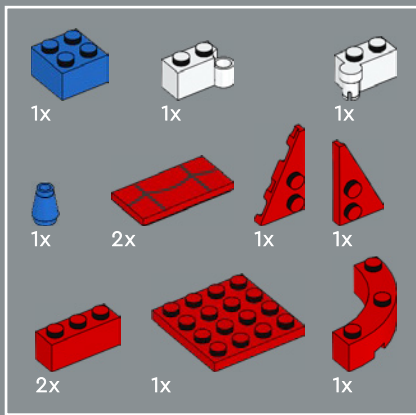

323

1

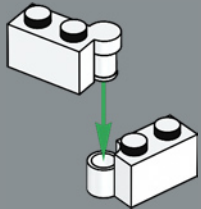

2

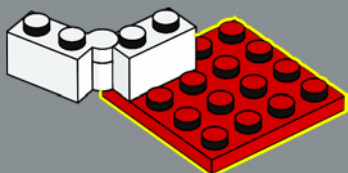

3

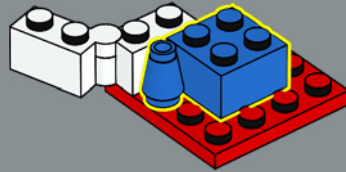

4

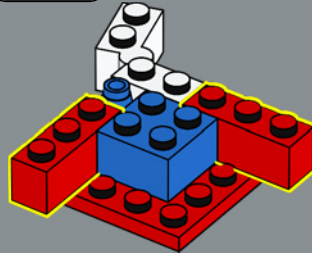

5

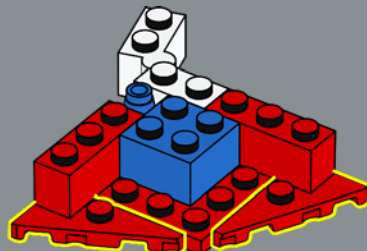

6

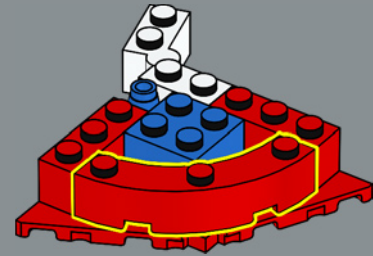

7

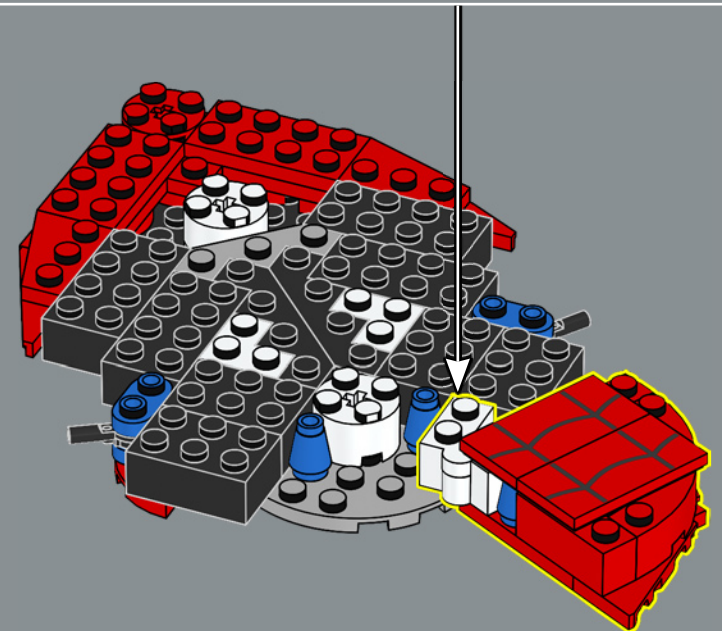
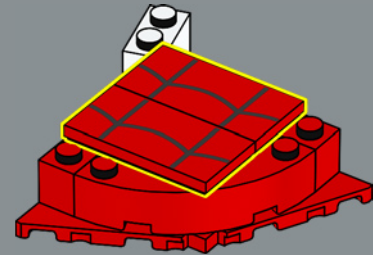

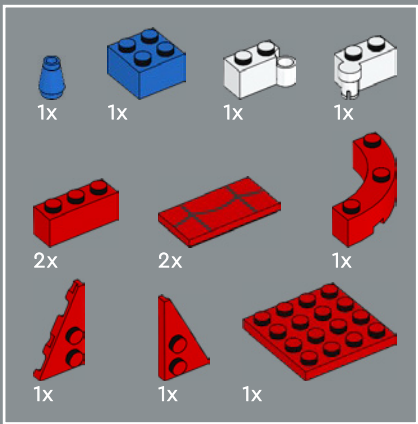

324

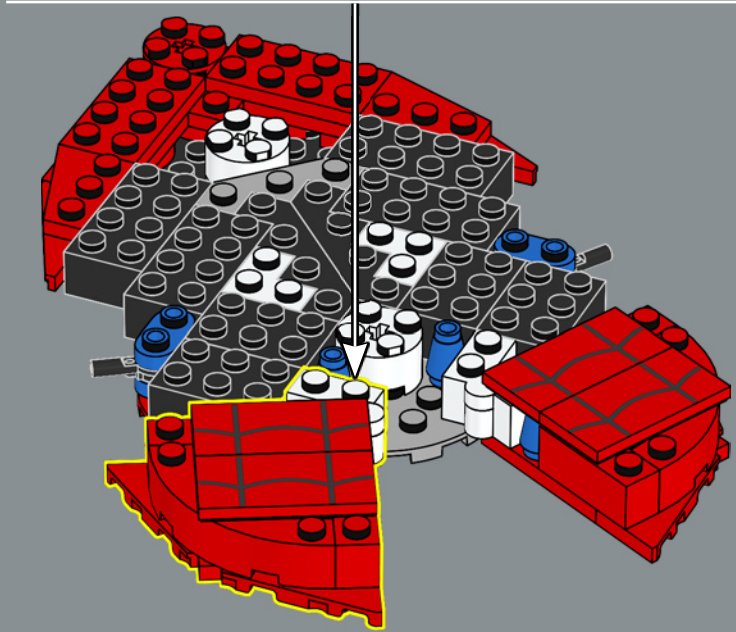
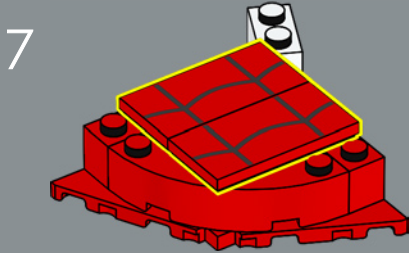
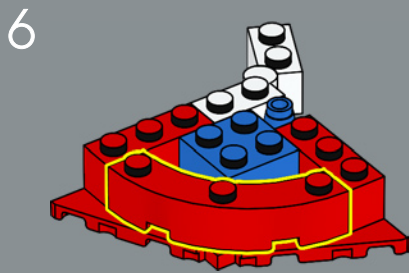
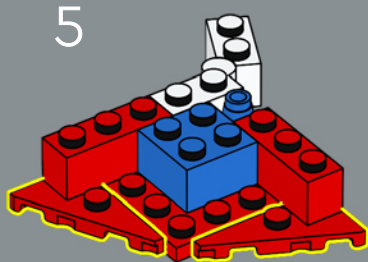
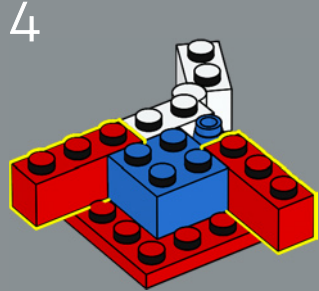
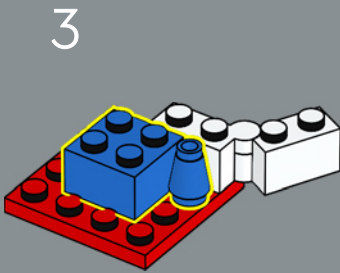
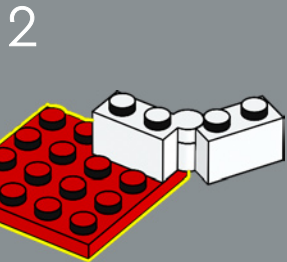
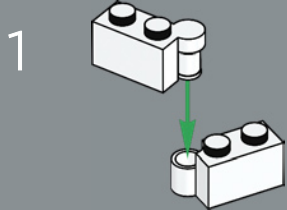

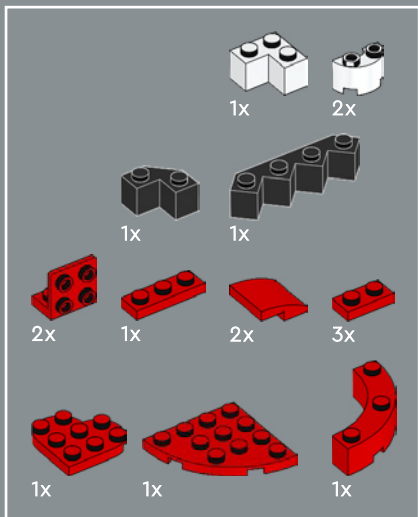

325

1



2

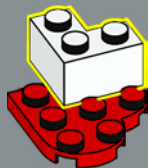

3

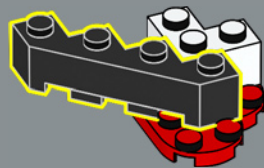

4

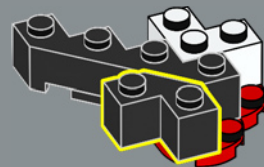

5



1

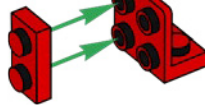

2

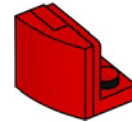

6

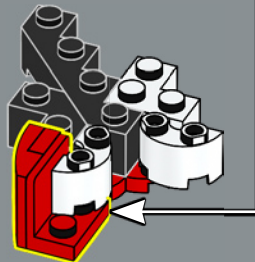

1

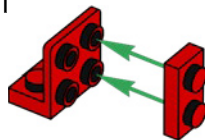

2

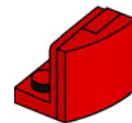

7

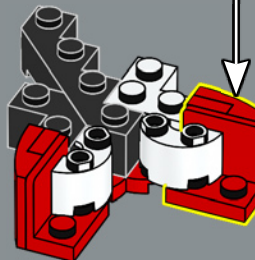

8

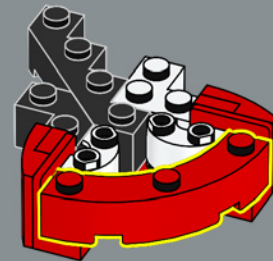

9

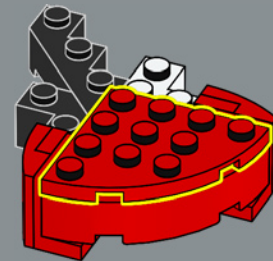

10

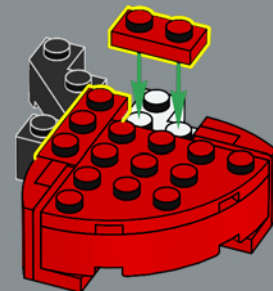

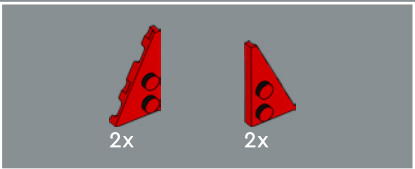

326

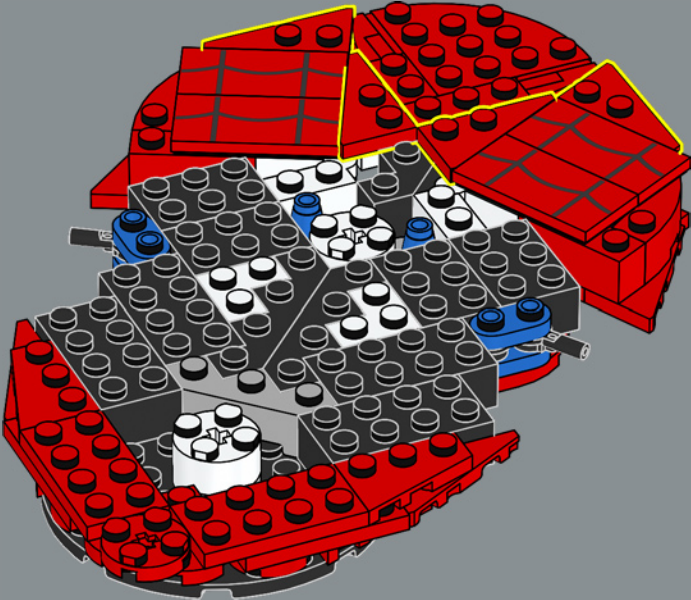
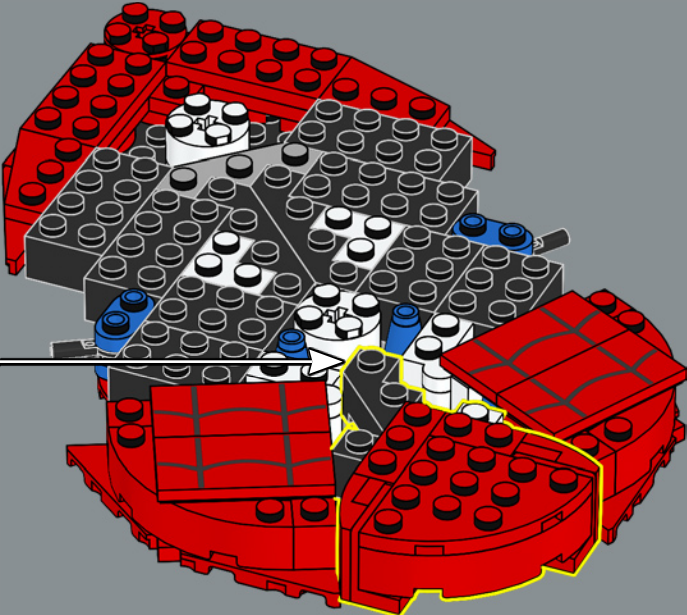

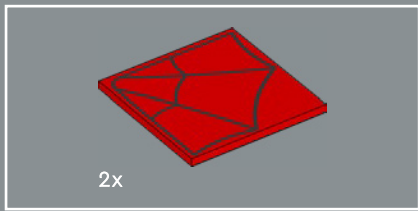

327

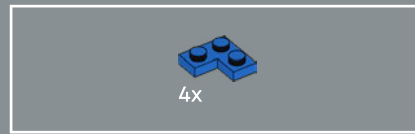
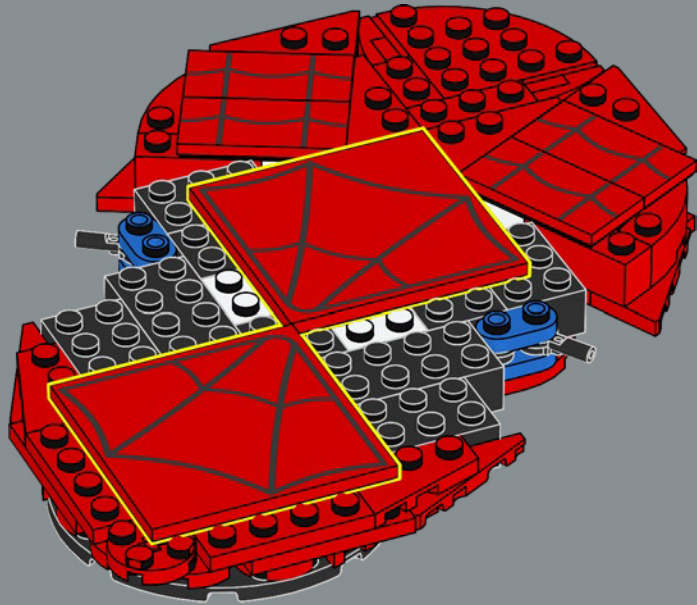

328

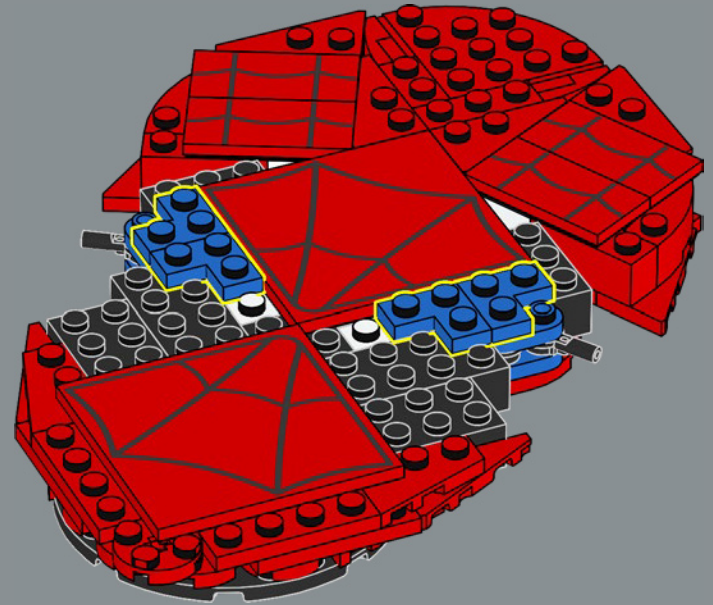

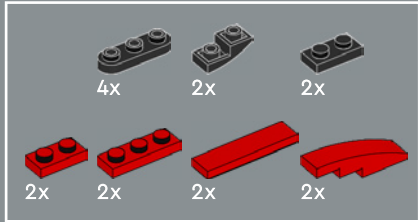
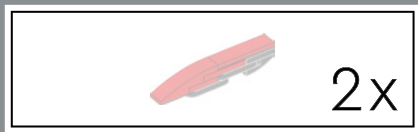

329

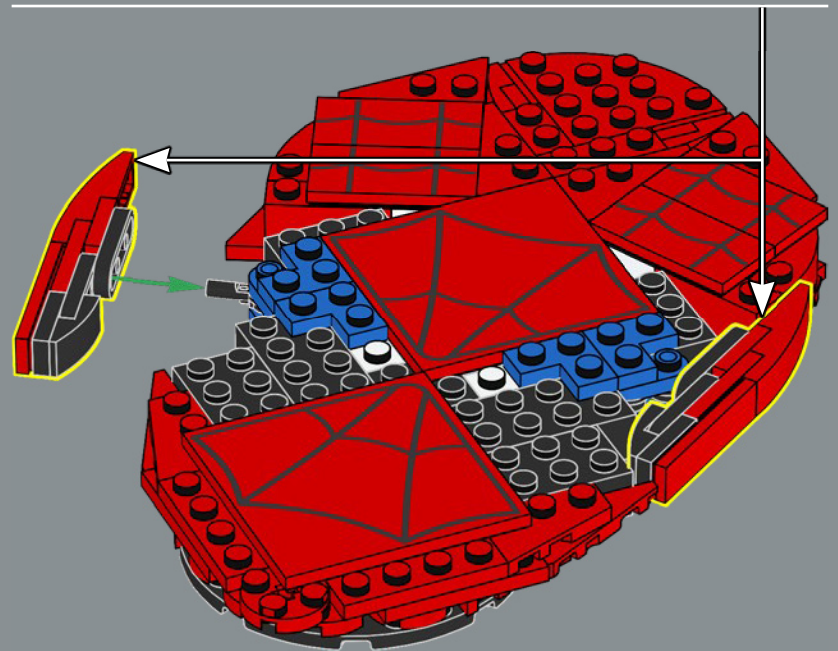
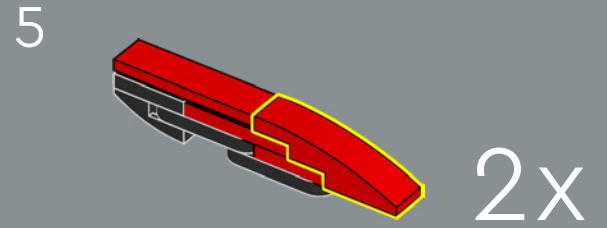
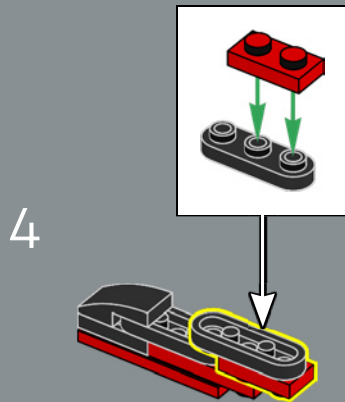
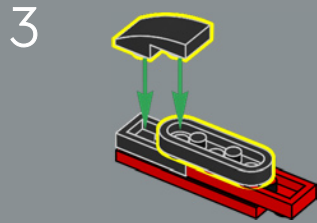
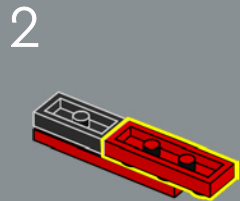
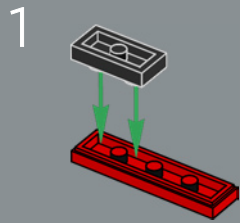



330

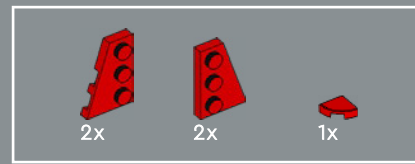
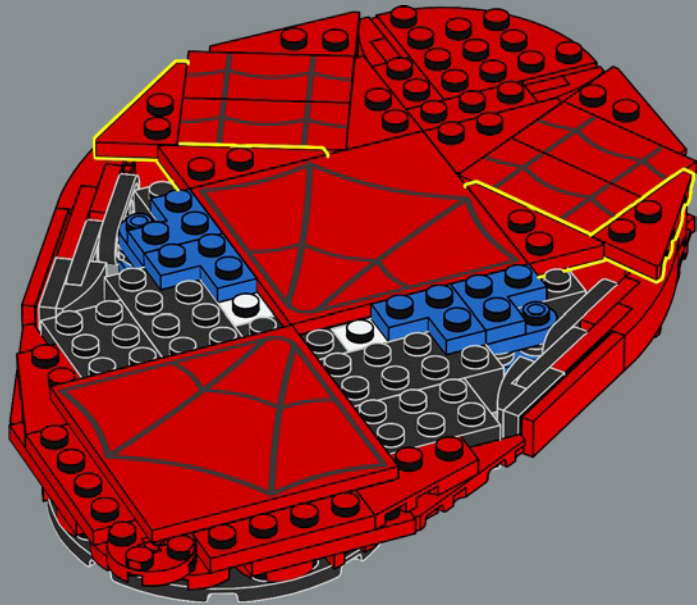

331

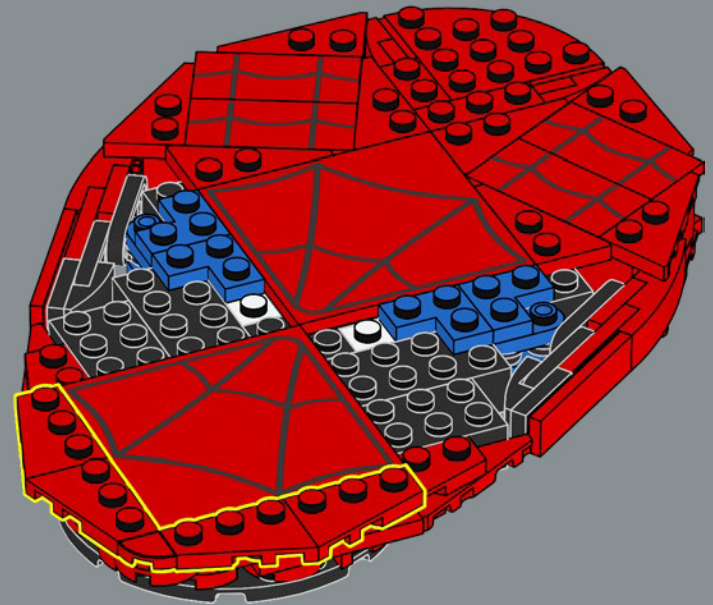

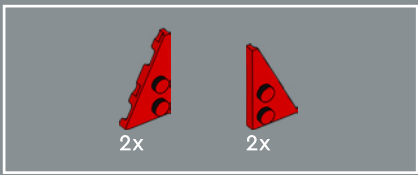

332

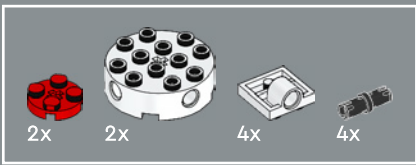
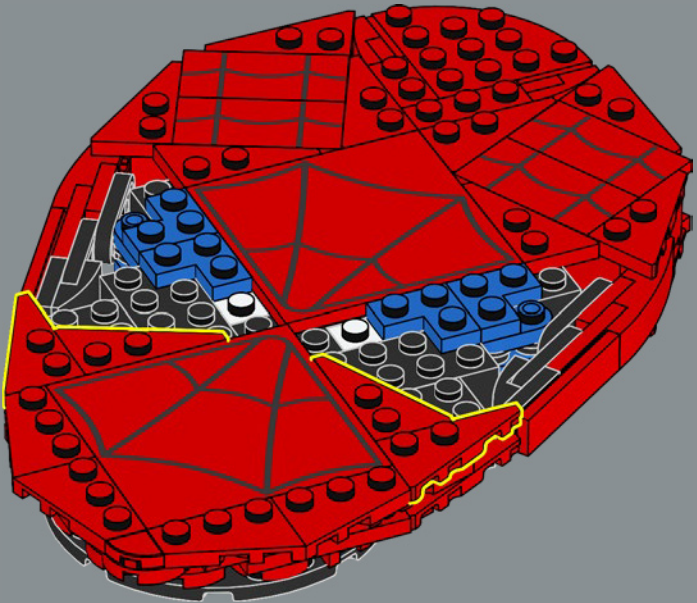

333

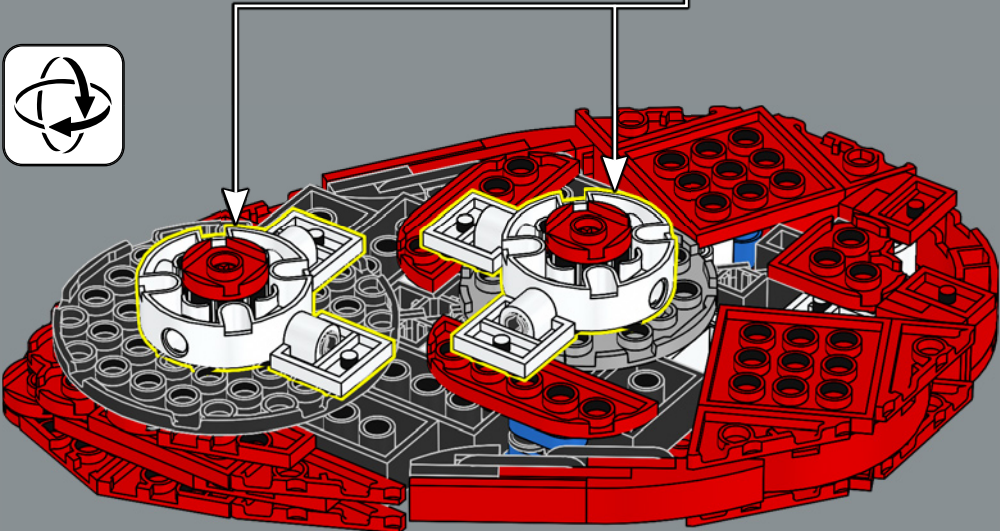
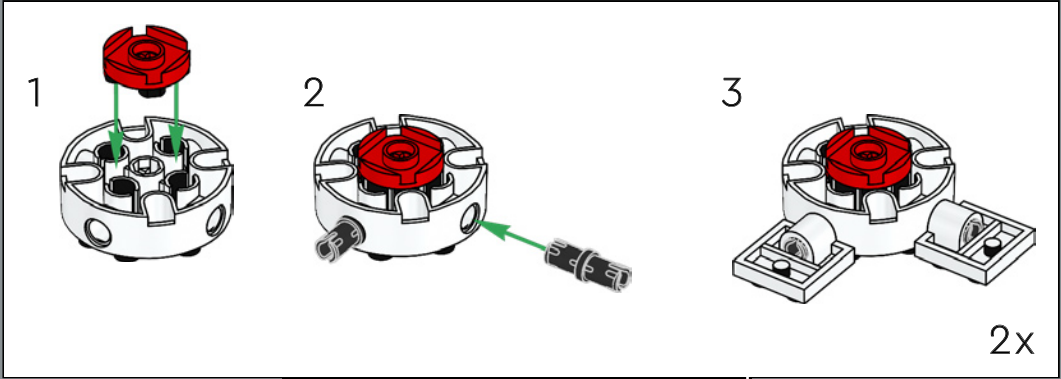

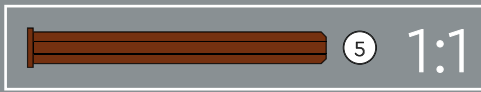
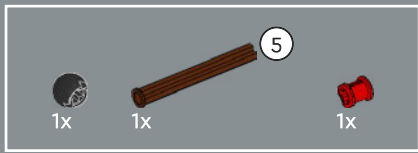

334

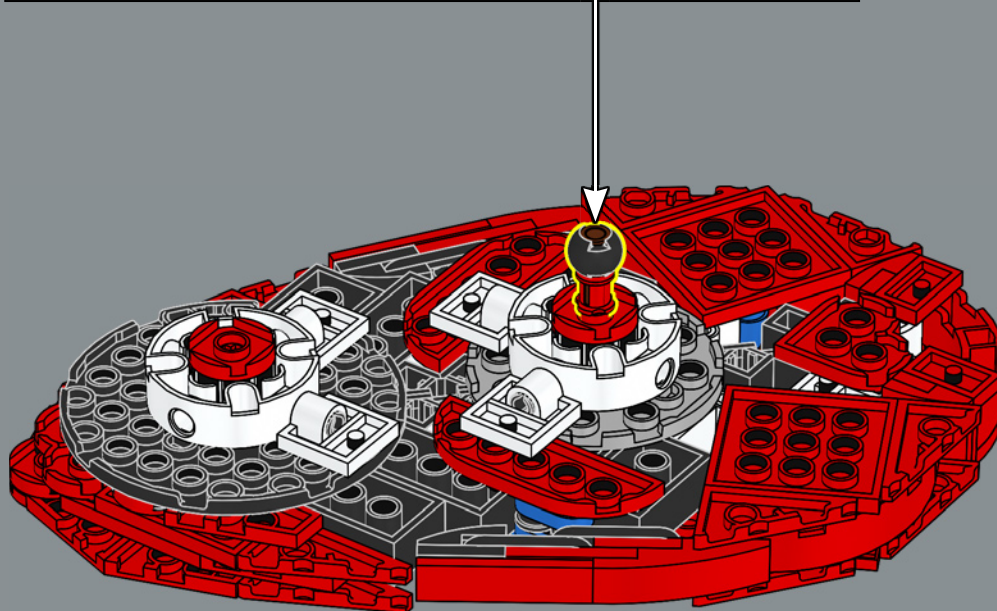
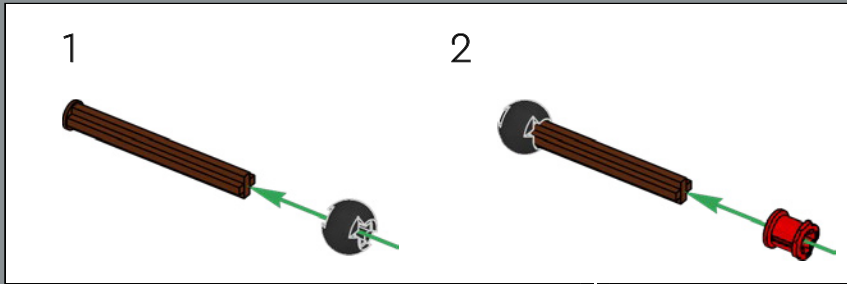

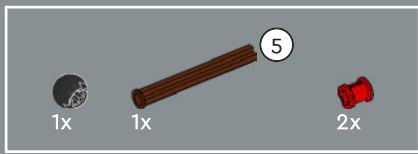

335



336

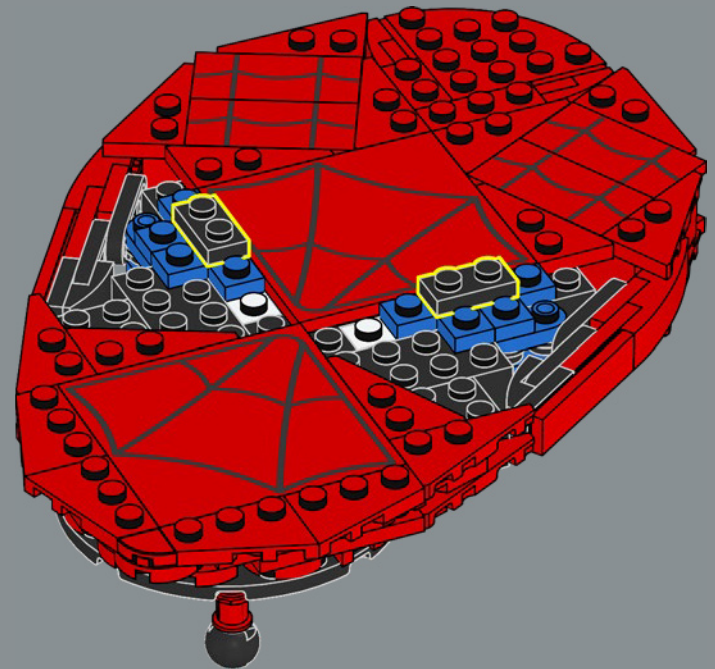
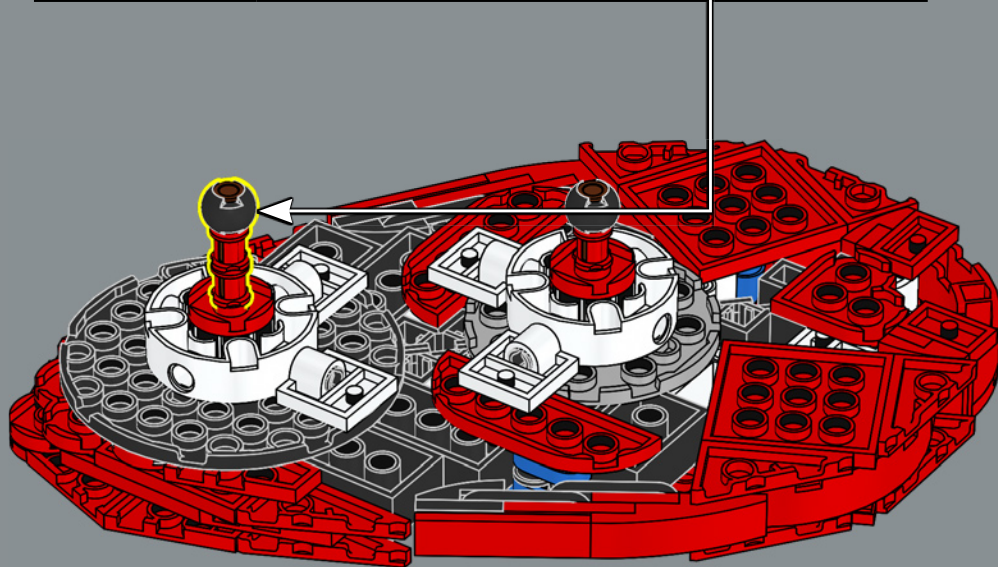
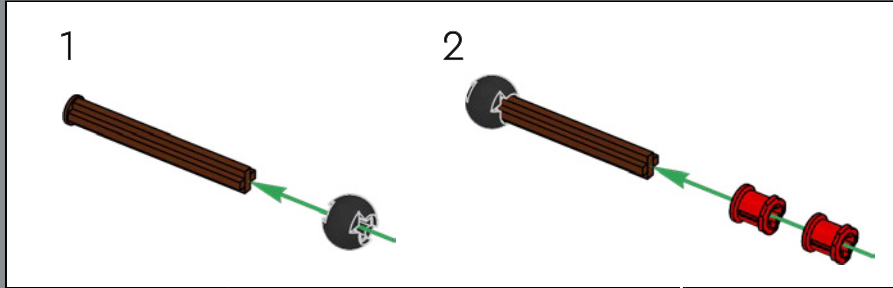



337

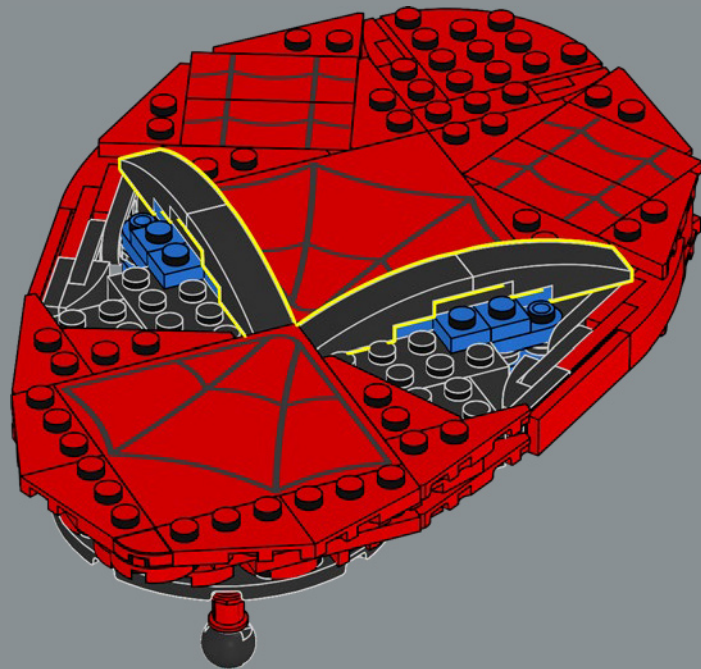

338

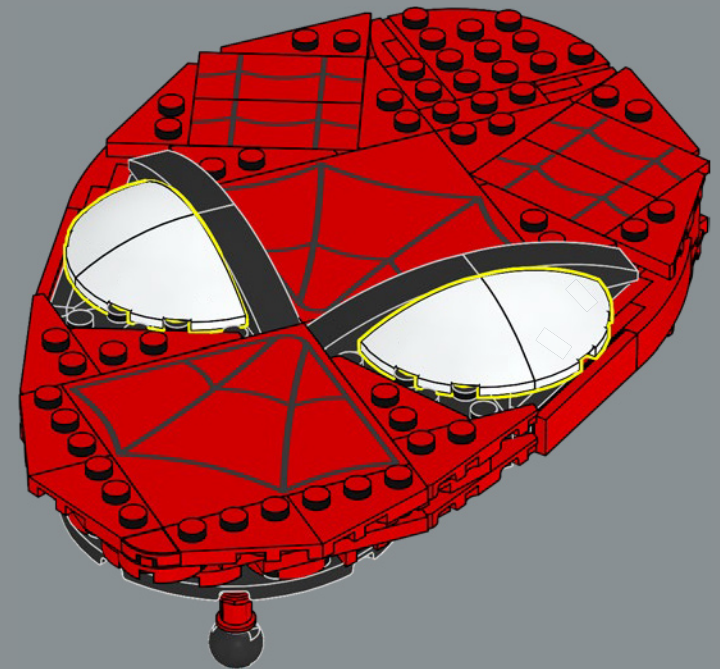

Turn Spider-Man's head **from side to side** - watch how his face **changes expressions!** The **sphere elements** create an **optical illusion** when you see the face from different angles!

339

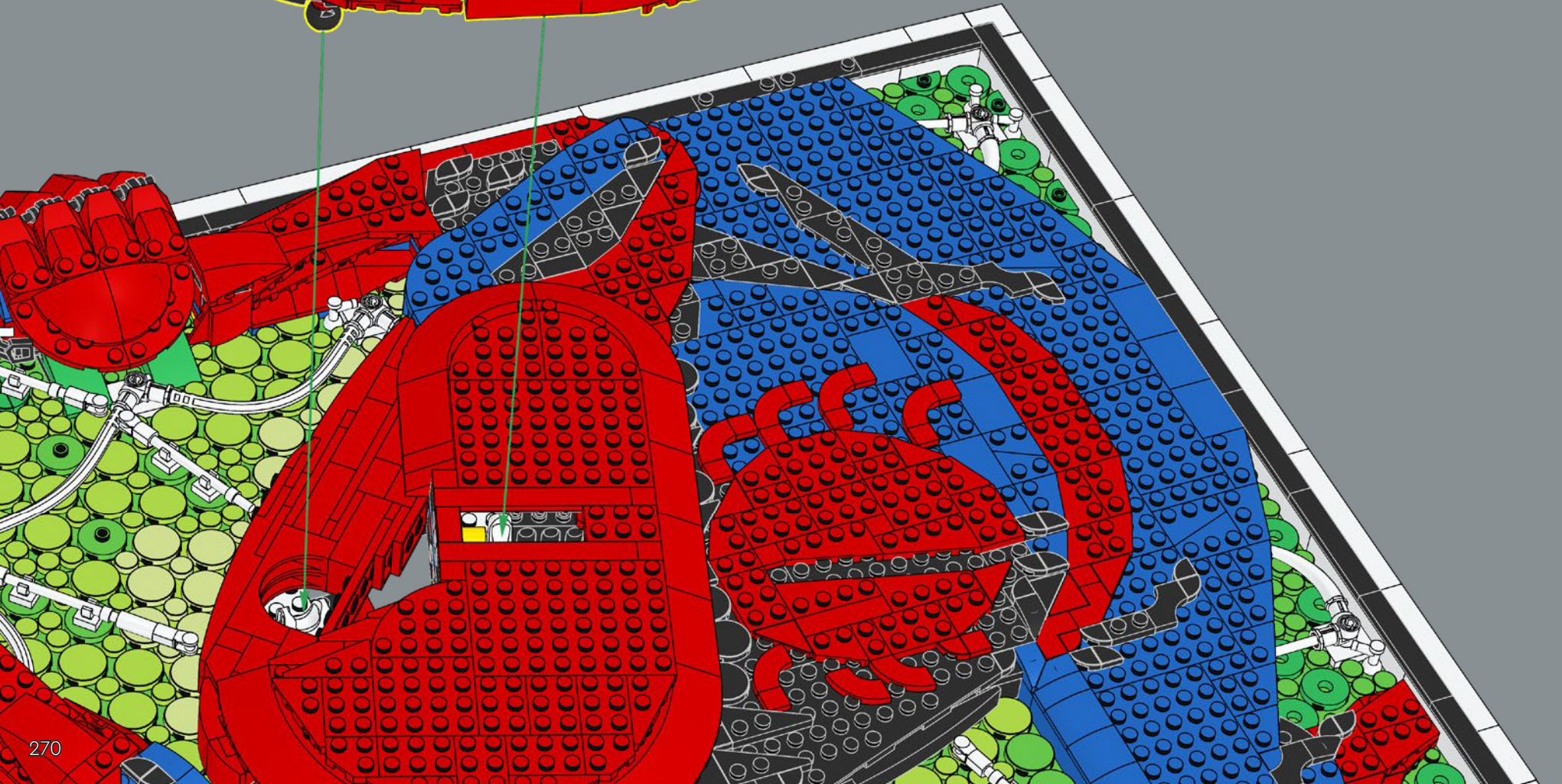
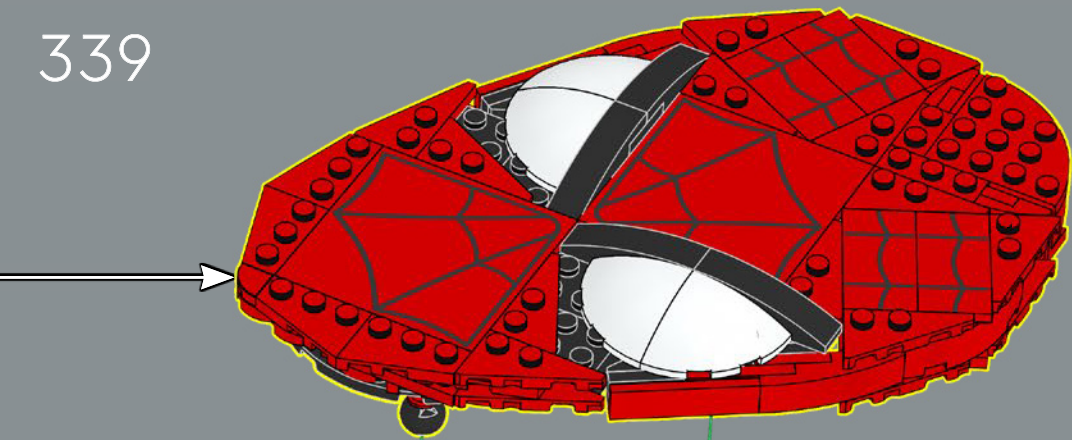



15x

340

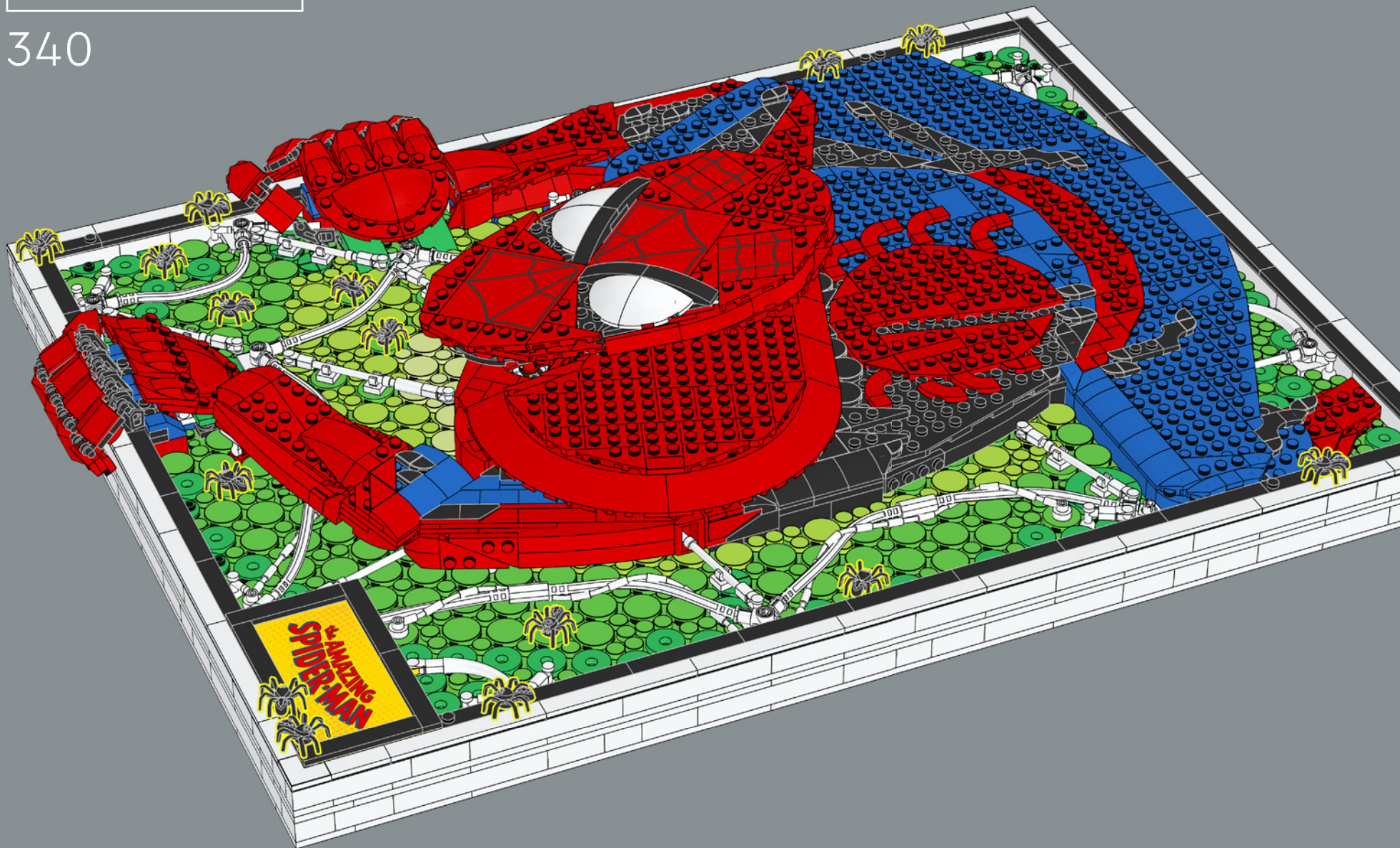

Notice the **15 spiders** in the frame?
The number is an homage to the
first appearance of Spider-Man in
AMAZING FANTASY (1962) #15. Also,
Peter Parker was **15 years old** when
he gained his **powers**!



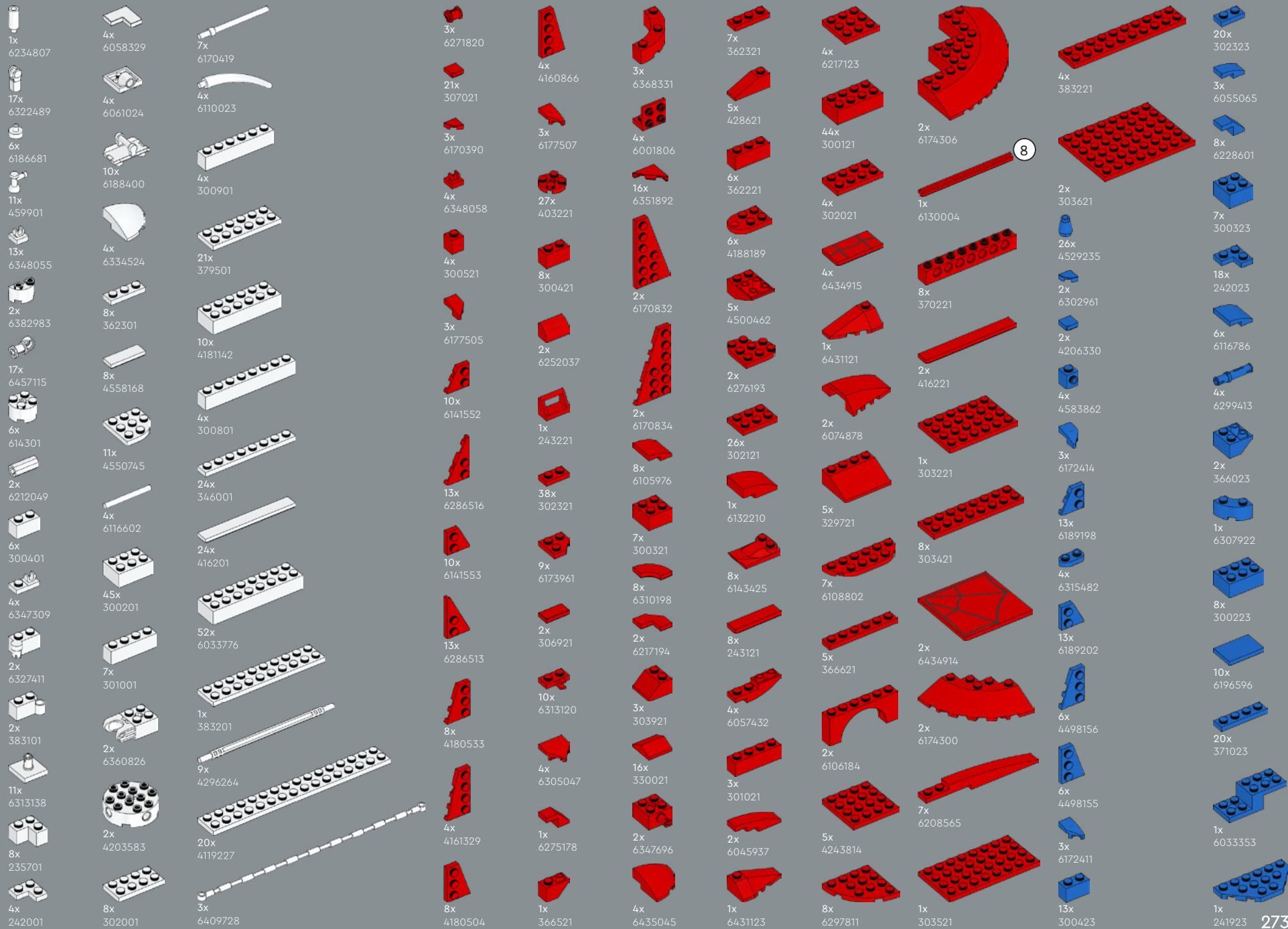

- 2x 6146306
- 5x 303223
- 3x 303423
- 7x 6037384
- 8x 303623
- 10x 4611777
- 6x 6150607
- 19x 6424859
- 42x 6074954
- 4x 6365611
- 4x 6285601
- 154x 6353793
- 71x 6422433
- 24x 6380676
- 13x 614126
- 1x 6186698
- 2x 4286267
- 31x 6172383
- 3x 6181720
- 4x 6433936
- 5x 6141554
- 3x 6295295
- 5x 6141556
- 3x 6295293
- 3x 6181713
- 9x 306926
- 9x 302326
- 2x 370026
- 10x 6261348
- 2x 6147050
- 1x 4121966
- 1x 6250020
- 14x 6214807
- 15x 6234806
- 18x 4140588
- 9x 6428168
- 1x 4283047
- 1x 4283046
- 15x 302226
- 5x 6196548
- 10x 300226
- 1x 329826
- 7x 302126
- 7x 6254045
- 1x 371026
- 2x 6039869
- 4x 6037746
- 12x 300126
- 1x 4188534
- 3x 6039347
- 1x 370626
- 33x 663626
- 6x 6070695
- 10x 6276867
- 16x 379526
- 2x 6401209
- 1x 6131571
- 5x 346026
- 2x 6456527
- 1x 6393938
- 1x 6037664
- 5x 4617860
- 4x 303626
- 14x 6279875
- 3x 6053077
- 3x 6425507
- 1x 4584274
- 1x 389426
- 2x 6101857
- 2x 6302094
- 2x 6448394
- 1x 303026
- 1x 6394881
- 1x 4143180
- 13x 428226
- 5x 6348065
- 15x 302324
- 6x 370024
- 2x 6247387
- 2x 6072627
- 1x 4558172
- 8x 371024
- 1x 301024
- 8x 4515349
- 2x 6310219
- 1x 6434916
- 27x 6284598
- 22x 6424480
- 2x 6159763
- 100x 6284583
- 42x 6092766
- 2x 6424330
- 1x 6240515
- 1x 6375710
- 2x 4494475
- 1x 6326478
- 1x 4211718
- 1x 6015349
- 4662161

5

6



LEGO.com/service



YOU COULD WIN



YOU COULD WIN

Your feedback will help shape the future development of this product series.

Visit:

DU KÖNNTEST GEWINNEN

Dein Feedback trägt zur Weiterentwicklung dieser Produktreihe bei.

Geh auf:

VOUS POURRIEZ GAGNER

Vos commentaires nous aideront à concevoir les futurs produits de cette gamme.

Visitez :

POTRESTI VINCERE TU

La tua opinione ci aiuterà a migliorare la creazione futura di questa linea di prodotti.

Visita:

PUEDES GANAR

Tu opinión contribuirá al futuro de esta serie de productos.

Visita:

轻松获奖

您的反馈将有助于我们在今后改进本产品系列。

请访问:

[LEGO.com/productfeedback](https://www.lego.com/productfeedback)

You also have the chance to win a LEGO® set.

Terms and conditions apply.*

Außerdem hast du die Chance, ein LEGO® Set zu gewinnen.

Es gelten die Teilnahmebedingungen.*

Vous pourriez également gagner un ensemble LEGO®.

Des conditions s'appliquent.*

Hai anche la possibilità di vincere un set LEGO®.

Termini e condizioni sono applicabili.*

También tienes la oportunidad de ganar un set LEGO®.

Aplican términos y condiciones.*

您还有机会赢取乐高®套装。

条款和条件适用。*

*[LEGO.com/productfeedback-terms](https://www.lego.com/productfeedback-terms)

the AMAZING
SPIDER-MAN

LEGO and the LEGO logo are trademarks of the LEGO Group.

©2023 The LEGO Group. 6504256

© 2023 MARVEL