

Trend Line 600 FHTL 604 4G XS E Inox satinato |

106.0183.101

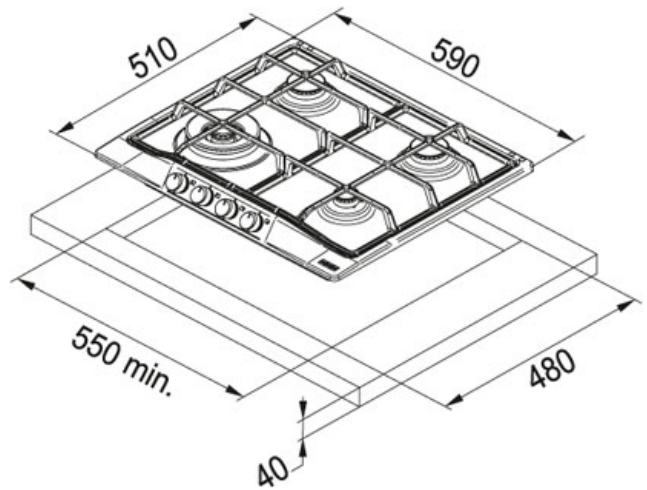





FAMIGLIA : Piani Cottura | SERIE : Trend Line 600 | MODELLO : FHTL 604 4G XS E | FINITURA : Inox satinato |
INSTALLAZIONE : Incasso



DATI TECNICI

Numero Fuochi	4
Potenza (W)	Ausiliario 1000W Semirapido 1750W Rapido 3000W
Griglie in dotazione	Griglie smaltate
Dimensioni	590x510
Foro Incasso	550x480

FUNZIONI

	Accensione elettronica integrata		Griglie in ghisa optional
	Kit manopole optional		Valvola di sicurezza
	AISI 304		Nuovo