

# GHOSTBUSTERS™ ECTO-1

BUILDING INSTRUCTIONS  
INSTRUCTIONS DE MONTAGE  
INSTRUCCIONES DE CONSTRUCCIÓN

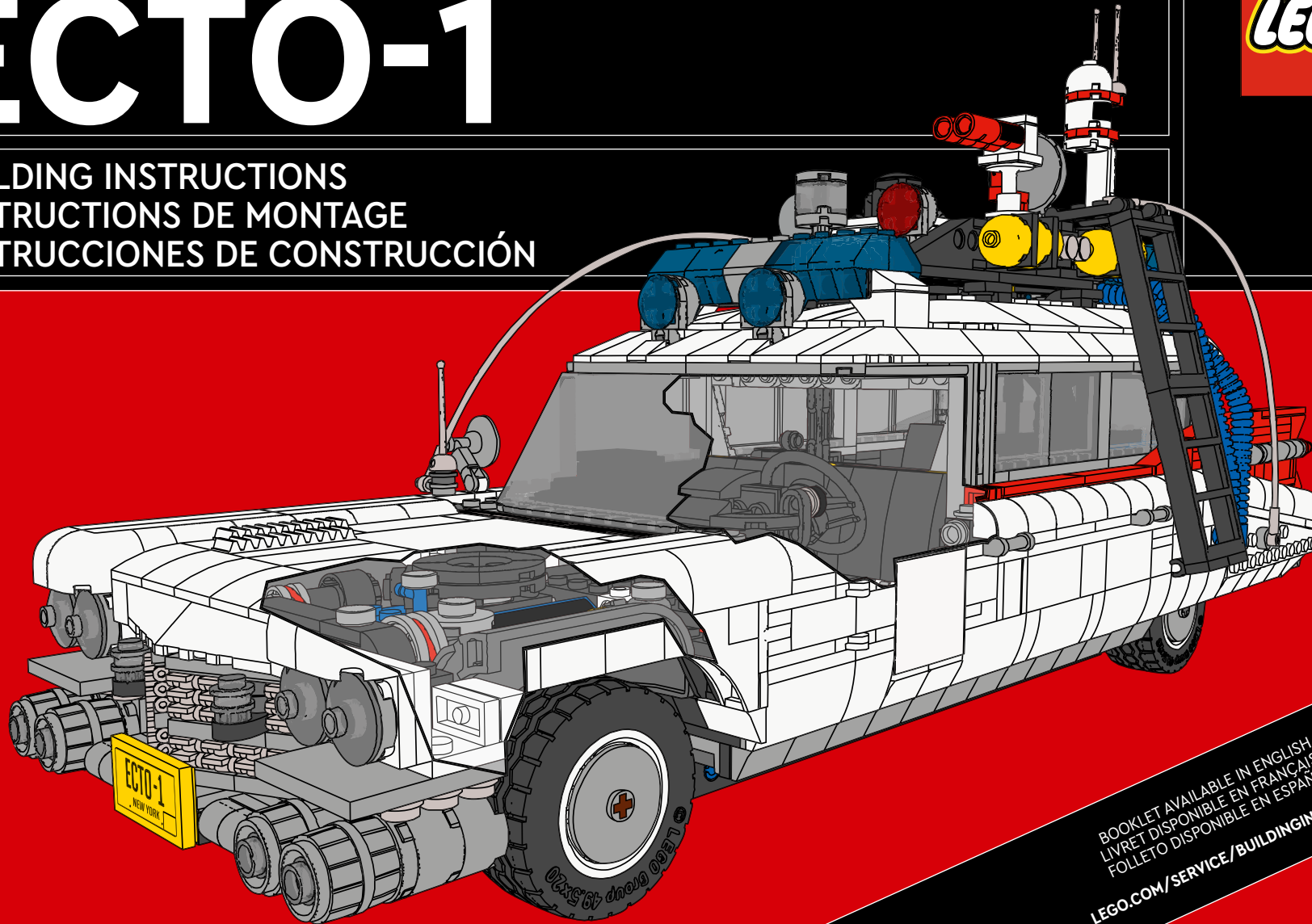

BOOKLET AVAILABLE IN ENGLISH ON  
LIVRET DISPONIBLE EN FRANÇAIS SUR  
FOLLETO DISPONIBLE EN ESPAÑOL EN  
[LEGO.COM/SERVICE/BUILDINGINSTRUCTIONS](http://LEGO.COM/SERVICE/BUILDINGINSTRUCTIONS)

## CLASSIFIEDS | PETITES ANNONCES | CLASIFICADOS

### HELP WANTED

**WE'RE CALLING YOU!**

There are ghosts appearing all over Summerville and we need your help right away! This is an exciting opportunity to re-build the legendary Ecto-1 with some brand-new upgrades according to the plans we uncovered in a barn not far from town. The car is literally

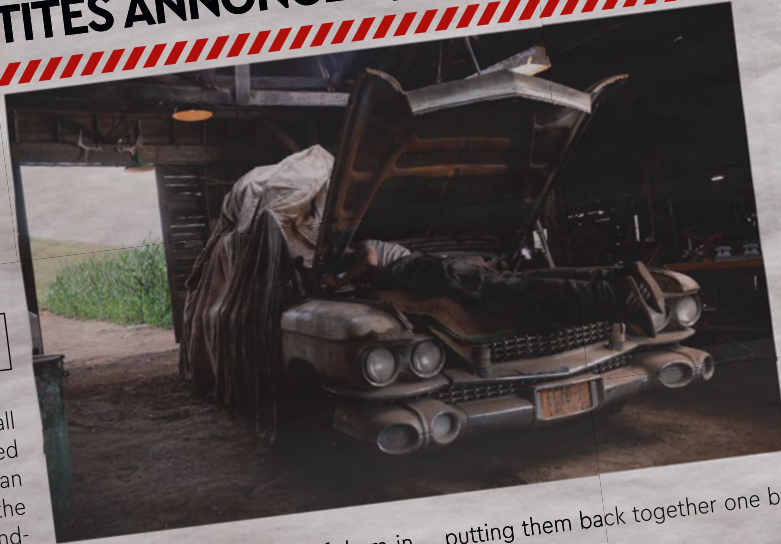

in pieces though, 2,352 of them in fact, and you'll have the honor of putting them back together one by one.

### NOUS EMBAUCHONS

**ON A BESOIN DE VOUS !**

Des fantômes se manifestent aux quatre coins de Summerville et nous avons besoin d'aide immédiatement ! Il s'agit d'une formidable occasion de reconstruire la légendaire Ecto-1 tout en y apportant

quelques améliorations selon les plans que nous avons trouvés dans une grange loin de la ville. La voiture est littéralement en morceaux, 2 352 pour être exact, et vous aurez l'honneur de les réassembler un par un.

### SE NECESITA PERSONAL

**¡TE LLAMAMOS A TI!**

¡Toda Summerville se está llenando de fantasmas y necesitamos tu ayuda inmediato! Tienes ante ti una emocionante oportunidad de reconstruir el legendario Ecto-1 con las nuevas funciones que descubrimos en unos planos ocultos en un granero no muy lejos de la ciudad. El auto está, literalmente, deshecho, y ahora disfrutarás del honor de rearmarlo pieza por pieza (preparate, ¡porque son 2352!).

The Ghostbusters have a long history protecting residents from the paranormal. They saved New York from the Stay Puft Marshmallow Man and protected the world from the evil spirit of Gozer. When slime levels rise, and ghosts descend, you know who to call!

Les chasseurs de fantômes protègent les citoyens contre les phénomènes paranormaux depuis longtemps. Ils ont sauvé New York de Bibendum Chamallow et protégé le monde de l'esprit maléfique de Gozer. Quand les niveaux d'ectoplasme montent et que les fantômes apparaissent, vous savez qui appeler !

Los cazafantasmas acumulan un amplio historial de éxitos protegiendo de lo paranormal a los residentes. Salvaron Nueva York del hombre de malvavisco y defendieron al mundo del espíritu maligno de Gozer. Cuando los niveles de residuos ectoplásmicos ascienden y los fantasmas descienden, ¡ya sabes a quién llamar!



# HISTORY OF ECTO-1

Before getting our flagship Ectomobile back on the road, it's important to understand a little background information on this 1959 Cadillac Miller-Meteor. Originally purchased by Dr. Ray Stantz for \$4,800, this vehicle was perfect for our new paranormal investigation and elimination business. With the help of Dr. Egon Spengler, all the ghostbusting gear was added to make this the ultimate command vehicle. As you can see, the car has seen better days but if you are up for the task, we're ready to believe you!



# L'HISTOIRE DE L'ECTO-1

Avant de remettre notre emblématique Ectomobile sur la route, il faut souligner quelques informations contextuelles sur cette Cadillac Miller-Meteor 1959. Achetée à l'origine par le Dr Ray Stantz pour 4 800 \$, cette voiture était parfaite pour notre nouvelle entreprise d'investigation paranormale et d'éradication. Avec l'assistance du Dr Egon Spengler, l'équipement de chasse aux fantômes a été ajouté pour en faire le véhicule de commandement idéal. Comme vous pouvez le constater, la voiture a connu des jours meilleurs, mais si vous êtes prêt à relever le défi, nous sommes prêts à vous croire !

# HISTORIA DEL ECTO-1

Antes de que nuestro inconfundible Ectomóvil regrese a las calles, es importante que repasemos los datos más interesantes de este Cadillac Miller-Meteor de 1959. El vehículo lo adquirió el Dr. Ray Stantz por \$4800. Era justo lo que necesitábamos para nuestra nueva empresa de investigaciones y eliminaciones paranormales profesionales. Con la ayuda del Dr. Egon Spengler, lo fuimos equipando con dispositivos cazafantasmas hasta convertirlo en el centro de control móvil más eficaz jamás visto. Como puedes observar, el auto ha tenido mejores días, pero, si dices que estás capacitado para afrontar la tarea, ¡estamos listos para creerte!



Nothing draws attention like our spectacular Ectomobile racing around with its lights blazing and siren screeching. You never know who or what you'll meet at the other end!



Rien n'attire l'attention comme notre spectaculaire Ectomobile avec ses gyrophares flamboyants et ses sirènes hurlantes. On ne sait jamais ce qui nous attend à l'autre bout !

Nada llama más la atención que nuestro espectacular Ectomóvil a toda velocidad con las luces parpadeando intensamente y la sirena sonando a todo volumen. ¡Nunca se sabe a quién o qué te encontrarás en el otro barrio!

## PORTABLE COMMAND STATION

To some it may look like a repurposed V8 1959 Cadillac Series 62 Miller-Meteor with 360 horsepower and 4-speed automatic transmission. Which indeed it is. But to us it's also a roving HQ with a mobile laboratory and a portable arsenal containing every weapon at our ghostbusting disposal. Often imitated but never matched, the Ecto-1 has survived everything from catastrophic earthquakes to lava-hot marshmallow fluff! Now it's your job to reassemble and overhaul it...

## ESTACIÓN DE CONTROL PORTÁTIL

A algunos les parecerá simplemente un Cadillac serie 62 Miller-Meteor de 1959 reacondicionado, con su motor V8, sus 360 HP y su transmisión automática de 4 velocidades. Y, en efecto, lo es. Pero, para nosotros, también es un cuartel general sobre ruedas con un laboratorio móvil y un arsenal portátil que contiene todas las armas cazafantasmas a nuestra disposición. Muchas veces imitado y nunca igualado, el Ecto-1 ha sobrevivido a todo, ¡desde catastróficos terremotos hasta cremosos pedazos de malvavisco ardientes como la lava! Ahora, tu misión es rearmarlo y ponerlo en forma...

## POSTE DE COMMANDEMENT PORTATIF

Certains diront qu'elle ressemble à une Cadillac Series 62 Miller-Meteor V8 1959 transformée avec 360 chevaux et une transmission automatique à 4 vitesses. Et ils ont raison. Mais pour nous, c'est aussi un QG ambulant avec un laboratoire mobile et un arsenal portable contenant toutes les armes à notre disposition. Souvent imitée mais jamais égale, l'Ecto-1 a survécu à tout, des tremblements de terre catastrophiques aux morceaux de guimauve bouillants ! Maintenant, c'est à vous de la remonter et de la réviser...



1/2" ISOMETRIC  
ECTO 1

SCALE: 1/2" = 1'  
13 SEP 89,

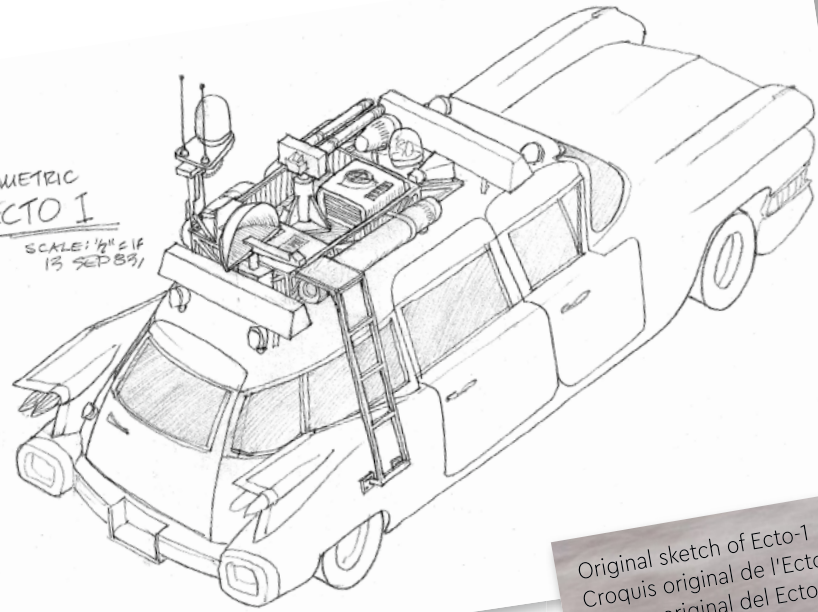

Original sketch of Ecto-1  
Croquis original de l'Ecto-1  
Boceto original del Ecto-1

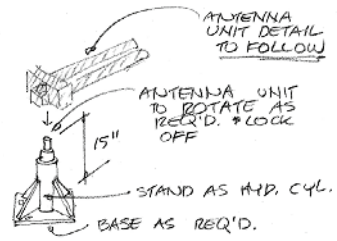

1/2" ISOMETRIC -  
T.V. ANTENNA

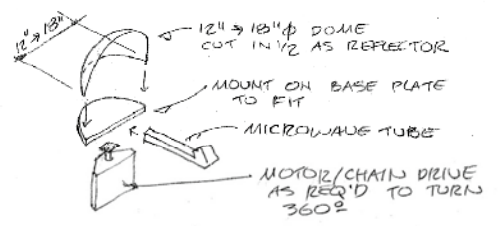

1/2" ISOMETRIC -  
DIRECTIONAL ANTENNA

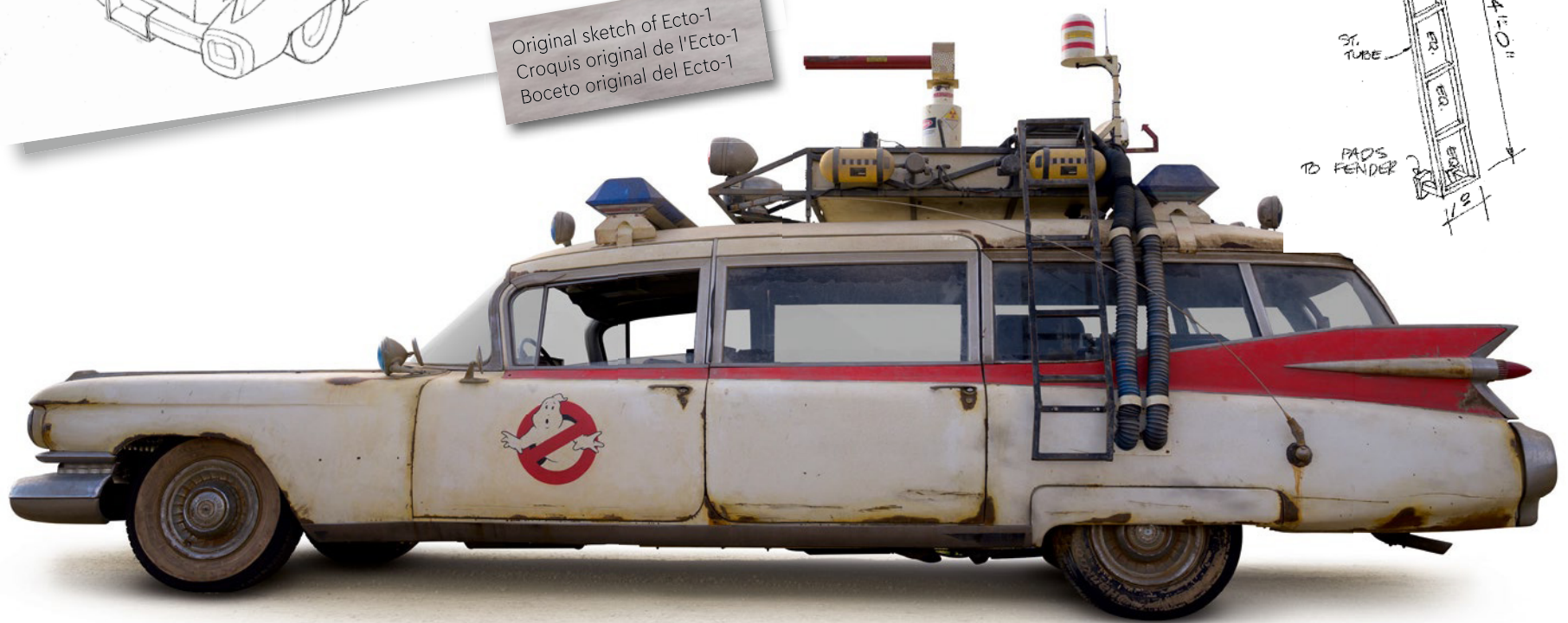
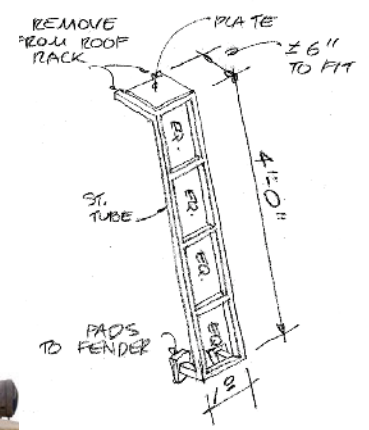

# MIKE THE MECHANIC

Meet Mike Psiaki, Ghostbuster and LEGO® Ectomobile builder. He designed this latest update of the Ecto-1 and would have completed it if he hadn't met with an unfortunate protonic reversal accident. His biggest challenge was capturing the complicated curves of the Cadillac with boxy LEGO elements. Like all true scientists, engineers and LEGO builders, Mike was an ace at adapting and improvising. The ladder for his Ecto-1 came from 2 classic LEGO window frames stacked on top of each other, while the front grille is actually made up of more than 40 silver roller skates!



# MIKE LE MÉCANICIEN

Mike Psiaki est un chasseur de fantômes et le constructeur de l'Ectomobile LEGO®. Il a conçu cette dernière version de l'Ecto-1, et l'aurait terminée s'il n'avait pas connu un malheureux accident d'inversion protonique. Son plus grand défi a été de rendre les courbes complexes de la Cadillac avec des éléments LEGO angulaires. Comme tous les bons scientifiques, ingénieurs et constructeurs LEGO, Mike est un pro de l'adaptation et de l'improvisation. L'échelle de son Ecto-1 est faite de 2 cadres de fenêtre LEGO classiques empilés l'un sur l'autre, tandis que la calandre avant est en fait composée de plus de 40 patins à roulettes argentés !

# MIKE EL MECÁNICO

Conoce a Mike Psiaki, cazafantasmas y constructor del Ectomóvil LEGO®. Diseñó esta última versión actualizada del Ecto-1, y la habría terminado si no hubiera sufrido un desafortunado accidente de inversión protónica. Su mayor desafío fue capturar las complicadas formas curvas del Cadillac con las marcadas aristas de los elementos LEGO. Como todos los verdaderos científicos, ingenieros y constructores LEGO, Mike es un experto adaptando e improvisando. La escalera de su Ecto-1 proviene de 2 marcos de ventana LEGO clásicos apilados uno sobre el otro y la parrilla delantera se compone, en realidad, ¡de más de 40 patines plateados!







## ECTOMOBILE OVERVIEW

Now that you're up for the task, it's time to take a deep dive into the particulars of our impressive quick-response vehicle and all its sophisticated equipment. The detailed schematic and reference materials contained over the next pages should allow you to move forward ... hopefully at the wheel of a completed Ectomobile!

## VUE D'ENSEMBLE DE L'ECTOMOBILE

Maintenant que vous êtes prêt à vous lancer, il est temps de vous présenter plus en détail notre impressionnant véhicule d'intervention rapide et son équipement sophistiqué. Les schémas détaillés et les documents de référence contenus dans les prochaines pages devraient vous permettre d'aller de l'avant... au volant d'une Ectomobile complète, nous l'espérons !

## DESCRIPCIÓN GENERAL DEL ECTOMÓVIL

Ahora que te sientes preparado para la tarea, llegó el momento de profundizar en las características de nuestro impresionante vehículo de respuesta rápida y todo su sofisticado equipo. Los detallados materiales de referencia y esquemas que aparecen en las siguientes páginas te permitirán avanzar, con suerte... ¡al volante de un Ectomóvil terminado!

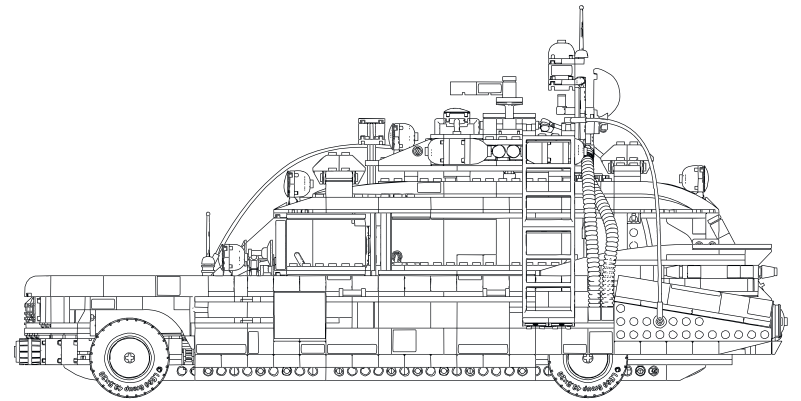

This model may only be a smaller scale version of the real thing, but it's got everything you need for ghostbusting! There are 2,352 pieces in this set.

Ce modèle n'est peut-être qu'une version à petite échelle de la vraie voiture, mais il contient tout ce qu'il vous faut pour chasser les fantômes ! Cet ensemble contient 2 352 pièces.

Este modelo puede ser solo una versión a escala más pequeña del vehículo real, ¡pero tiene todo lo que necesitas para ir a cazar fantasmas! Hay 2352 piezas en este set.

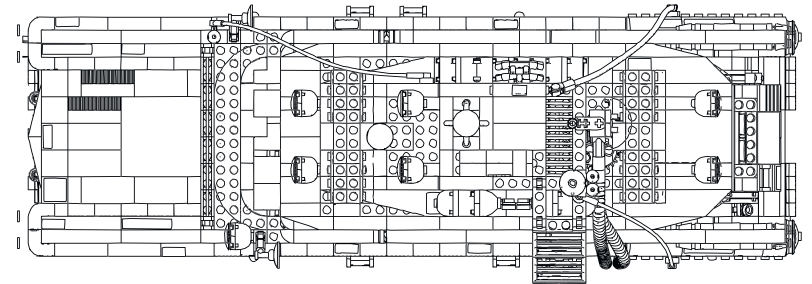

Don't panic! Take your time and follow the instruction manual. You can do this!

Ne paniquez pas ! Prenez votre temps et suivez le manuel d'instructions. Vous pouvez y arriver !

¡No te angusties! Tómate tu tiempo y sigue el manual de instrucciones. ¡Puedes hacerlo!

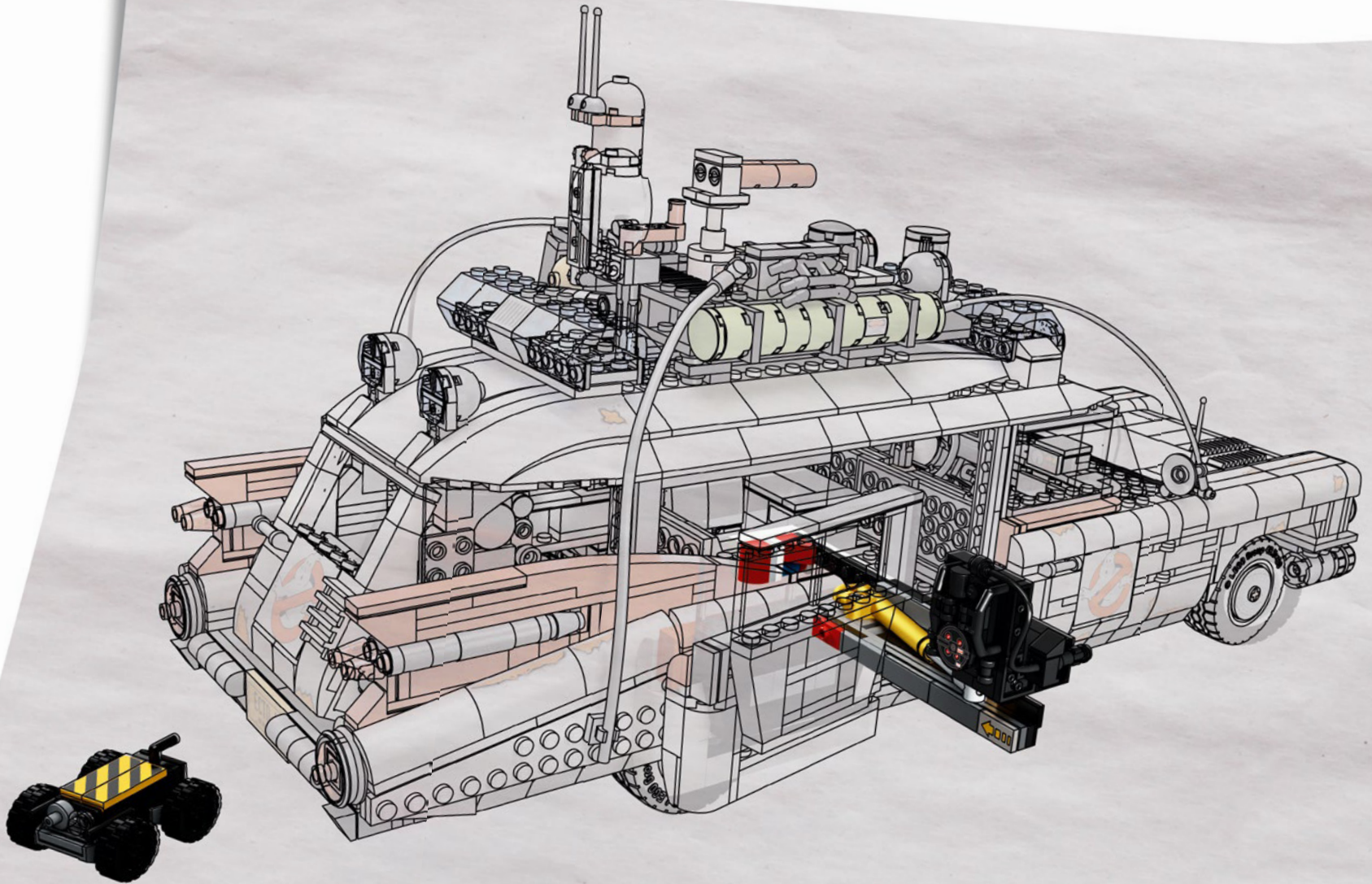



[LEGO.com/brickseparator](https://www.lego.com/brickseparator)

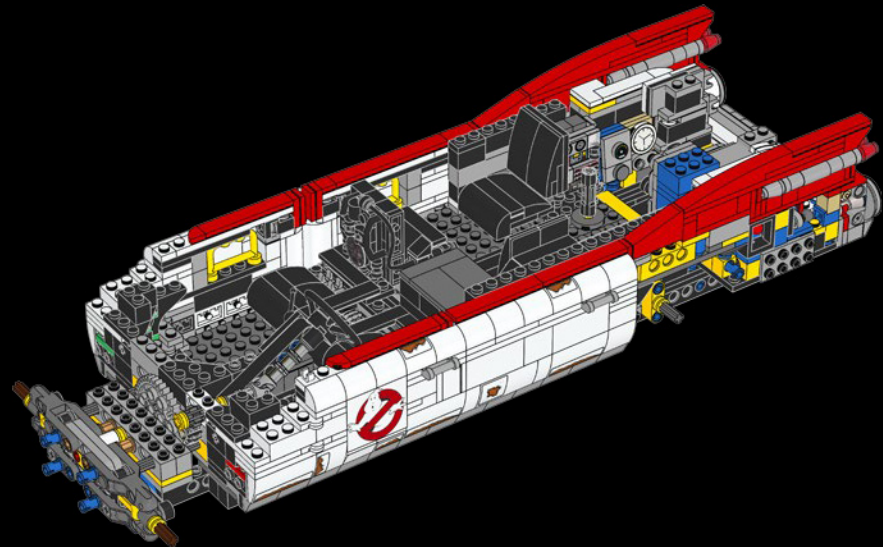
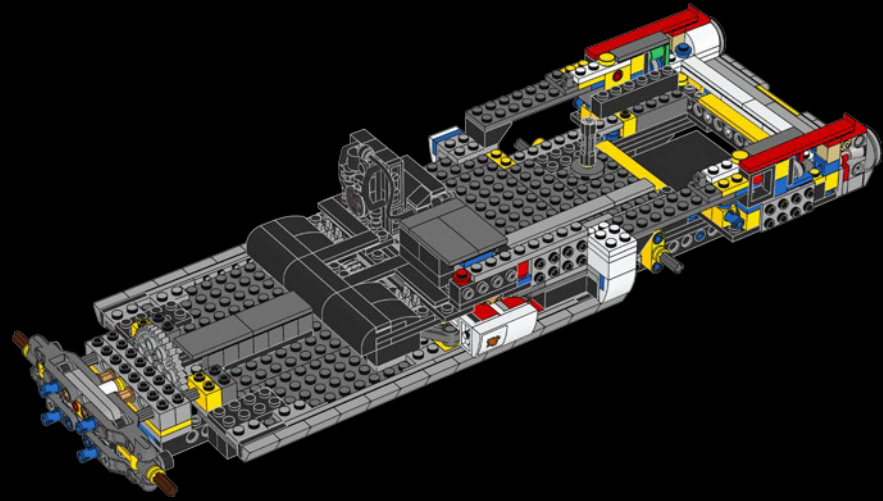
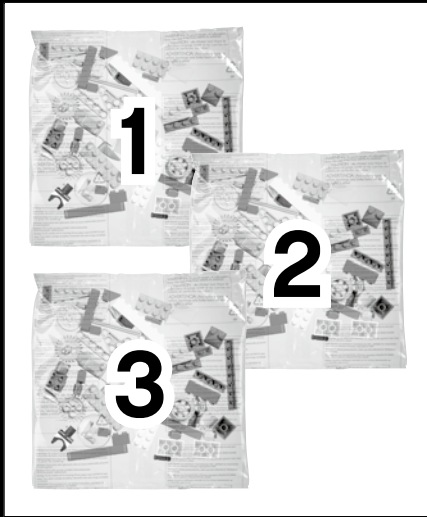

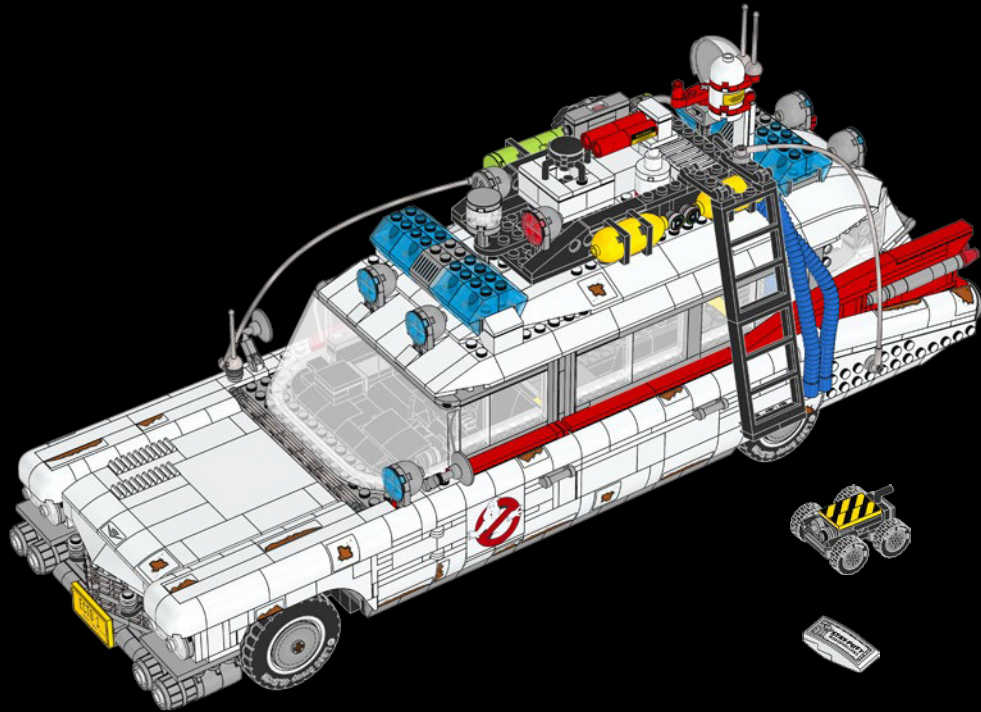
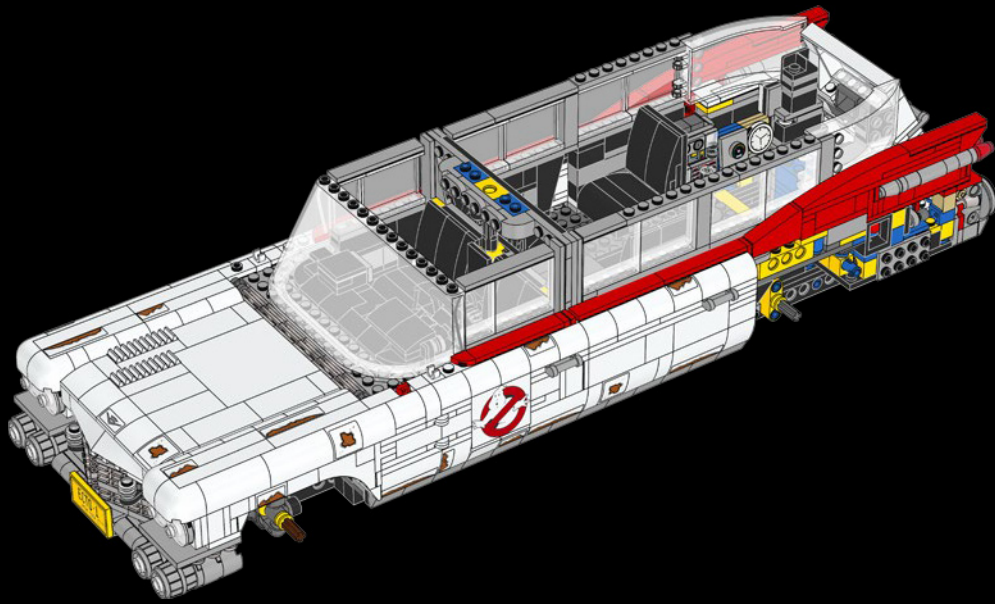

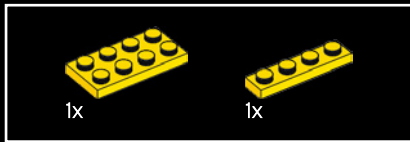
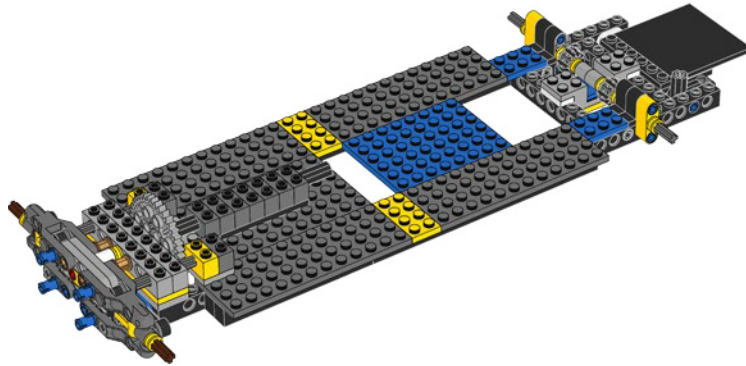

1

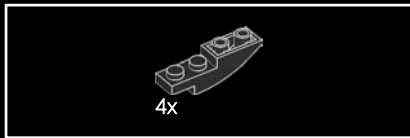
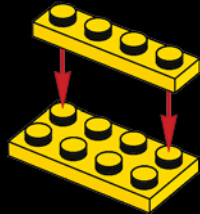

2

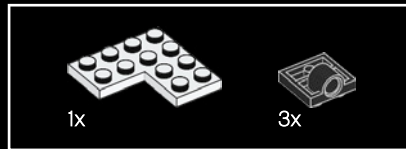
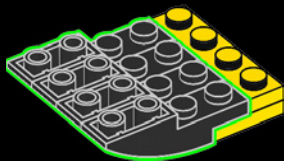

3

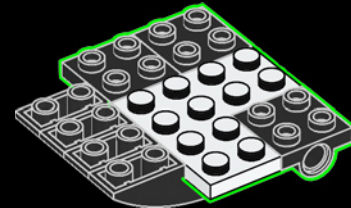

4

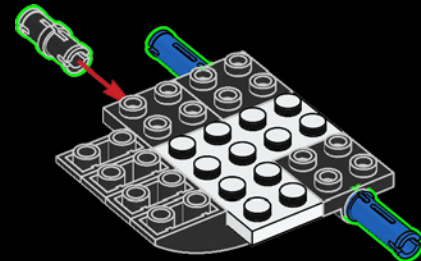



5

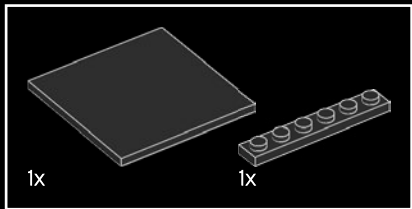
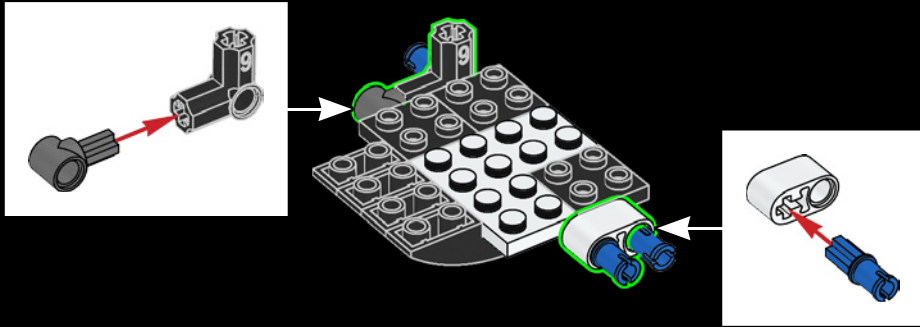

6

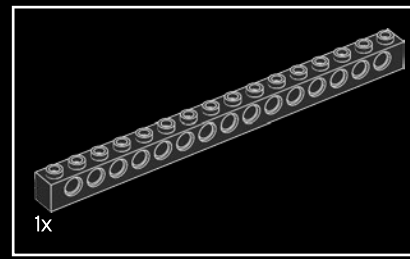
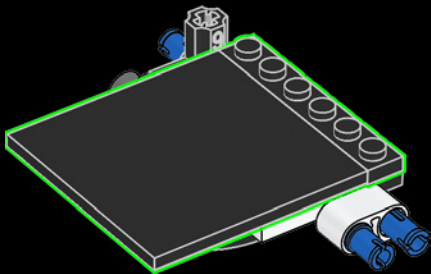

7

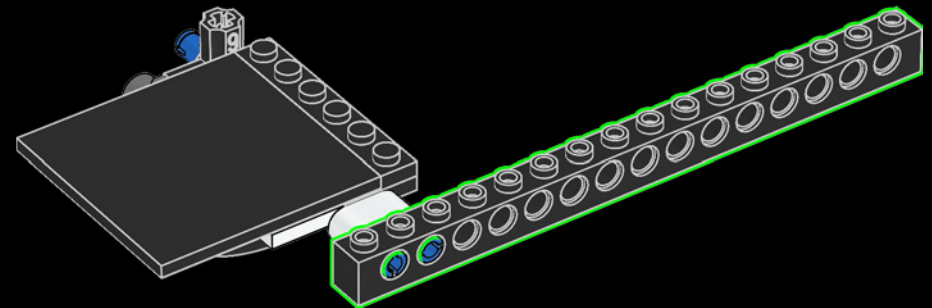



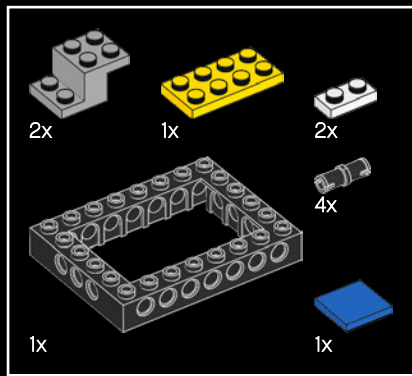

8

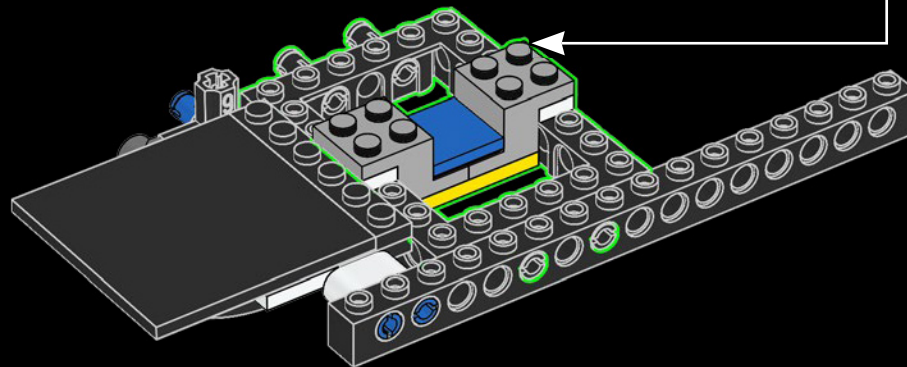
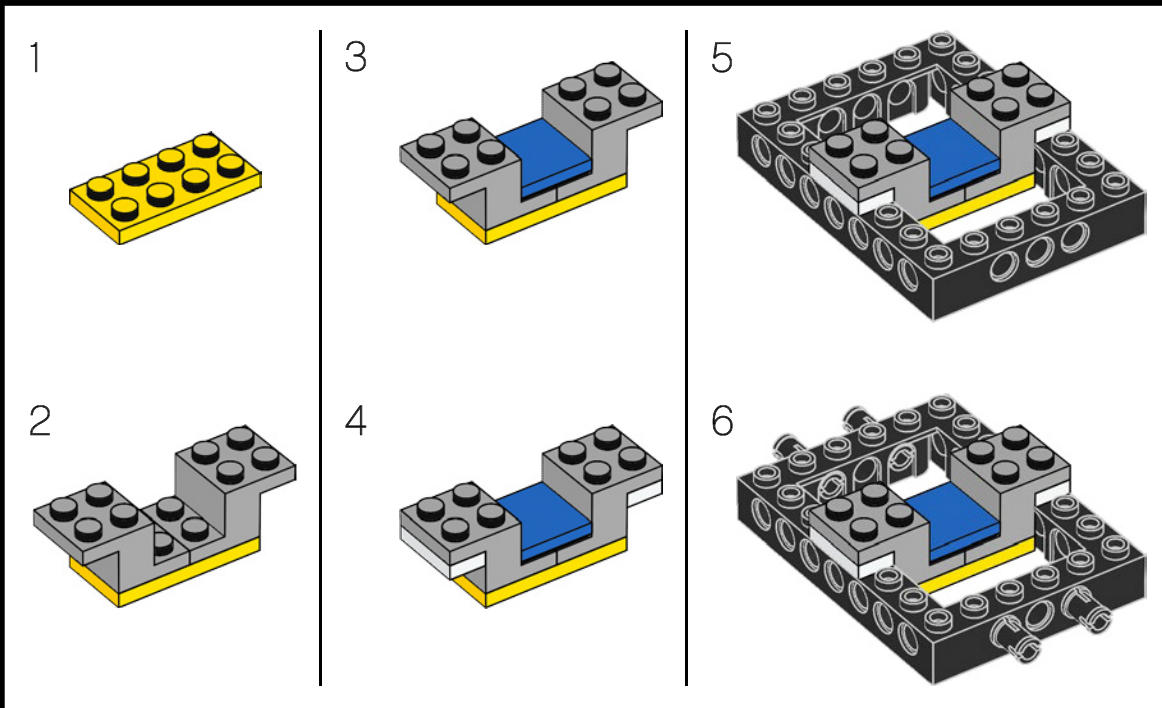

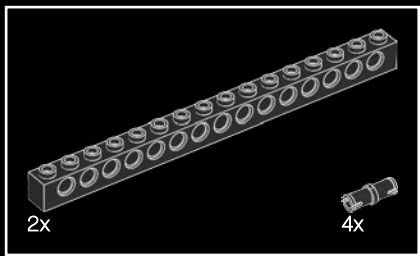

9

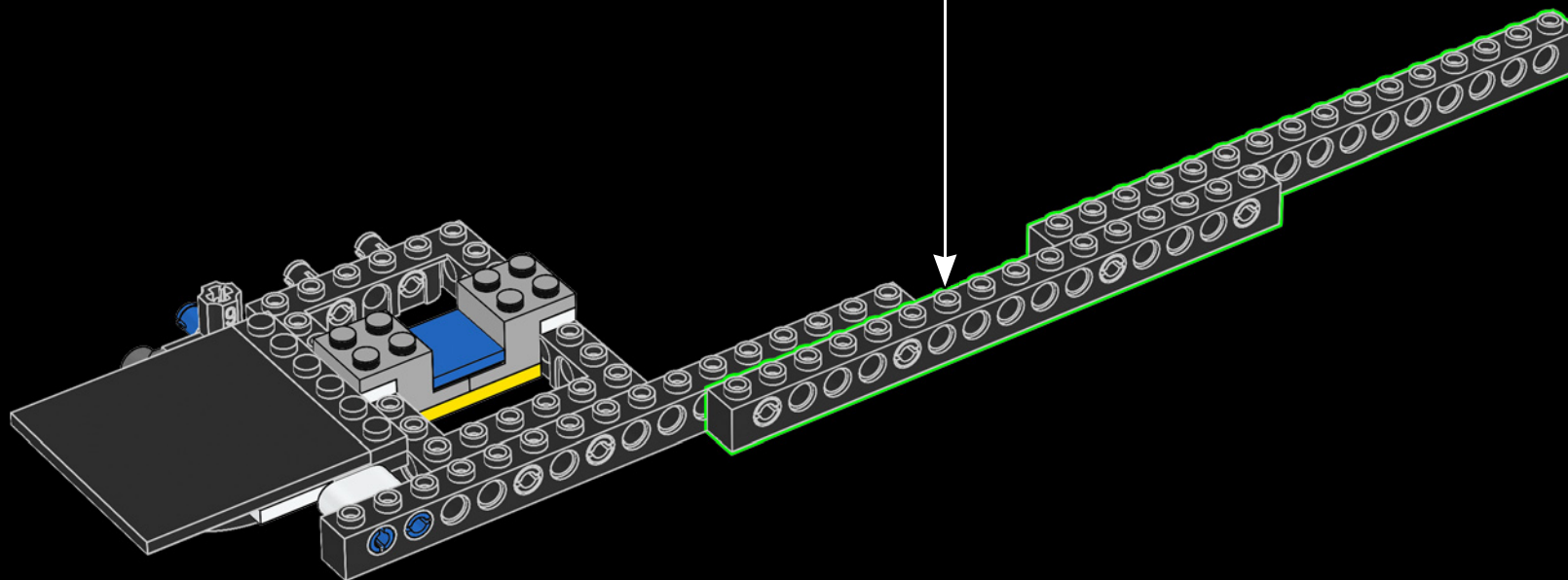
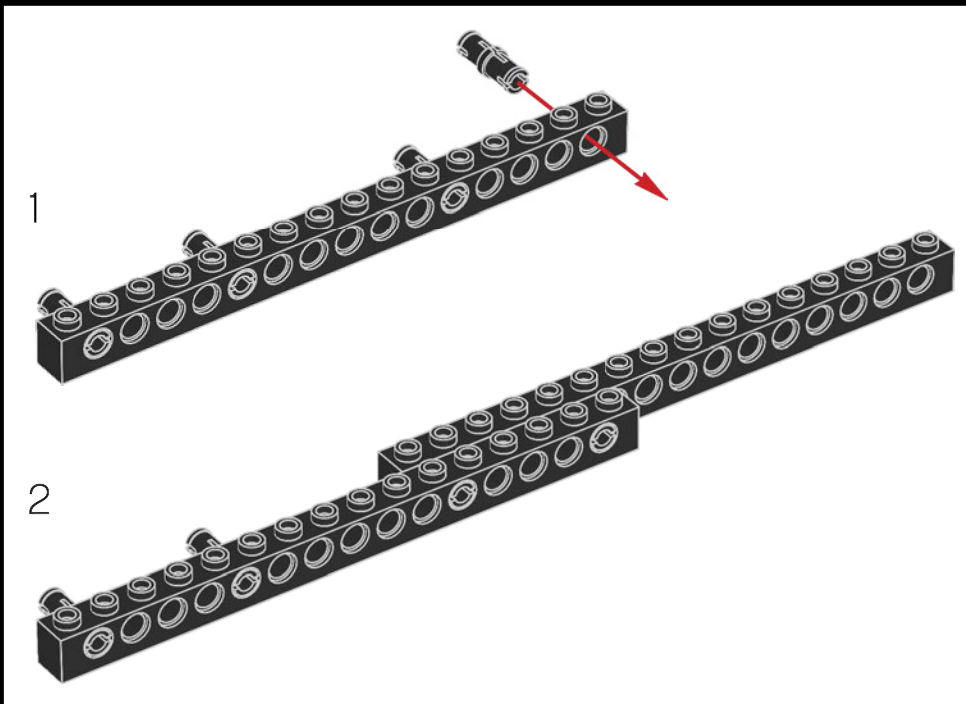

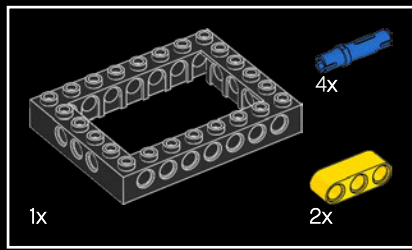

10

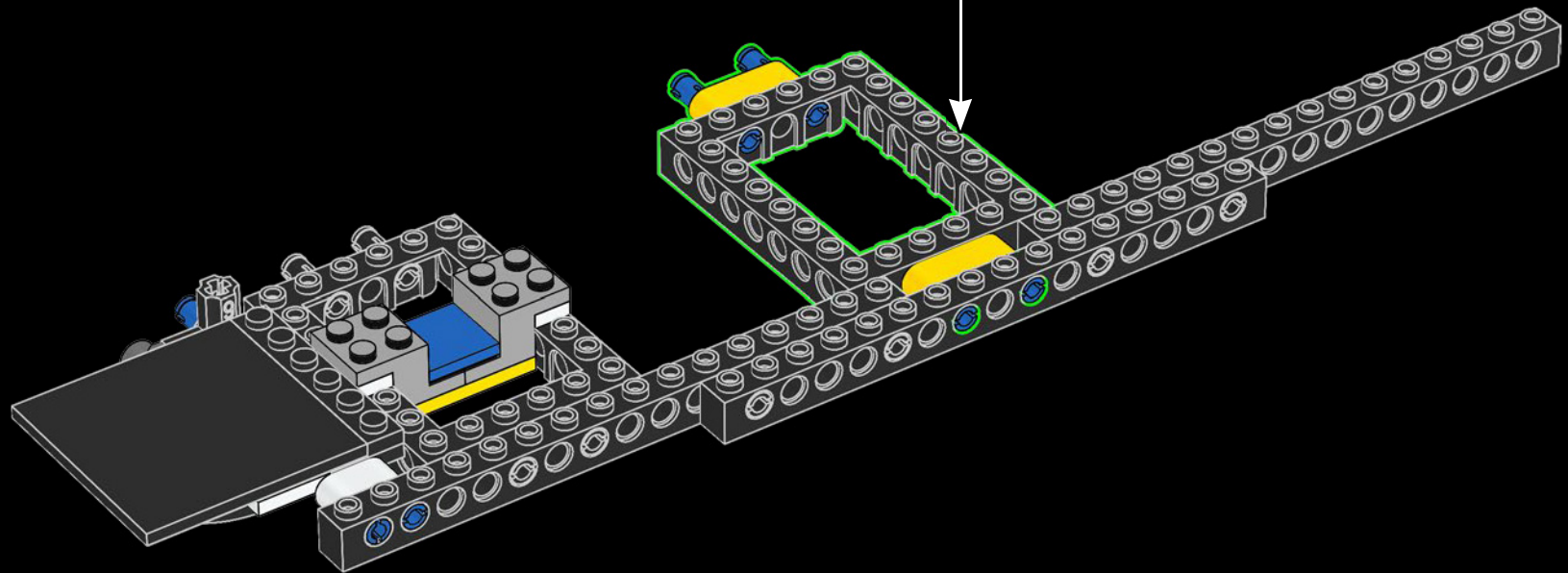
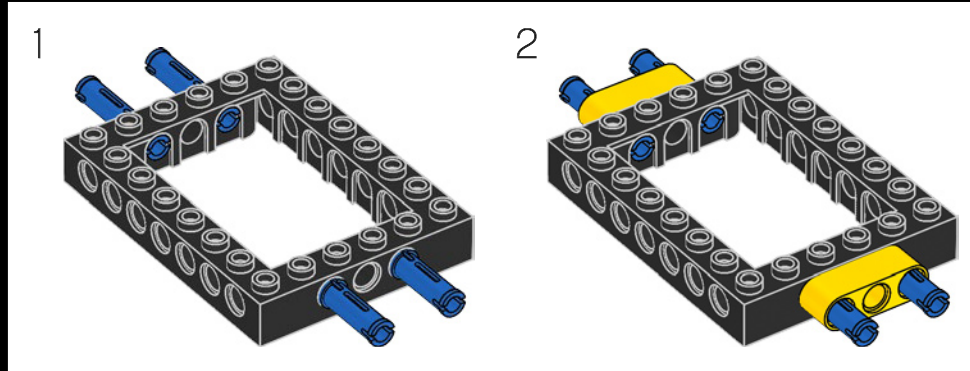

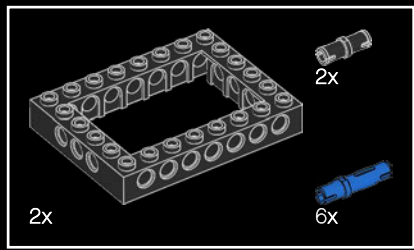

11

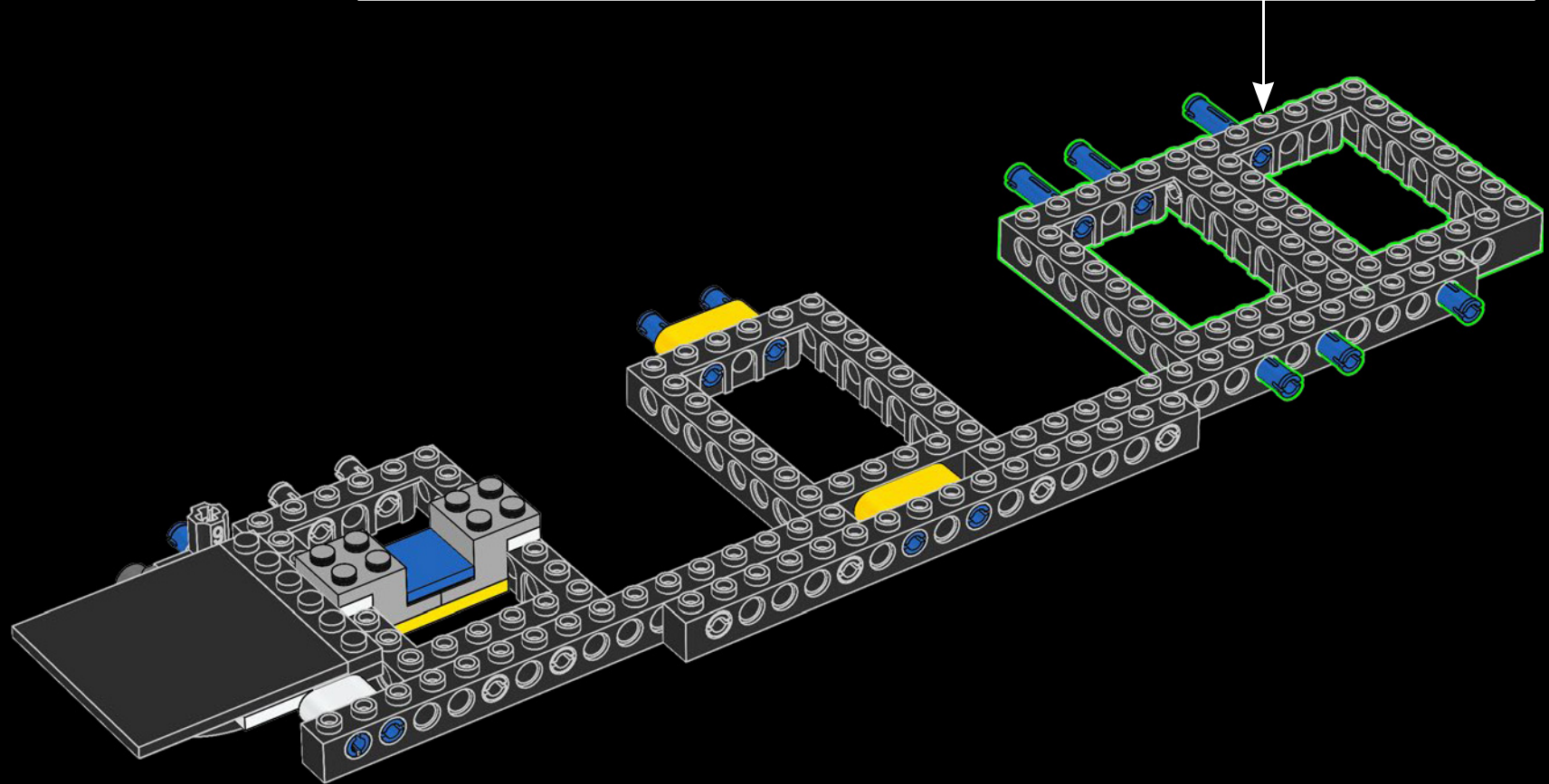
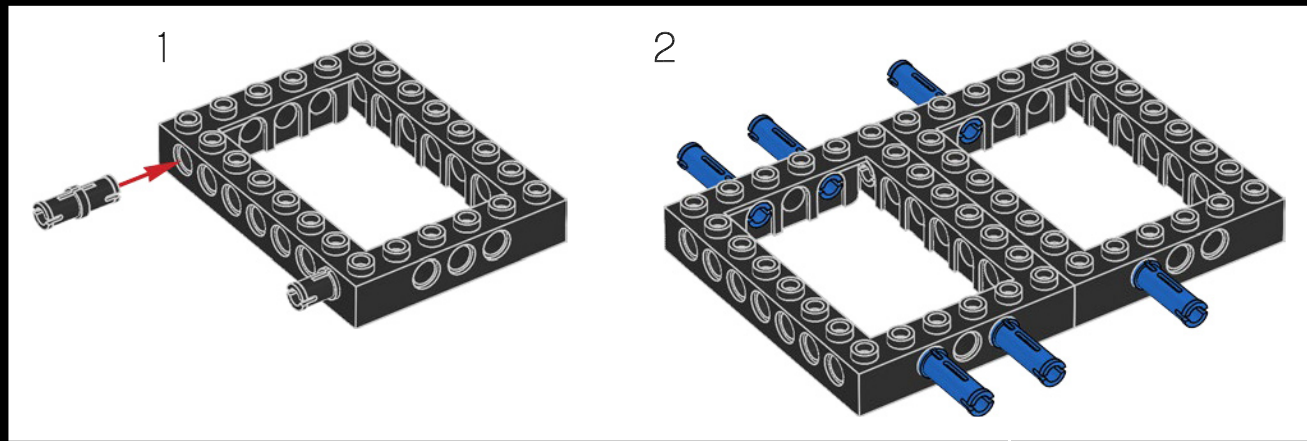

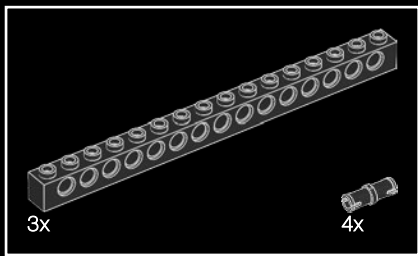

12

1

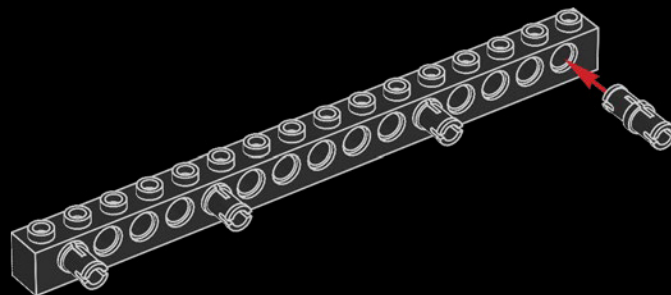

2

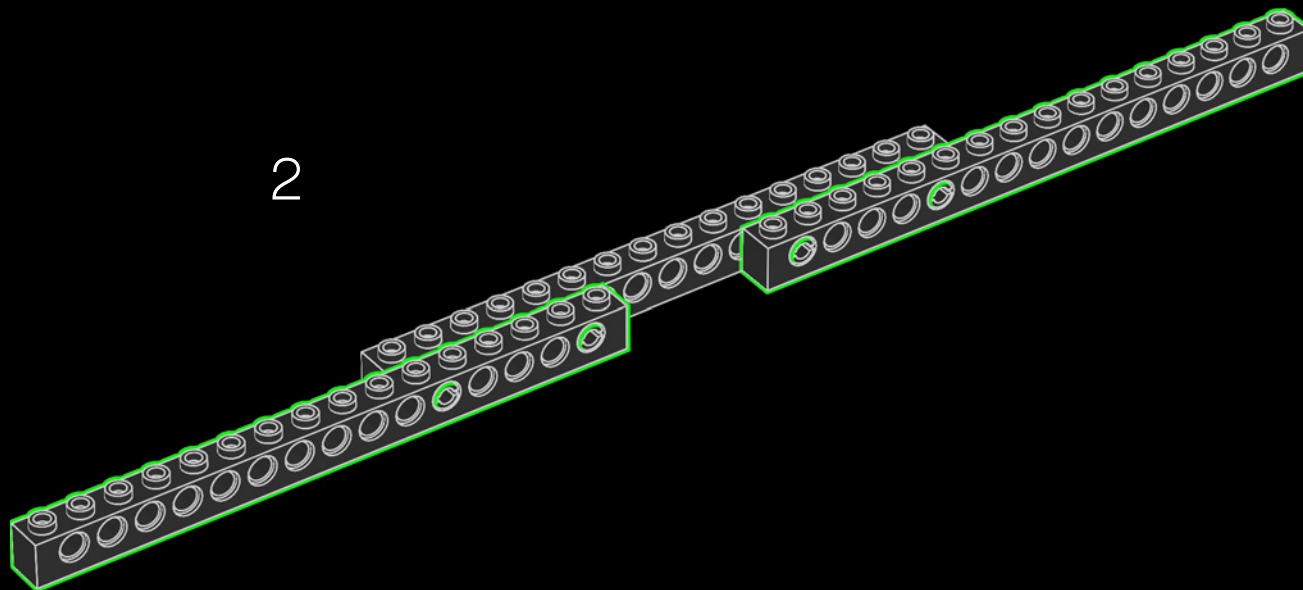

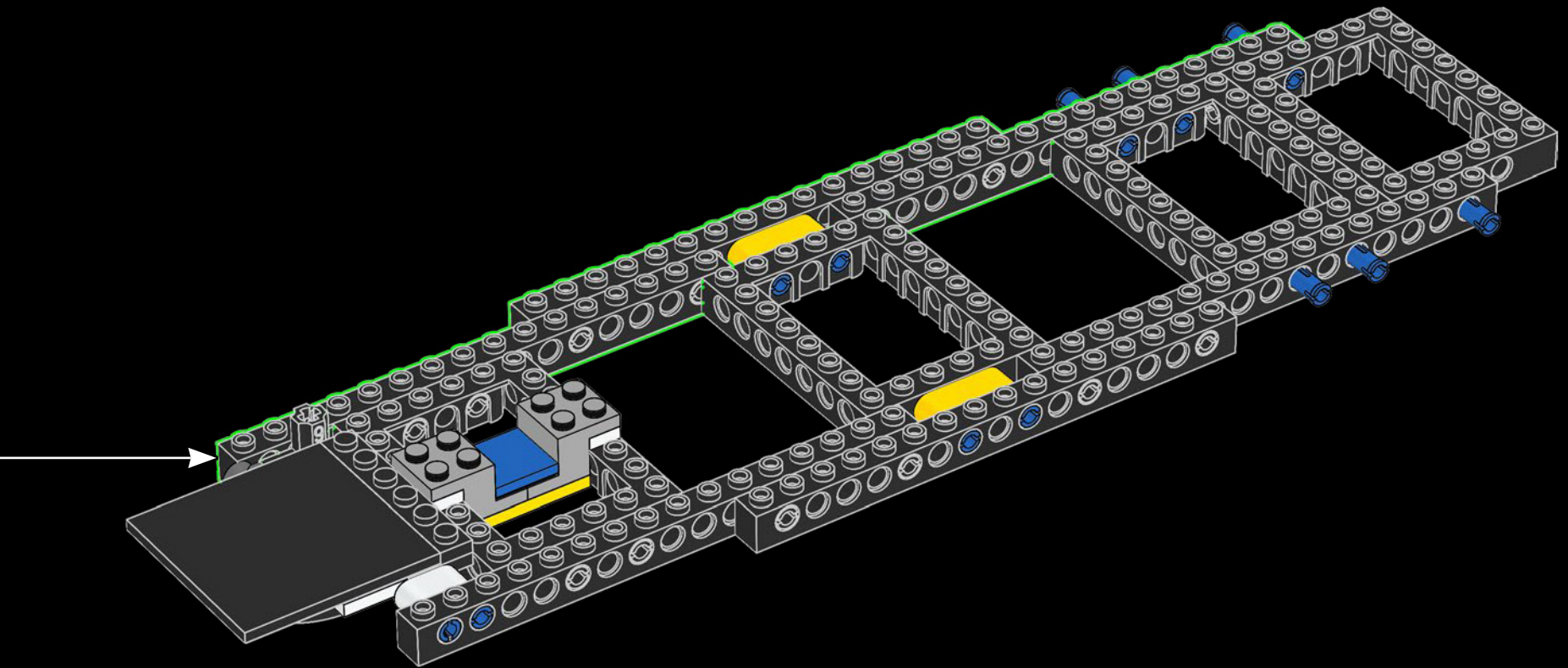

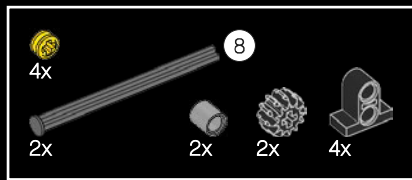

13

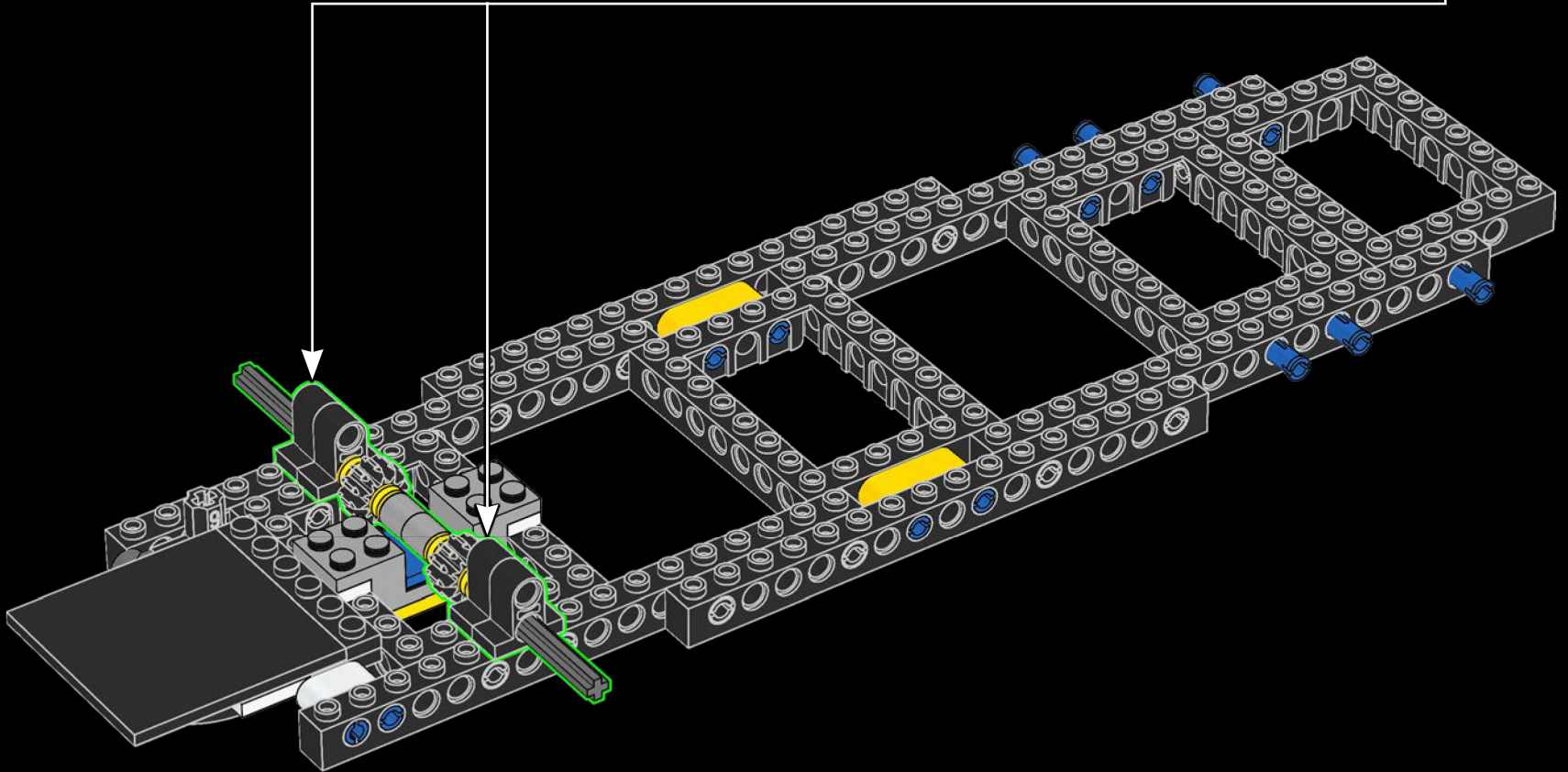
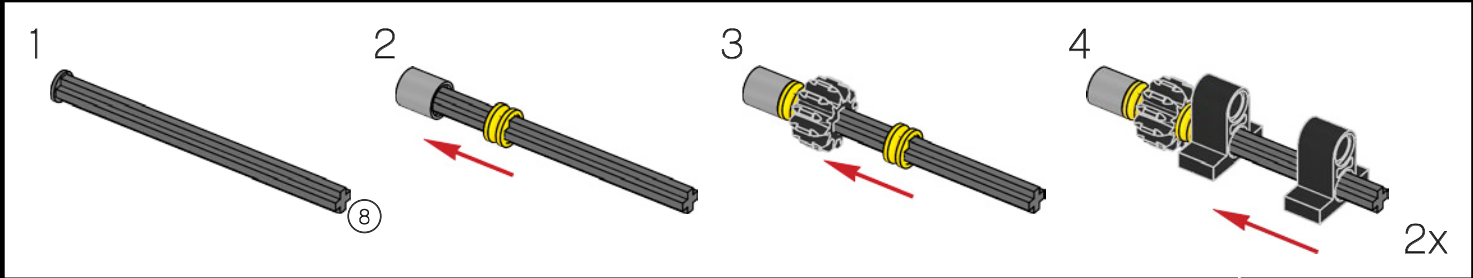

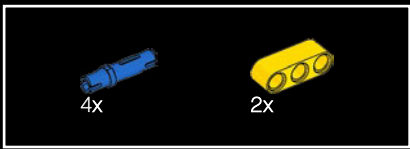

14

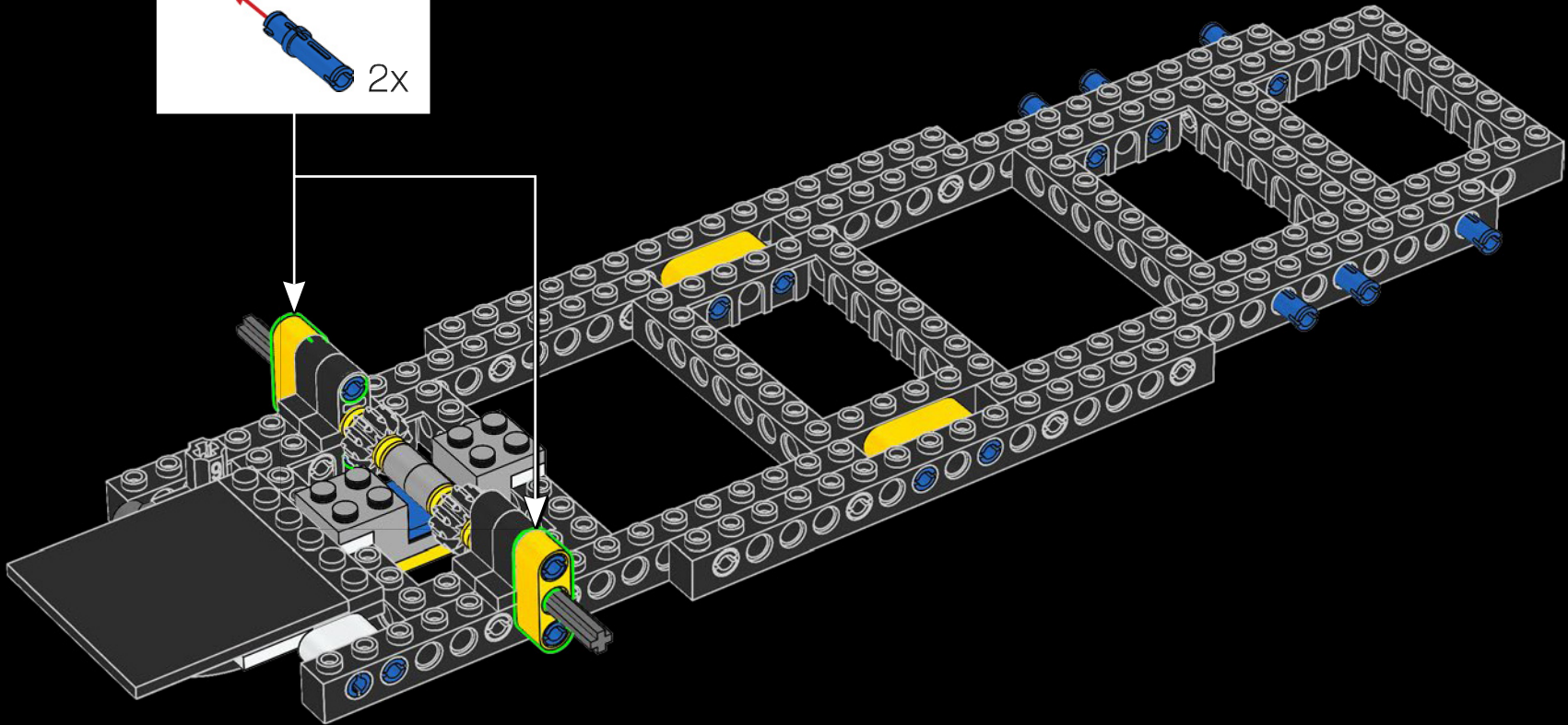
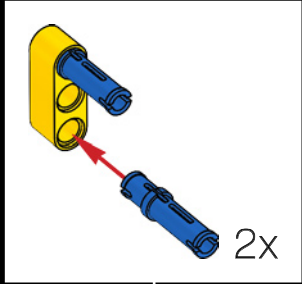



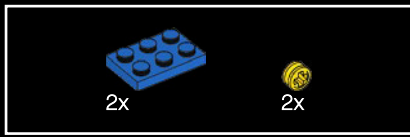

15

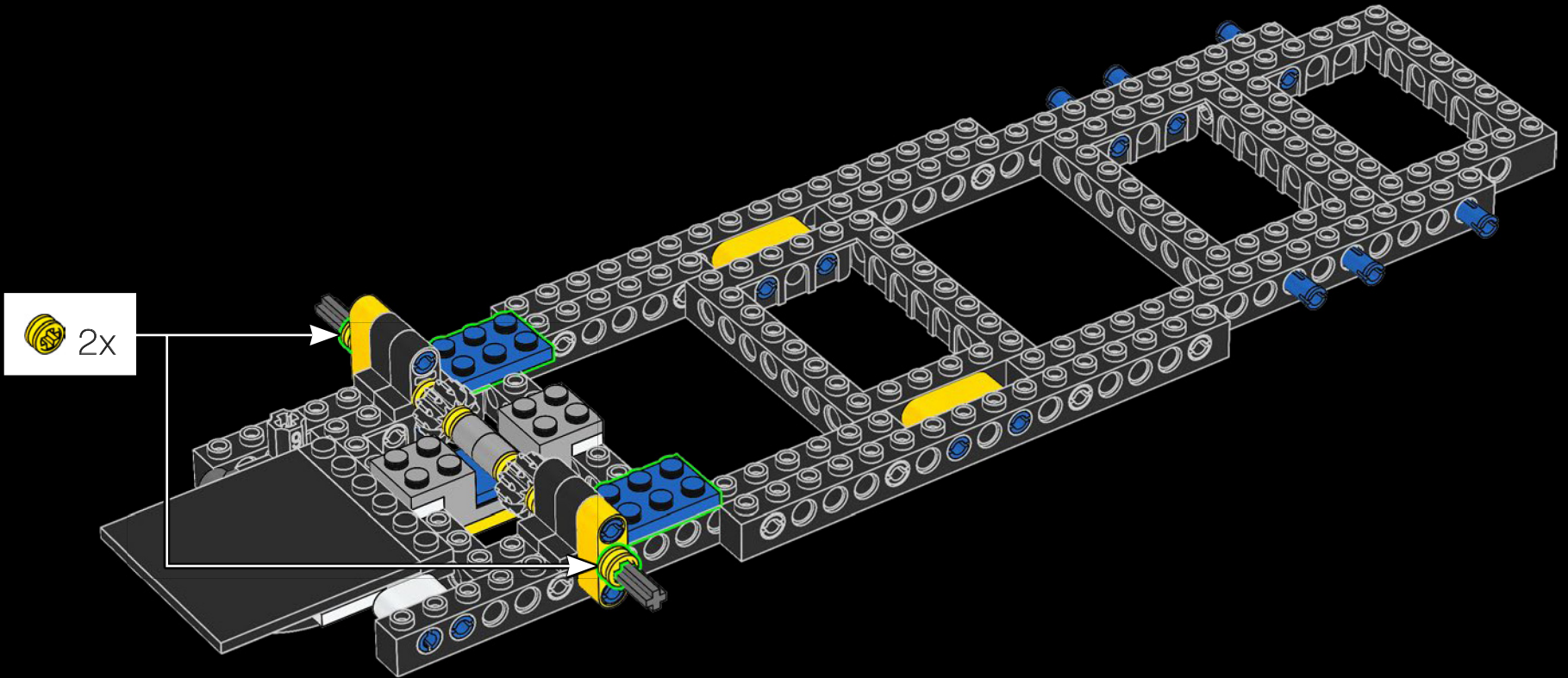

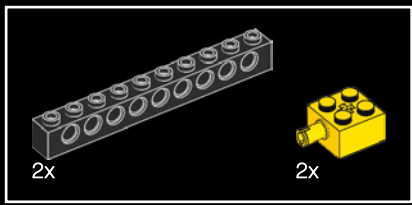

16

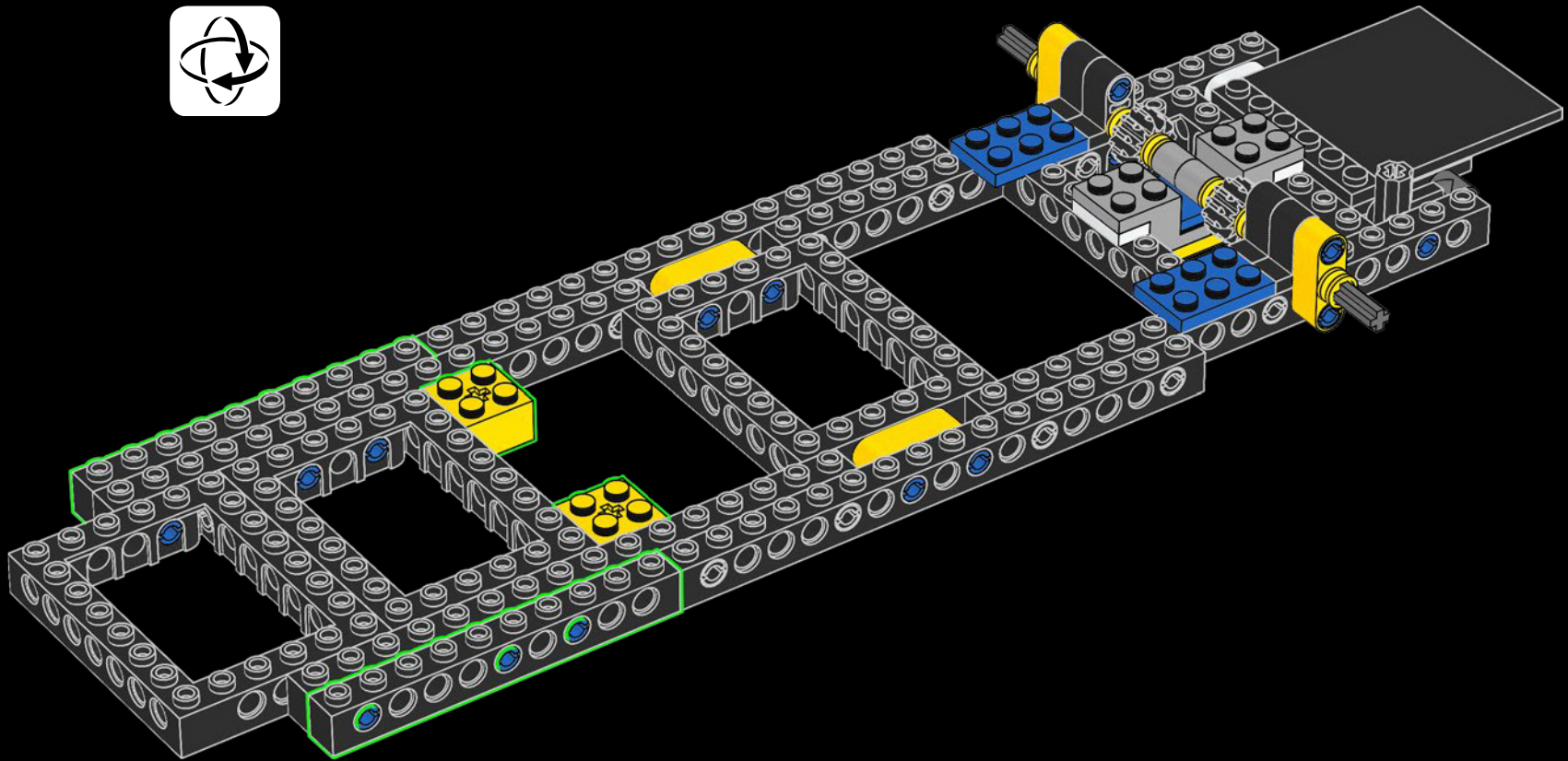

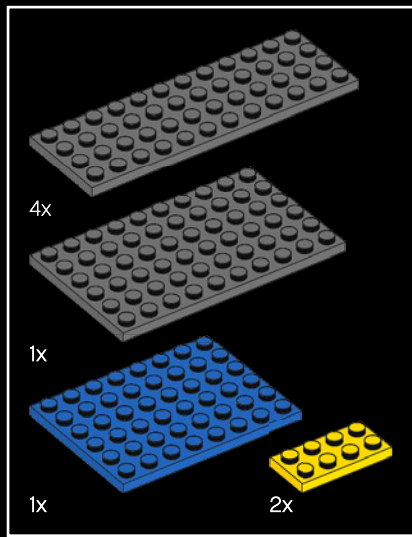

17

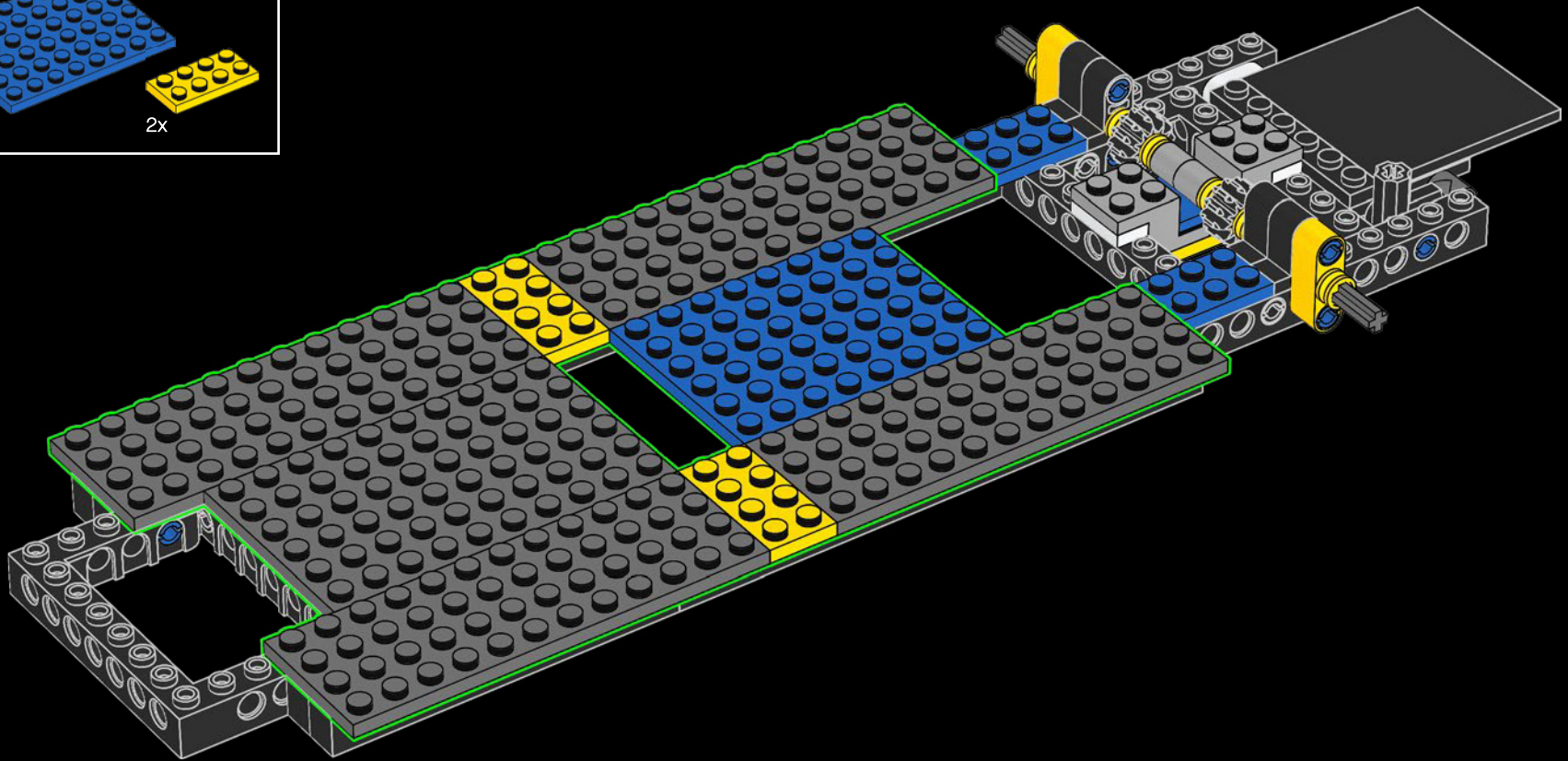

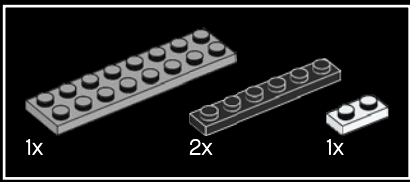

18

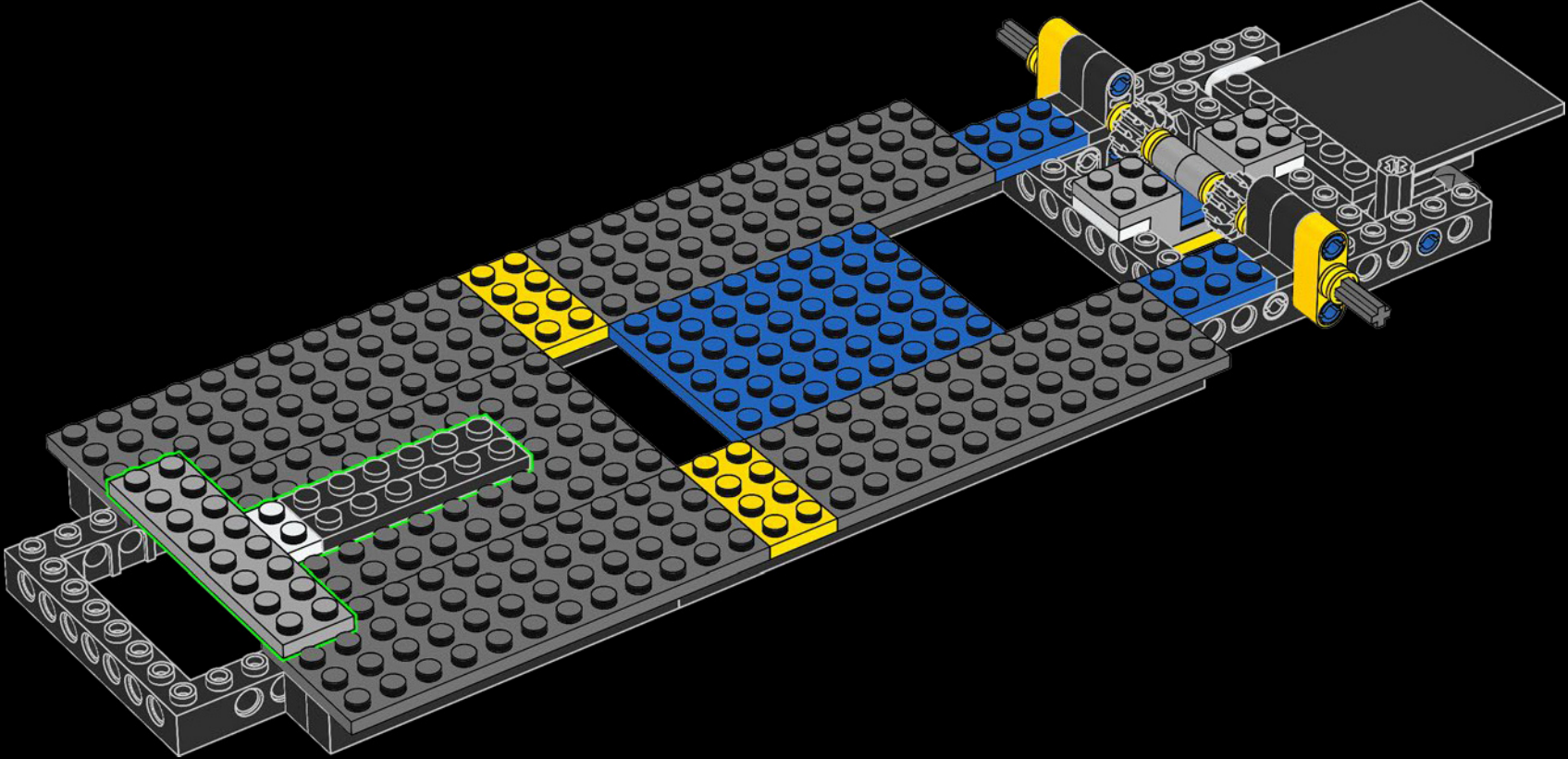

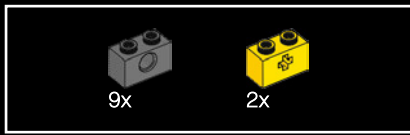

19

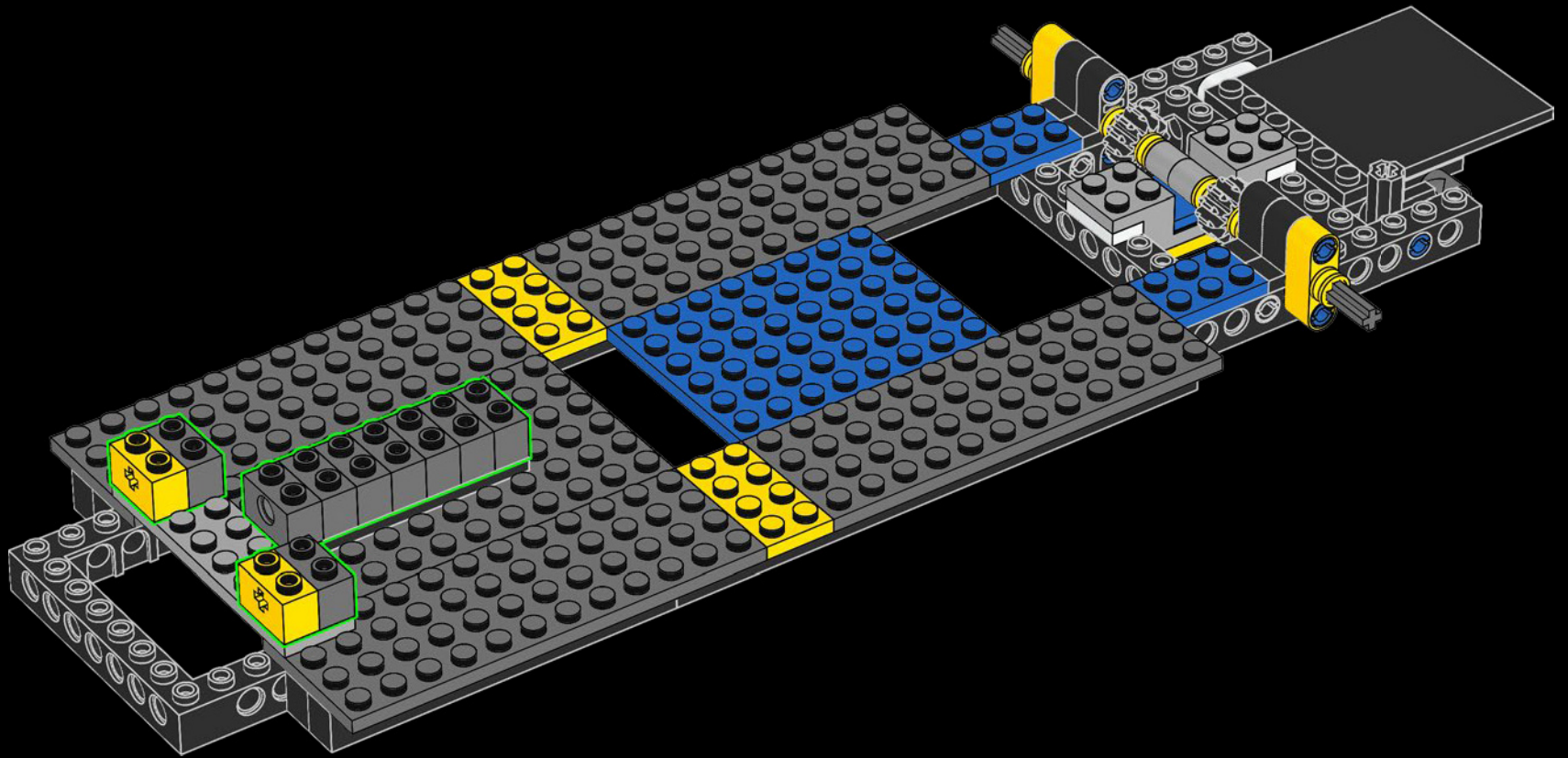

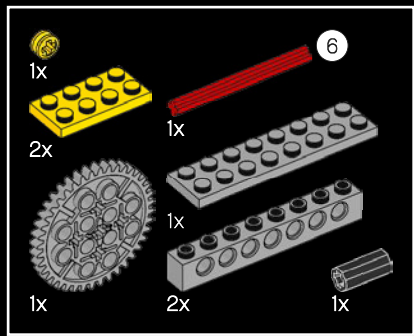

20

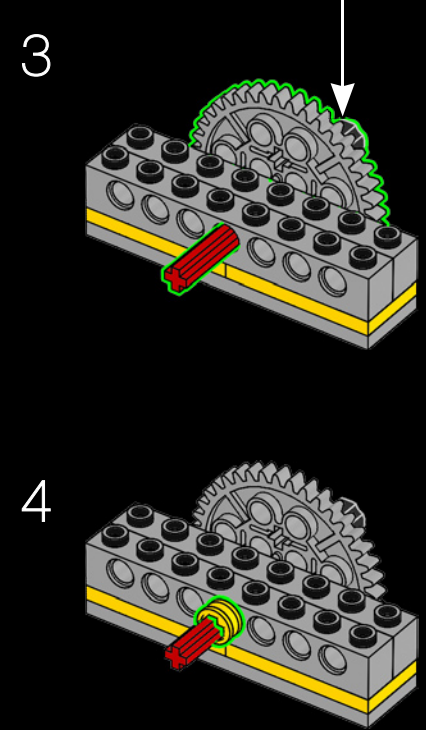
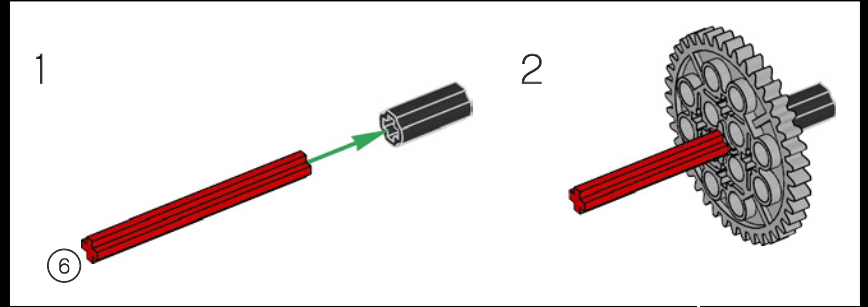
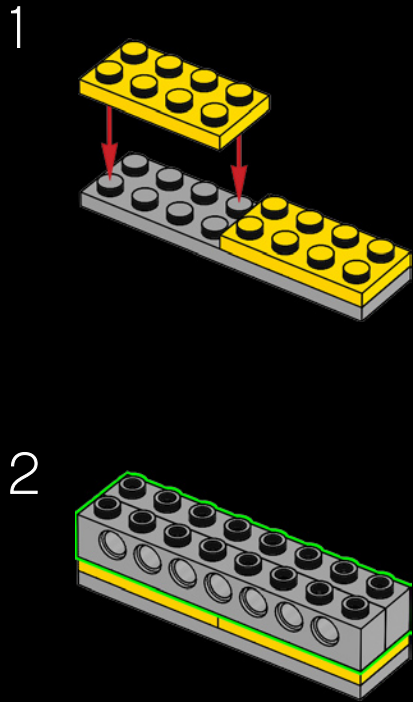

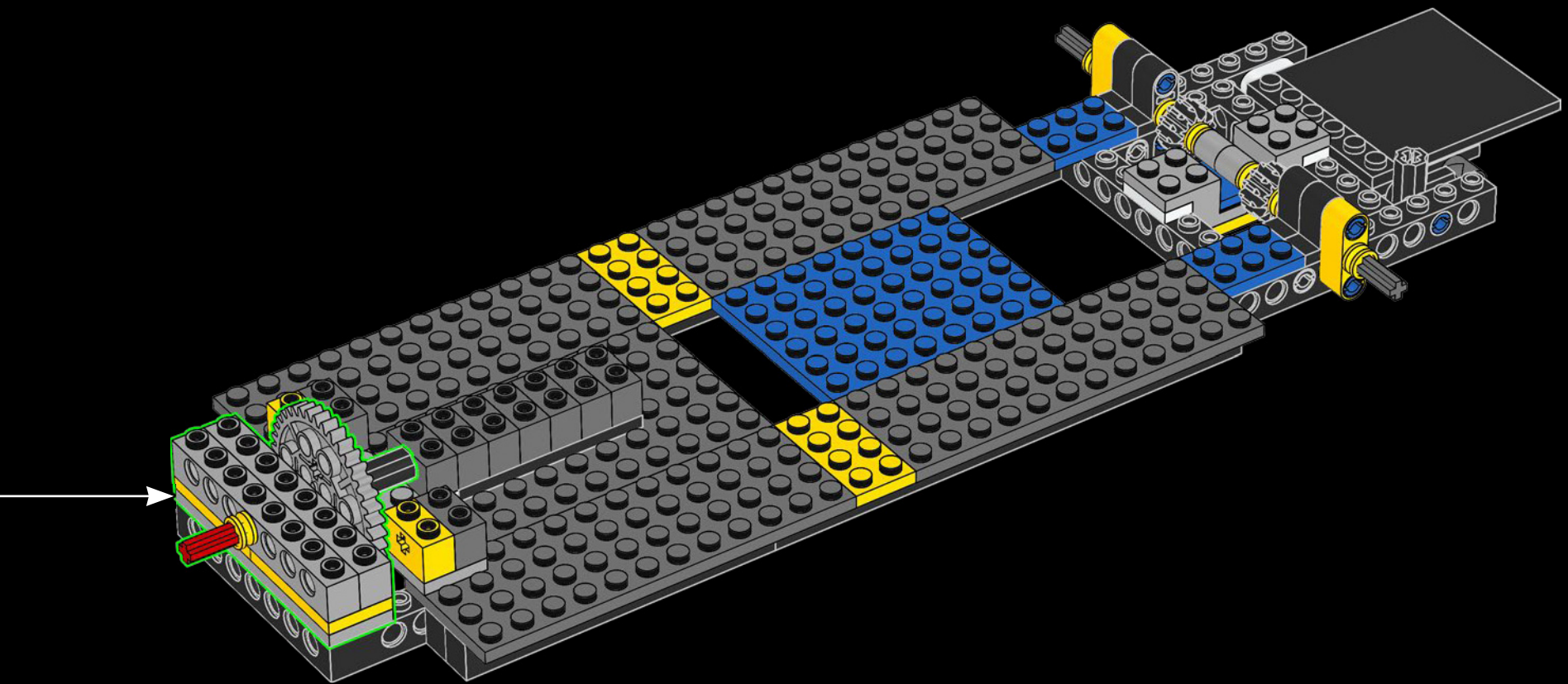

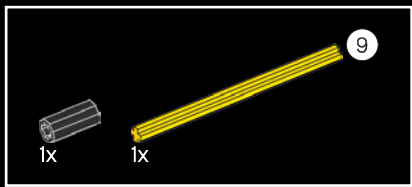

21

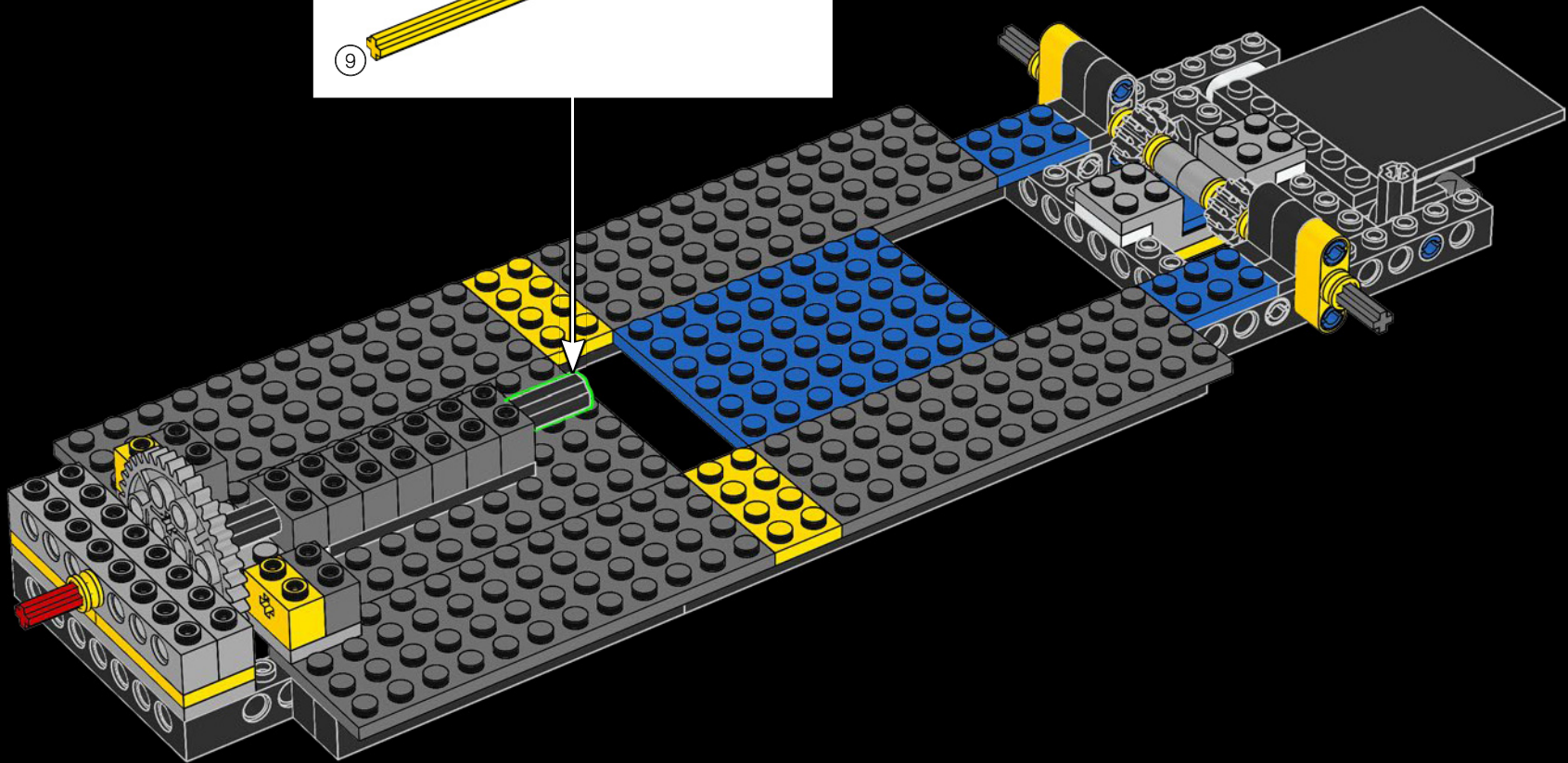
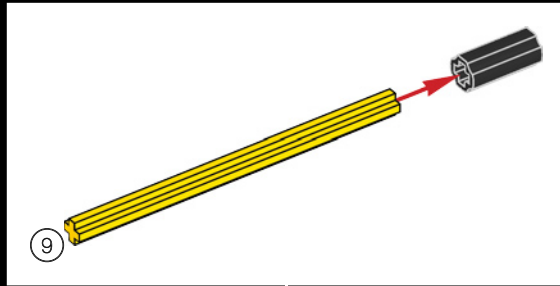



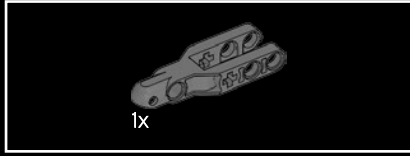
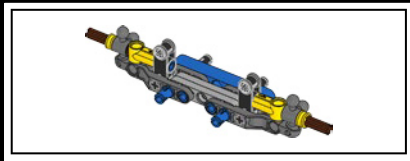

22

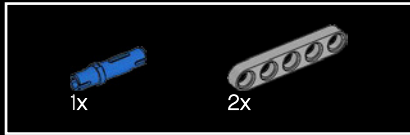

23

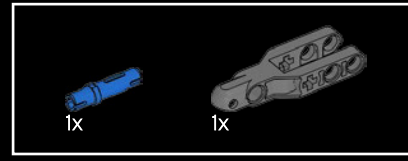
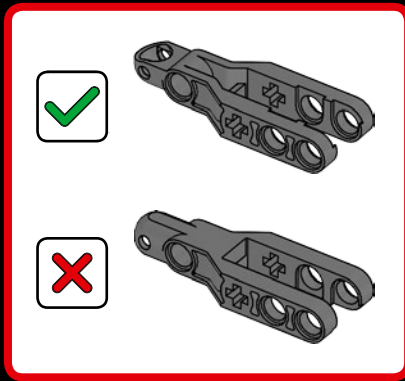
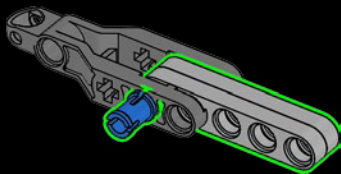

24

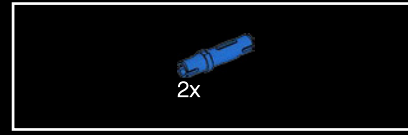
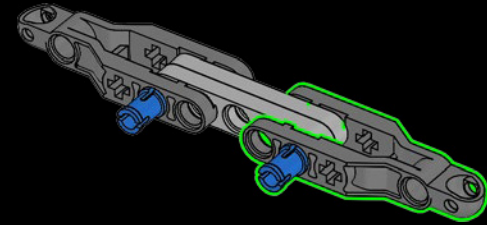

25

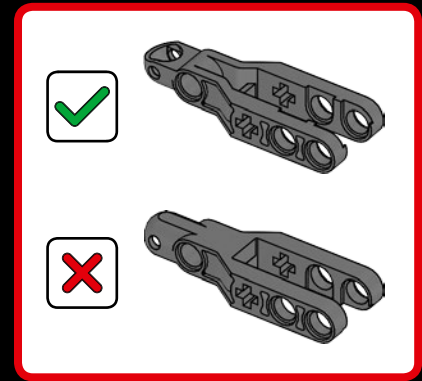
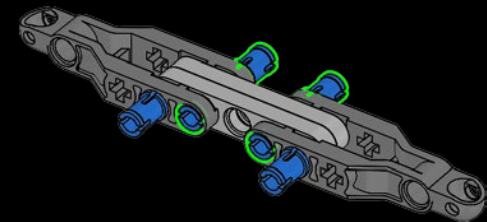

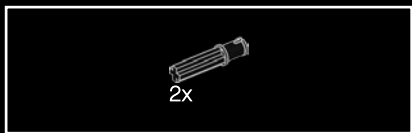

26

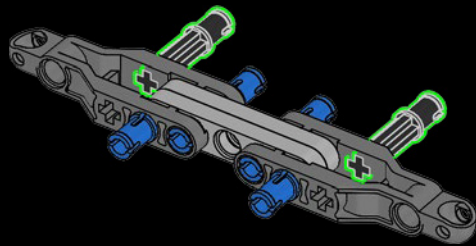

27

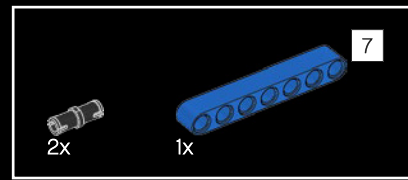
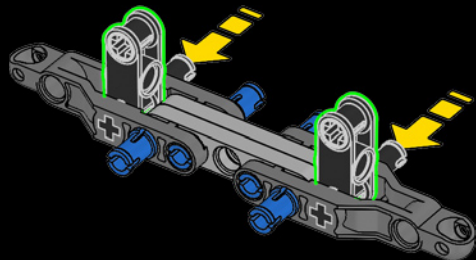

28

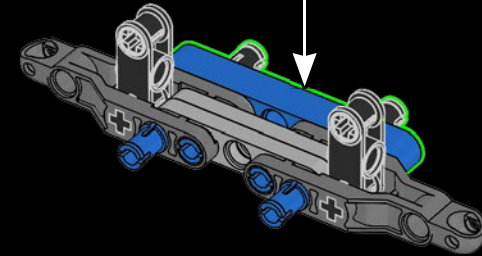
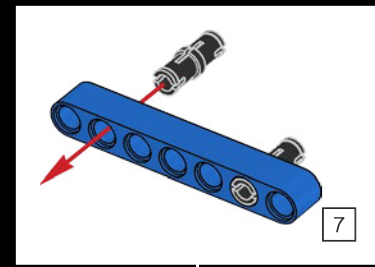

29

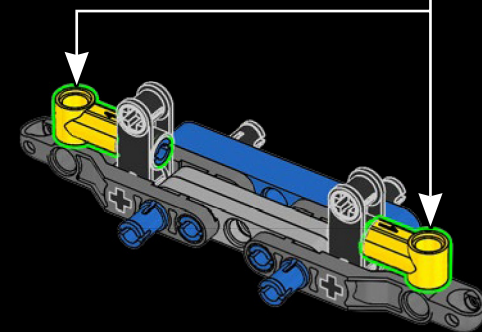
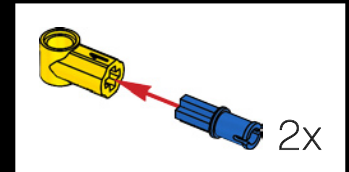



30

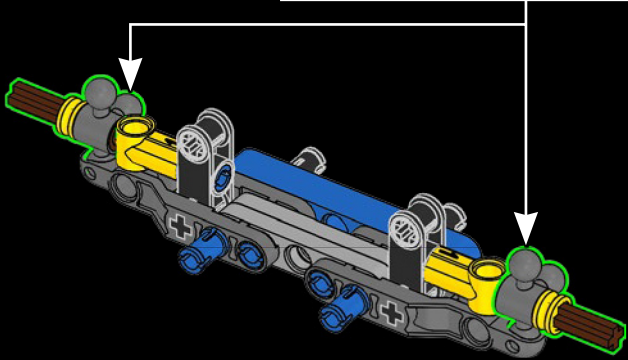
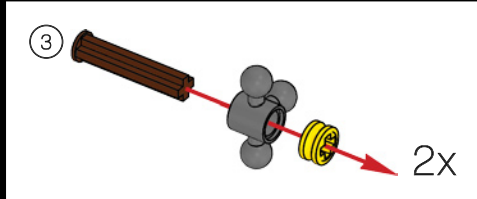

31

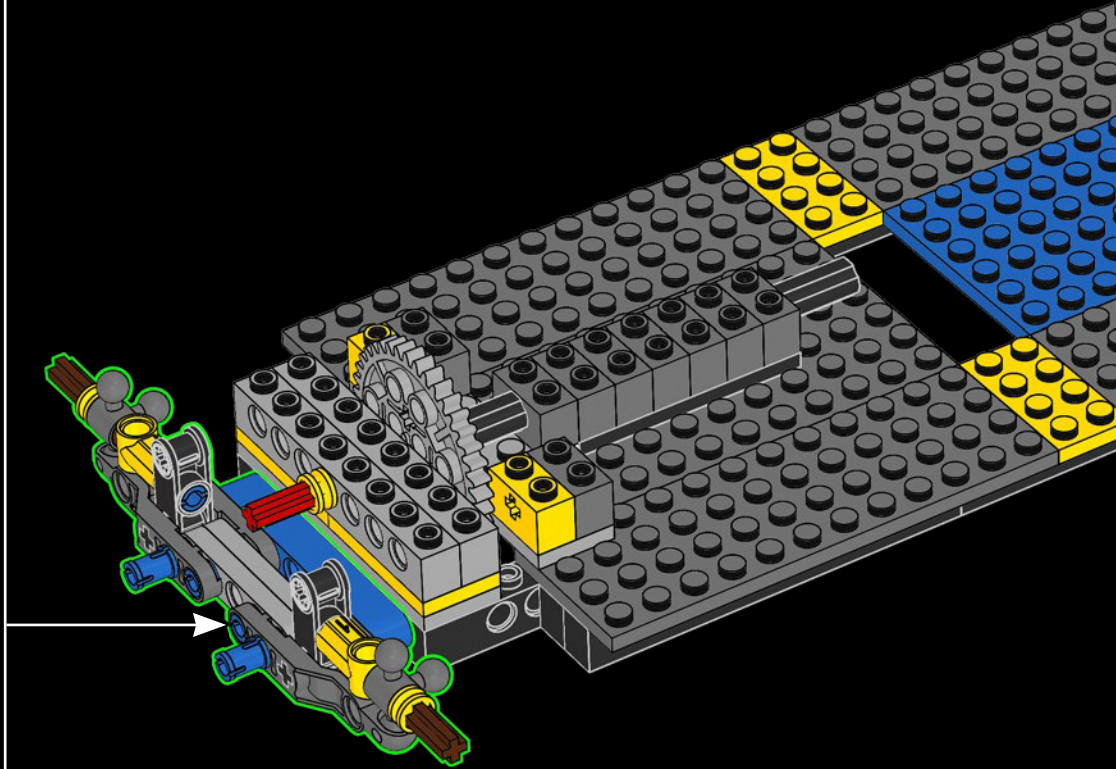

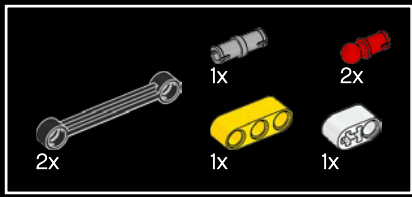

32

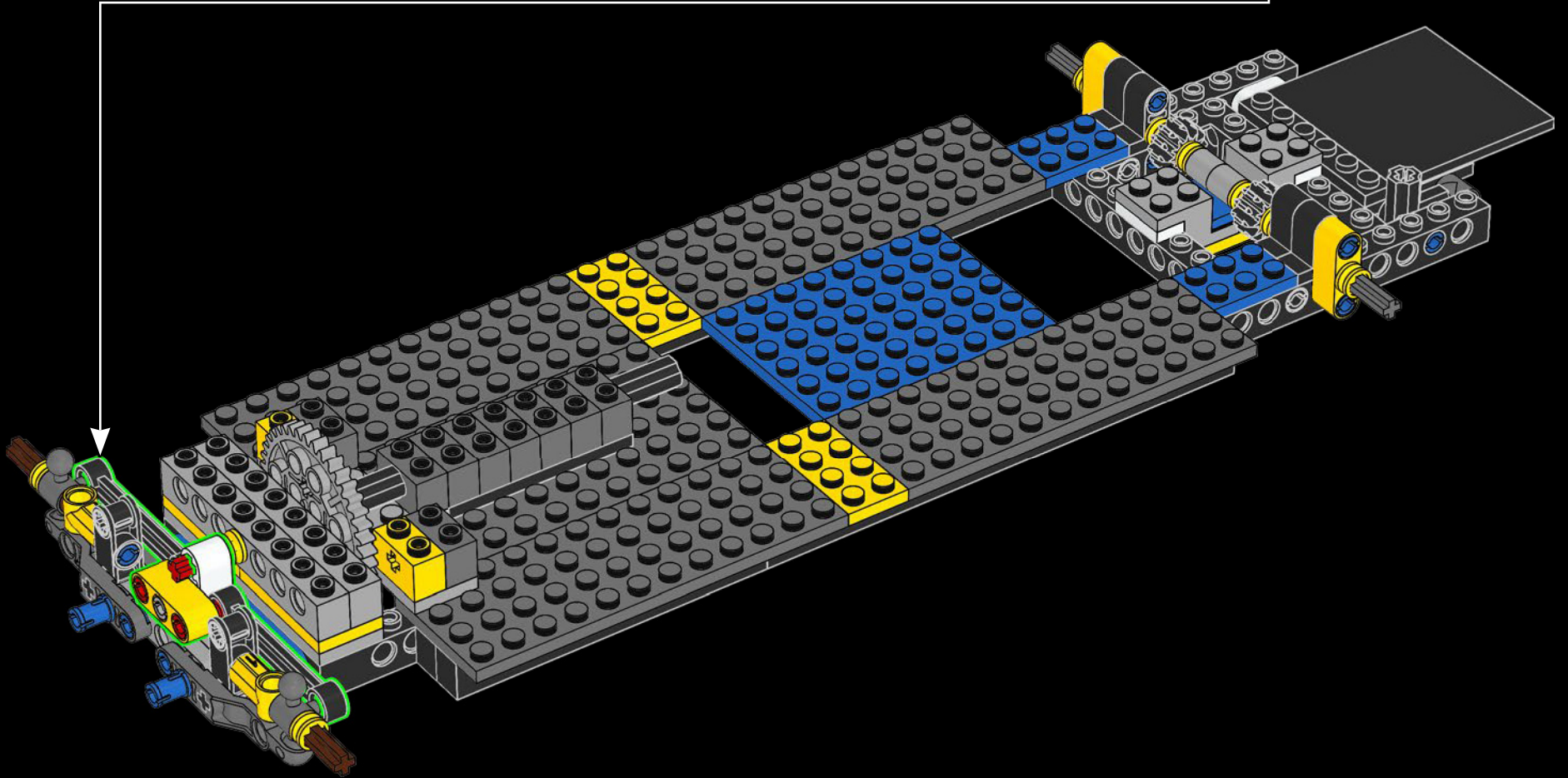
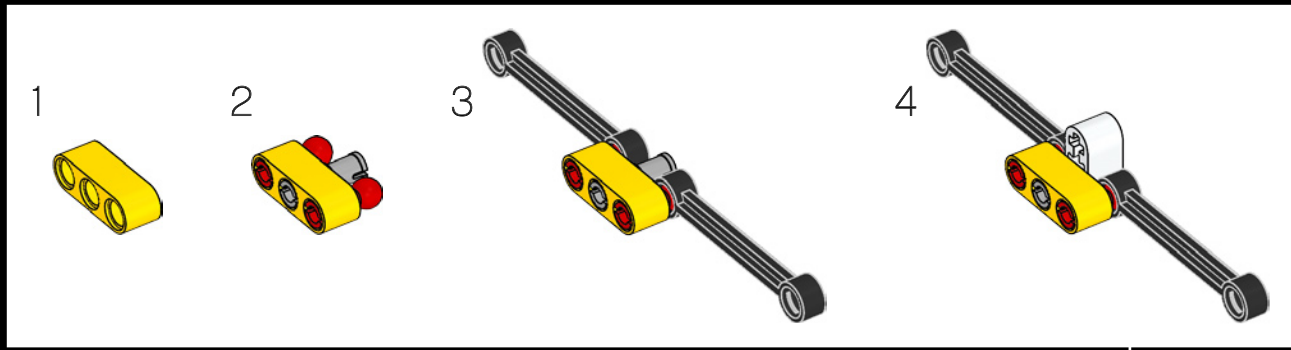

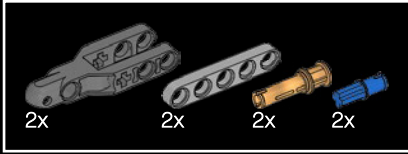
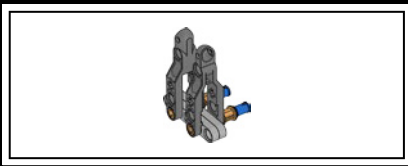

33

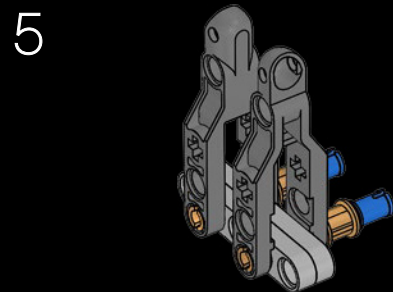
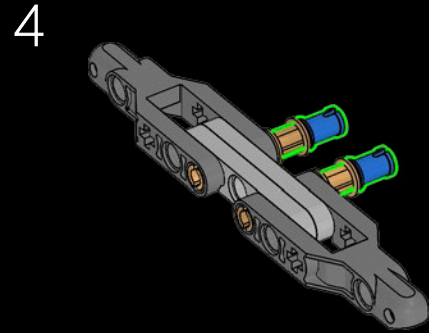
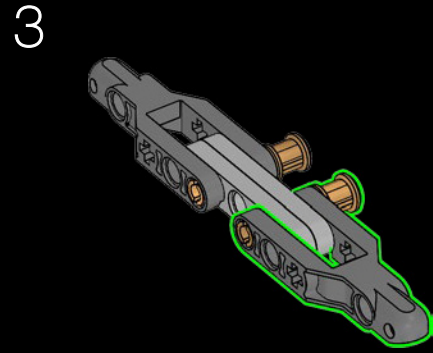
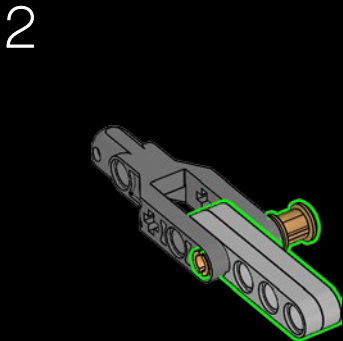
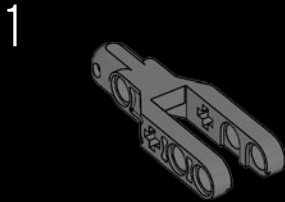
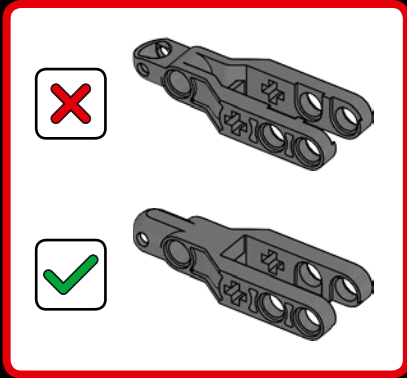

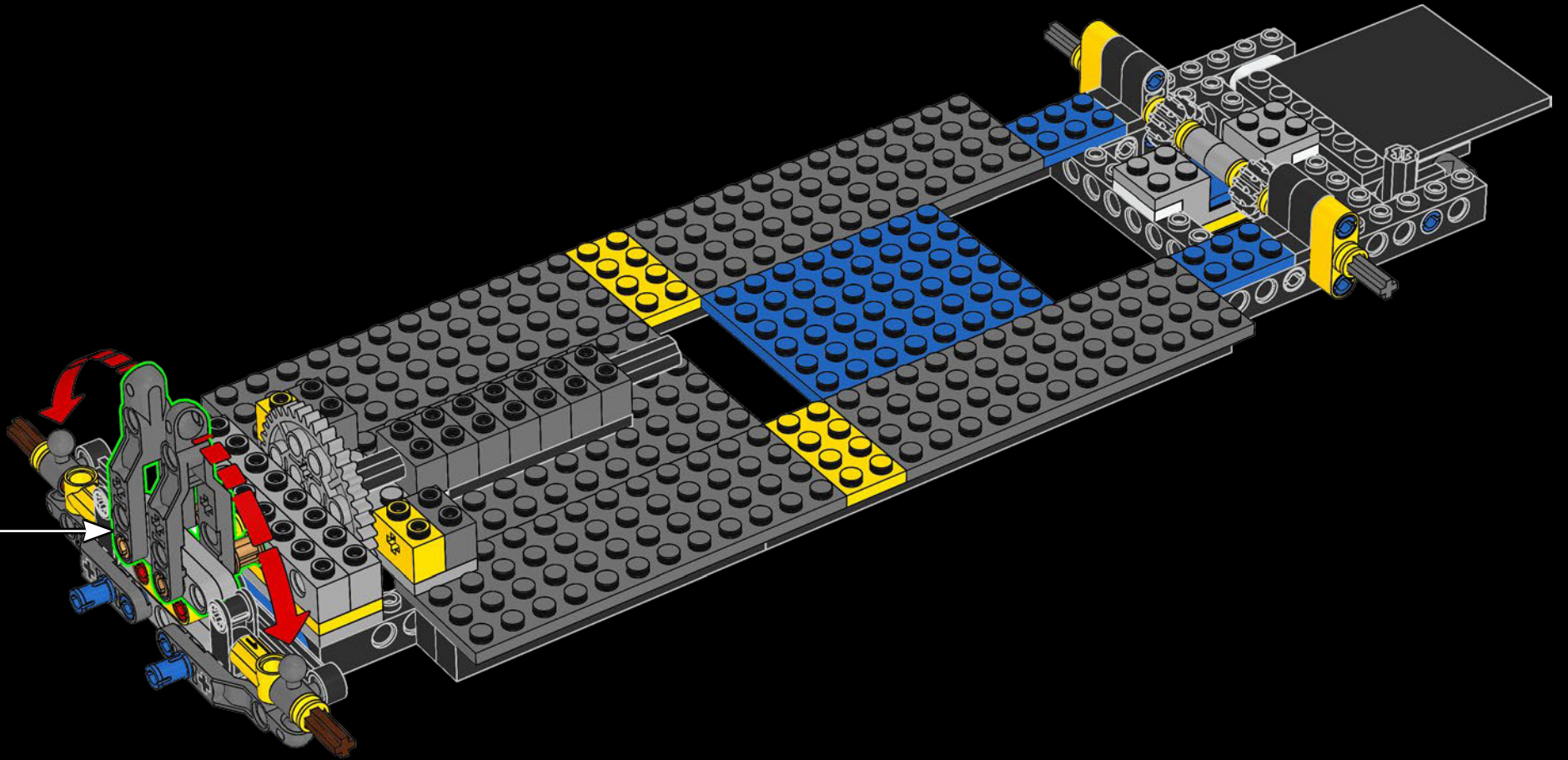

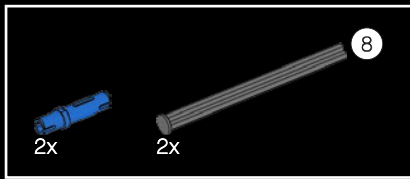

34

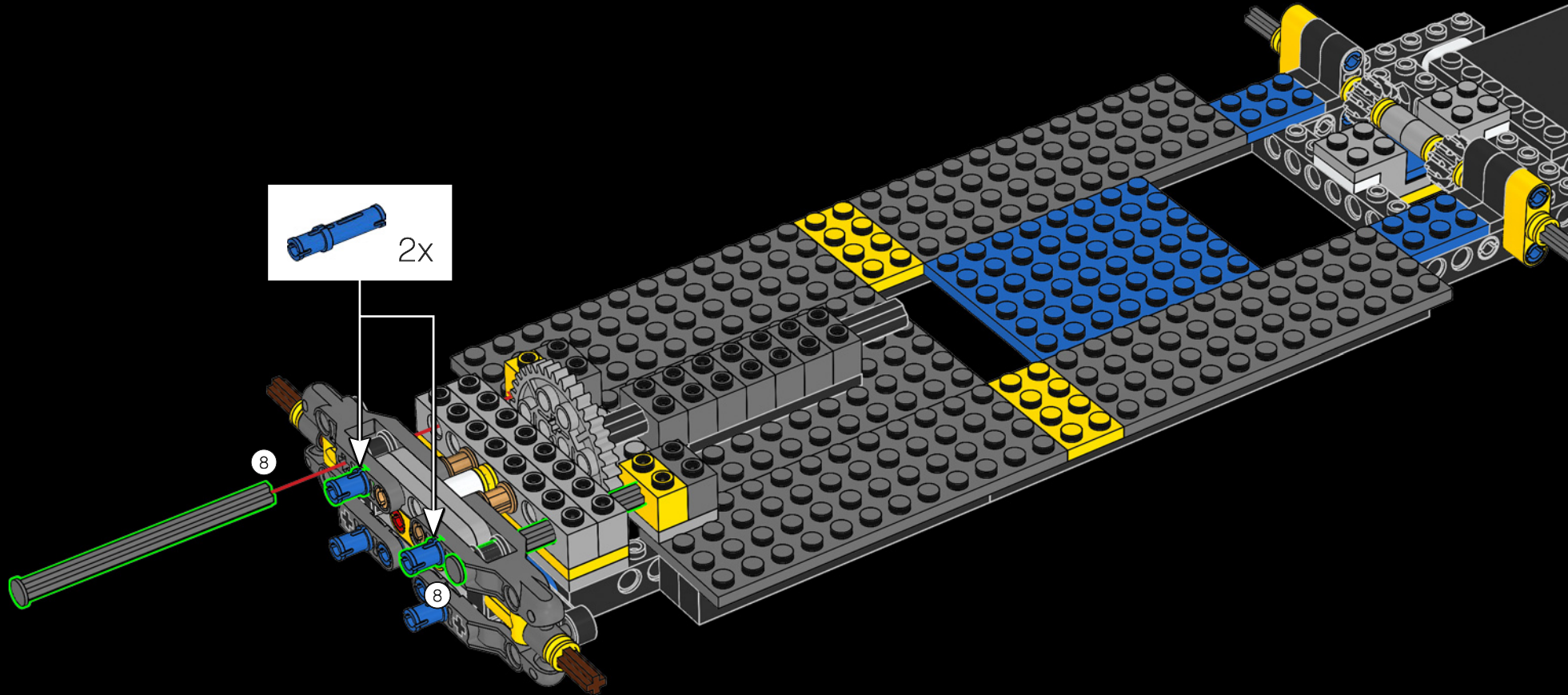

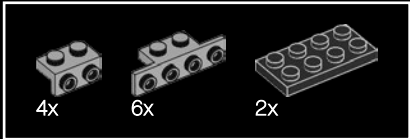
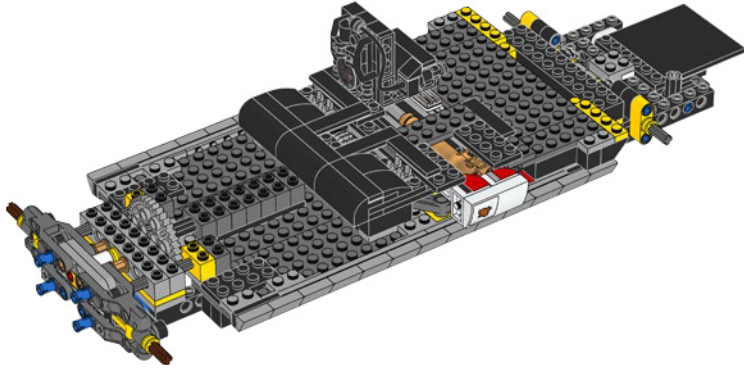
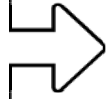
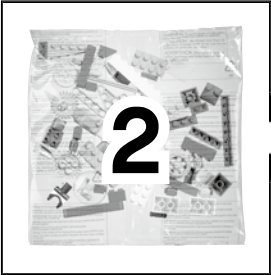

35

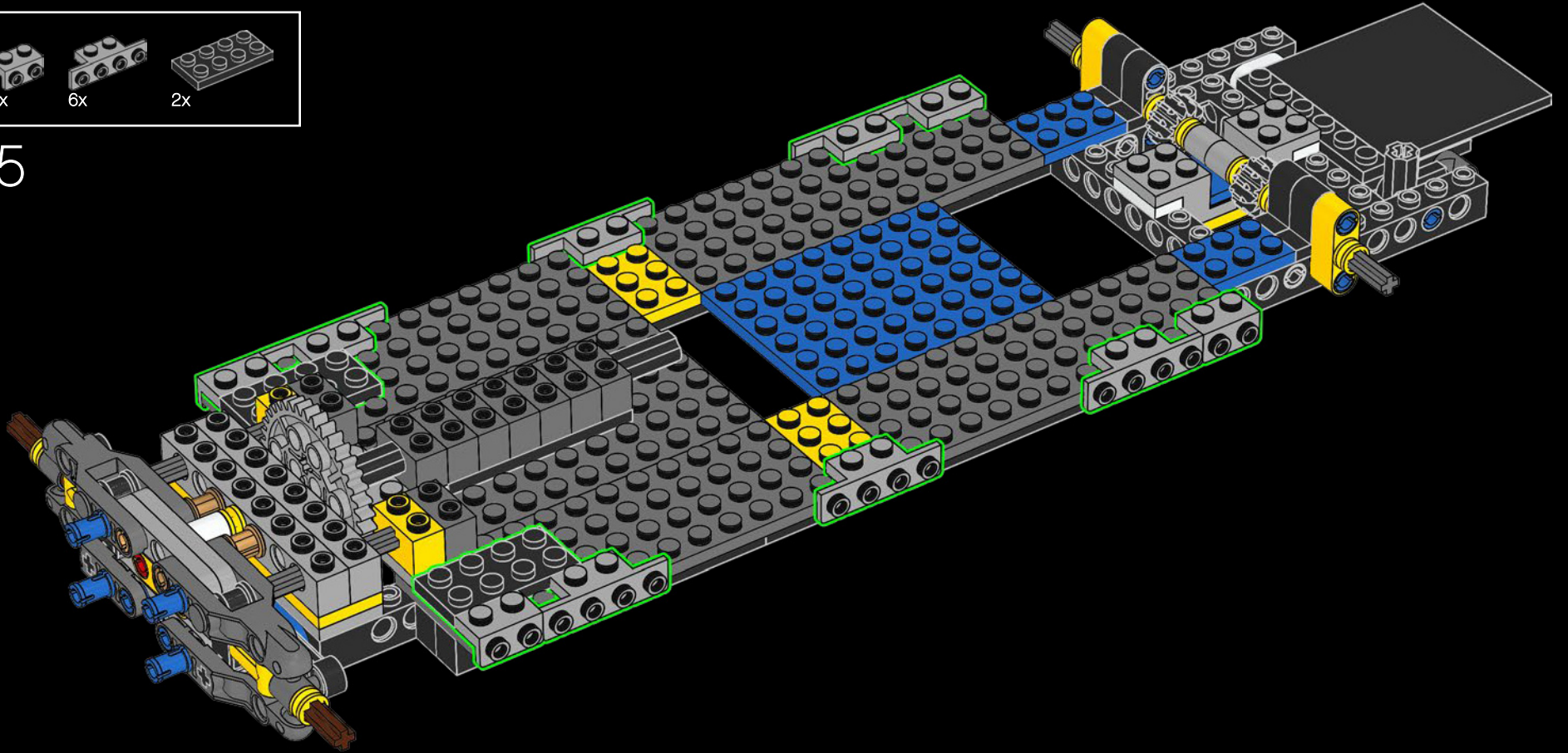



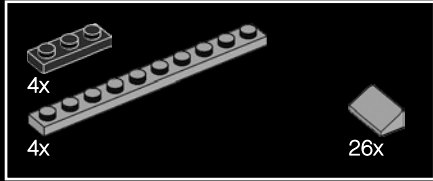
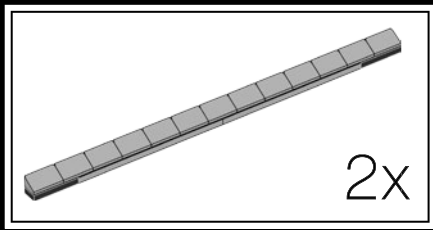

36

1

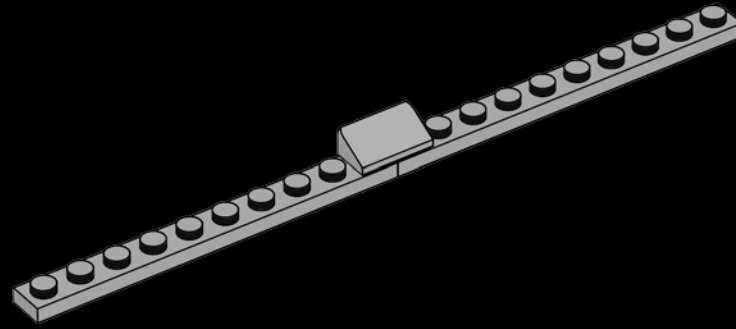

2

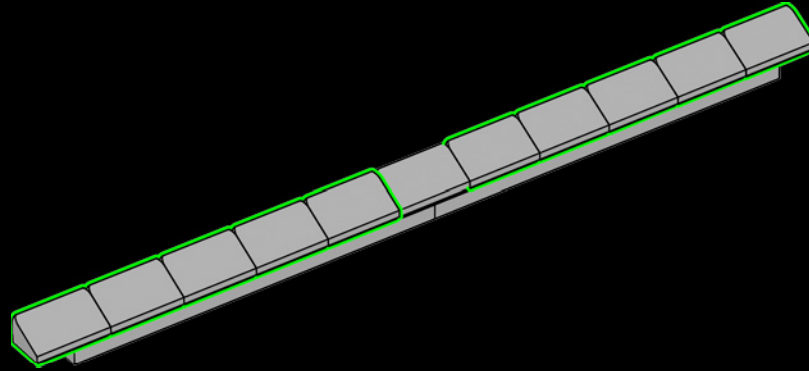

3

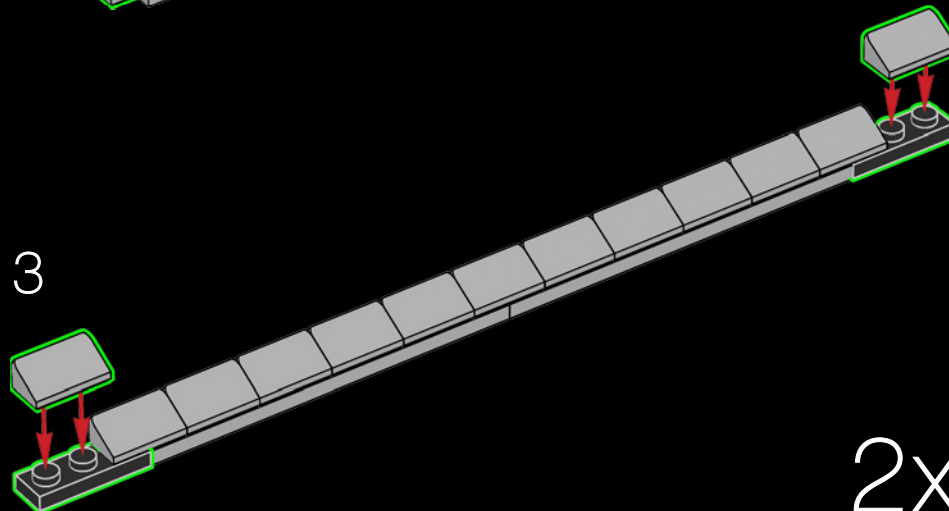

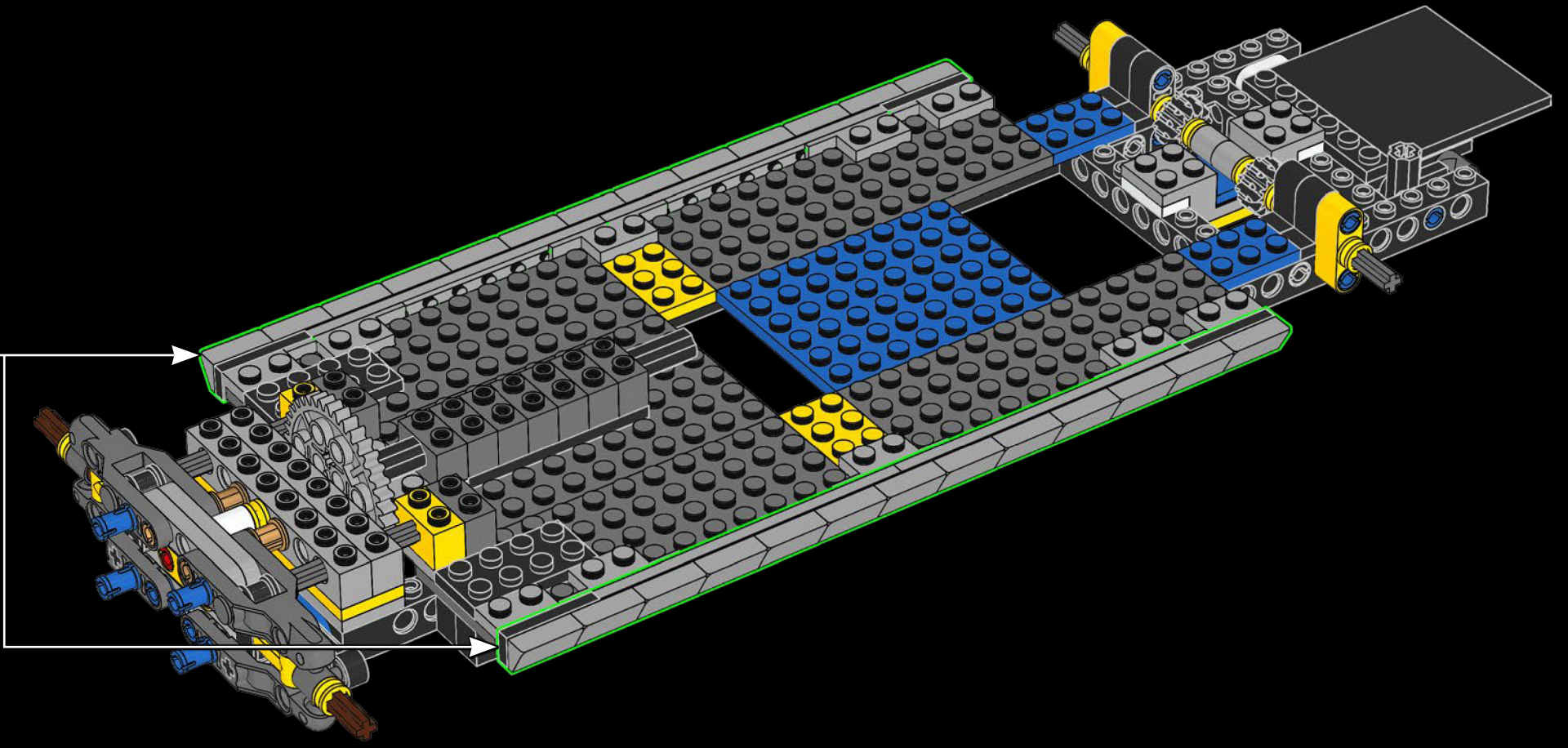

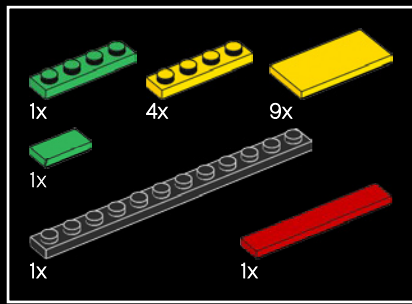

37

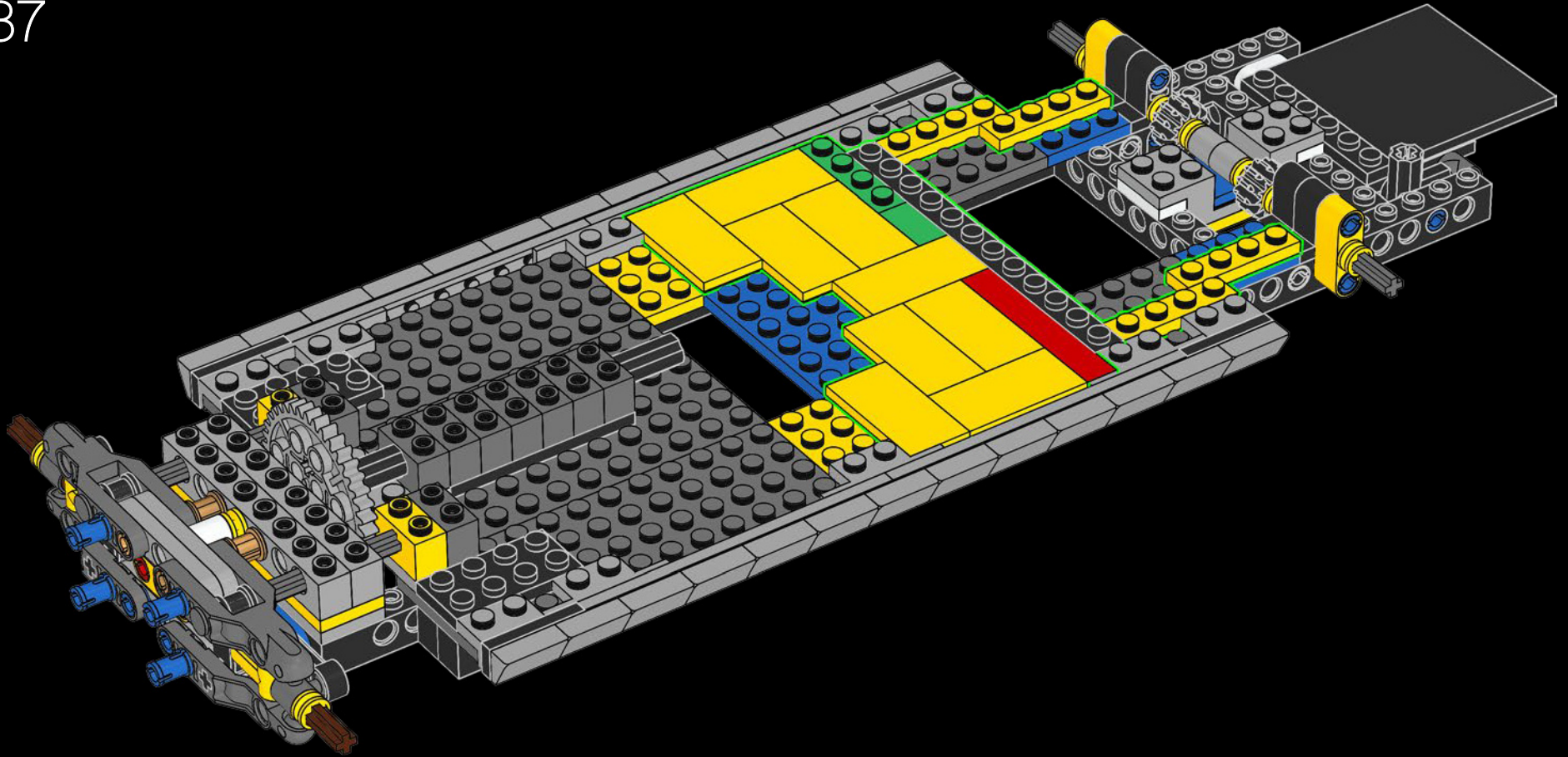

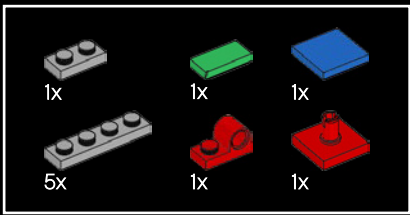

38

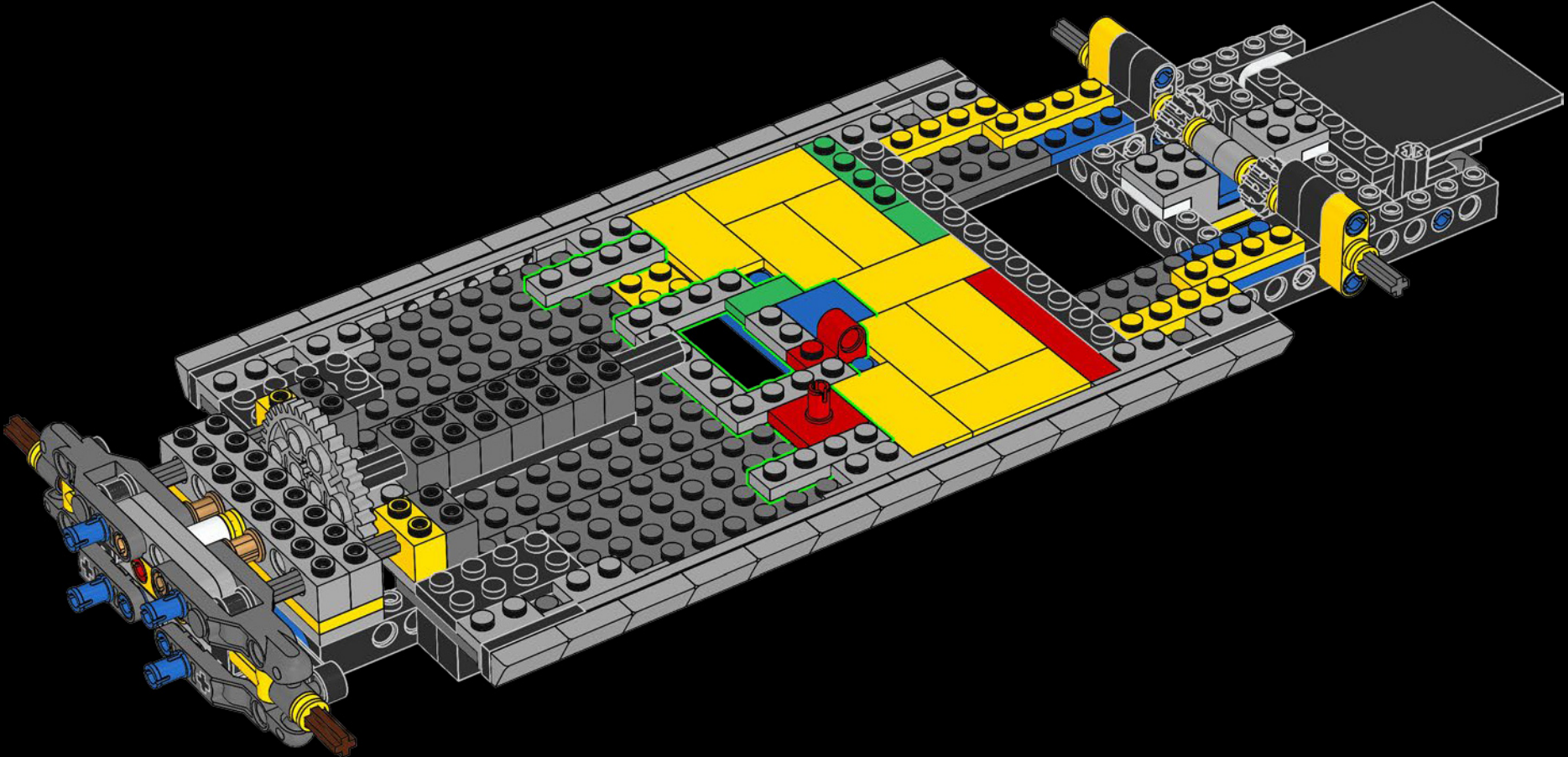

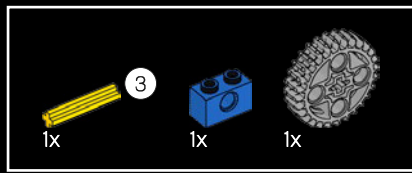

39

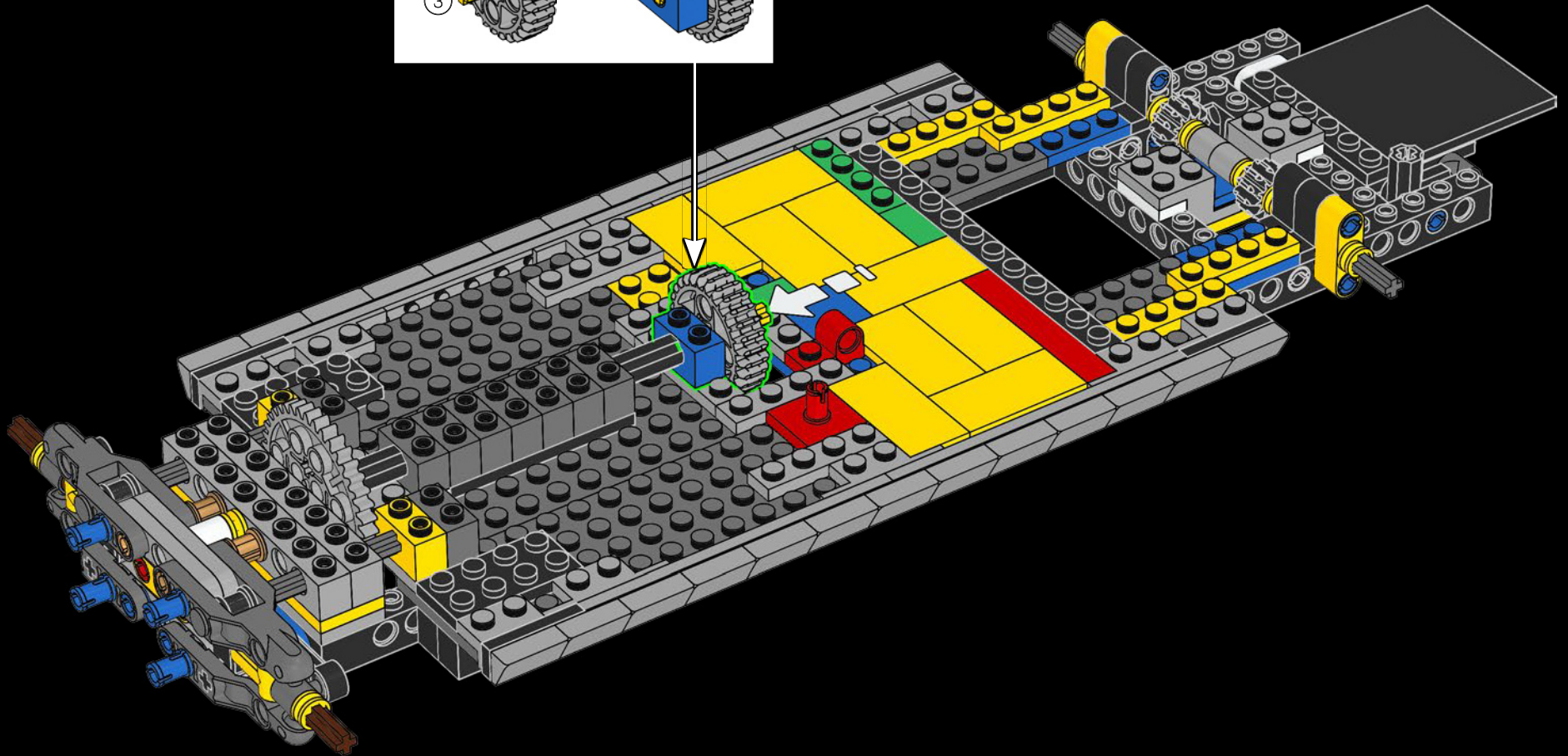
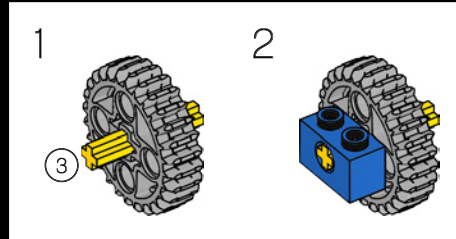

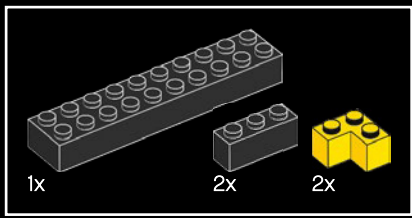

40

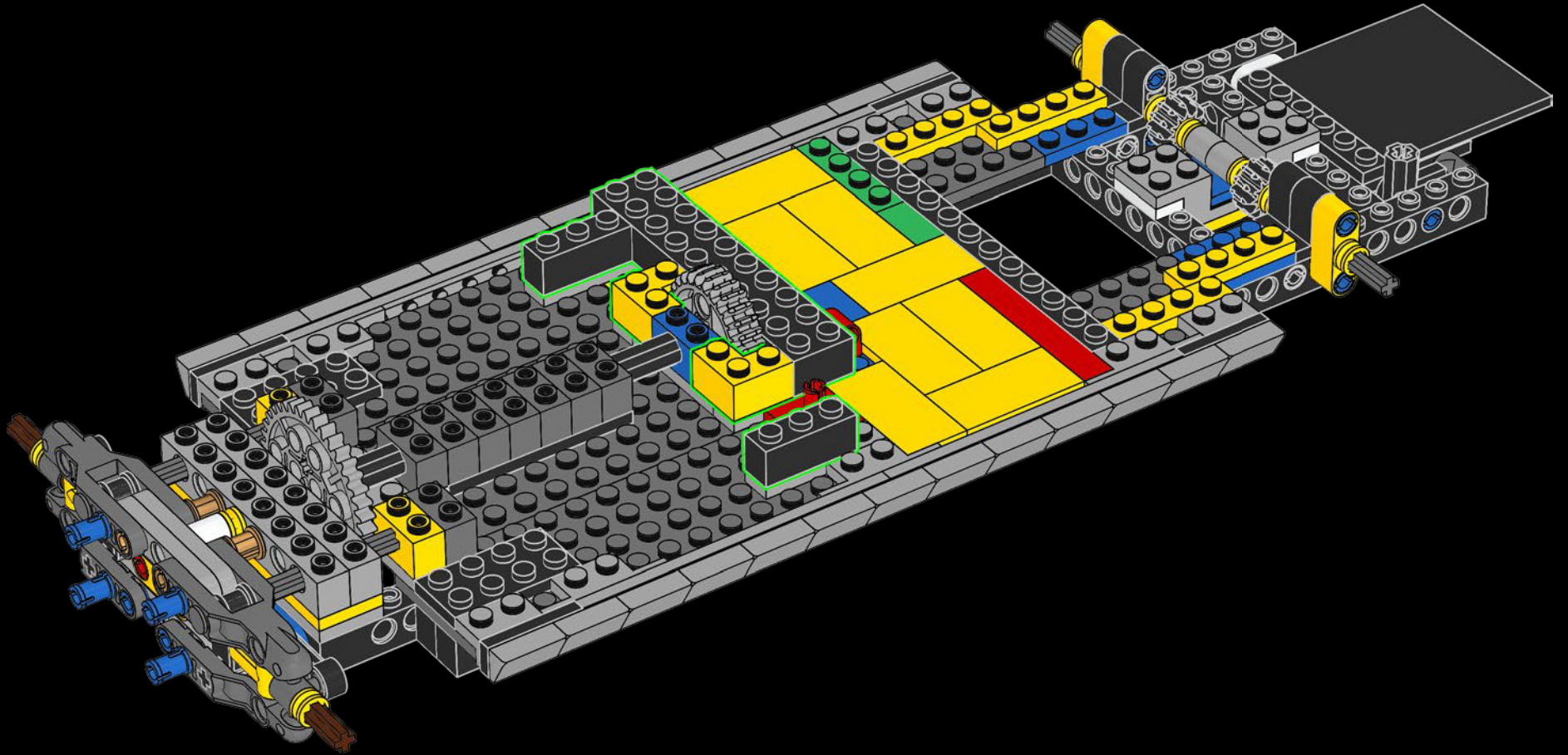

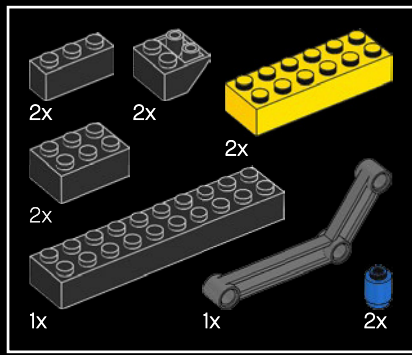

41

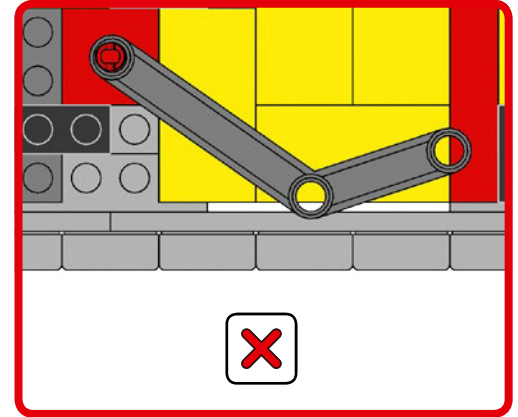
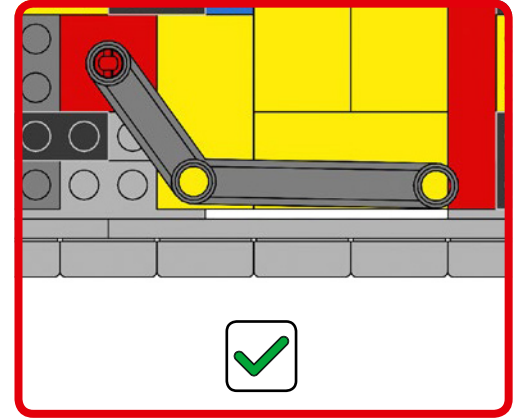
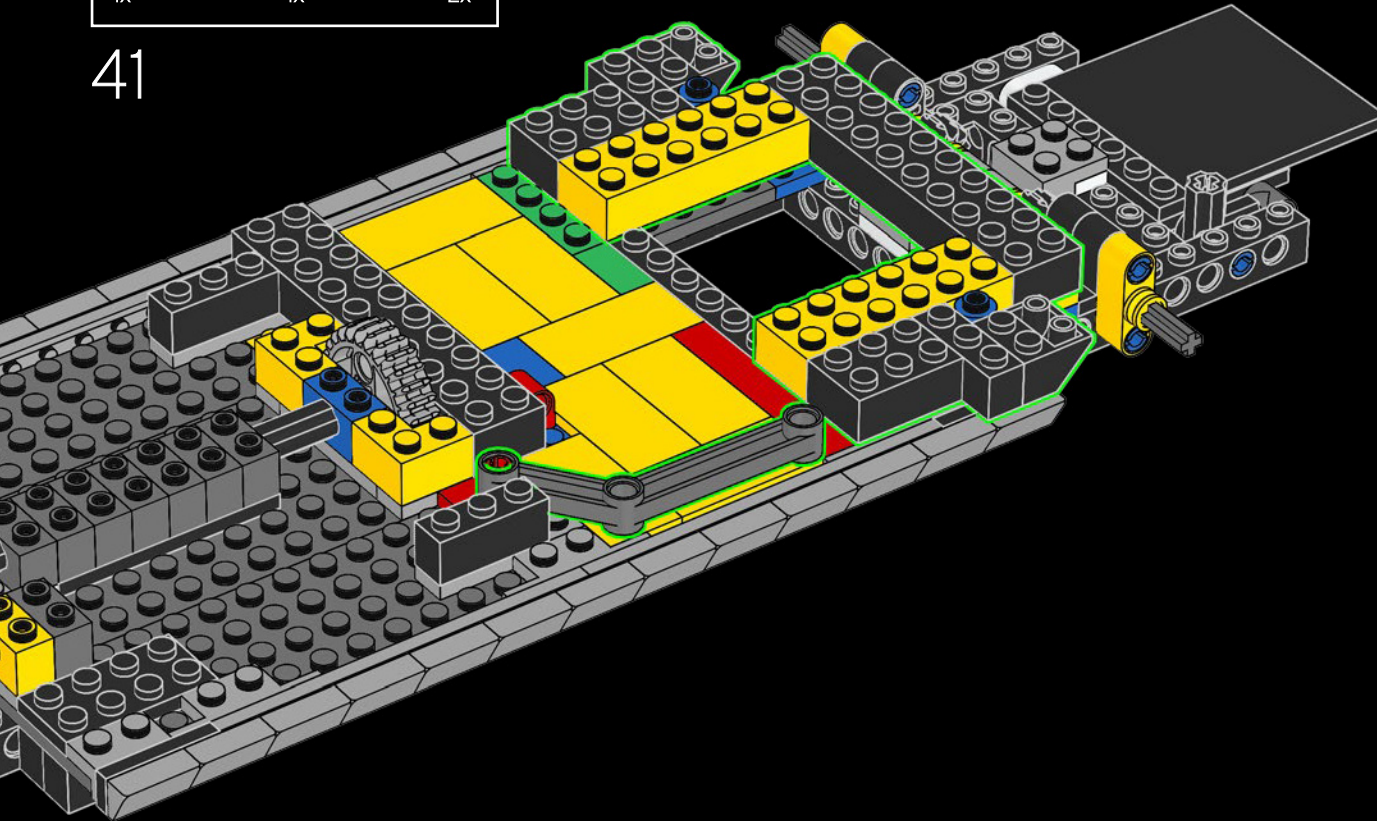

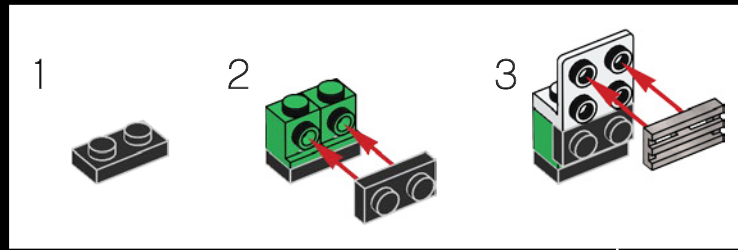
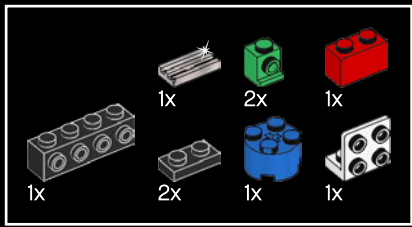

42

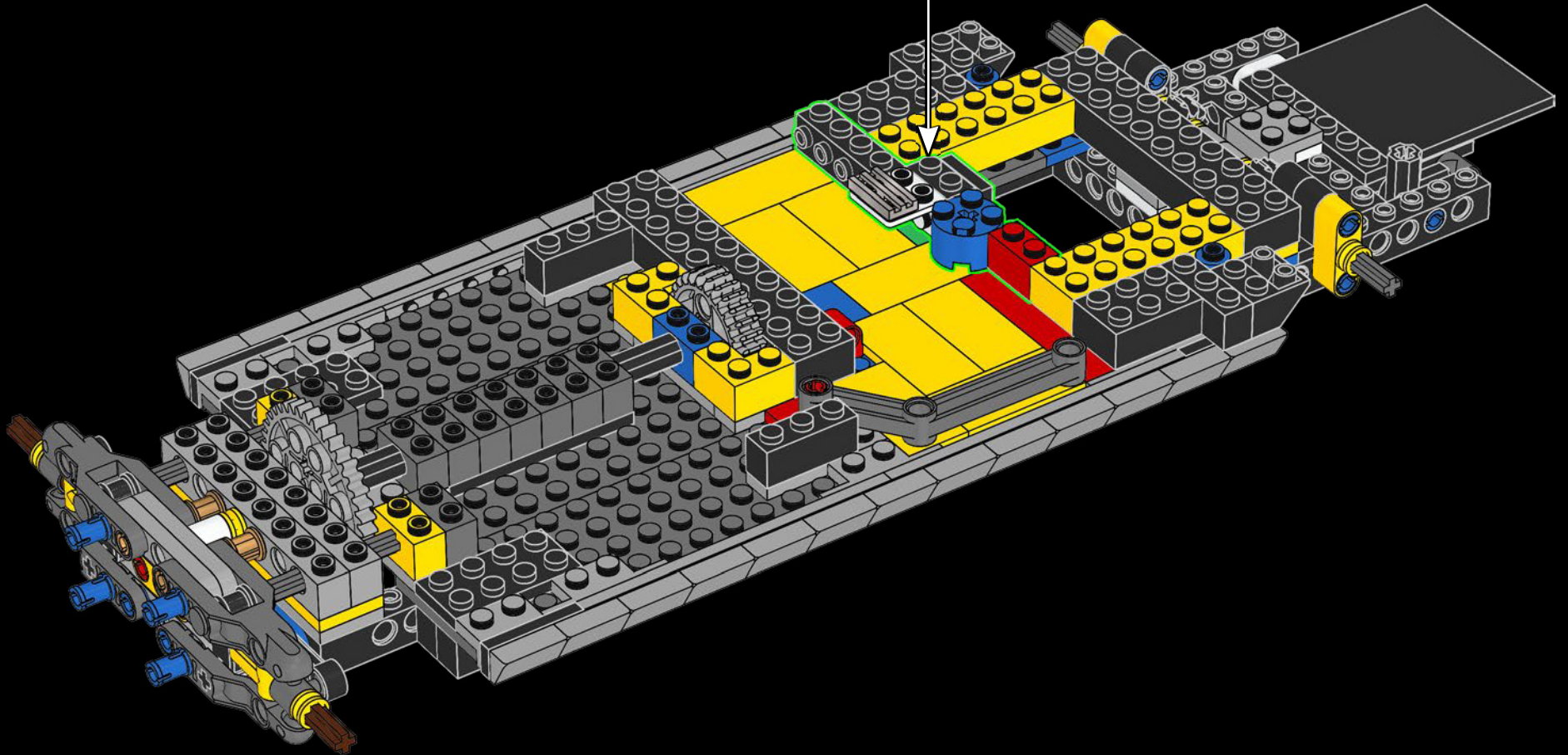



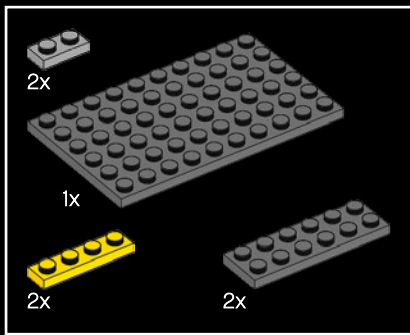

43

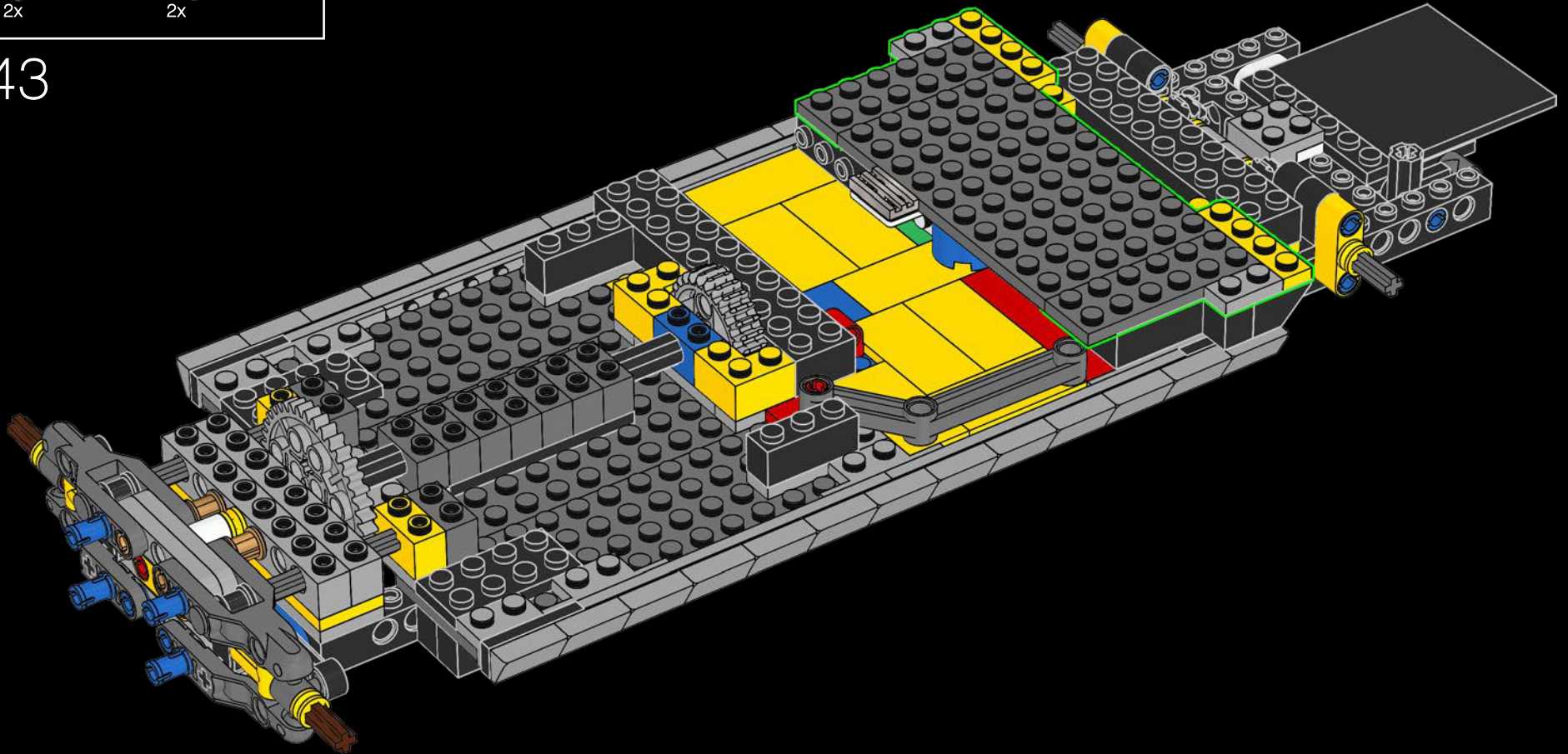

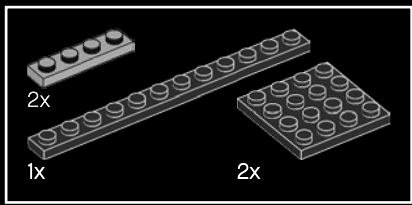

44

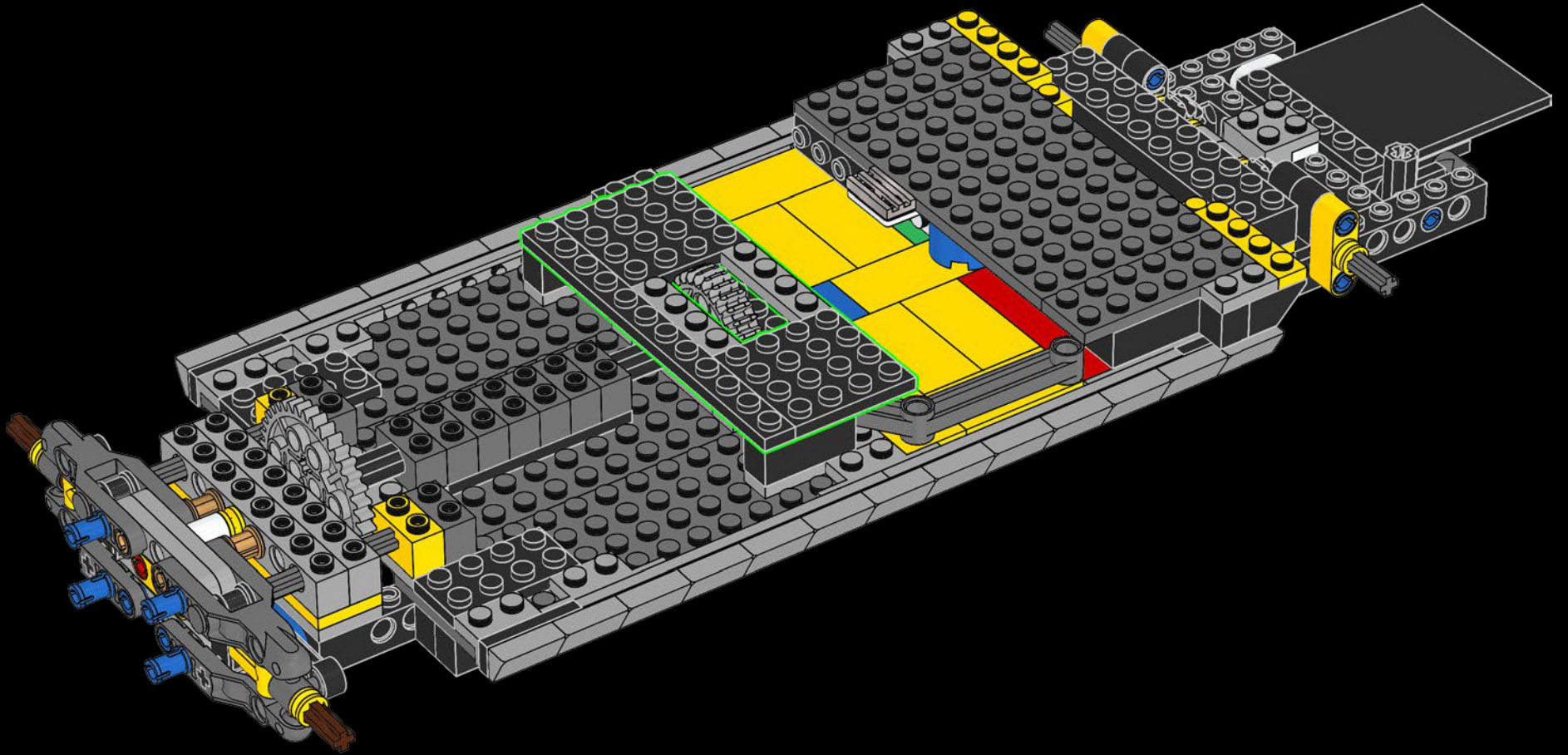

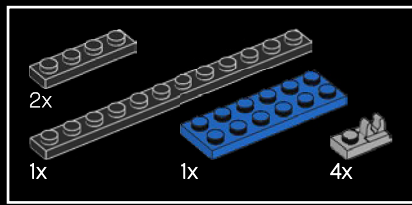

45

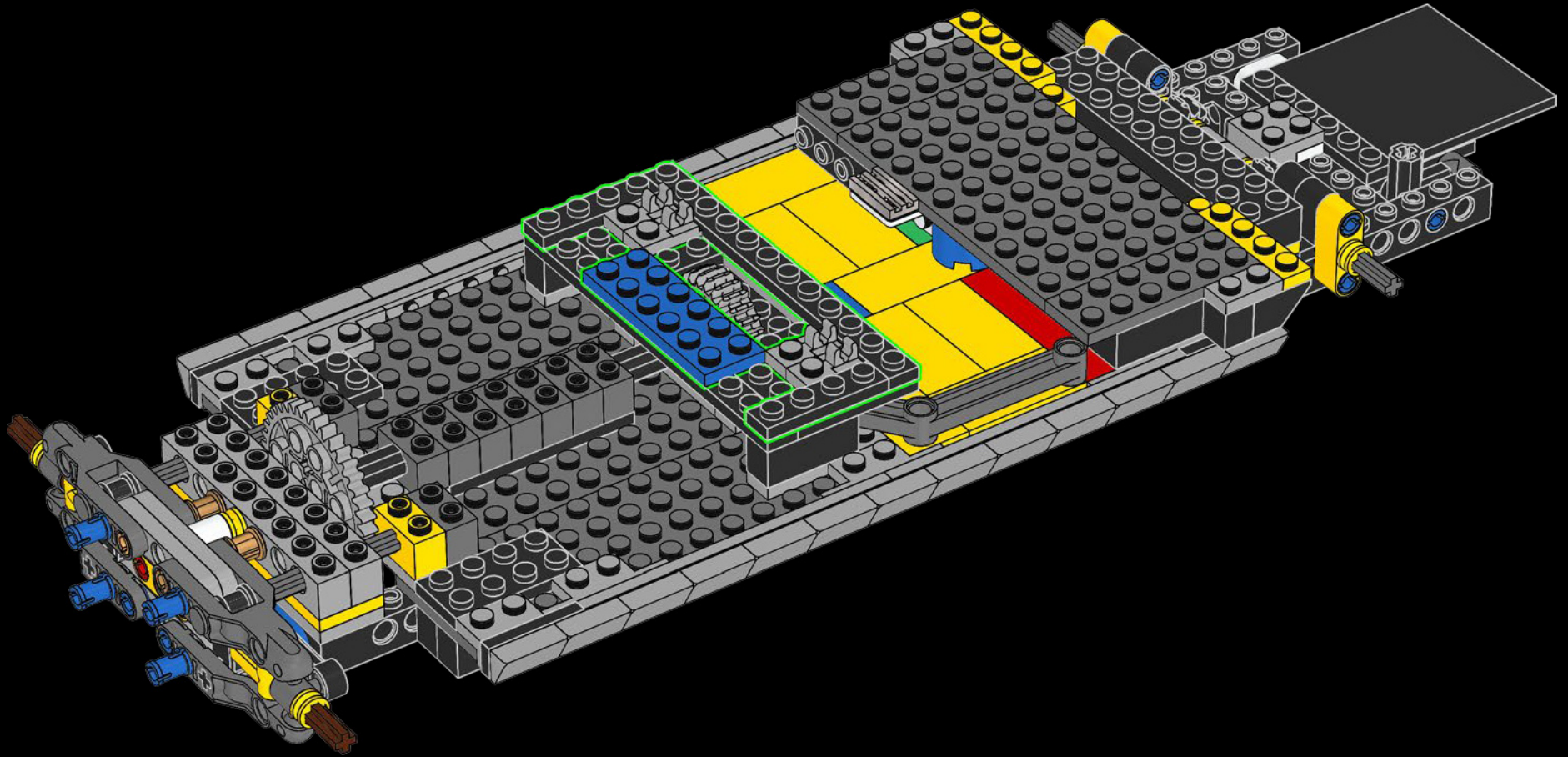

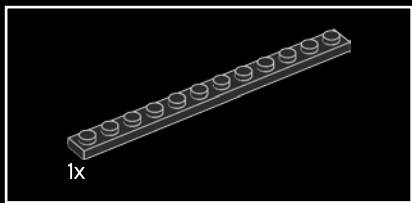

46

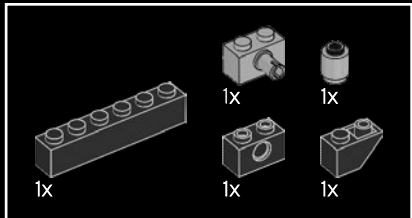
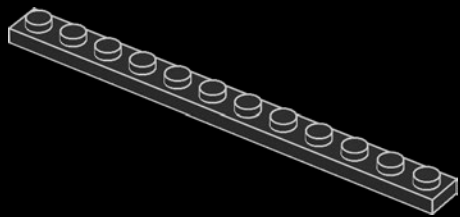

47

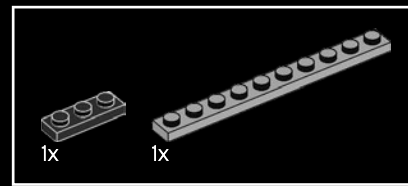
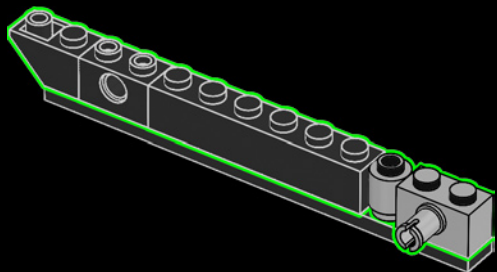

48

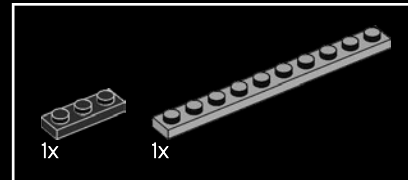
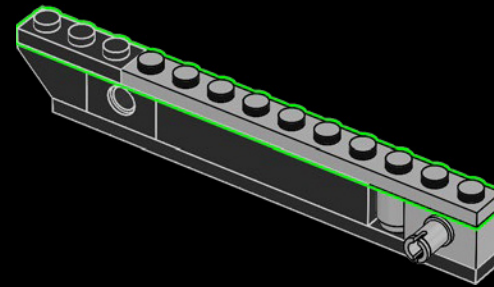

49

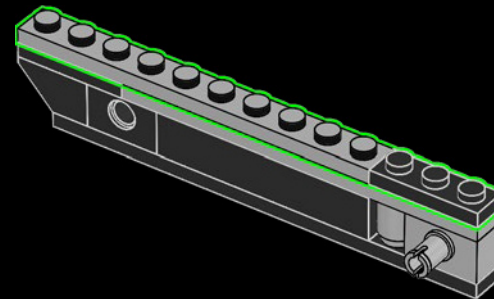

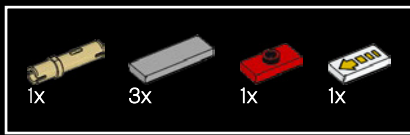

50

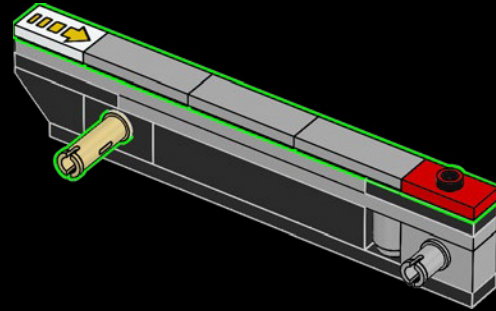

51

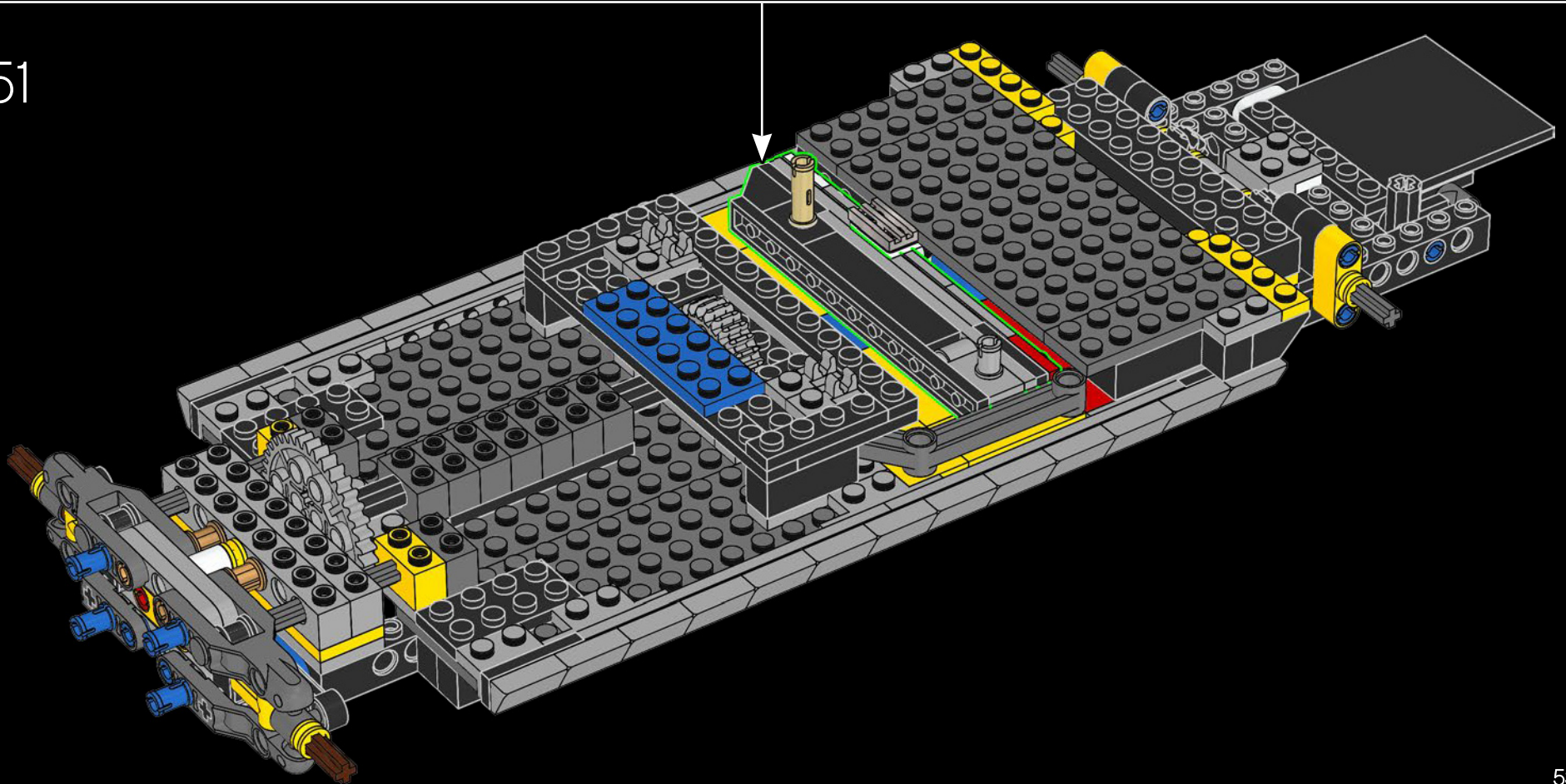

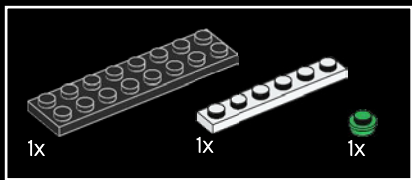

52

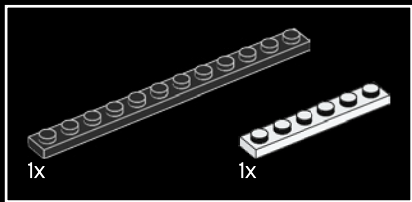
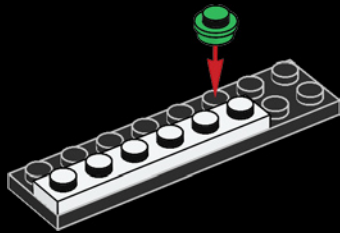

53

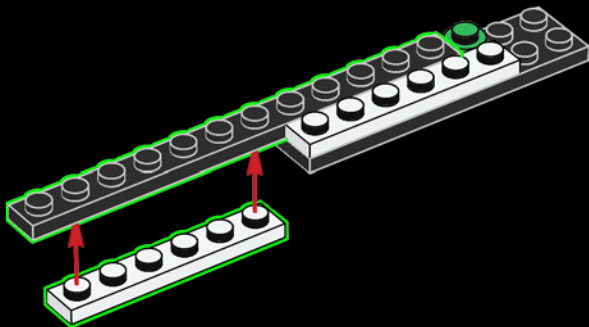

54



54

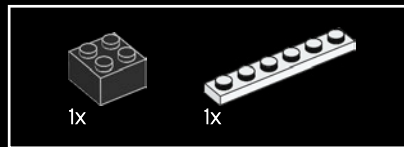
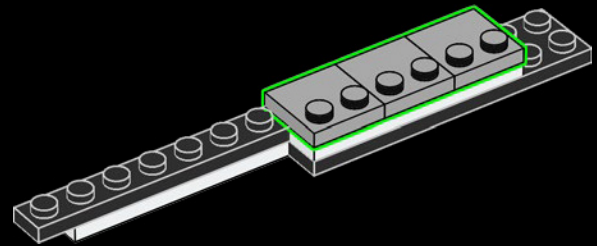

55

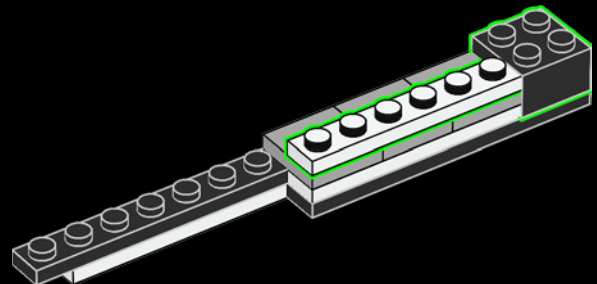

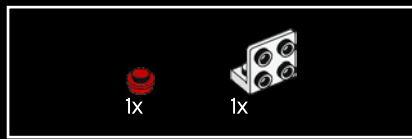

56

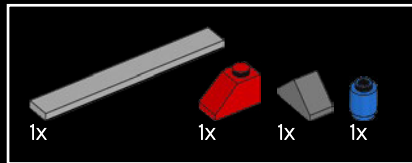
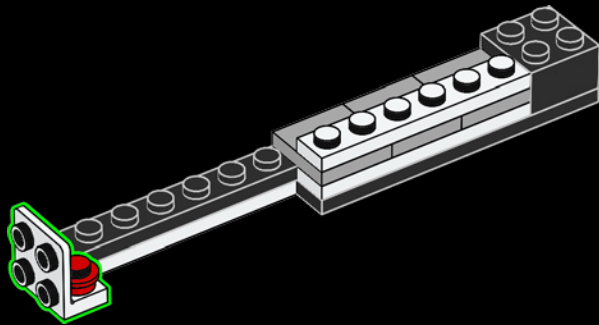

57

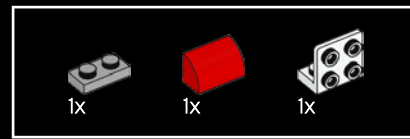
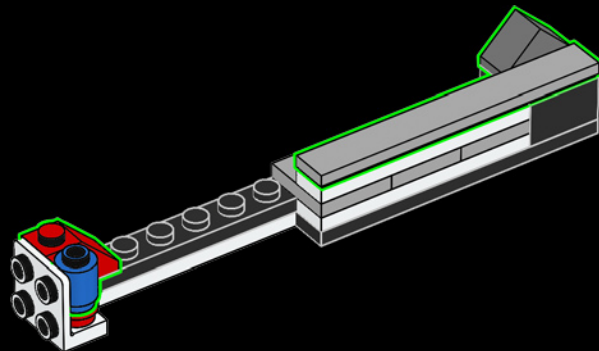

58

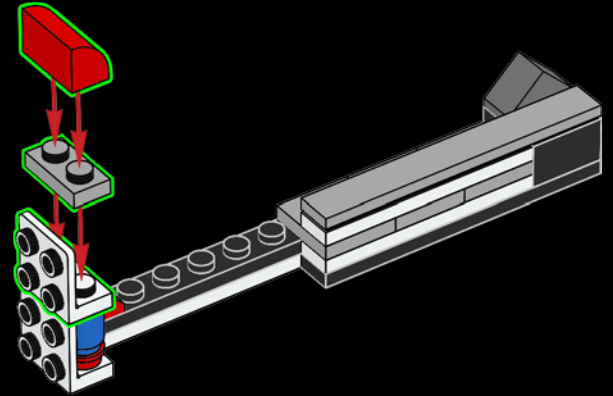

59

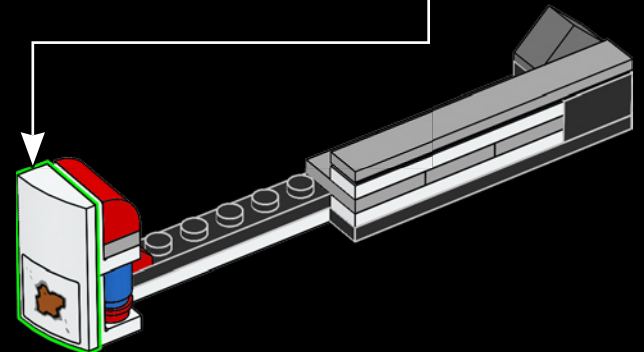
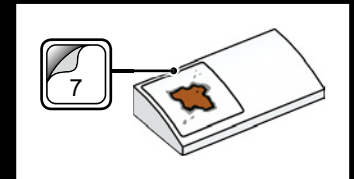

60

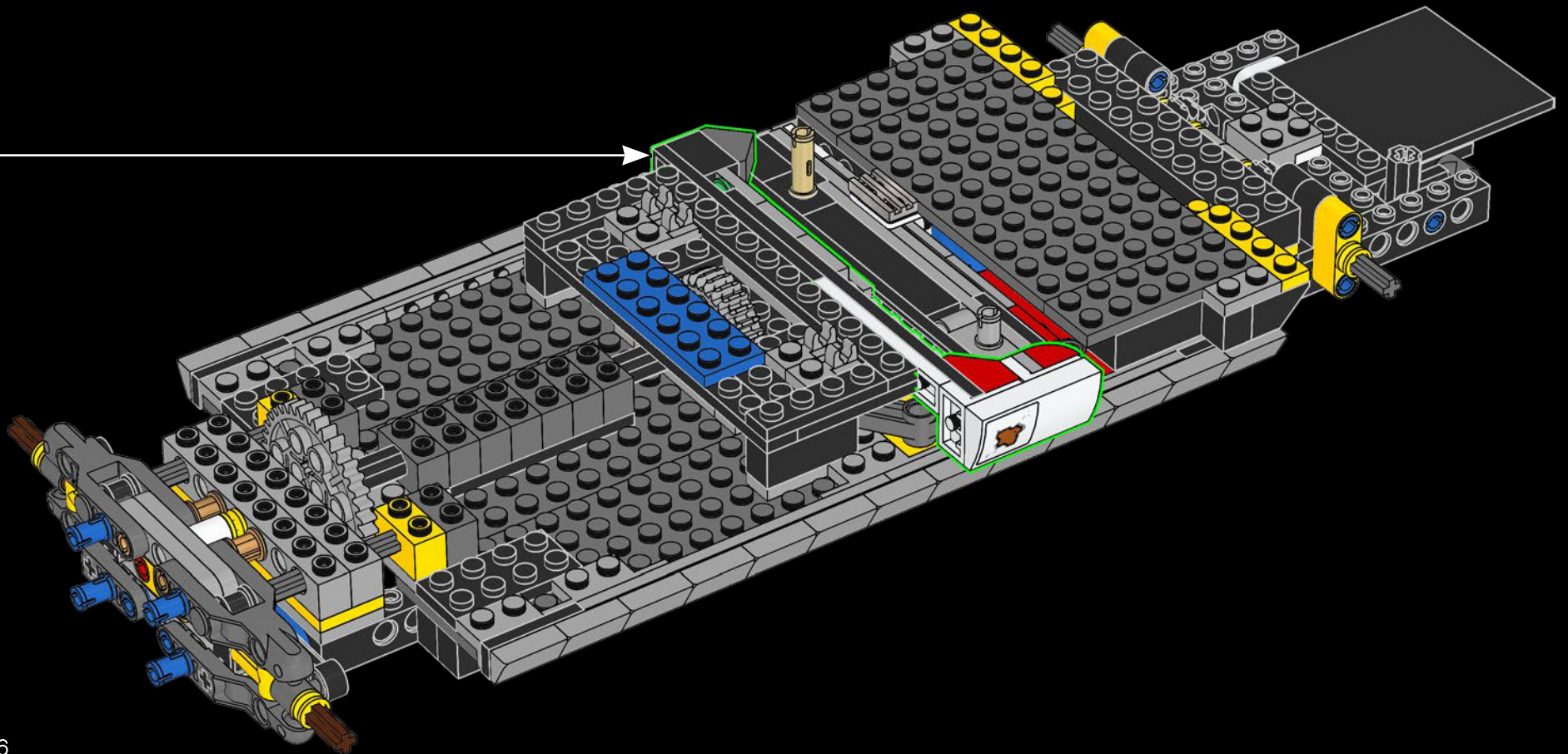



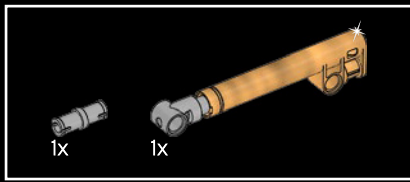

61

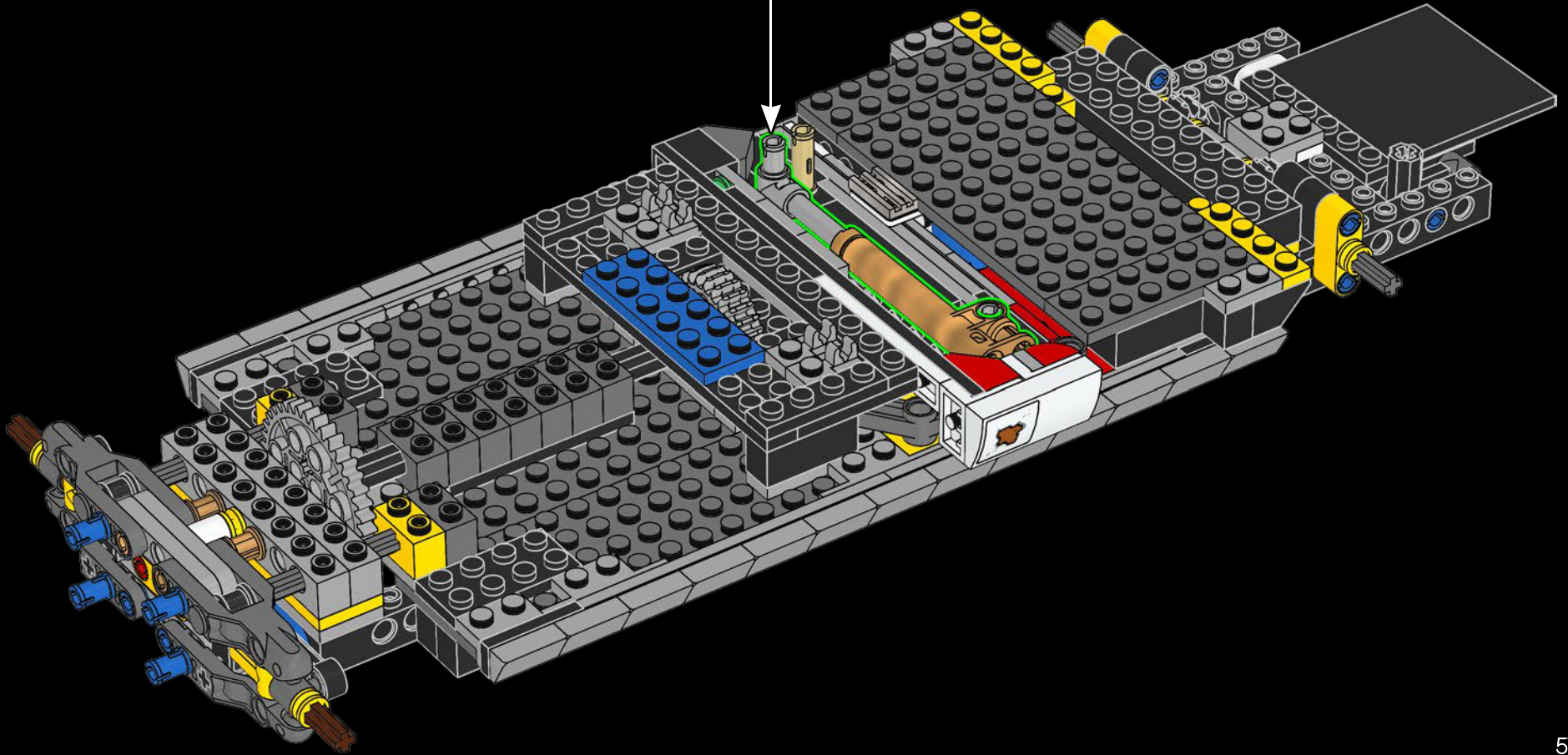
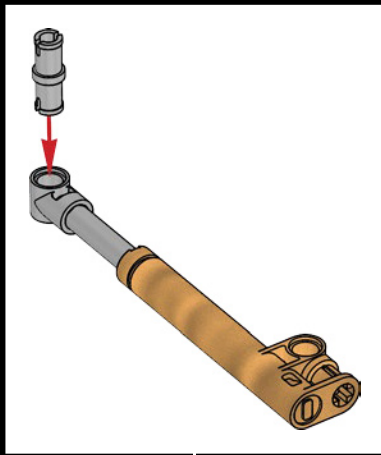

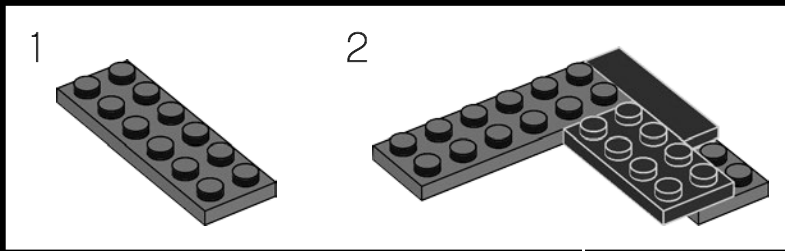
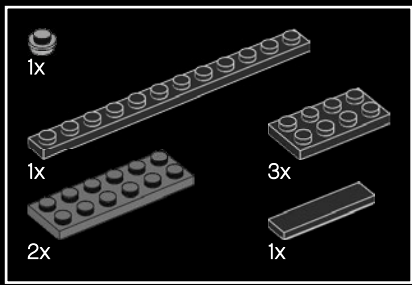

62

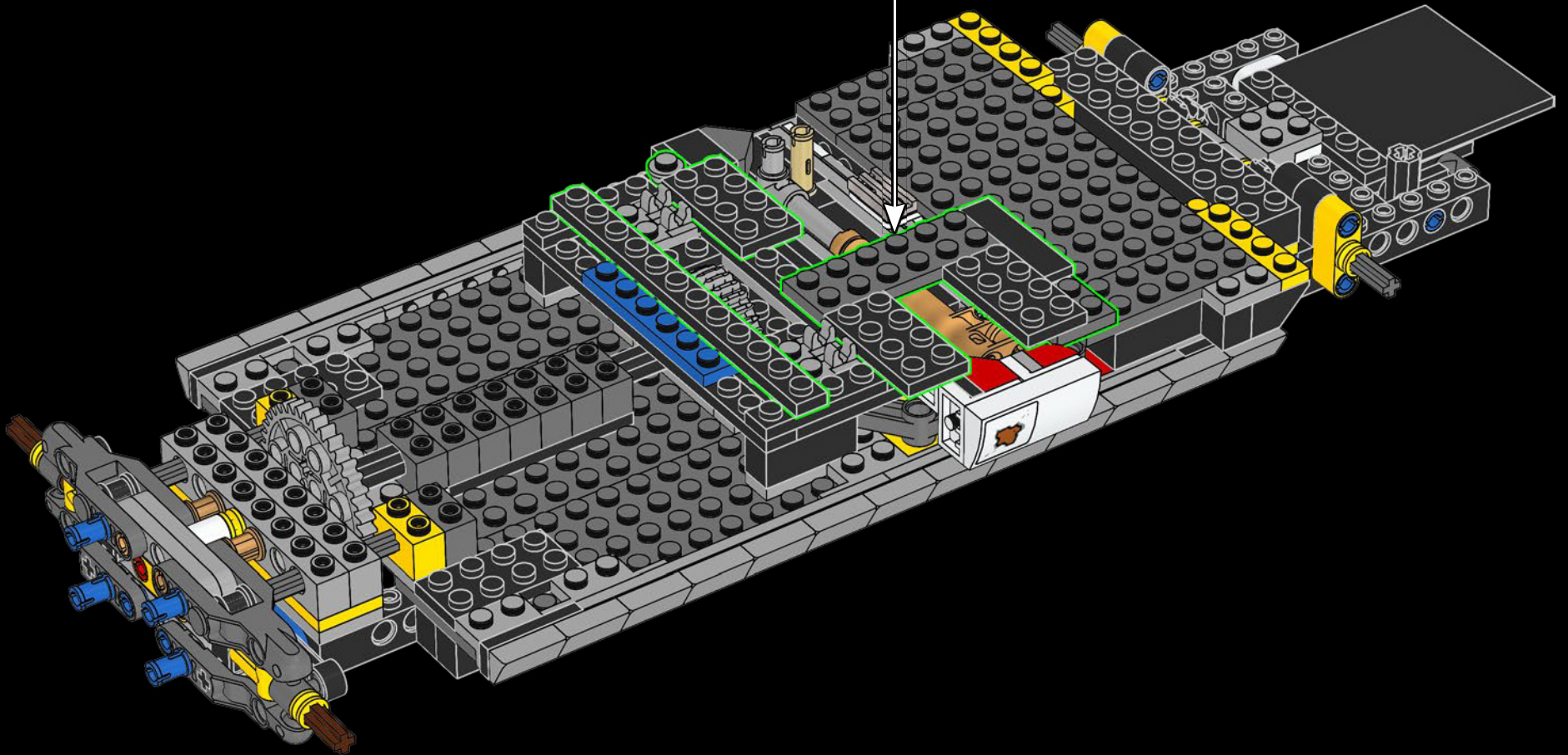

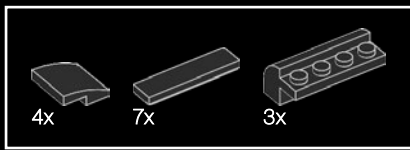

63

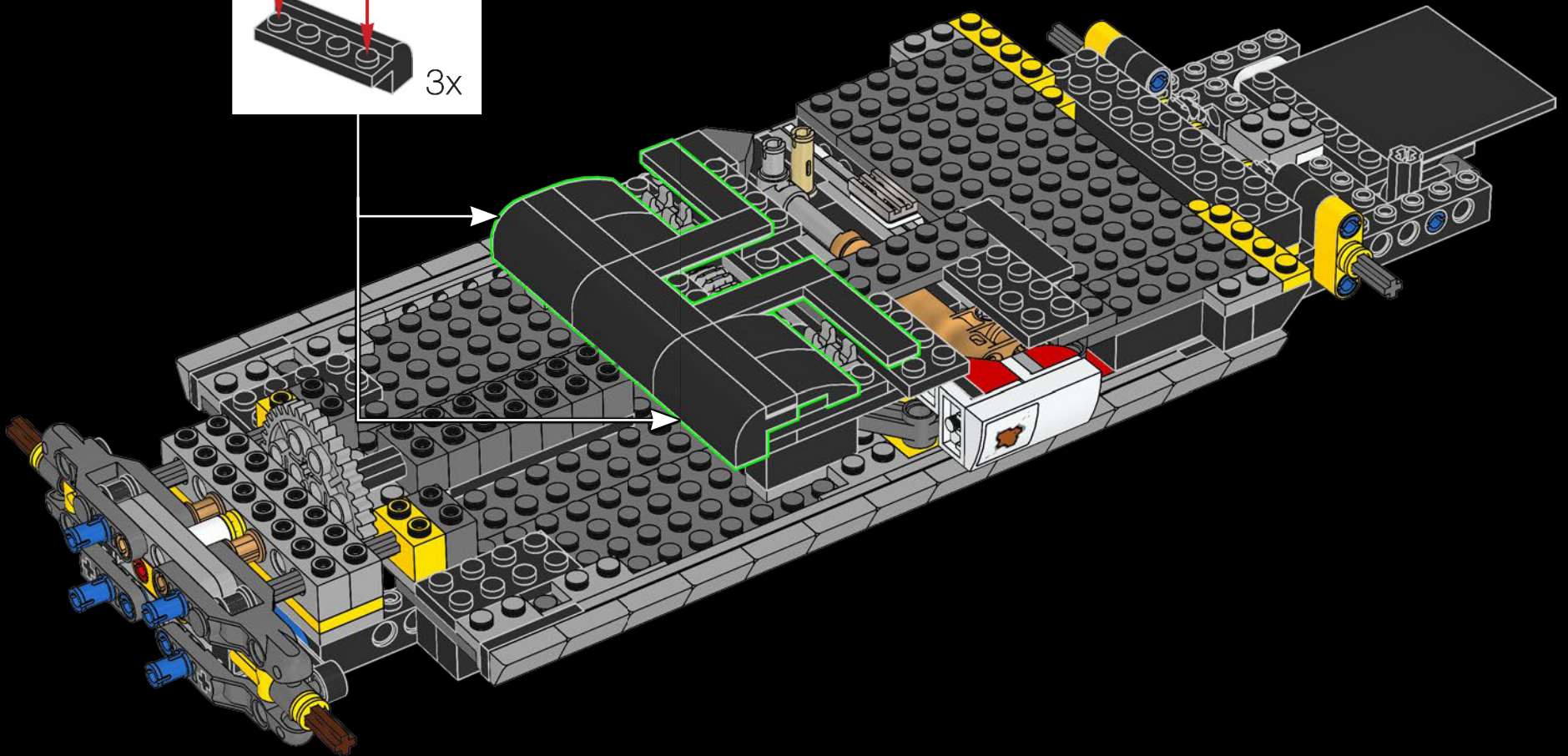
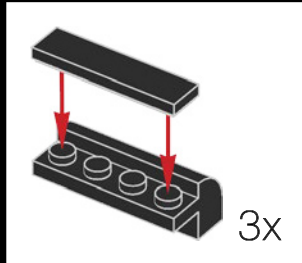

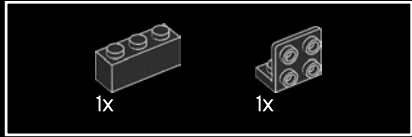
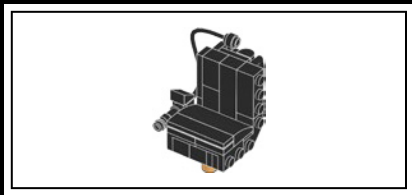

64

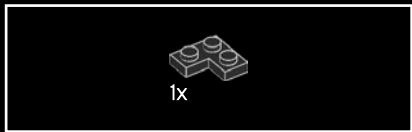
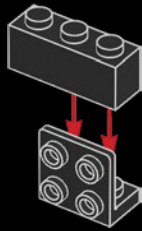

65

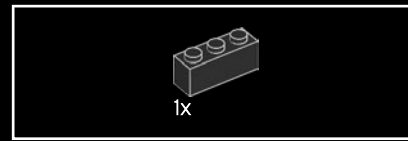
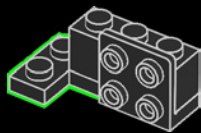

66

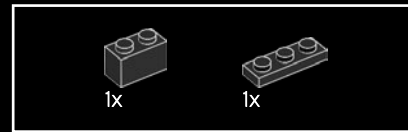
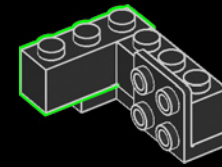

67

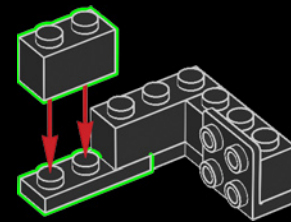

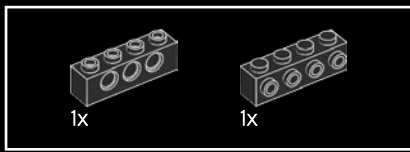

68

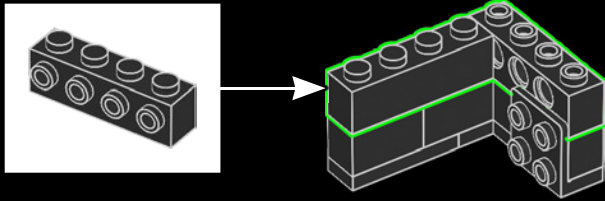

69

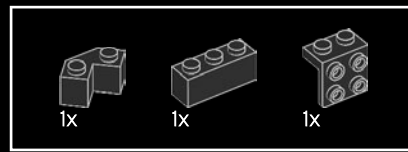
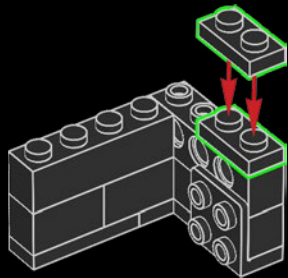

70

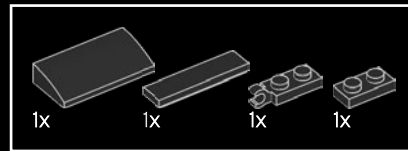
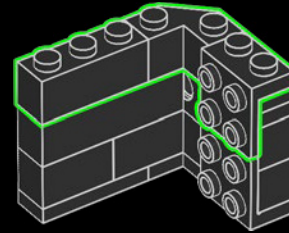

71

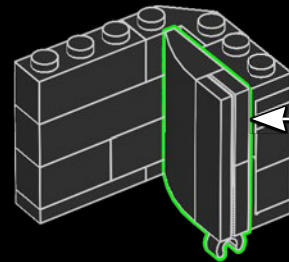
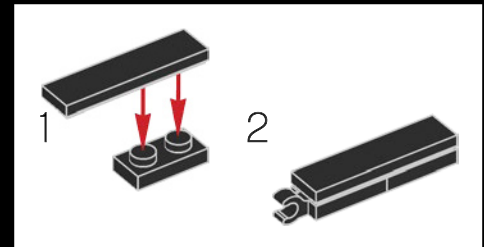

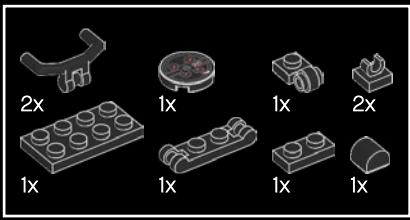

72

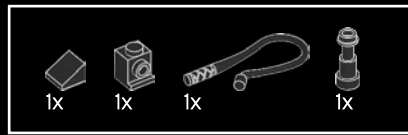
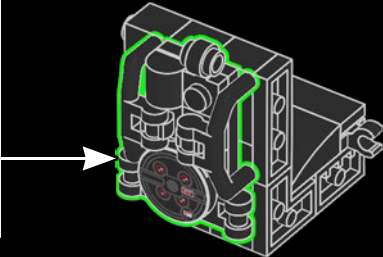
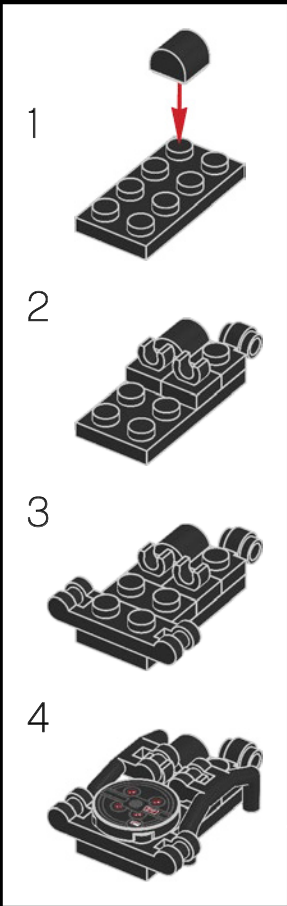

73

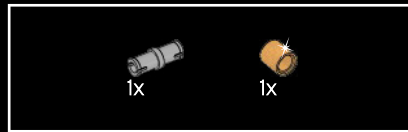
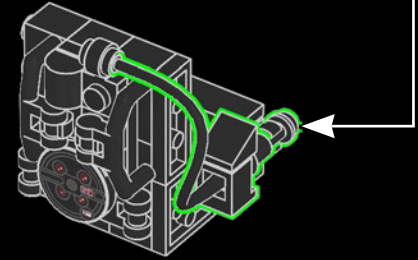
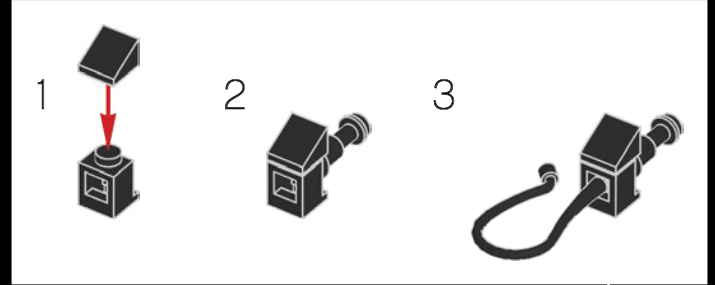

74

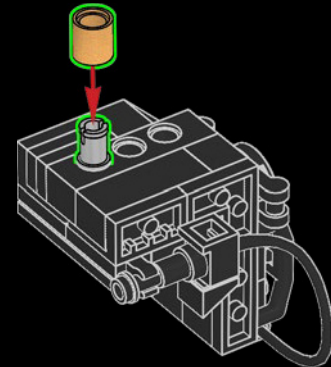

75

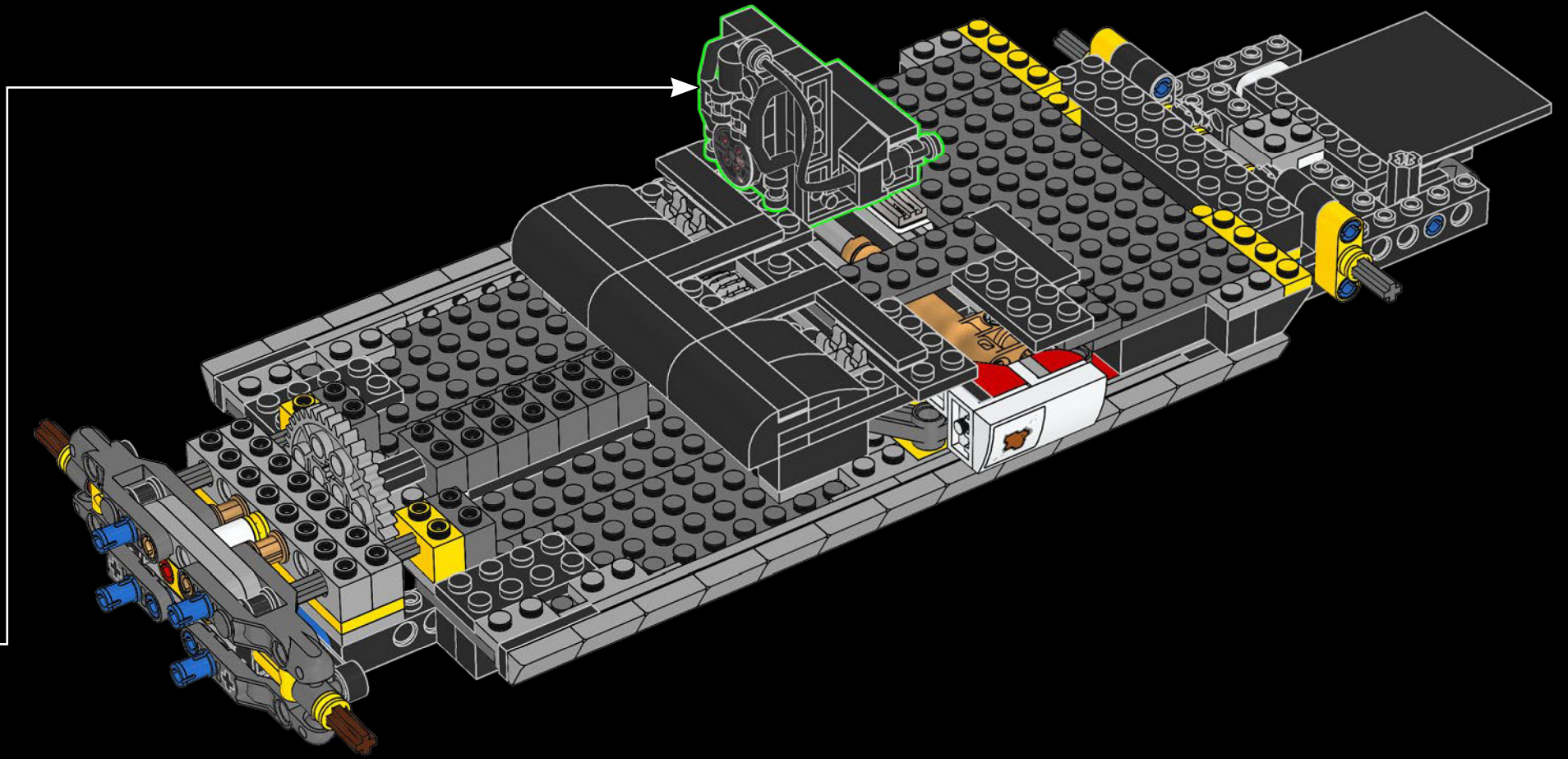

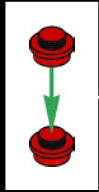
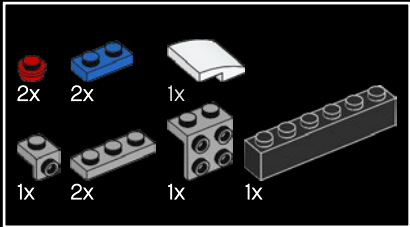
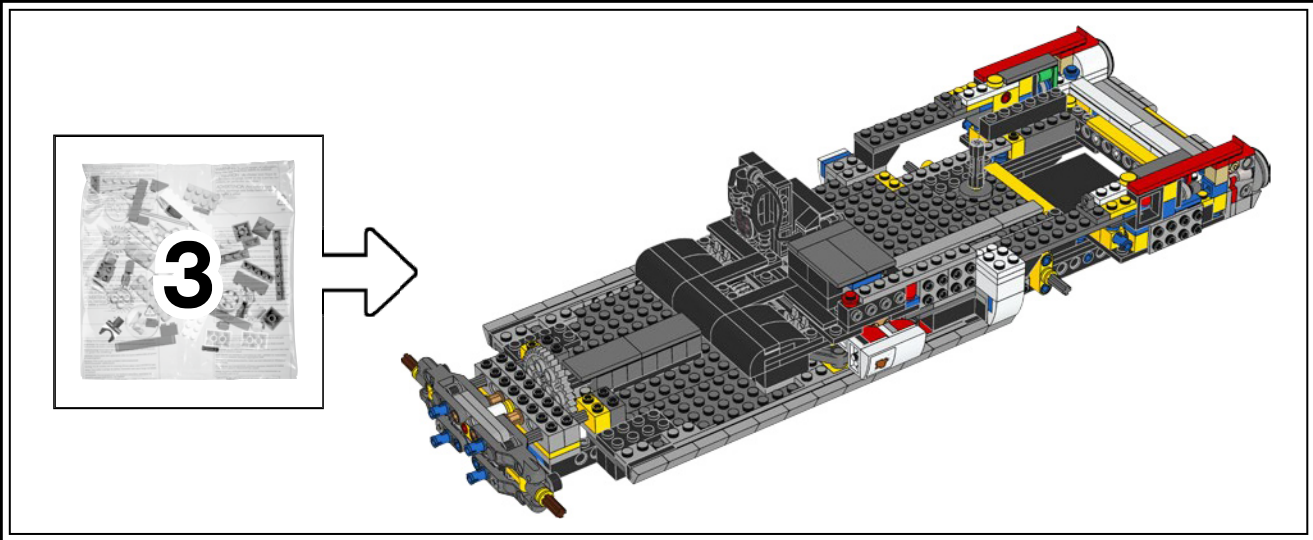

76

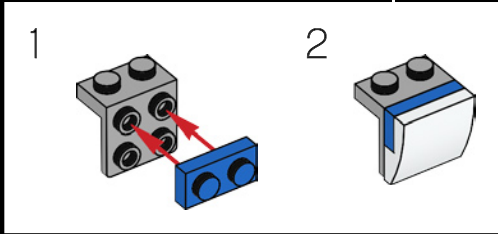
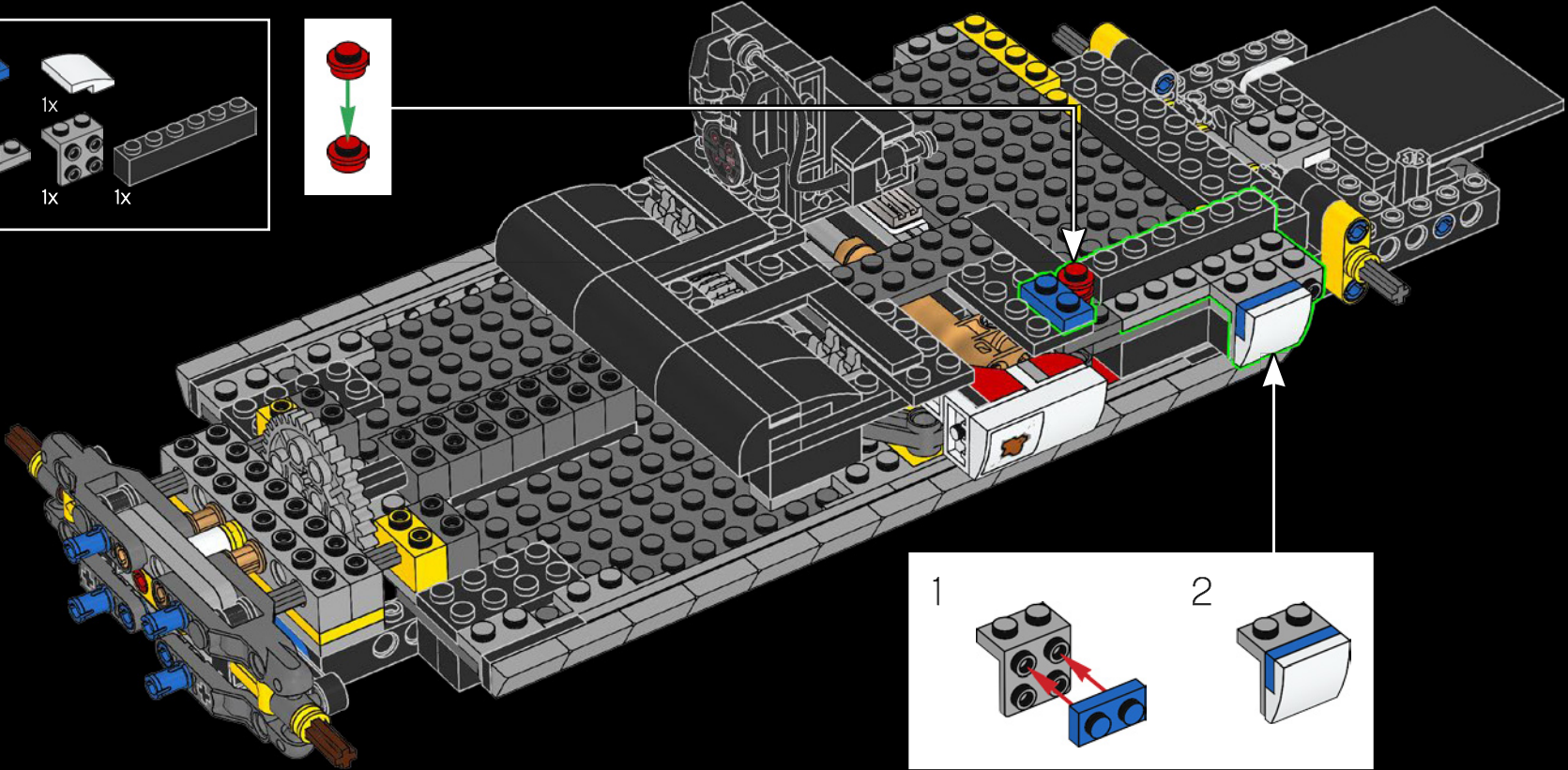



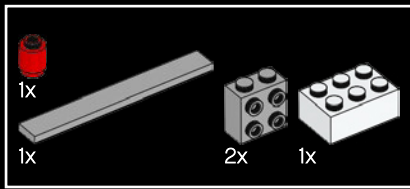

77

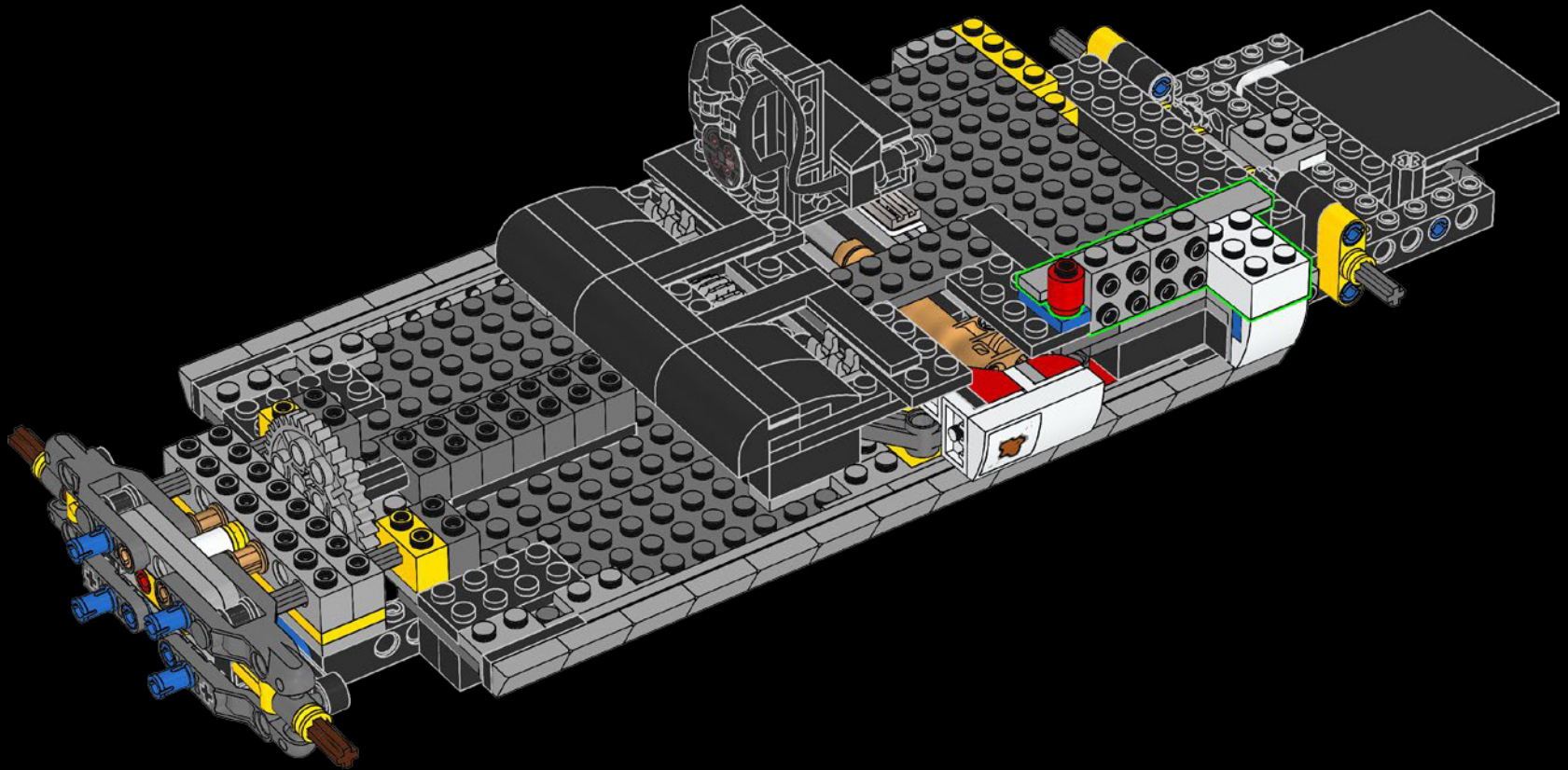

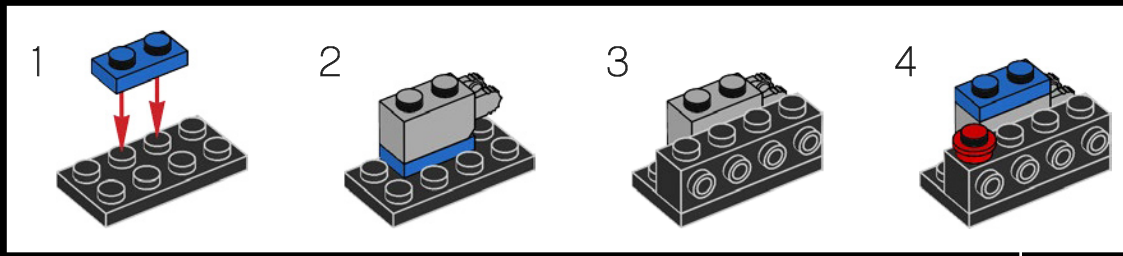
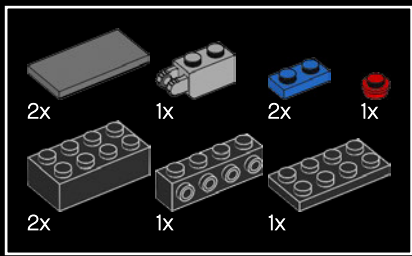

78

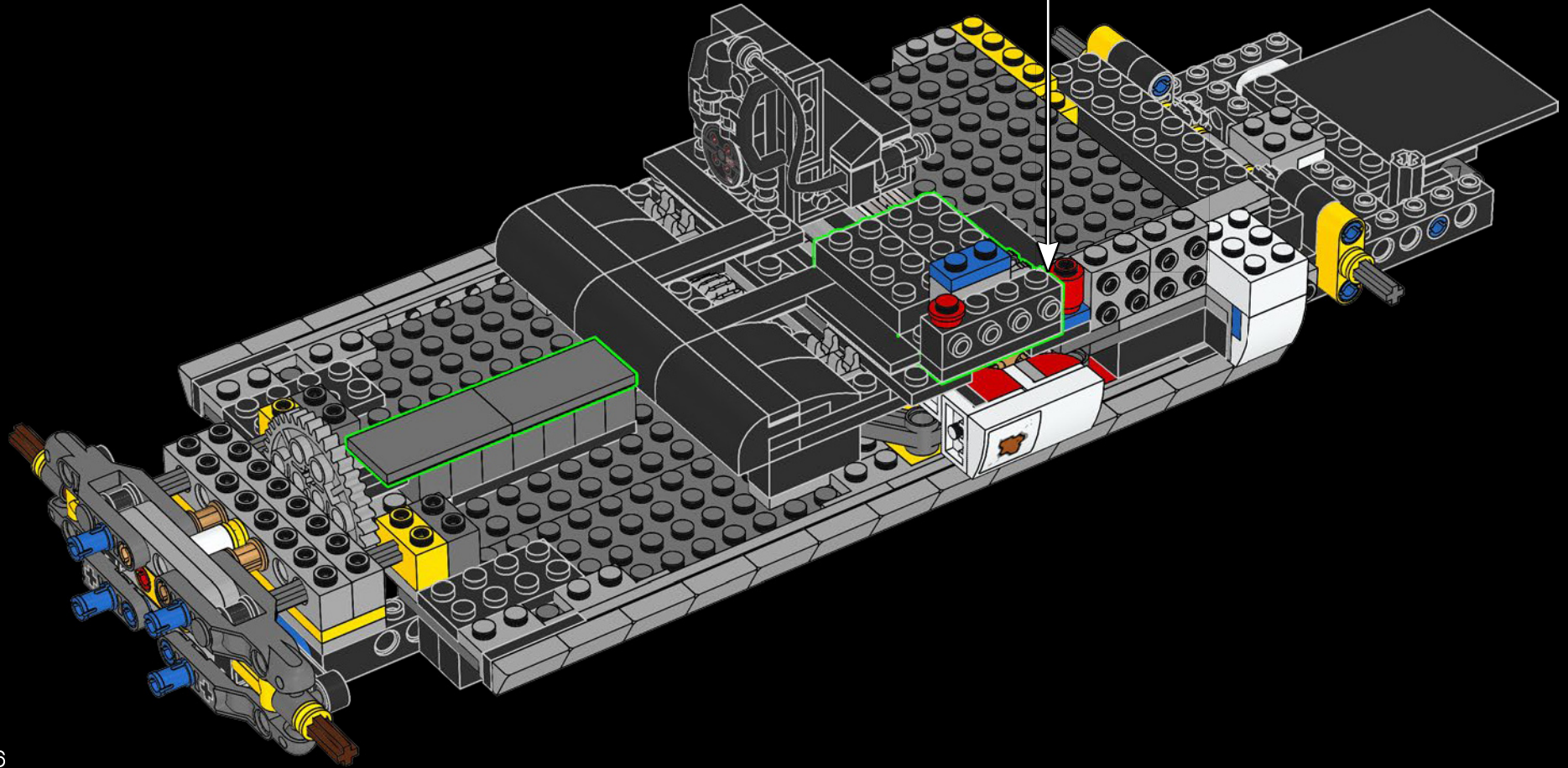

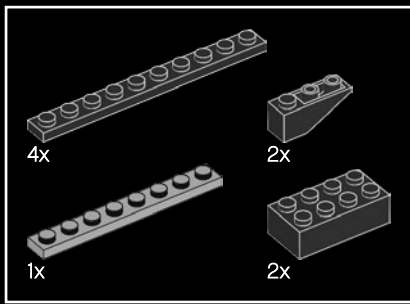

79

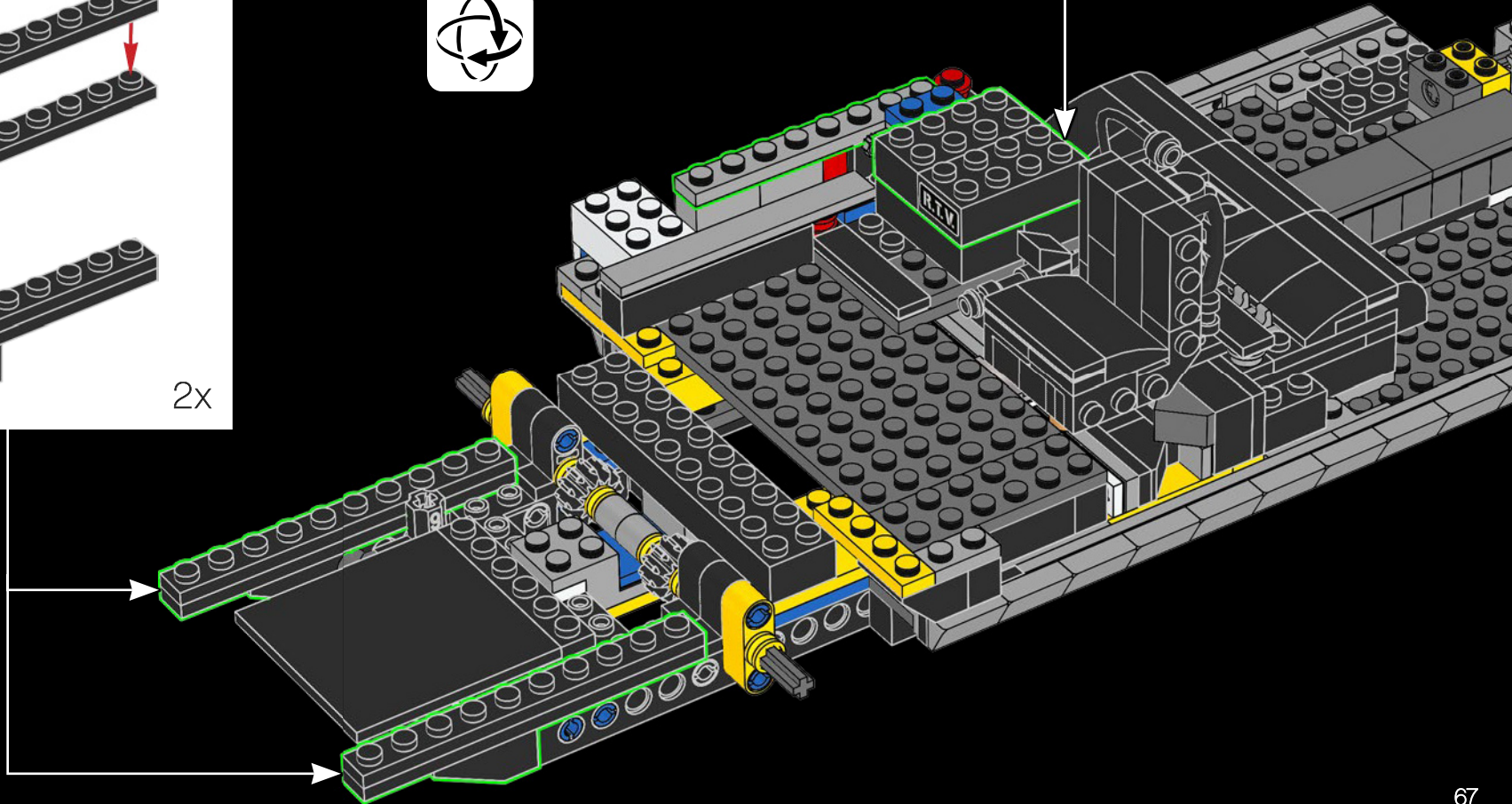
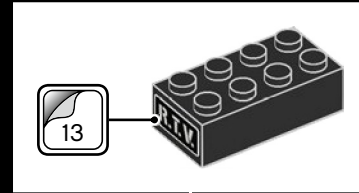
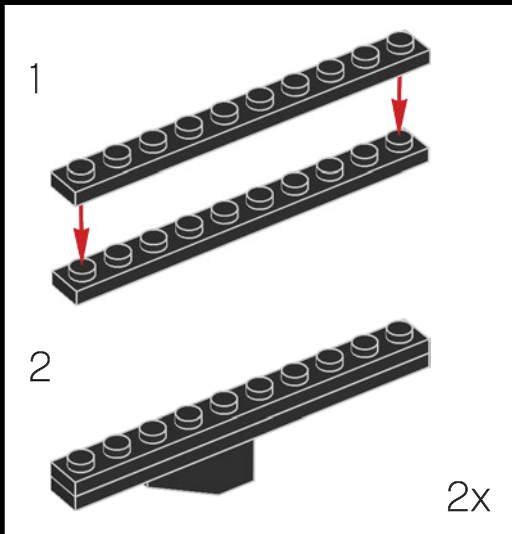

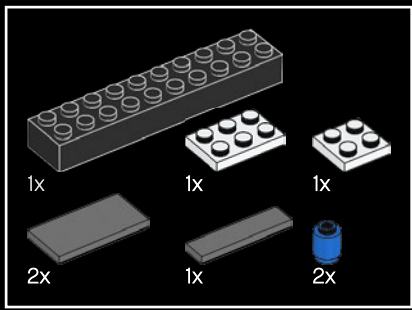

80

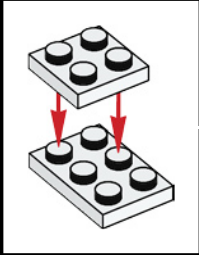
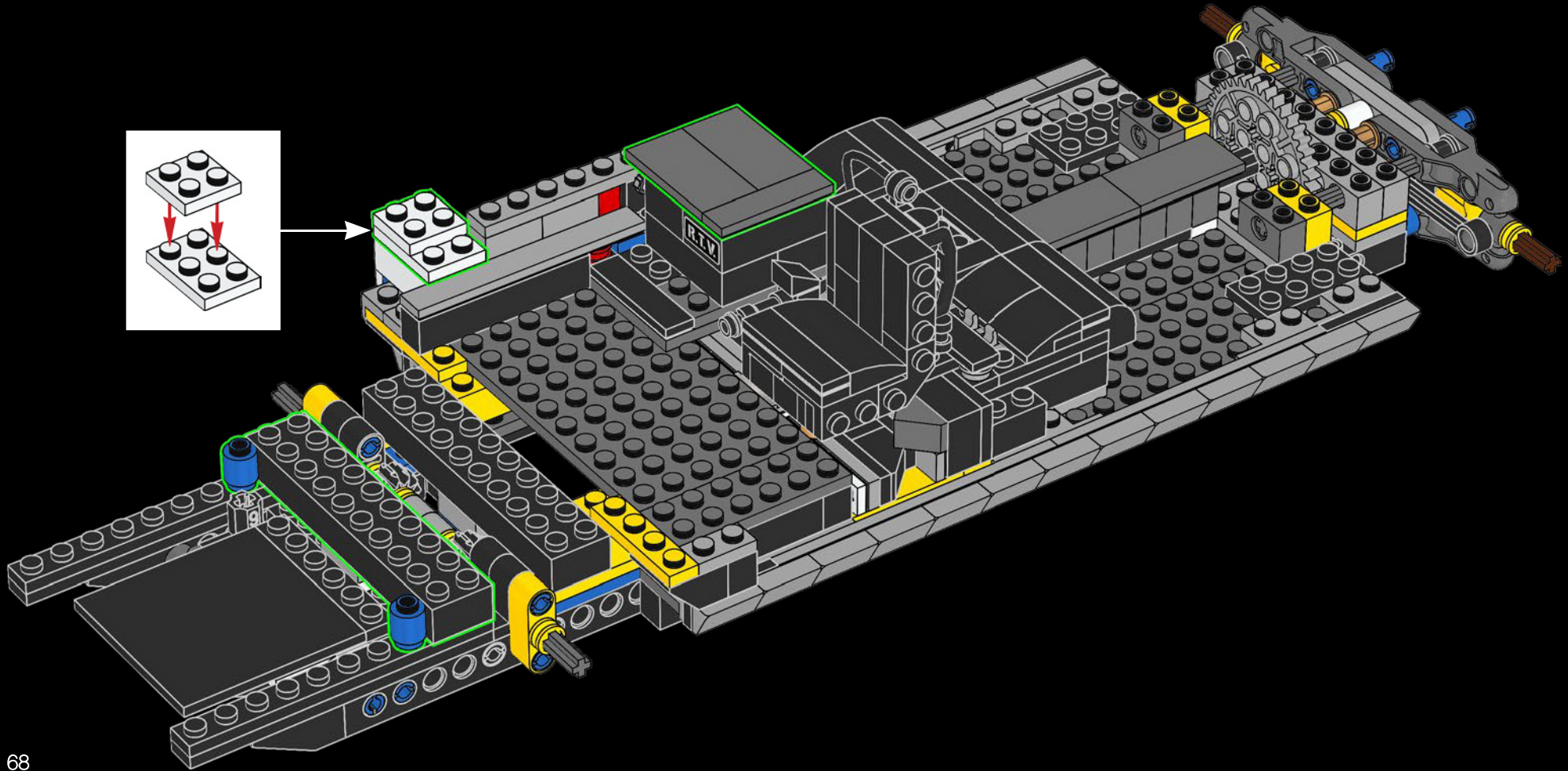

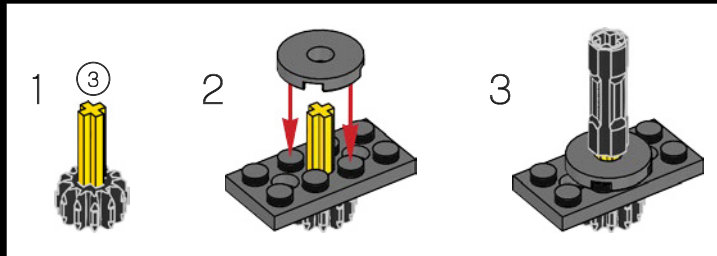
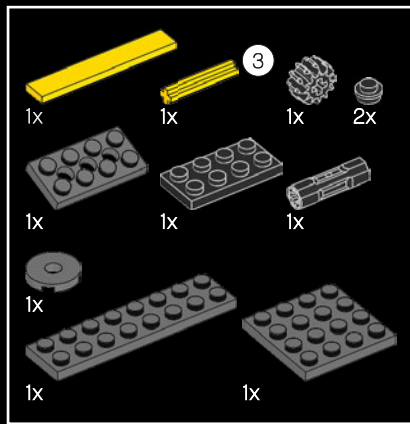

81

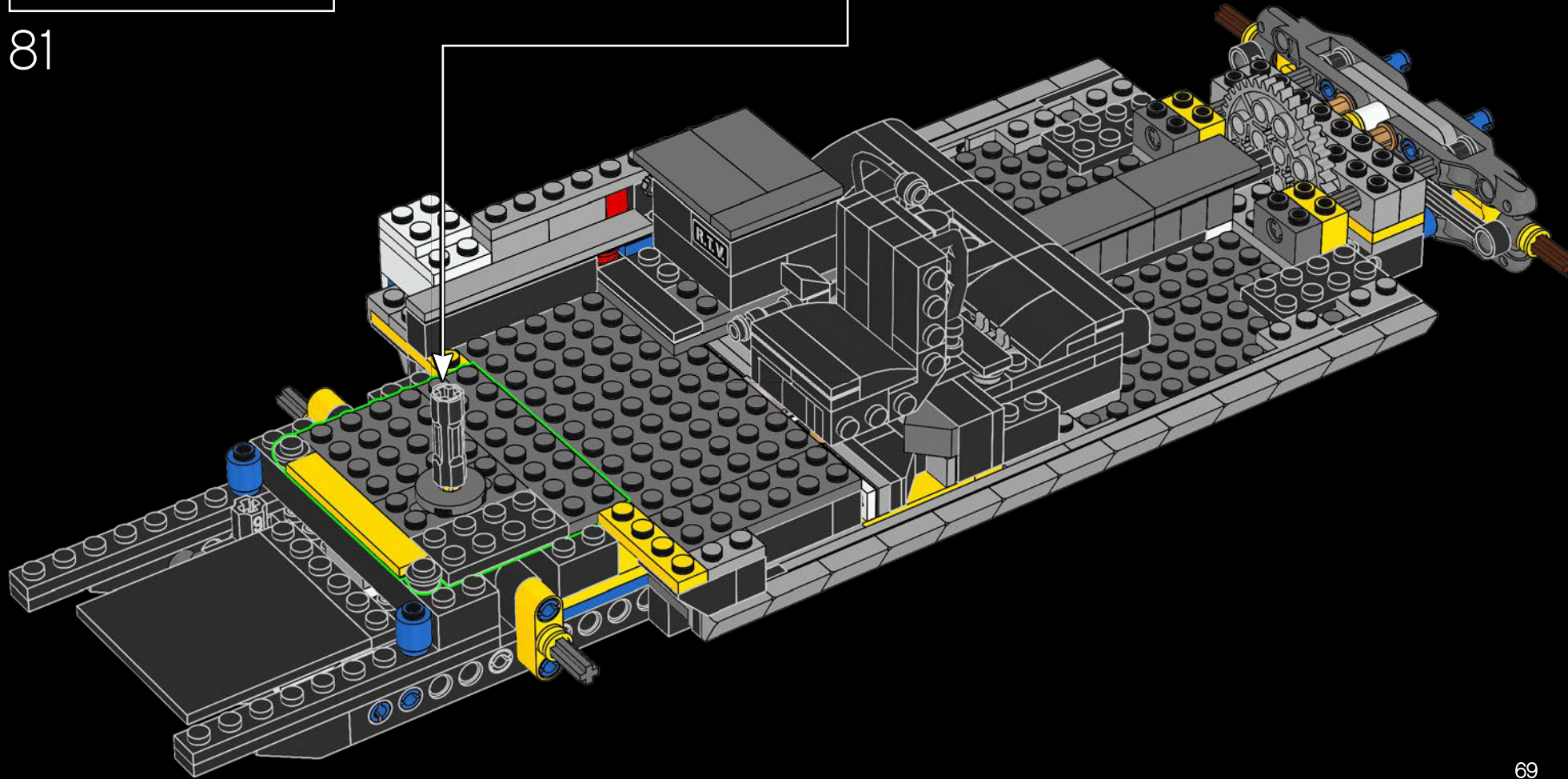

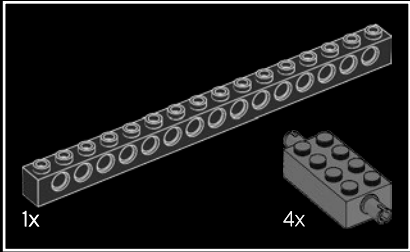
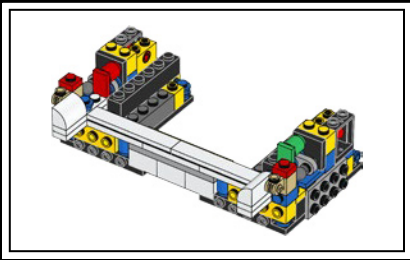

82

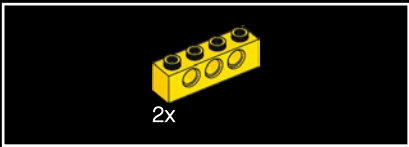
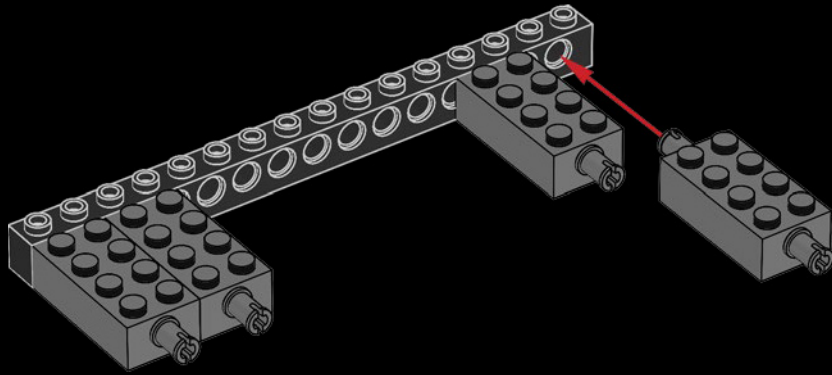

83

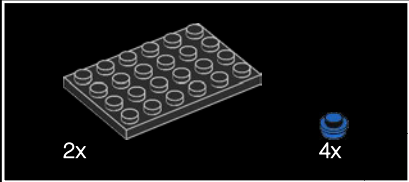
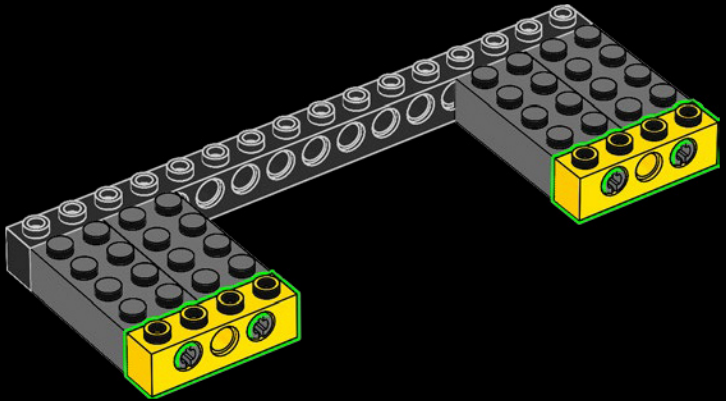

84

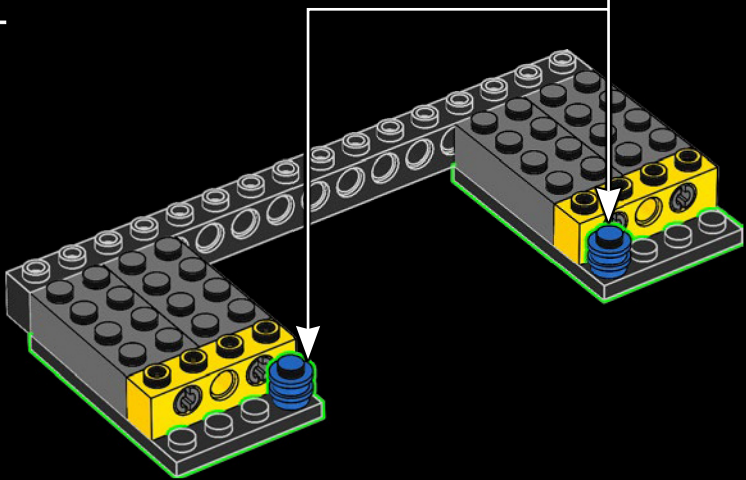
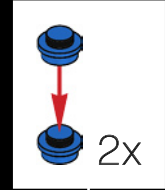

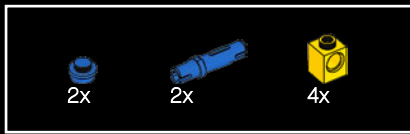

85

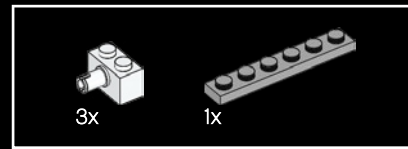
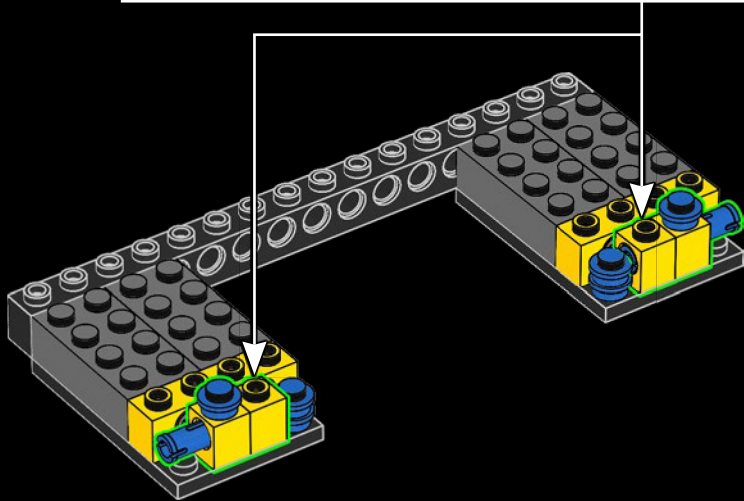
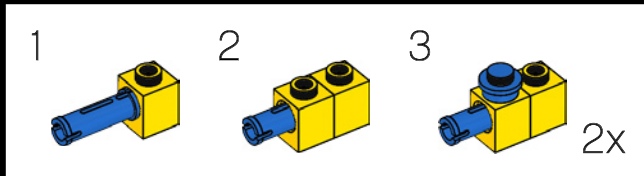

86

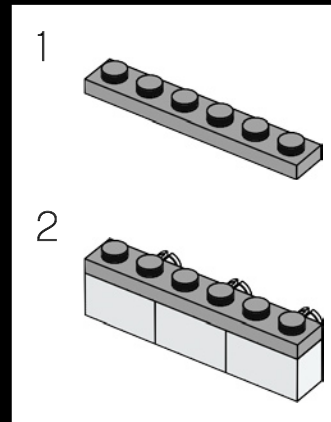
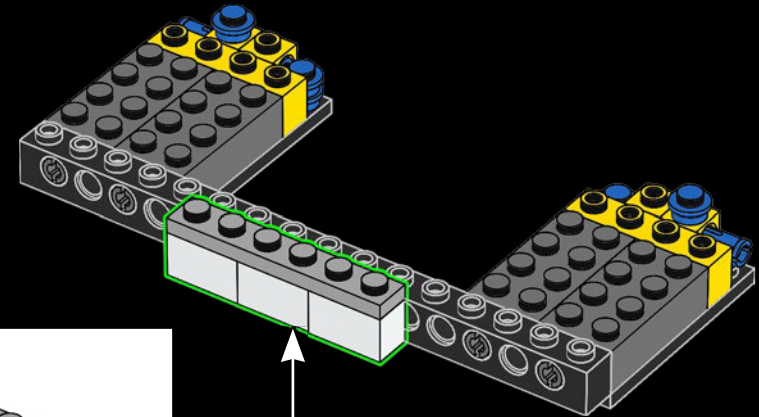

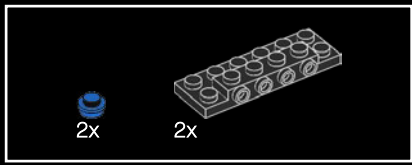

87

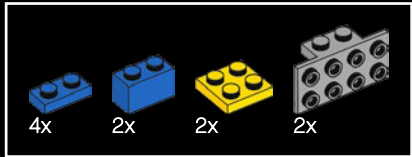
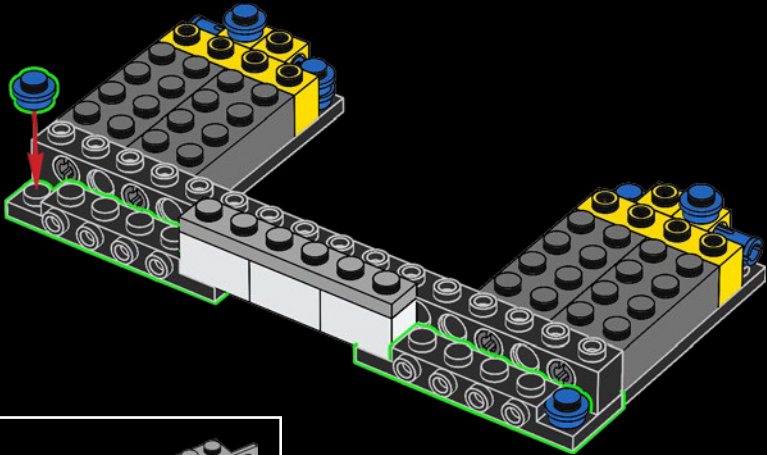

88

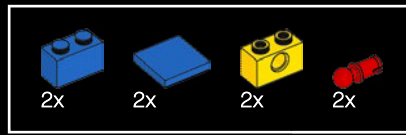
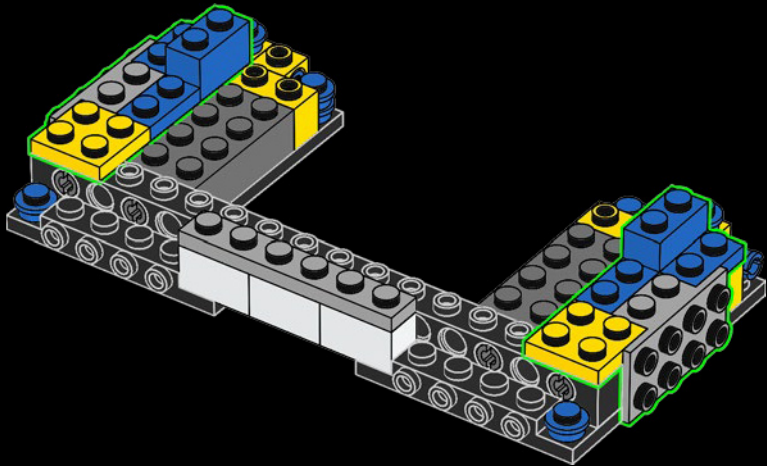

89

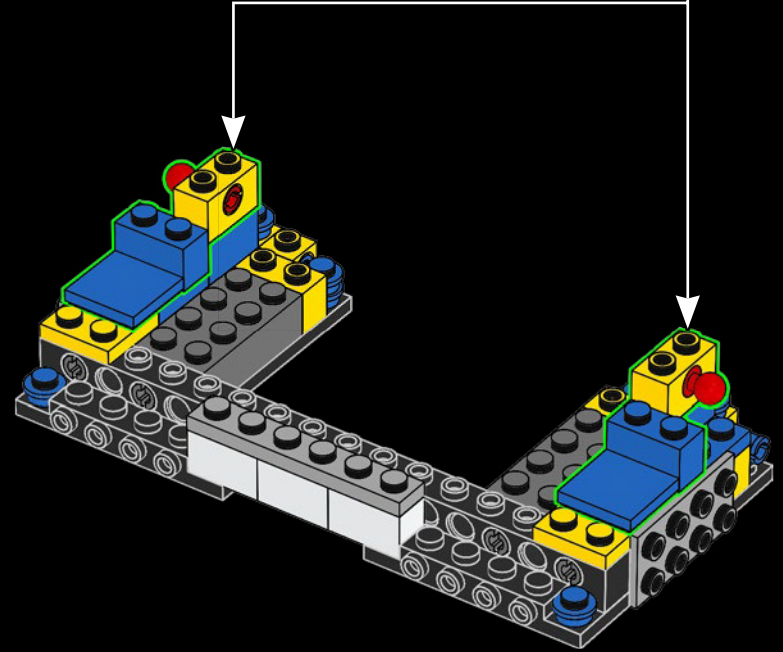
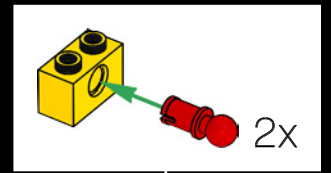



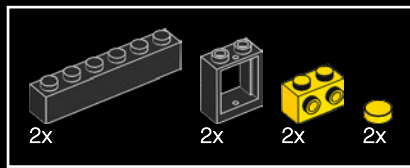

90

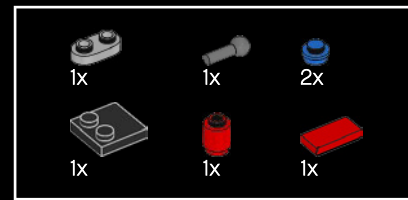
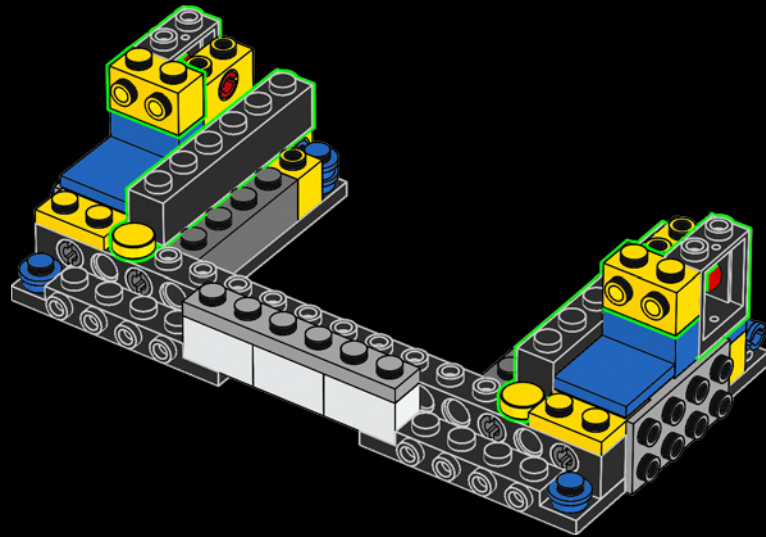

91

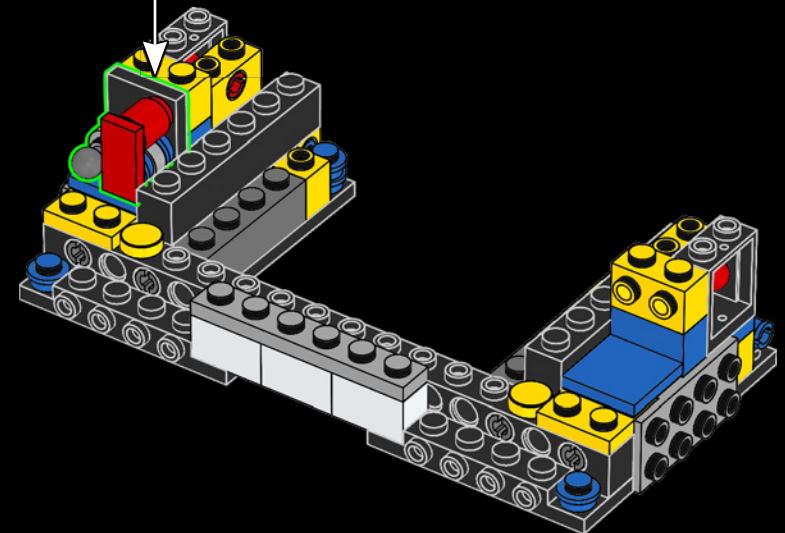
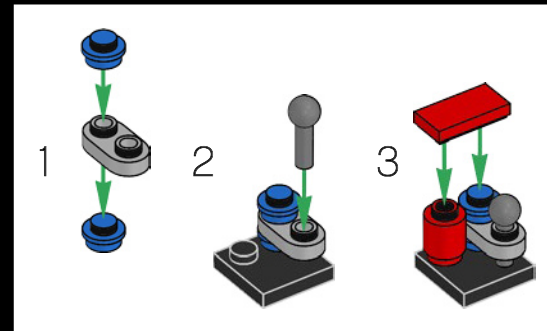

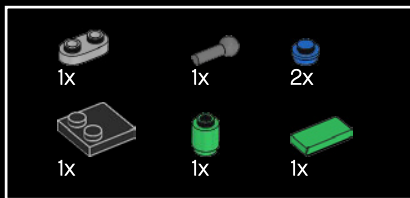

92

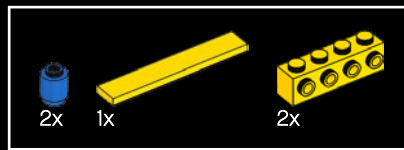
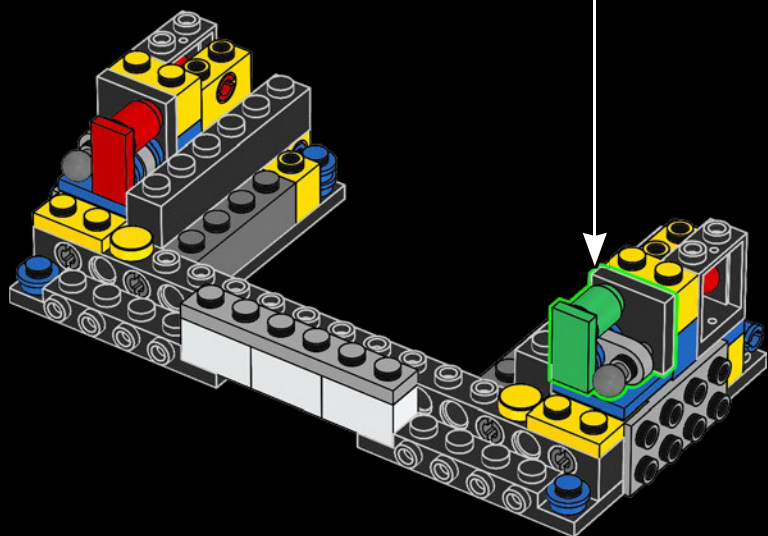
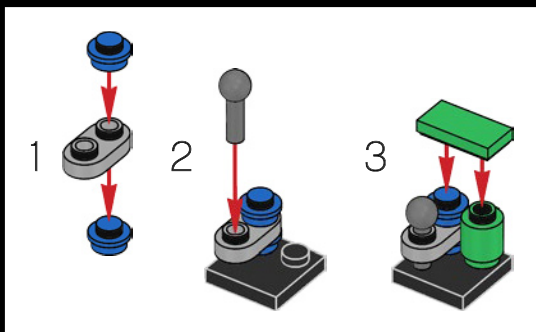

93

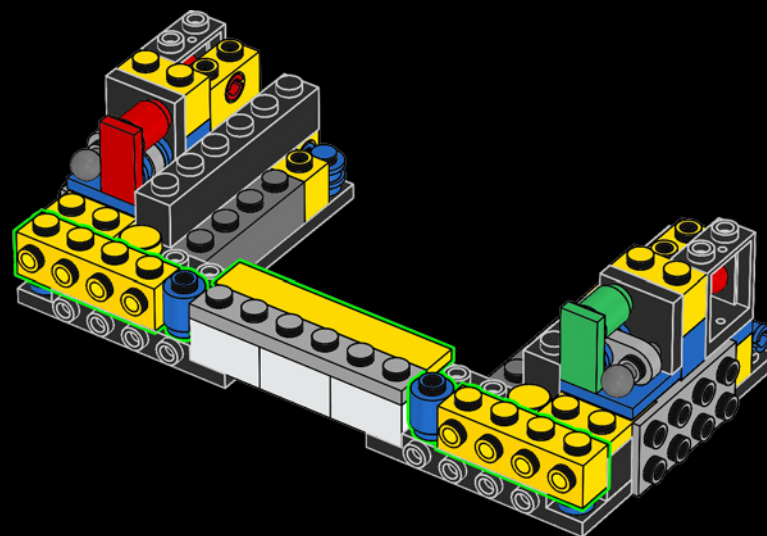

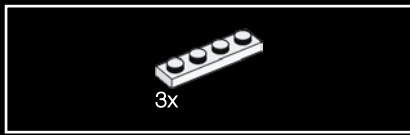

94

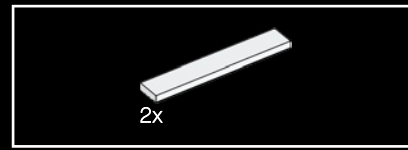
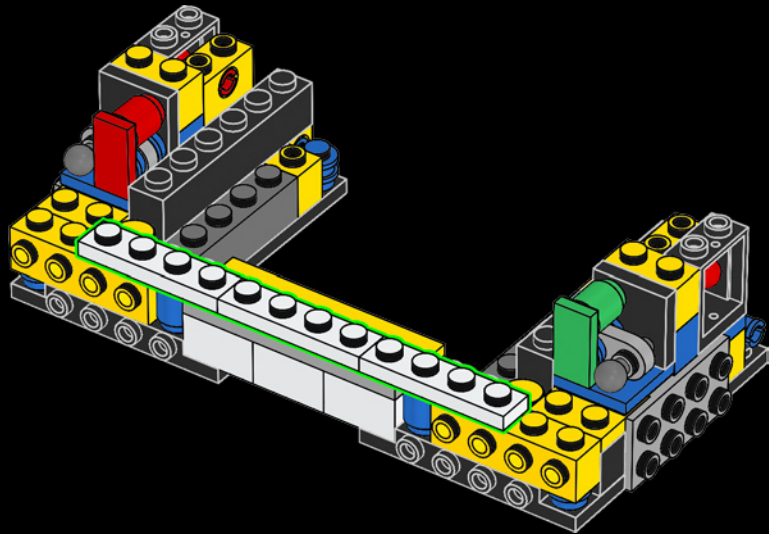

95

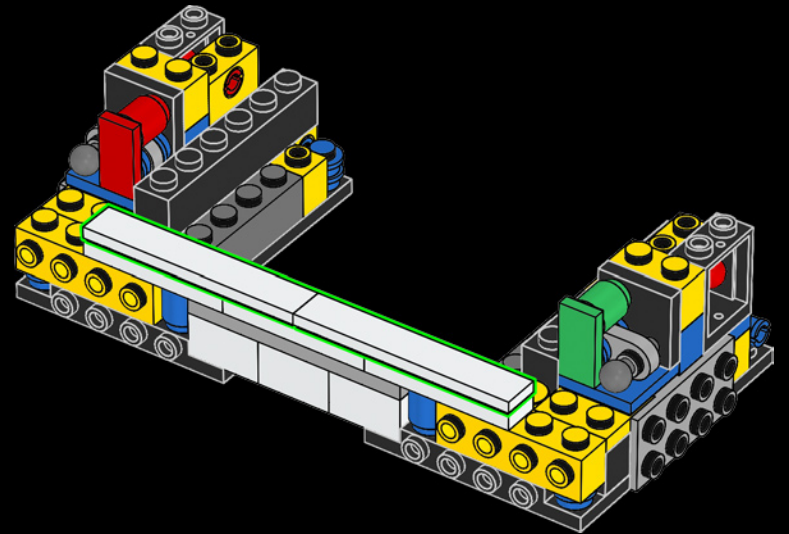

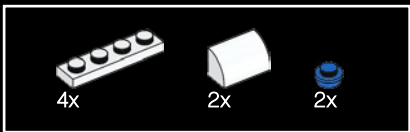

96

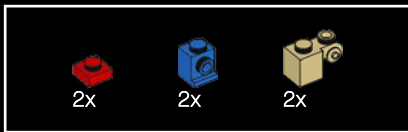
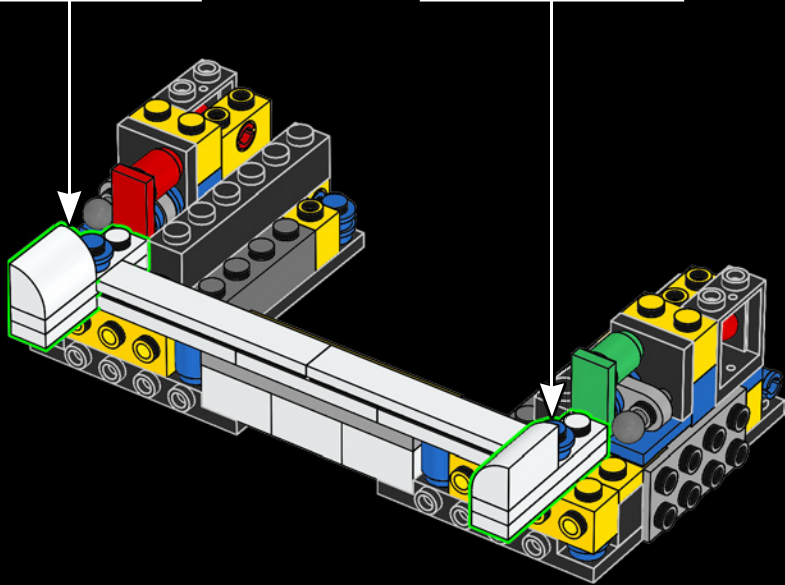
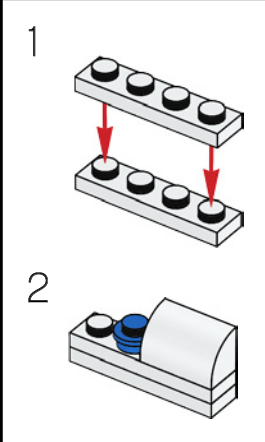
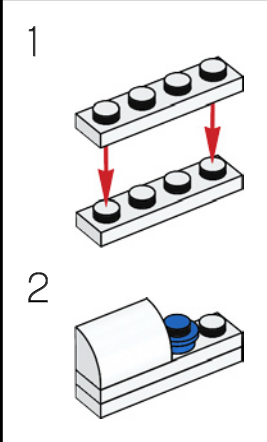

97

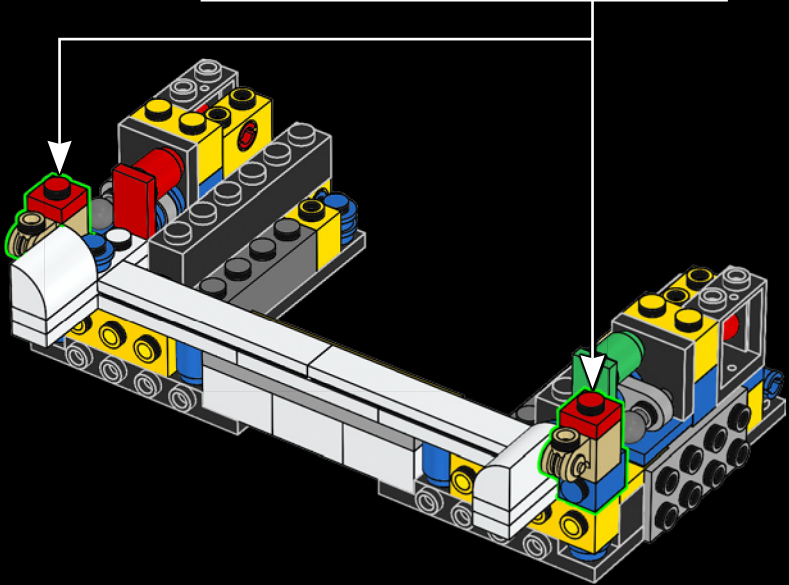
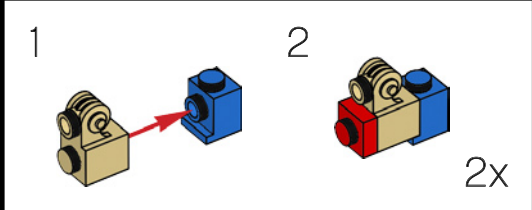

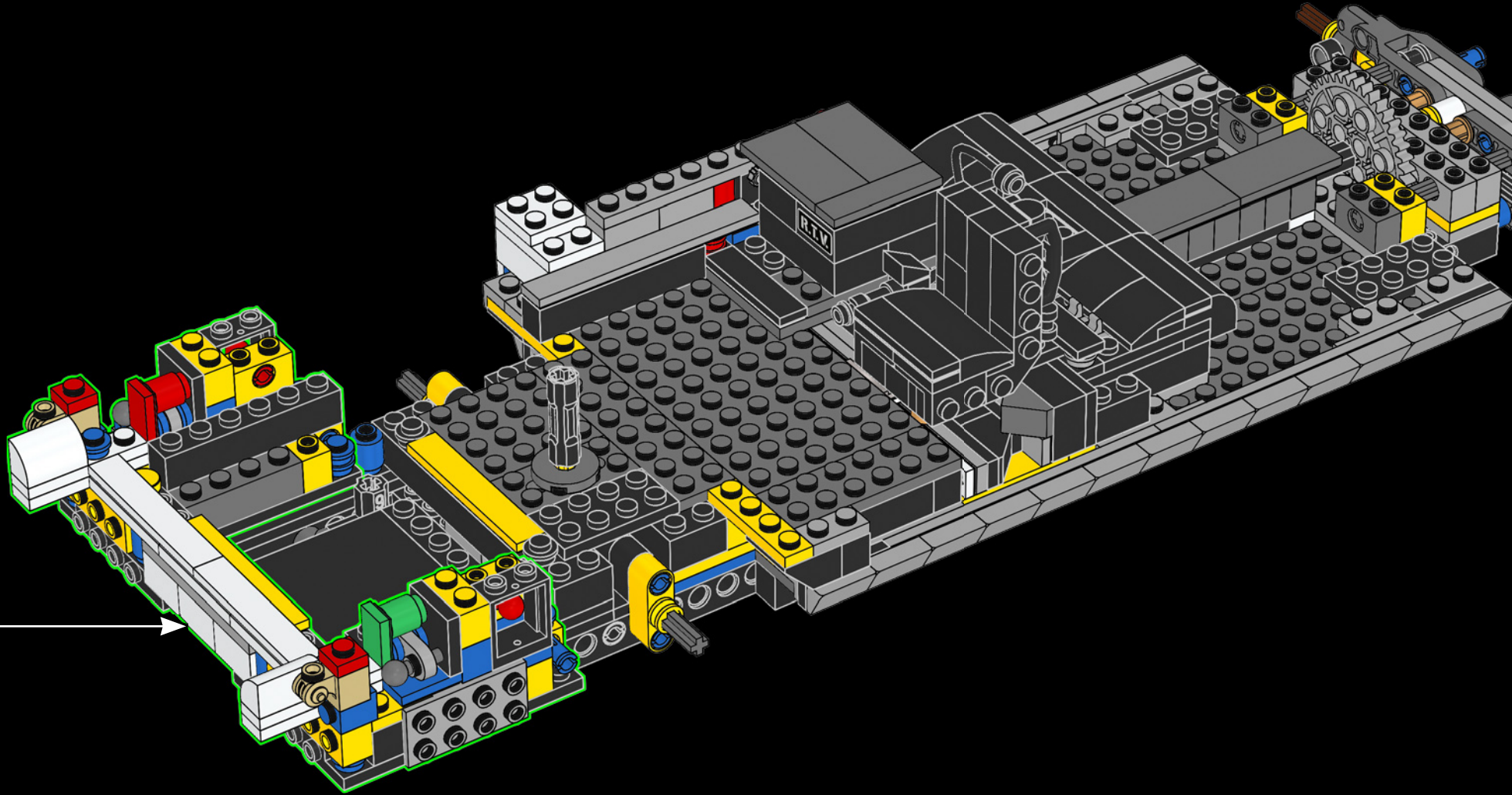

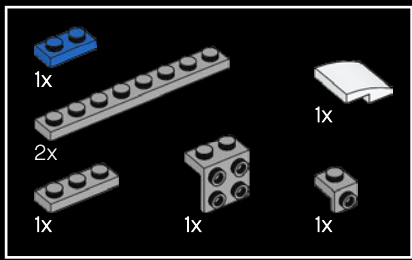

99

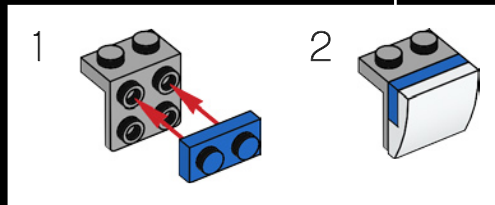
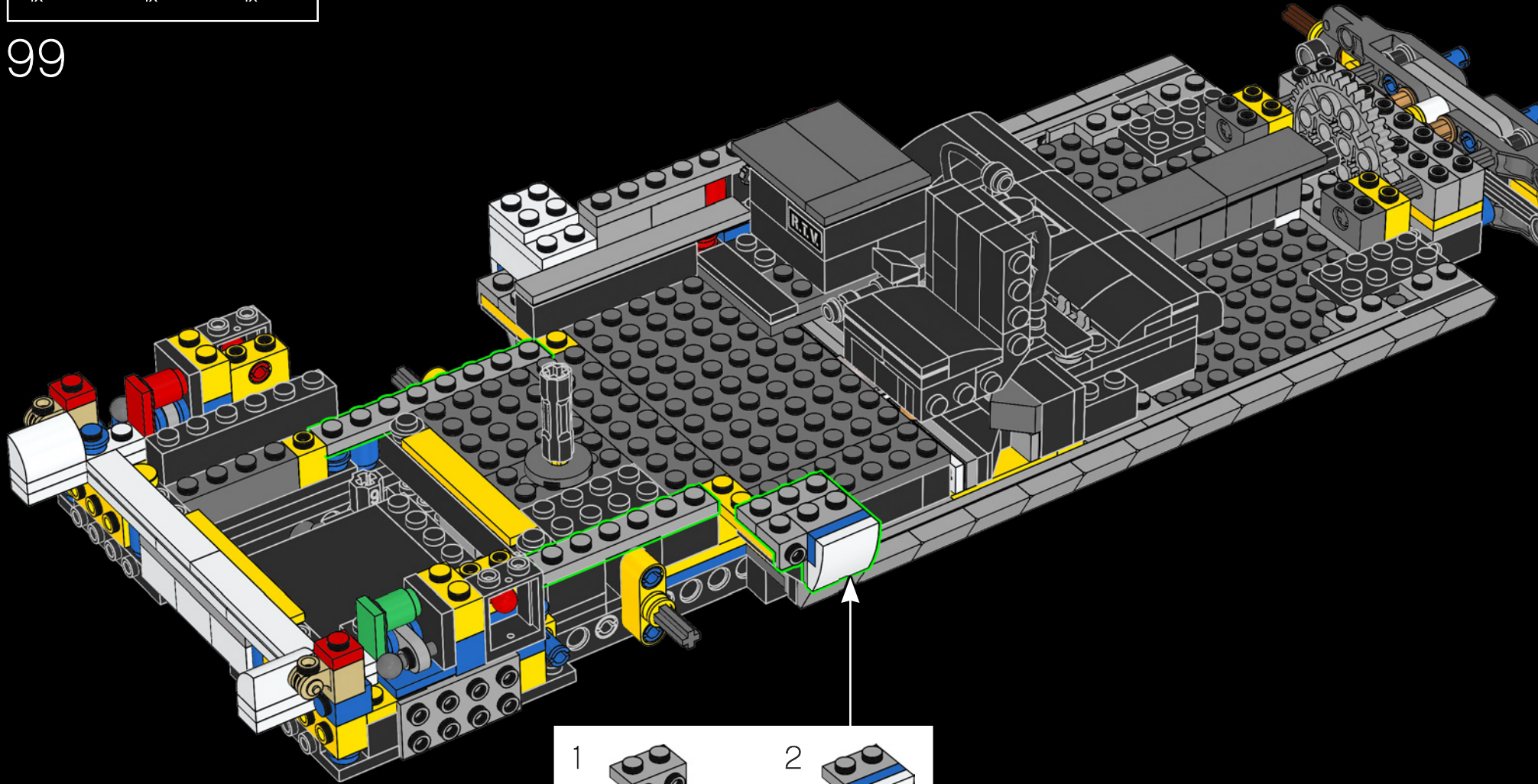

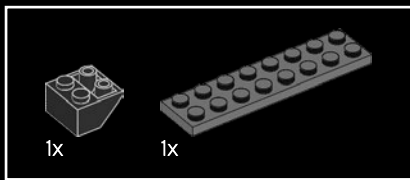

100

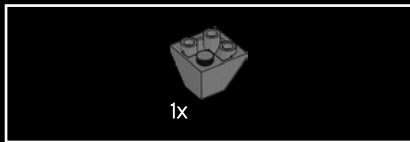
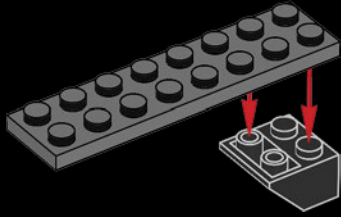

101

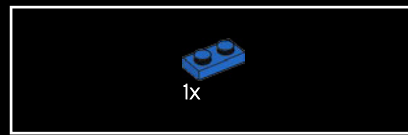
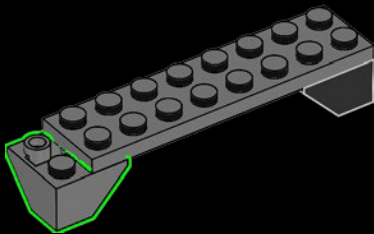

102

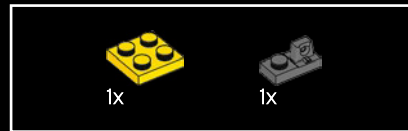
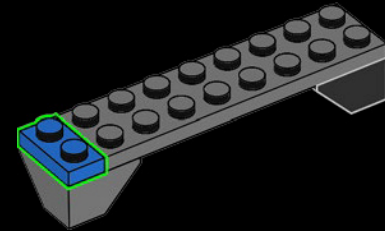

103

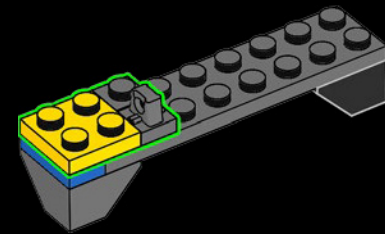

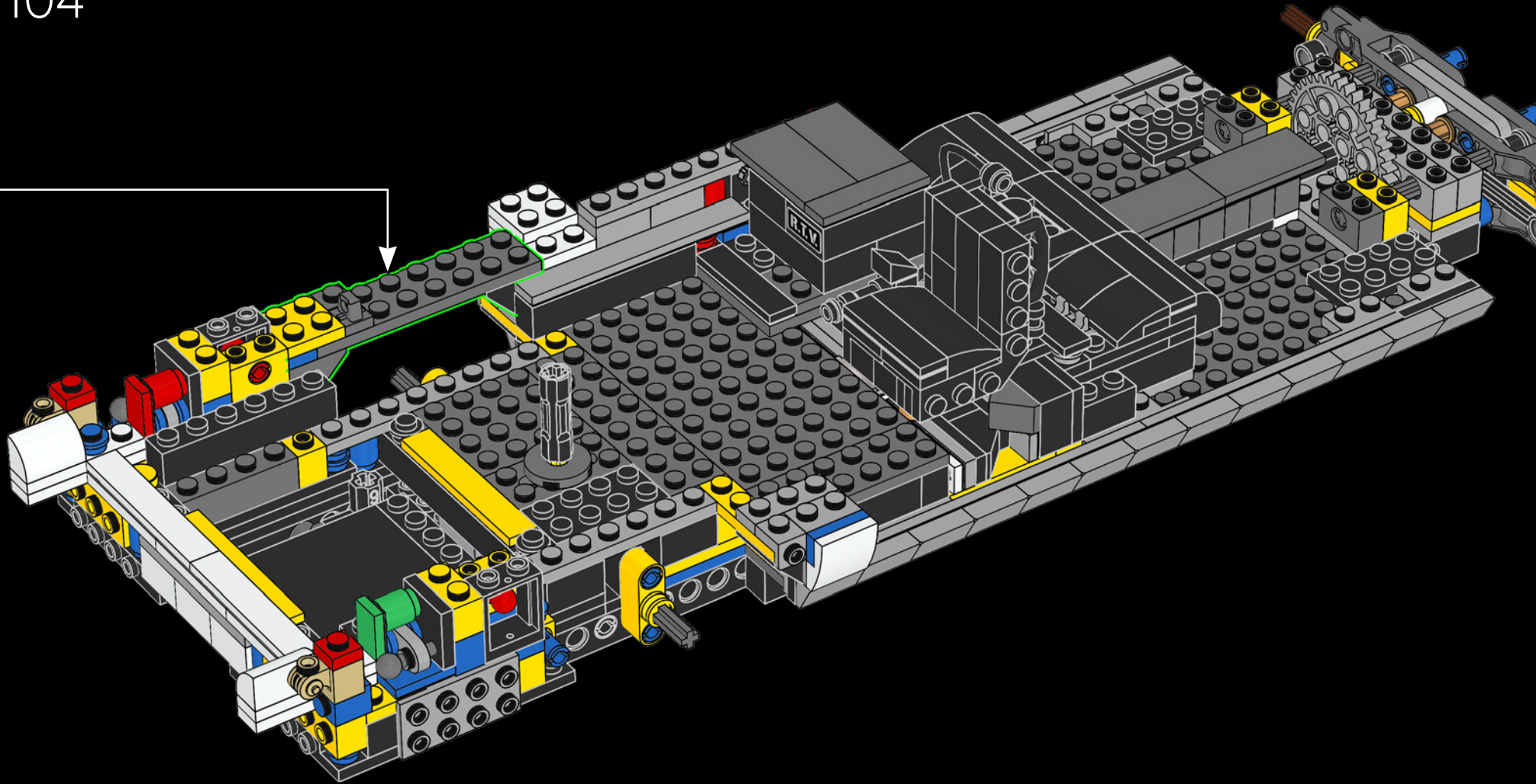



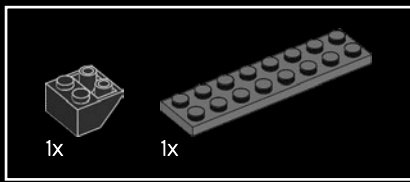

105

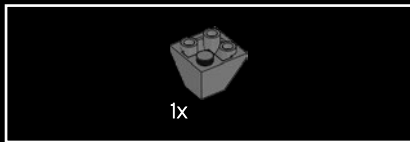
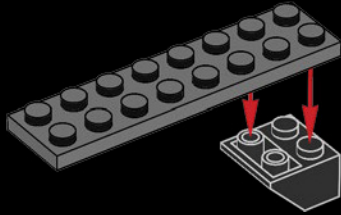

106

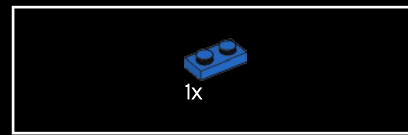
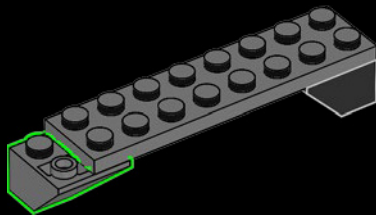

107

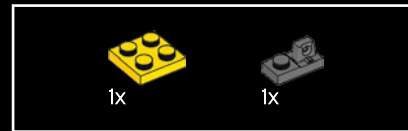
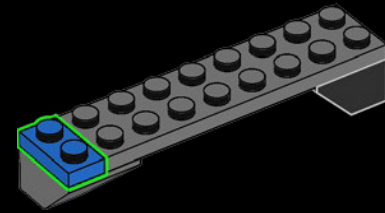

108

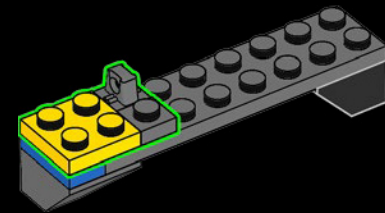

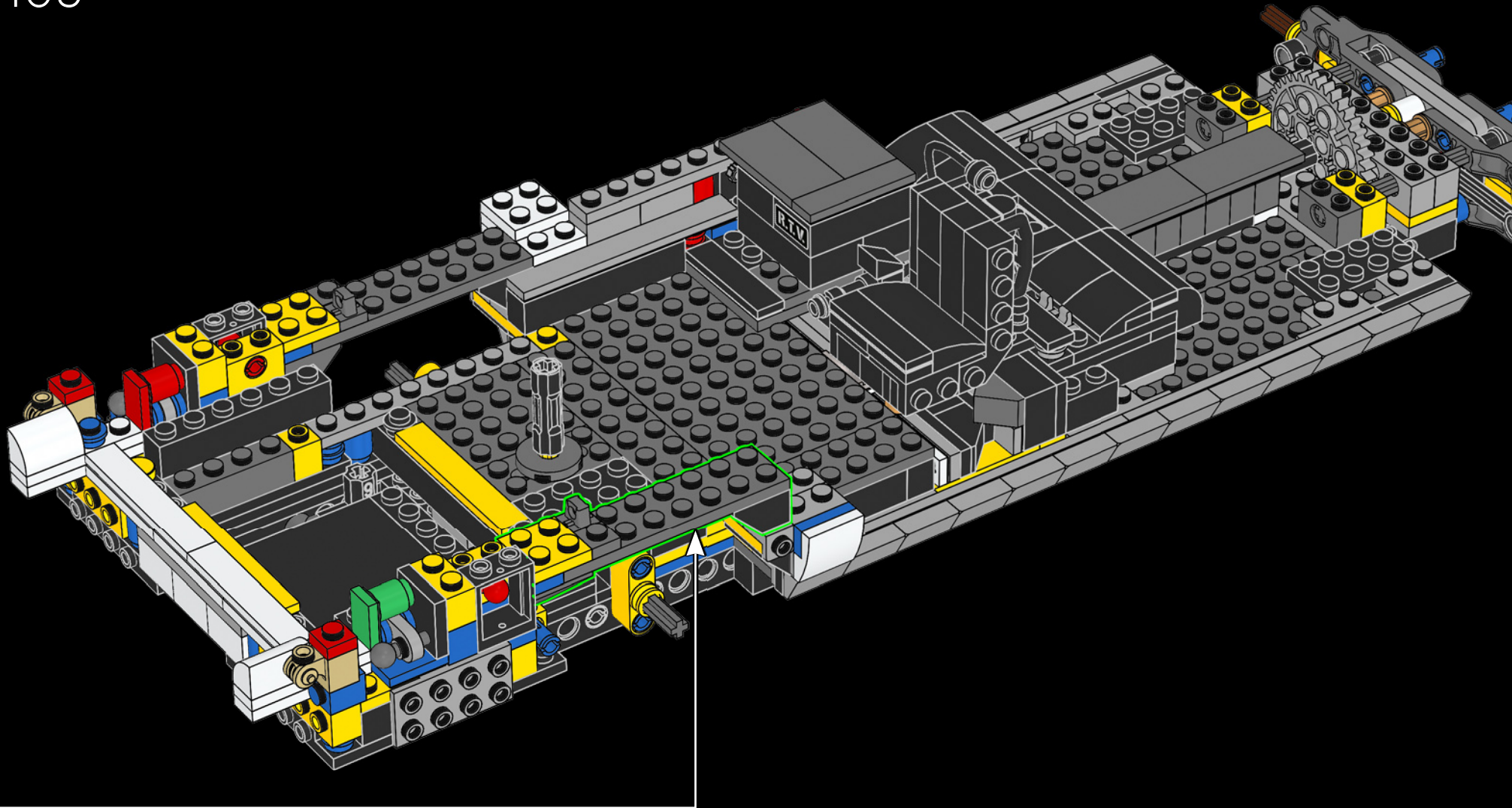

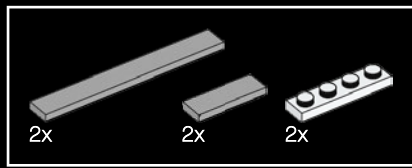

110

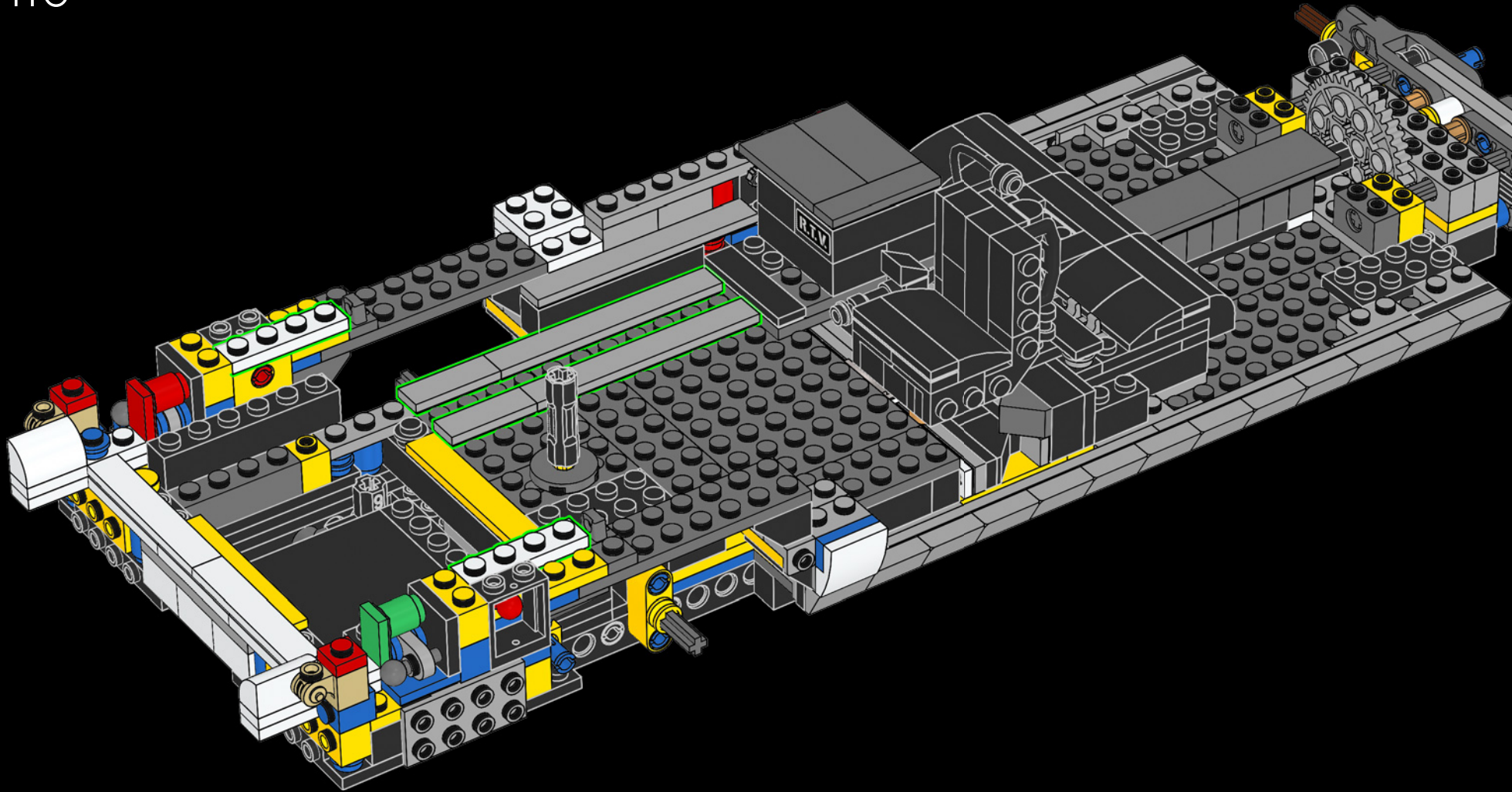

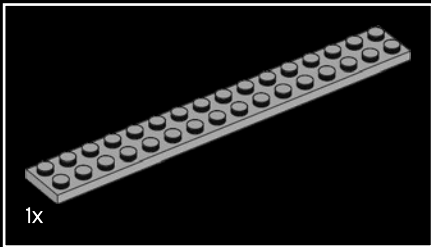
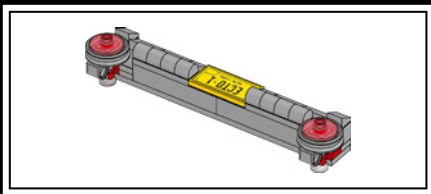

111

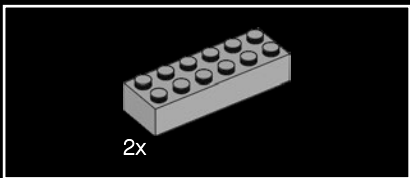
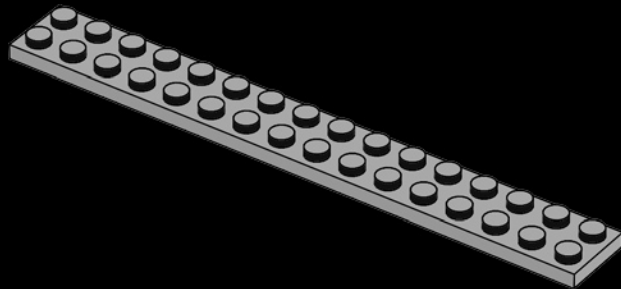

112

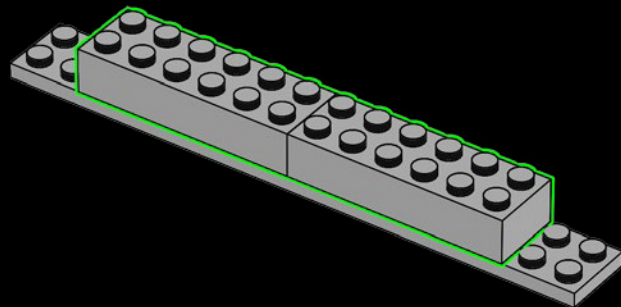

113

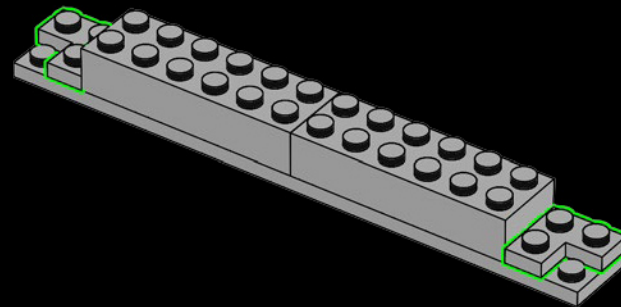

114

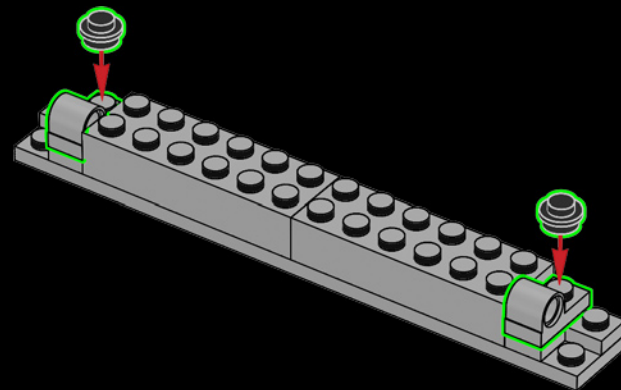

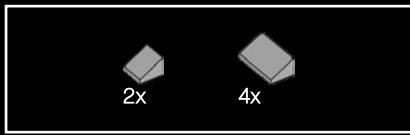

115

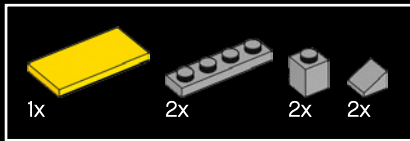
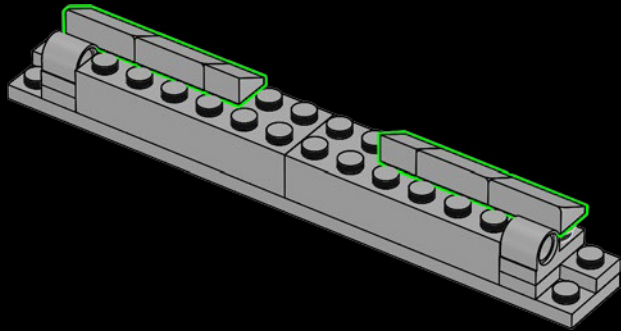

116

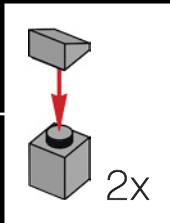
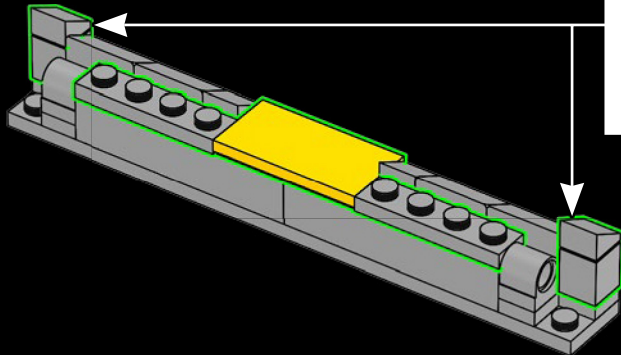

117

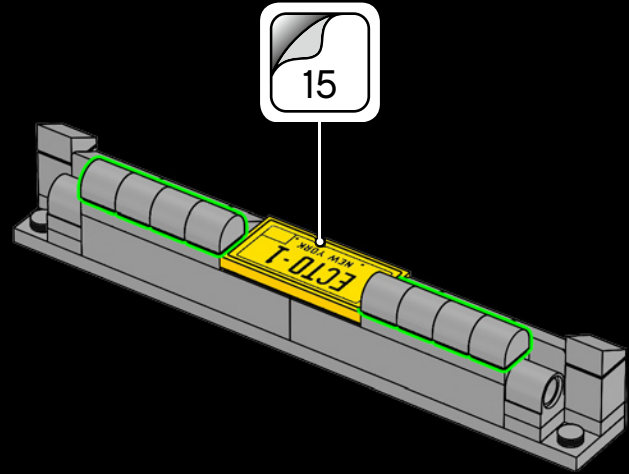

118

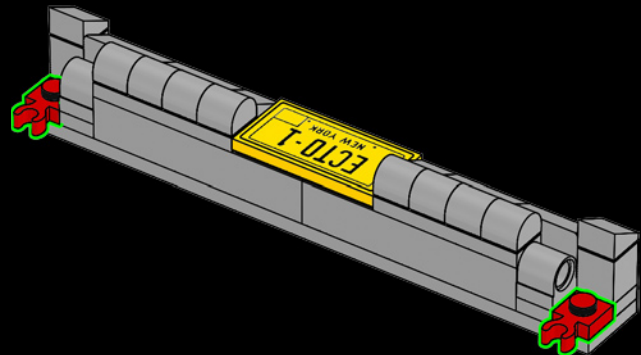

2x

119

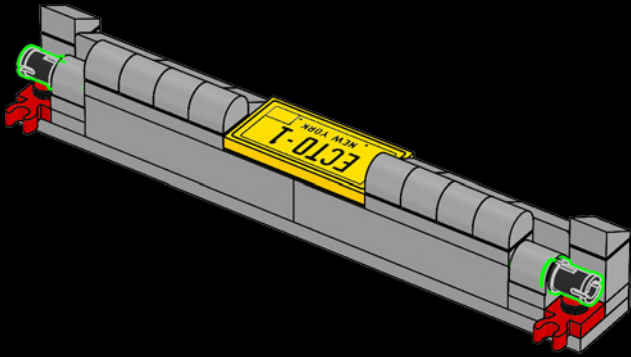

2x

120

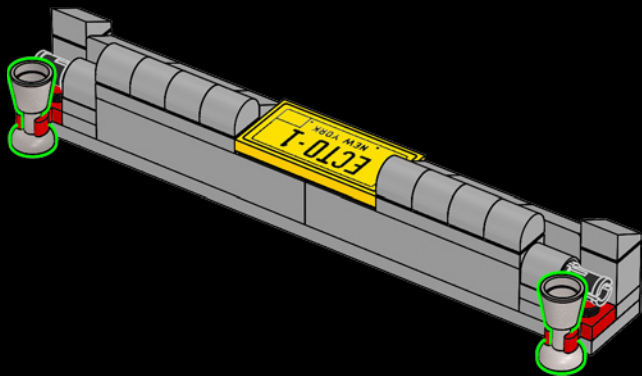

2x

121

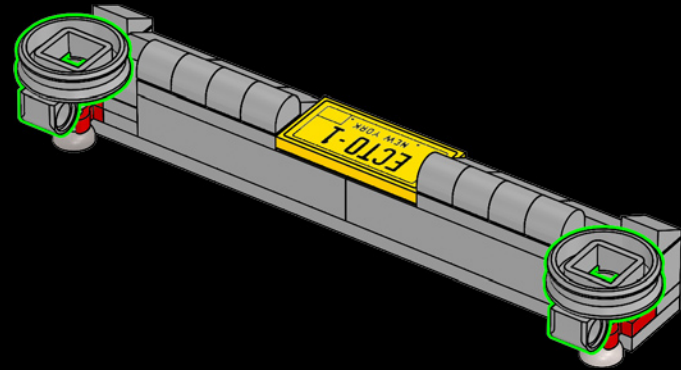

2x

2x

2x

122

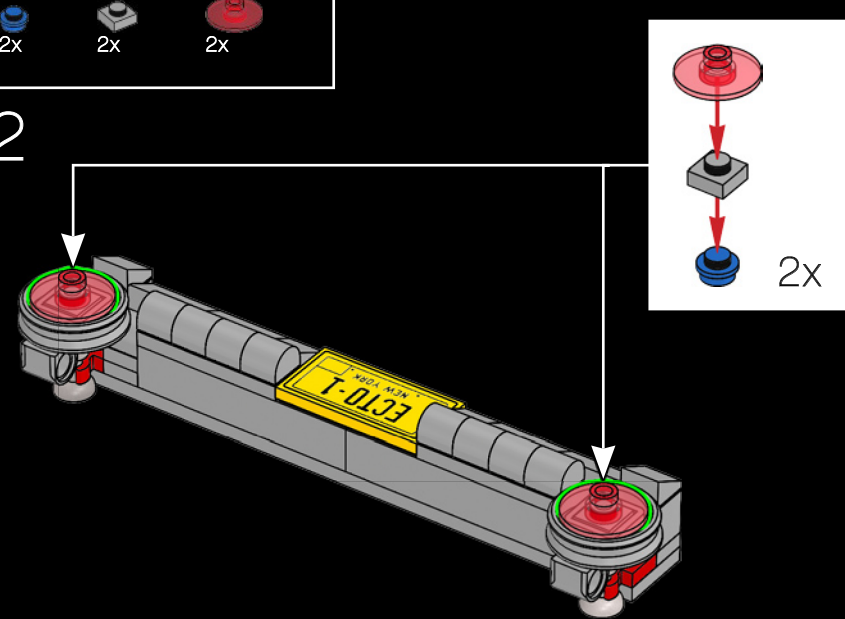

123

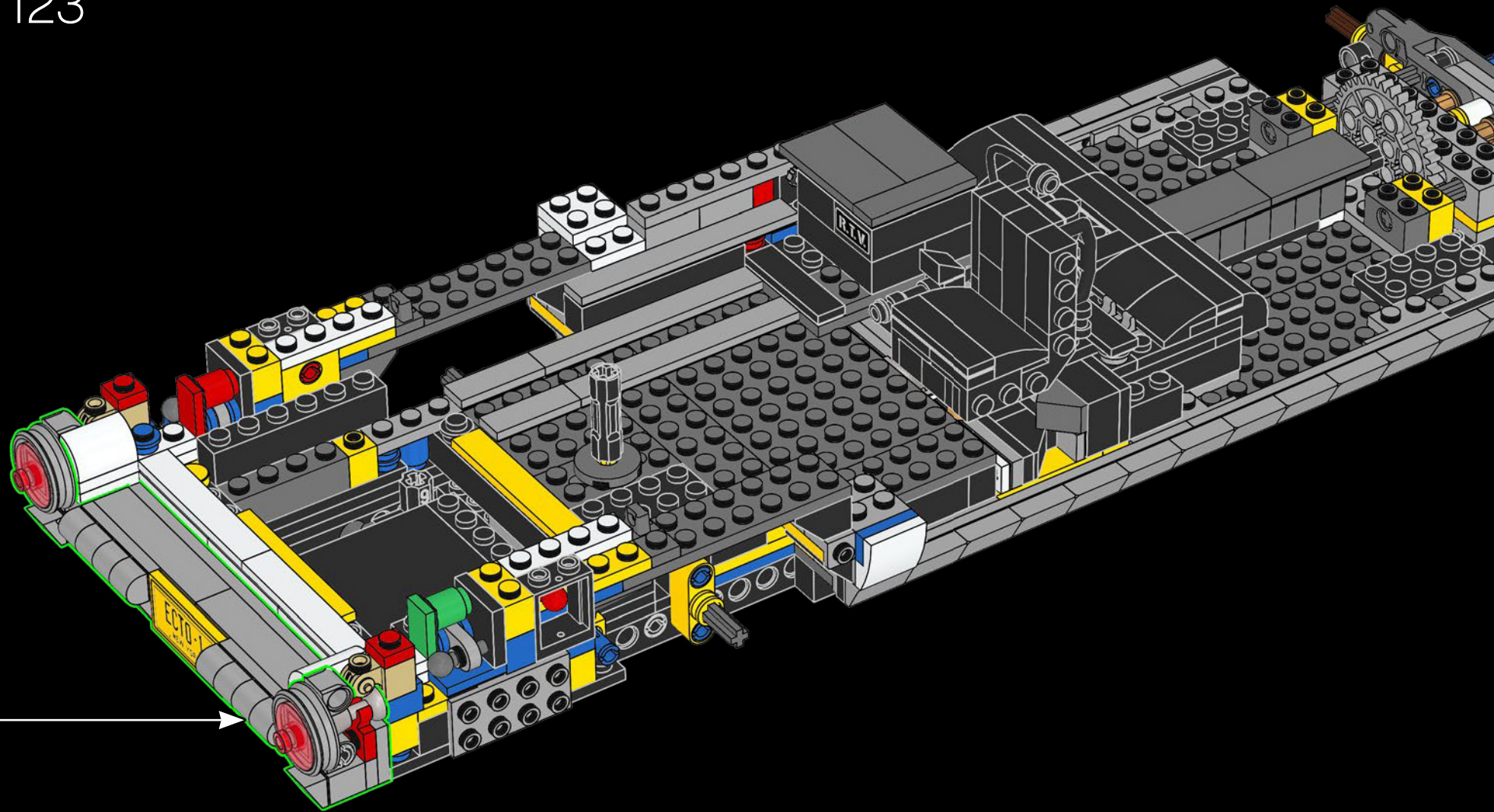

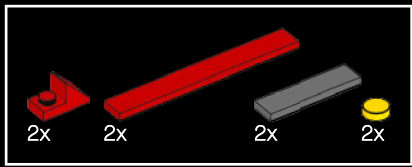

124

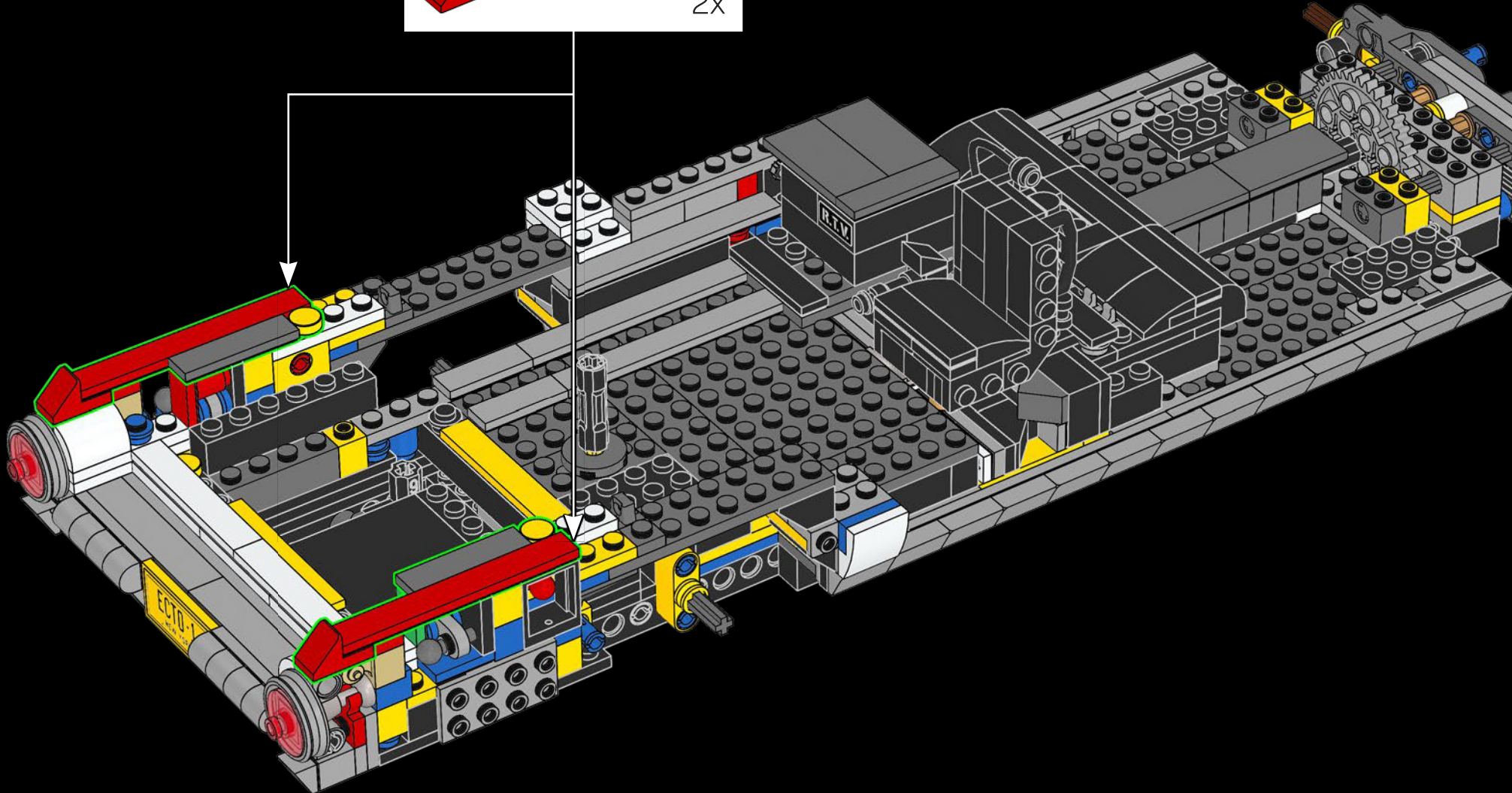
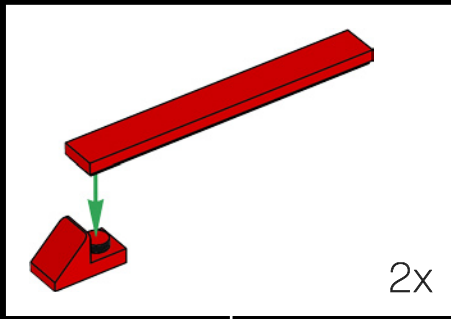



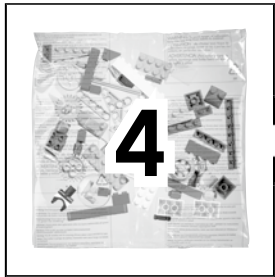

4

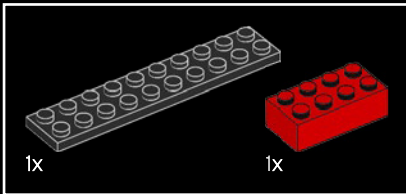
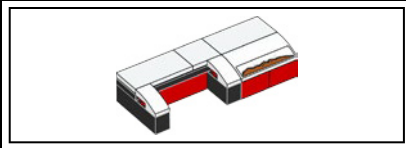
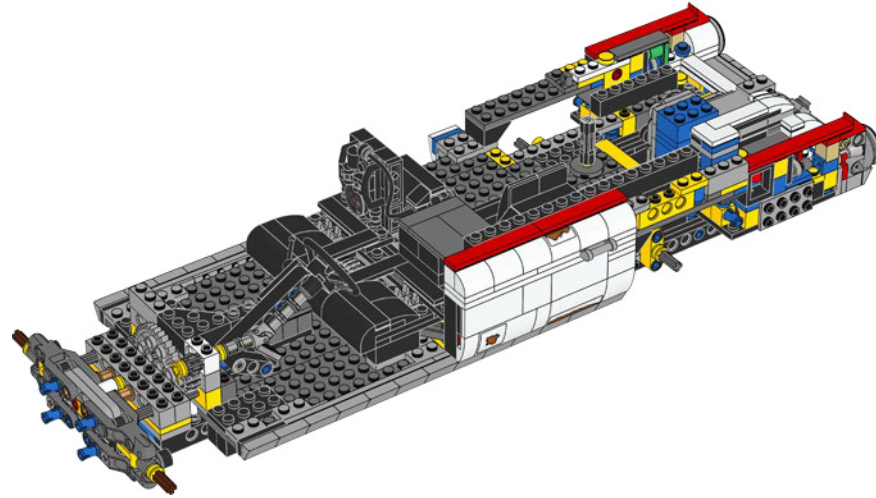
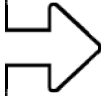

125

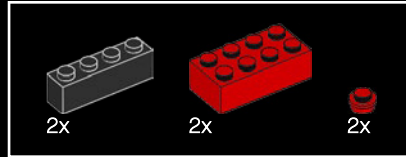
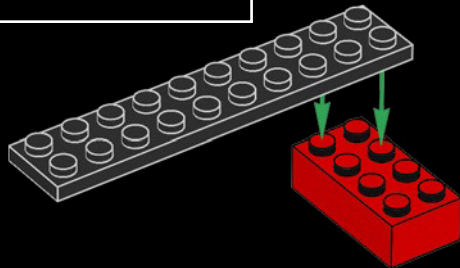

126

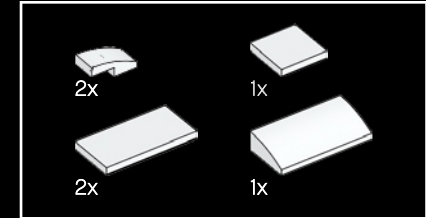
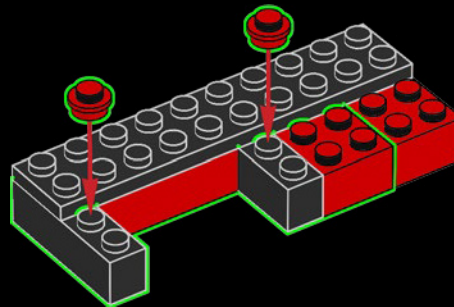

127

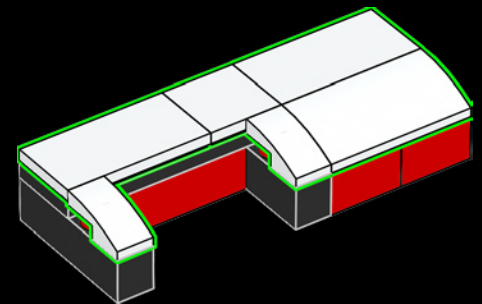

128

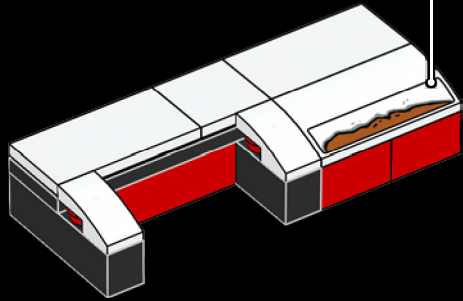

129

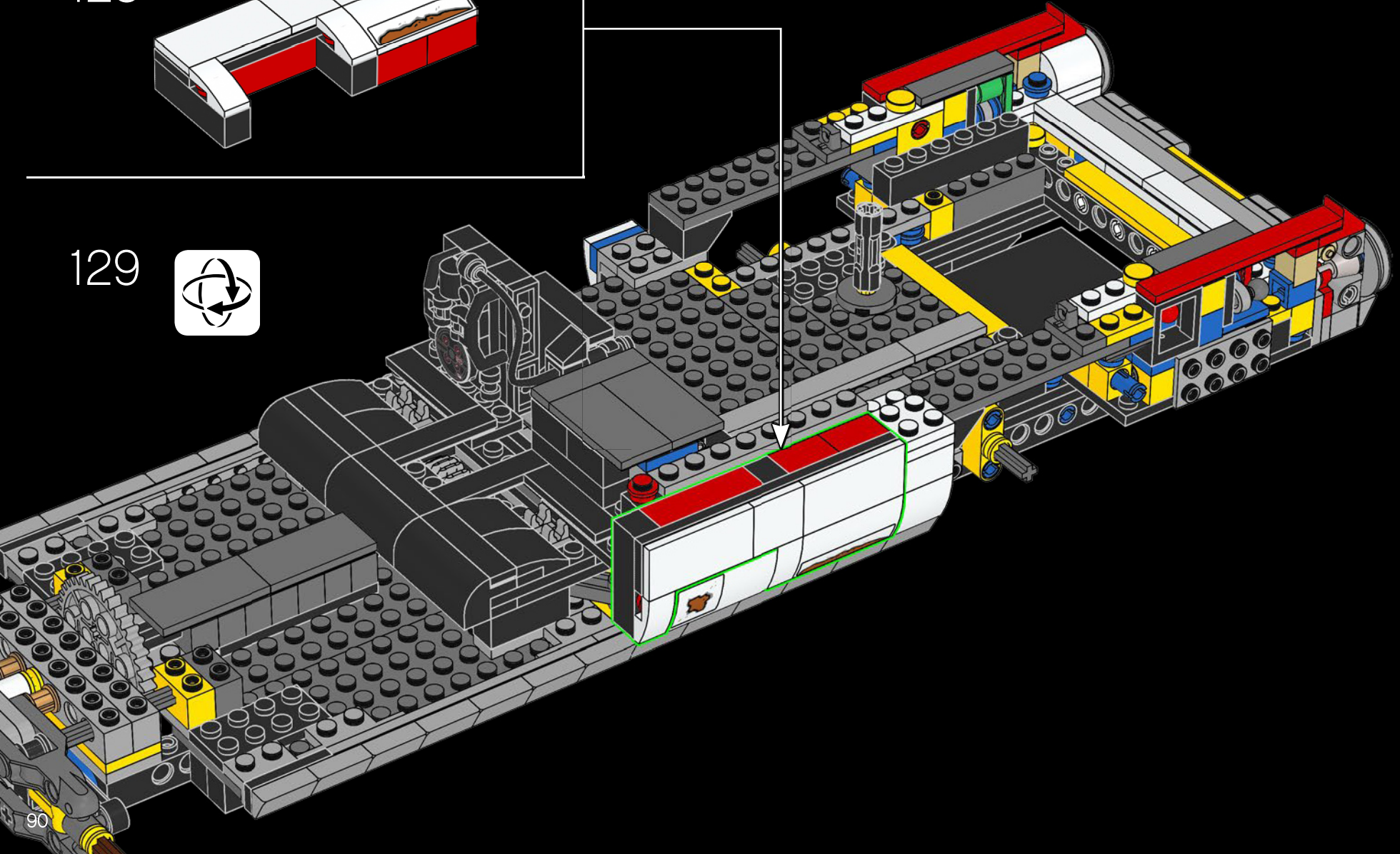

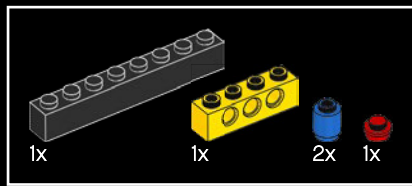

130

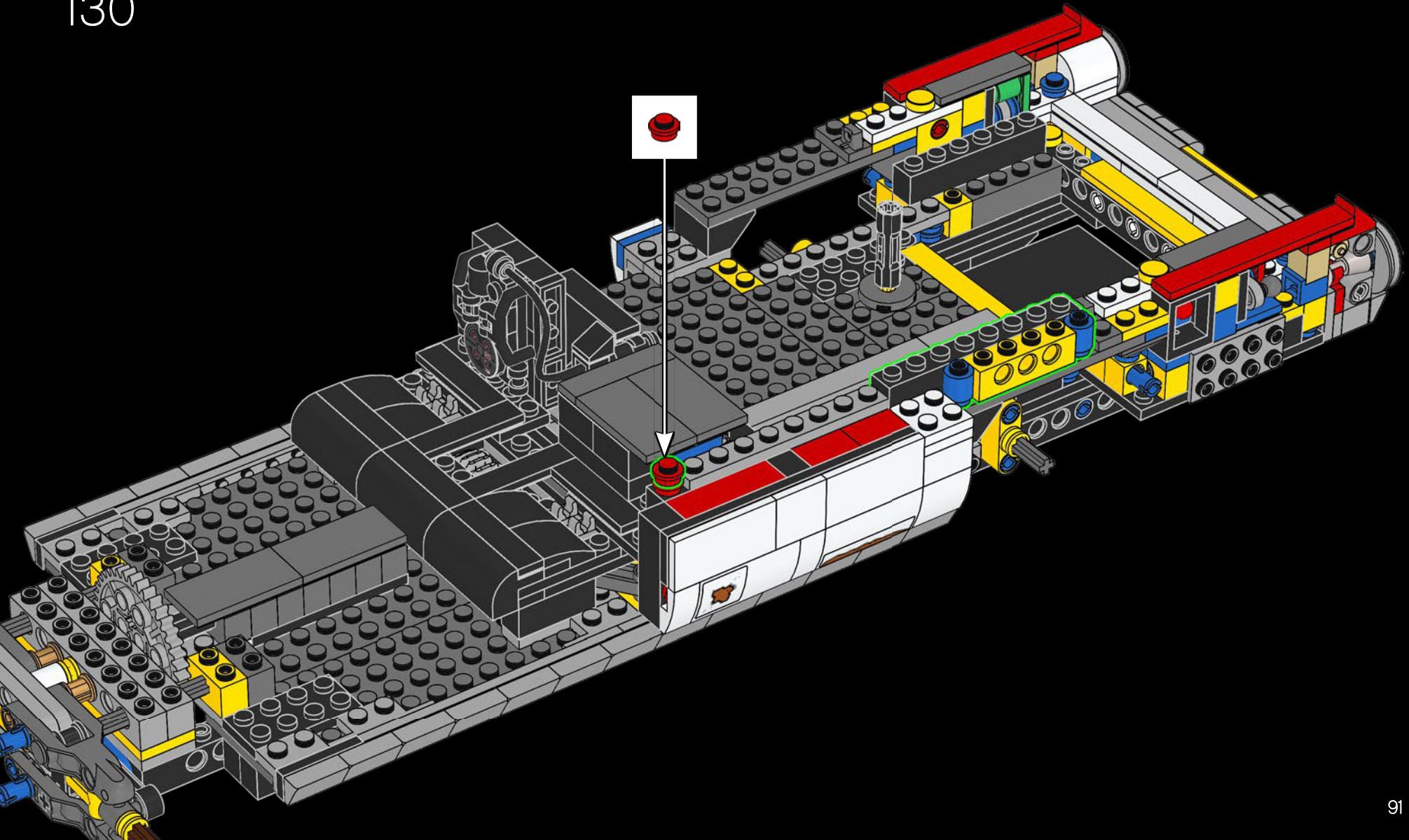

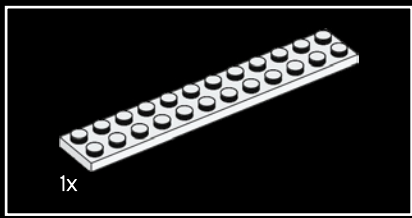

131

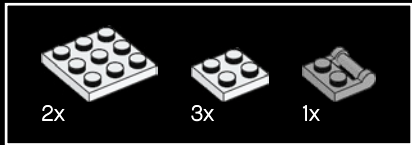
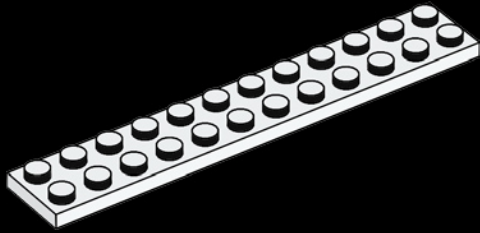

132

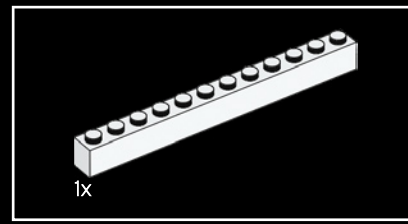
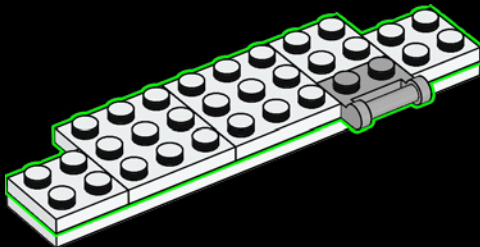

133

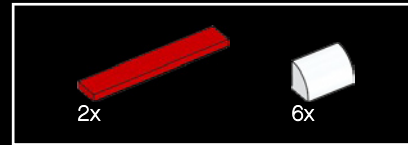
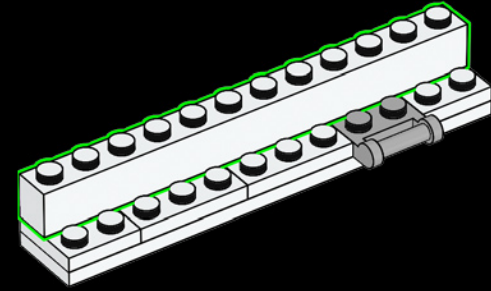

134

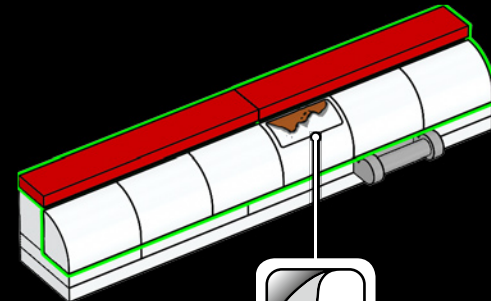

135

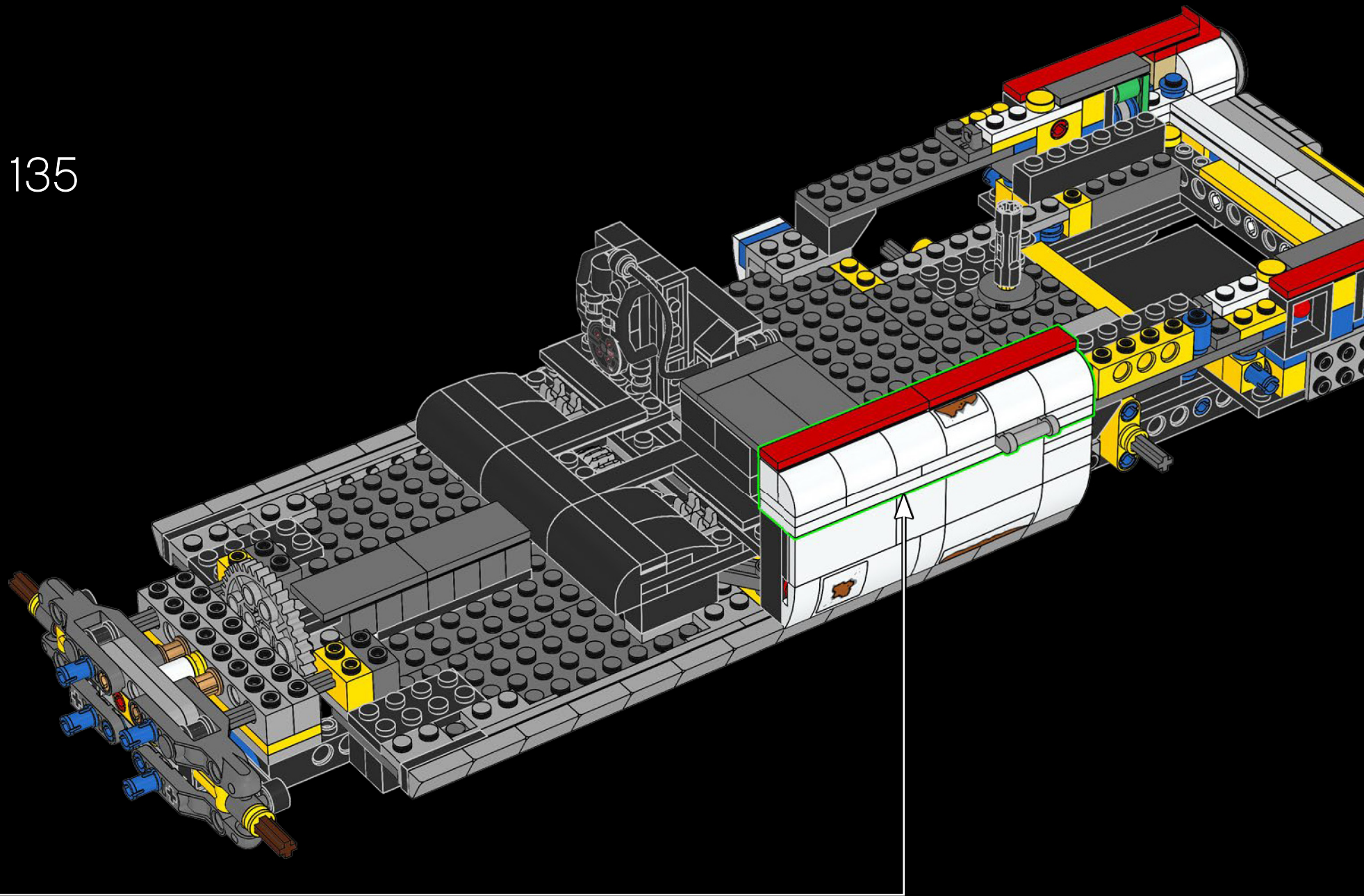

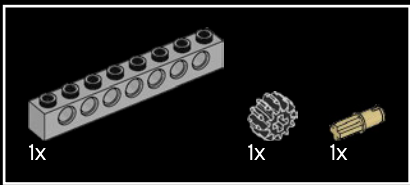

136

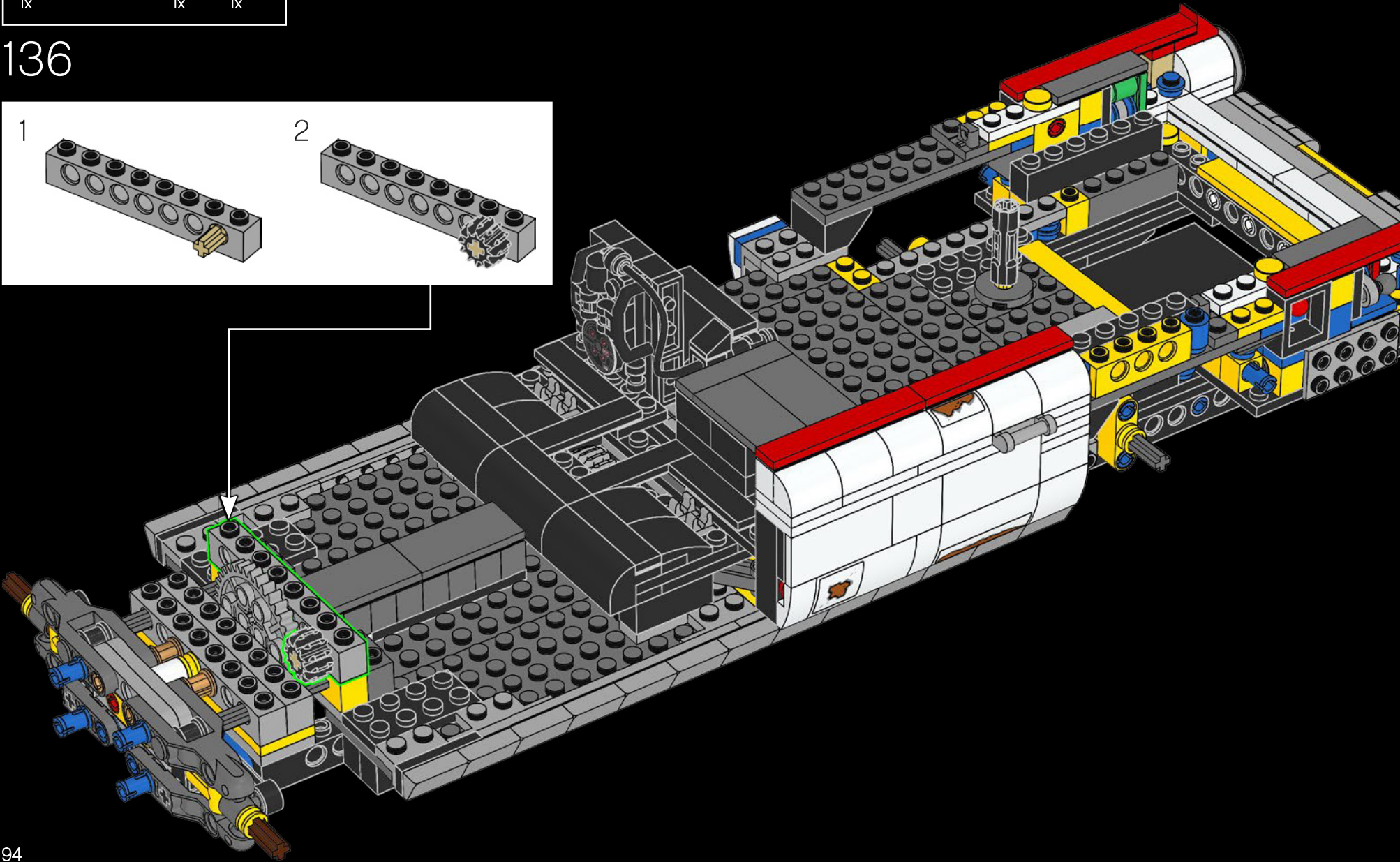
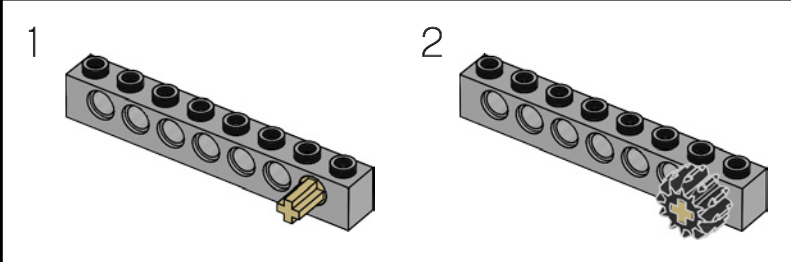

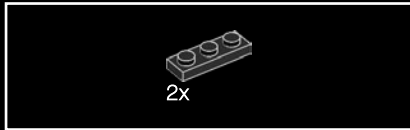

137

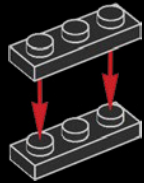

138

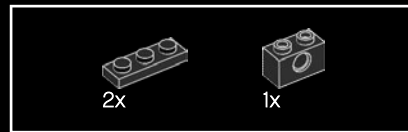
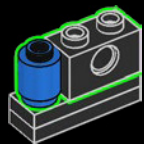

139

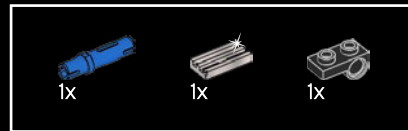
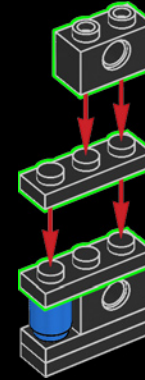

140

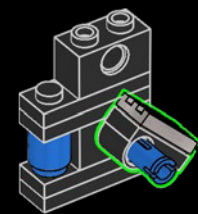
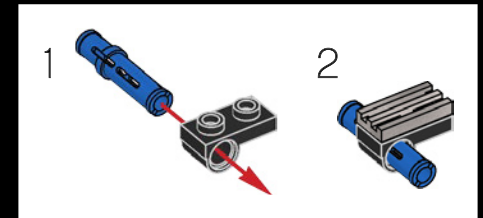

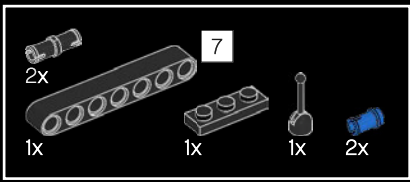

141

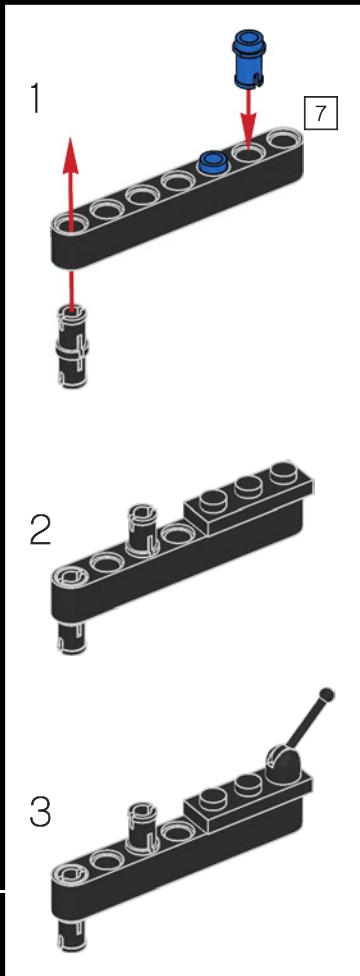
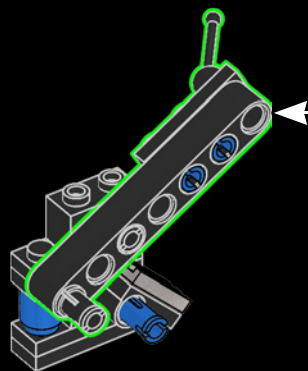

142

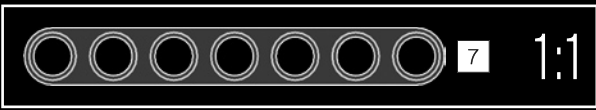
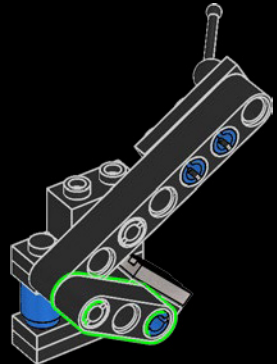



143

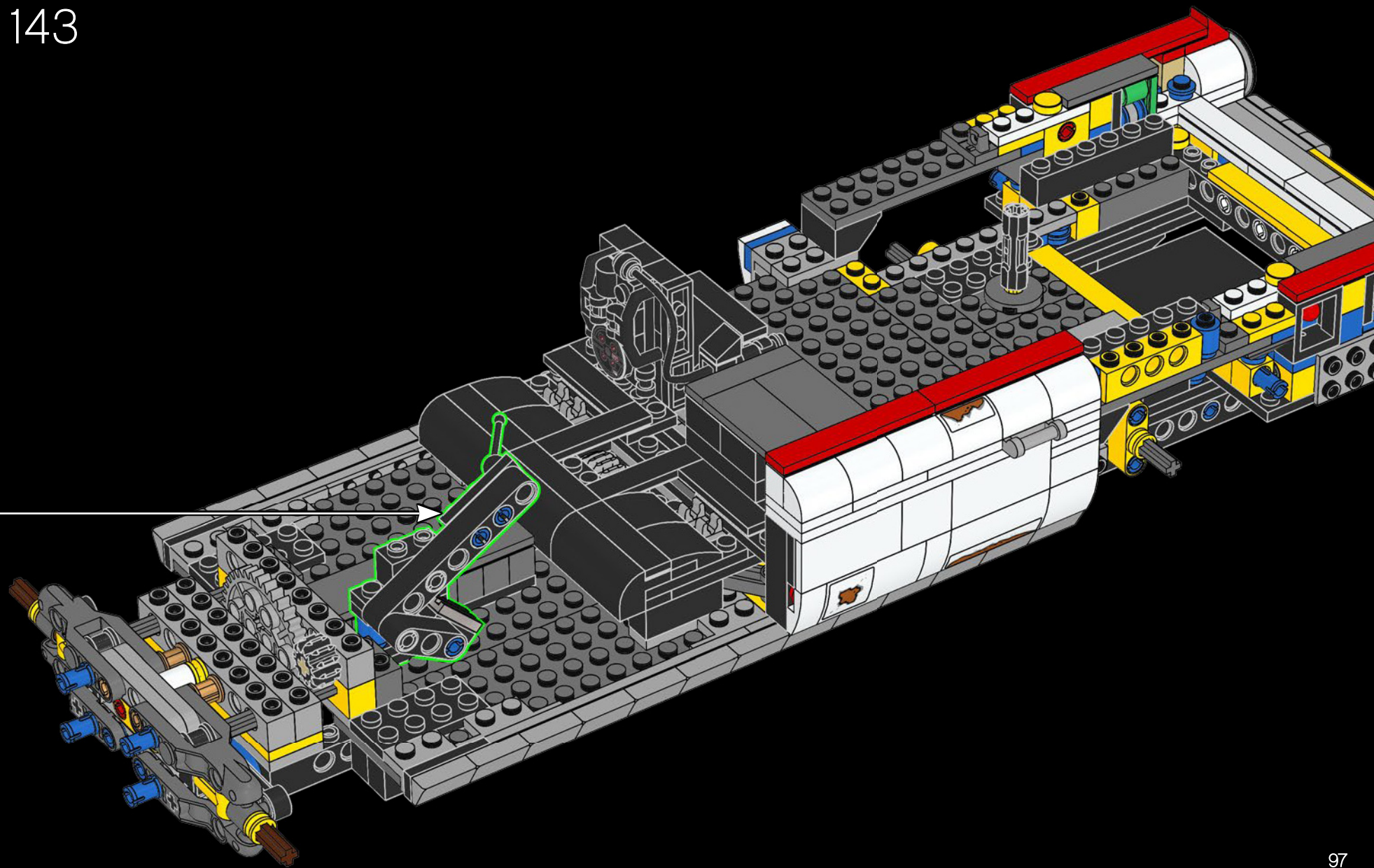

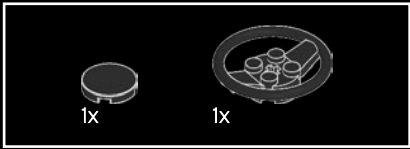
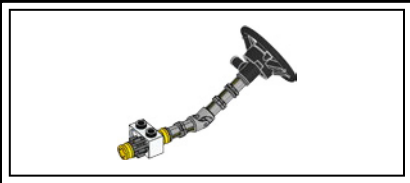

144

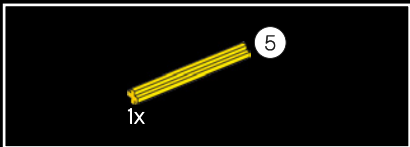
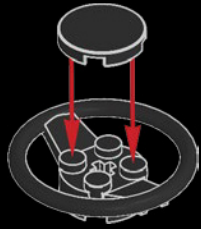

145

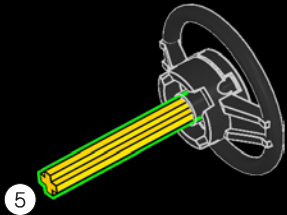

146

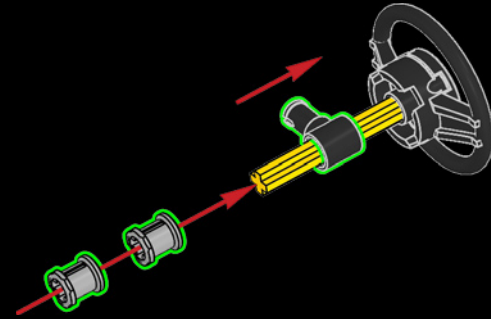

147

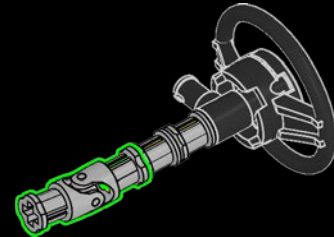

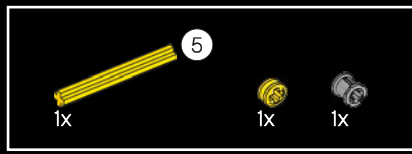

148

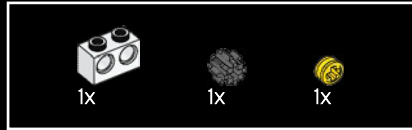
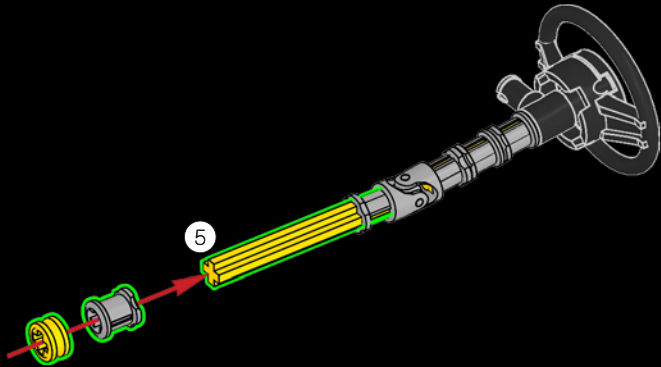

149

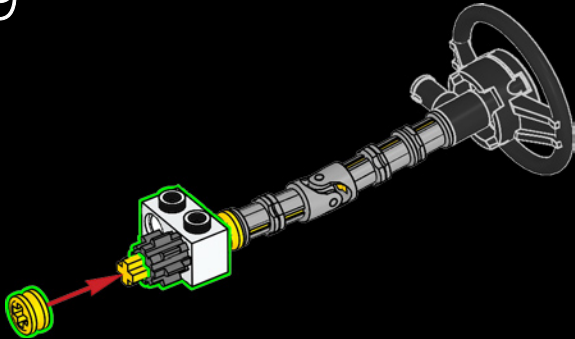

150

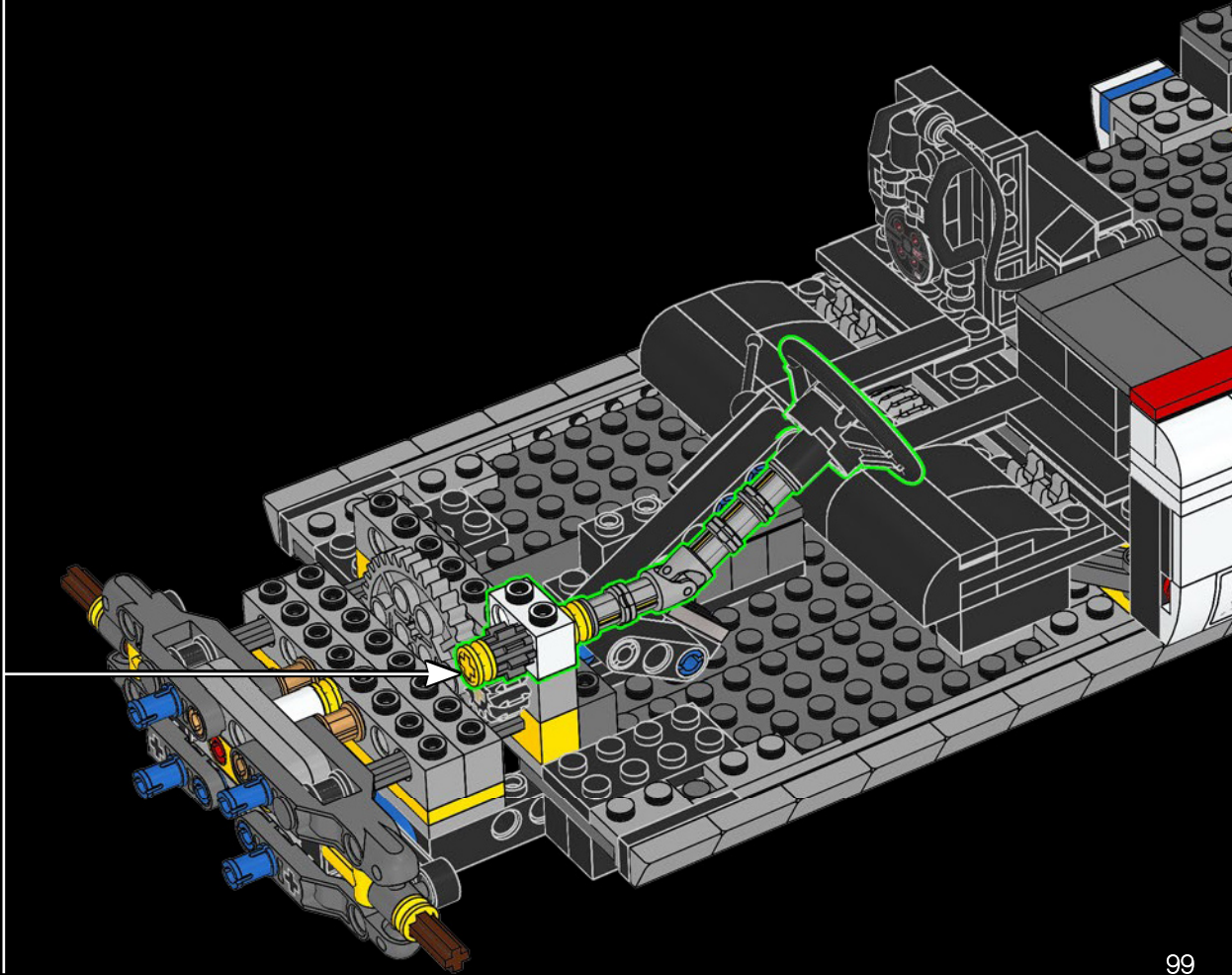

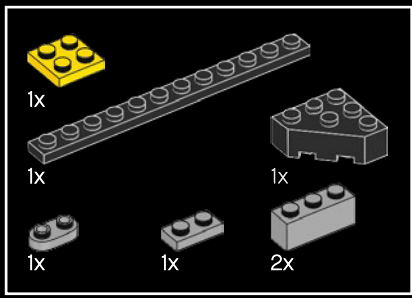

151

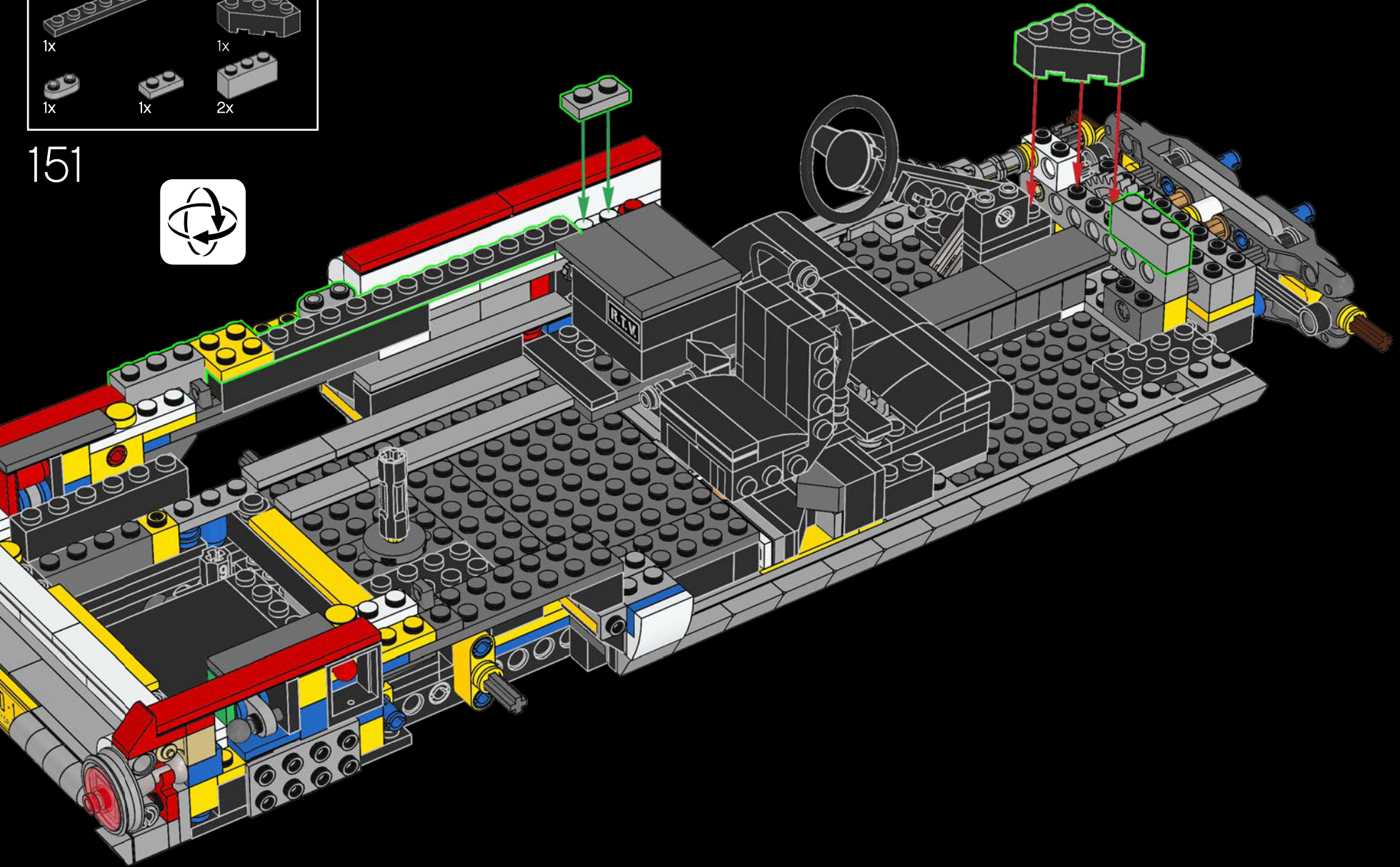

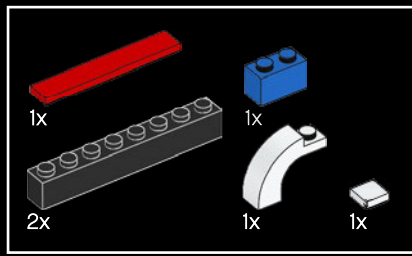

152

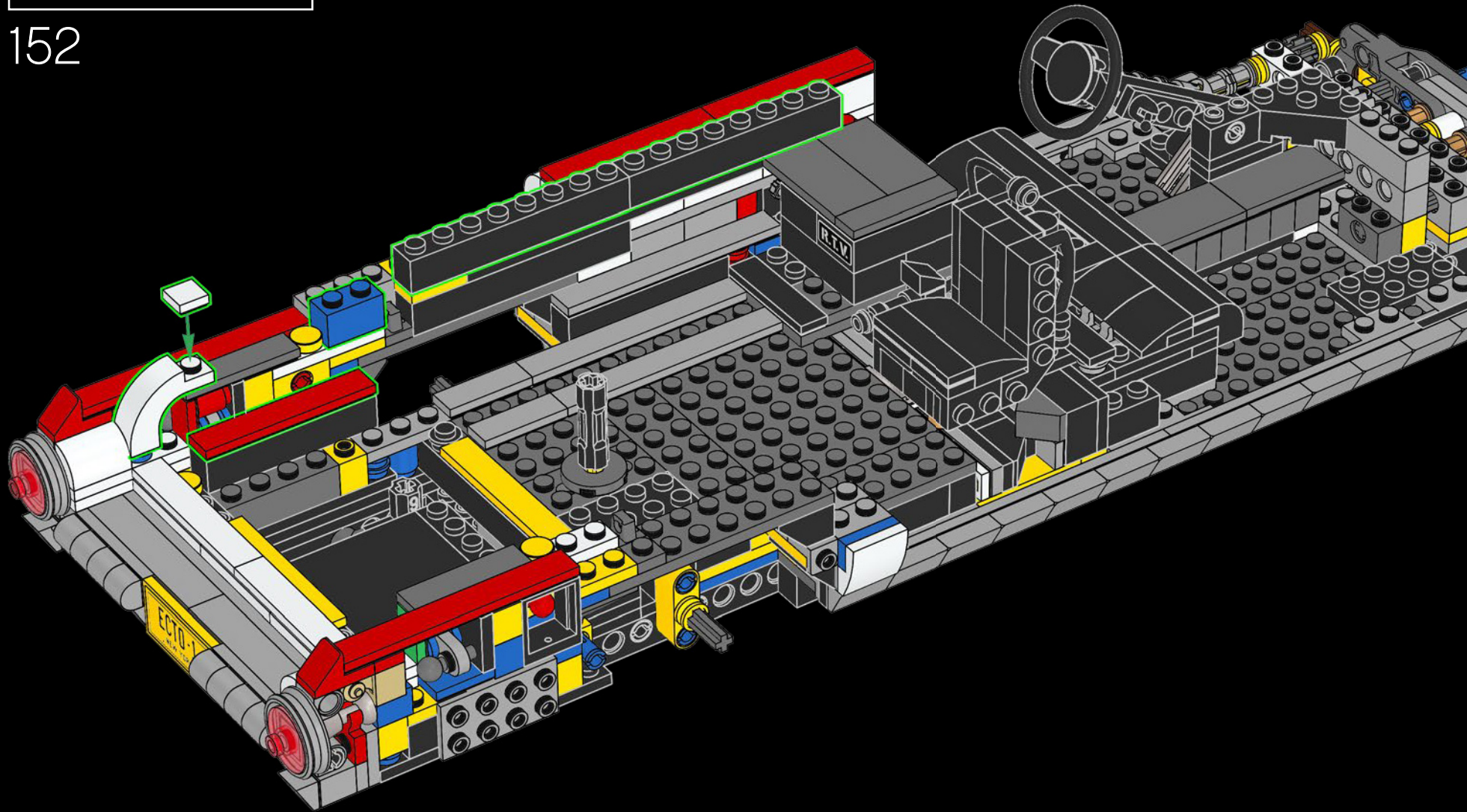

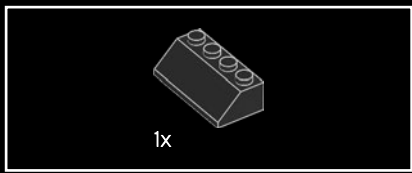

153

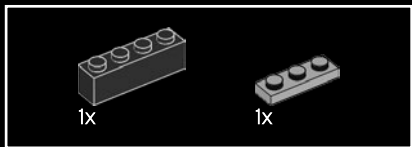
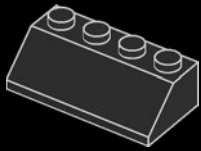

154

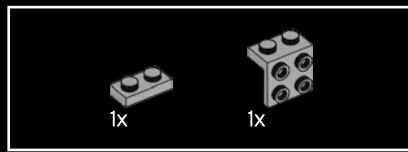
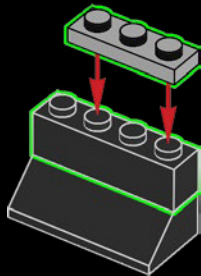

155

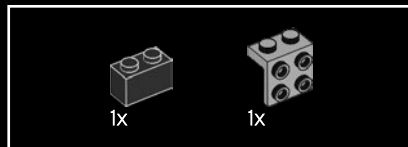
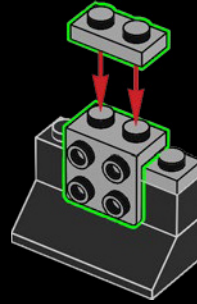

156

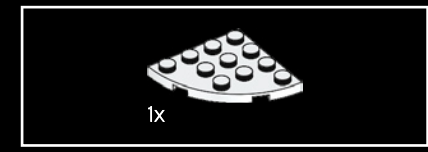
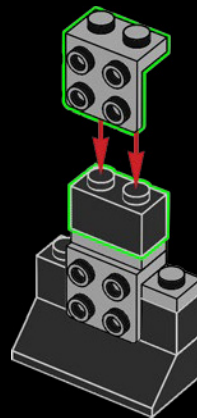

157

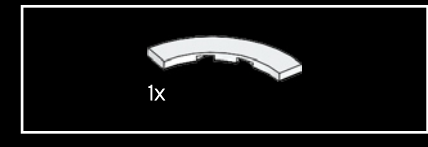
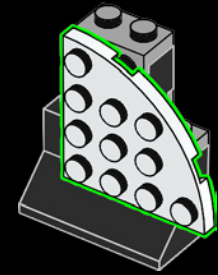

158

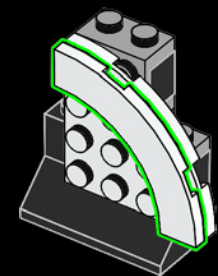

159

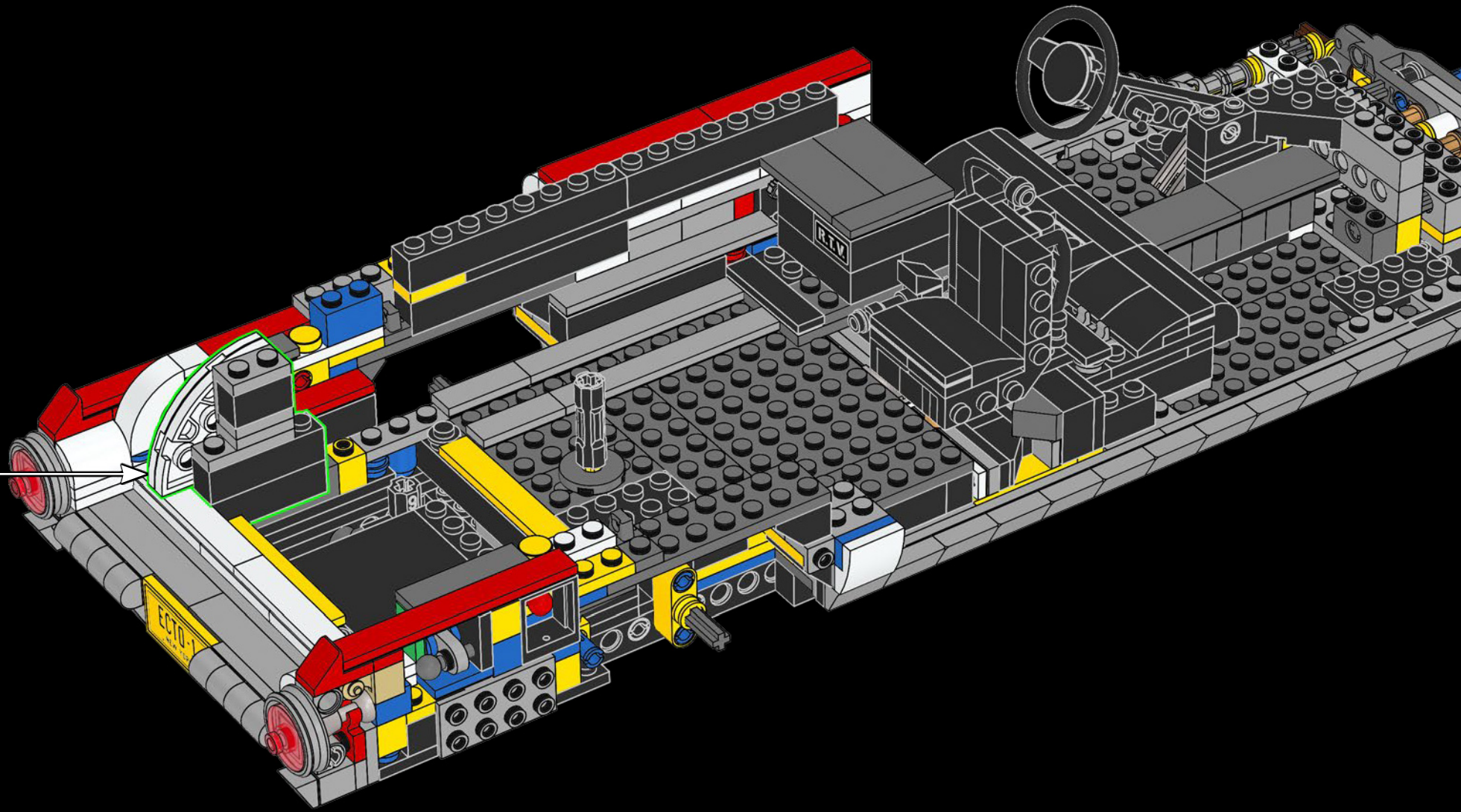

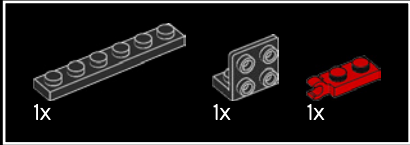
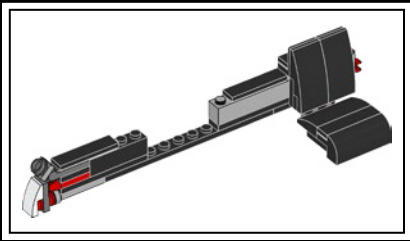

160

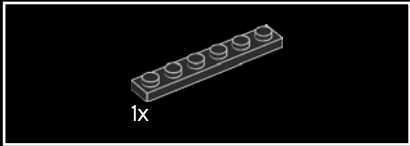

161

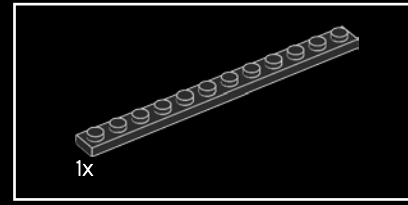
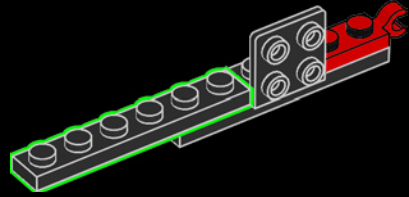
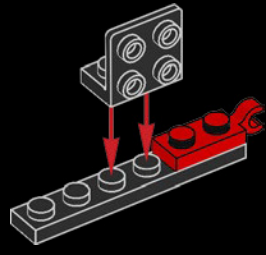

162

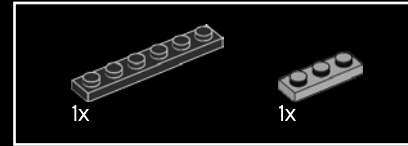
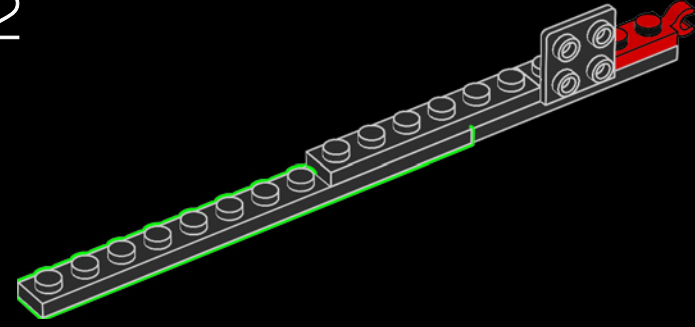

163

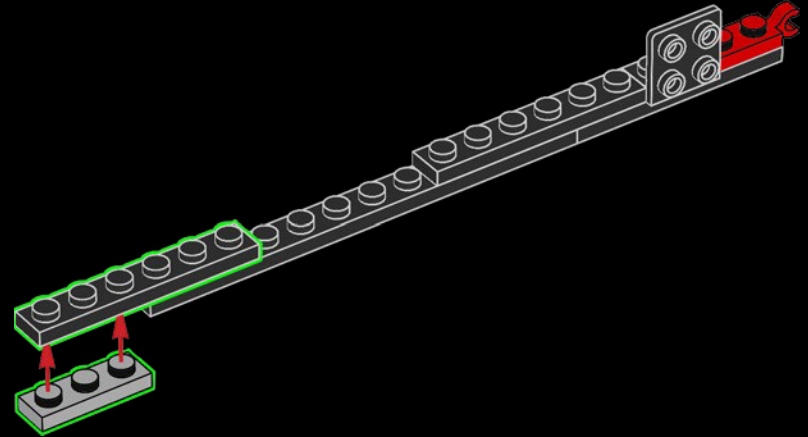



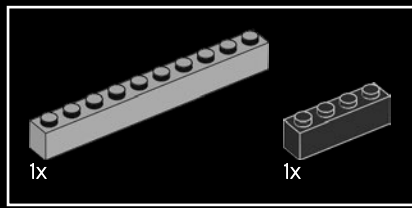

164

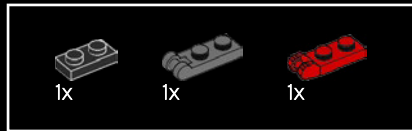
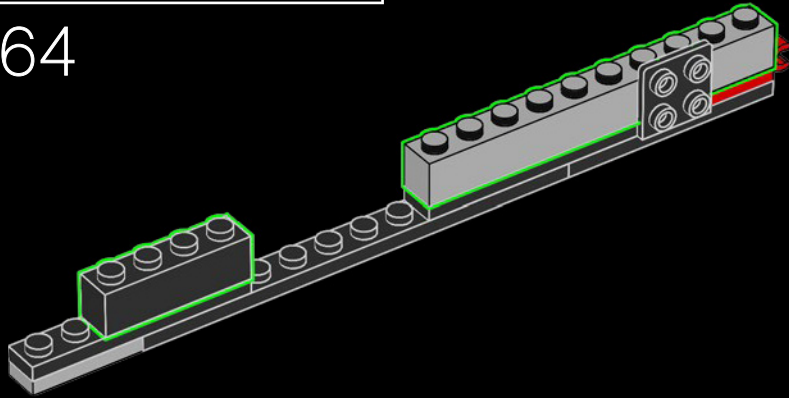

165

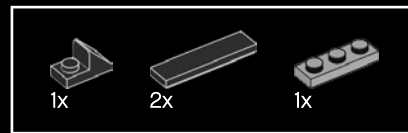
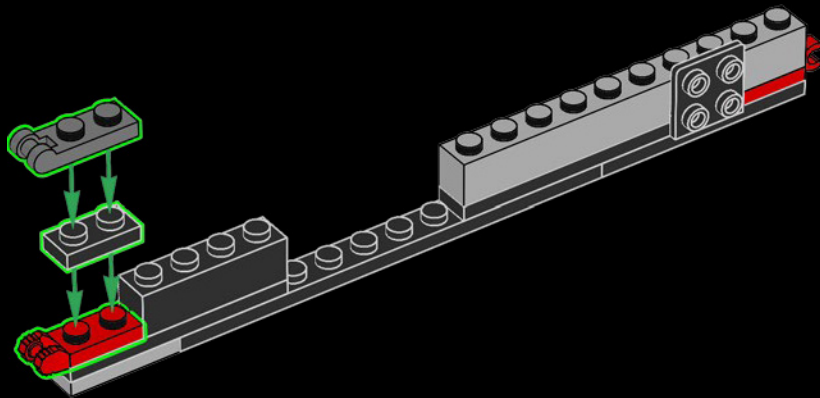

166

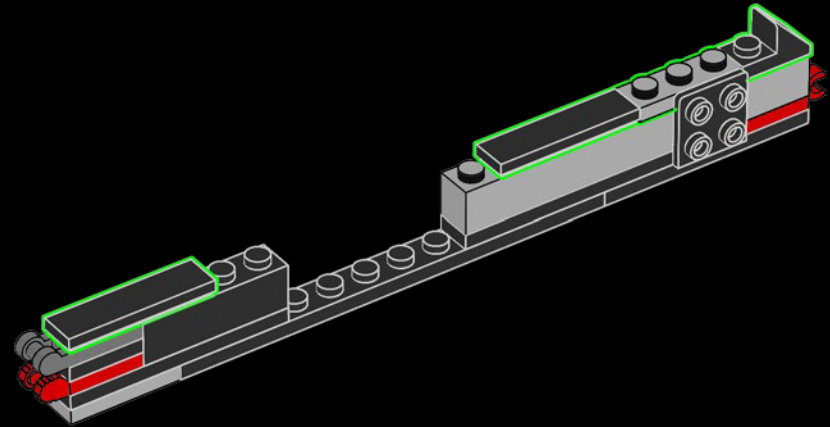

167

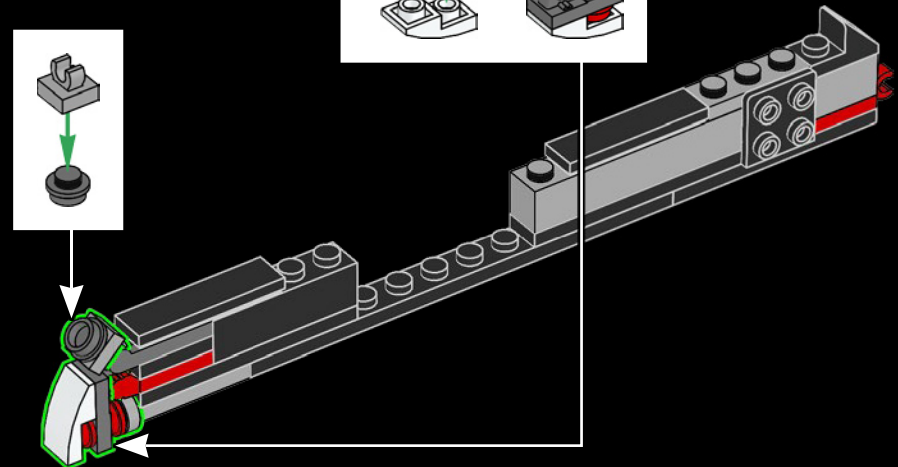
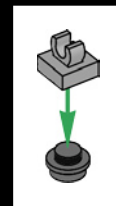
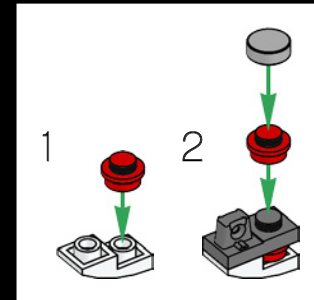



168

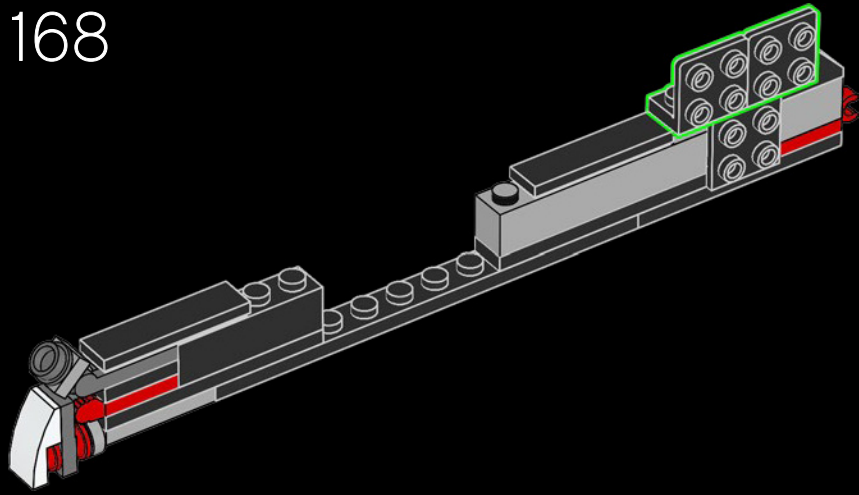

170

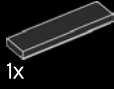
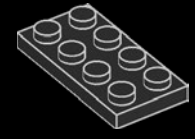
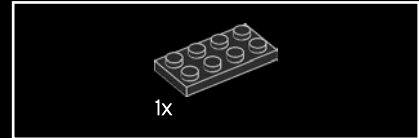

169

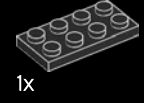
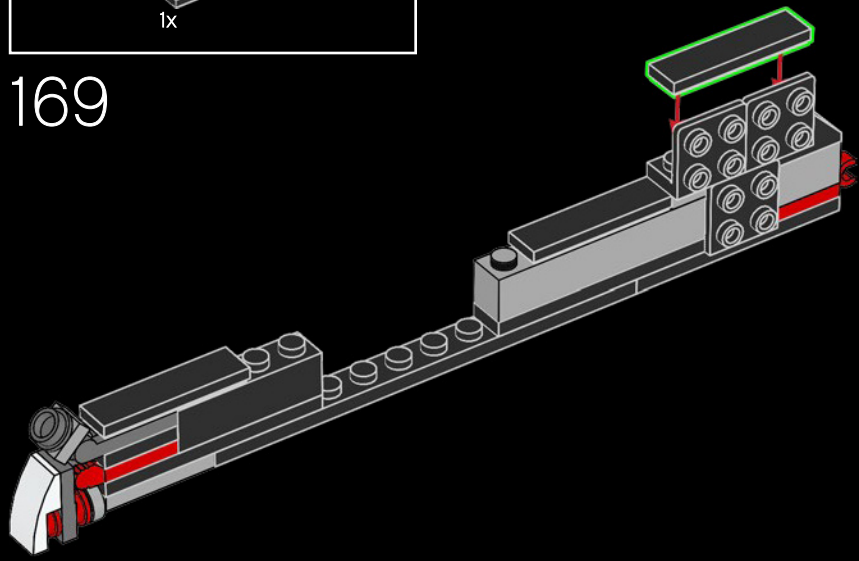

171

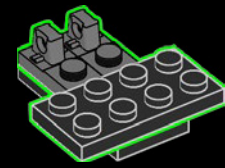
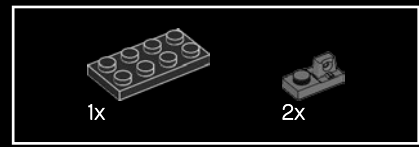

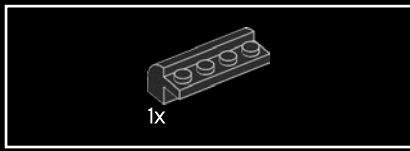

172

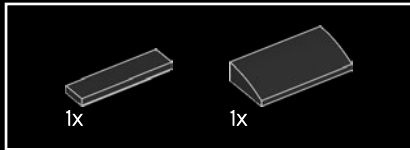
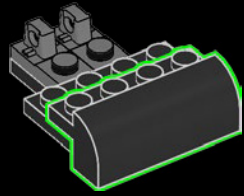

173

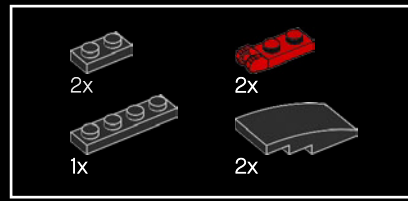
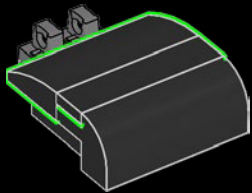

174

- 1
- 2
- 3
- 4

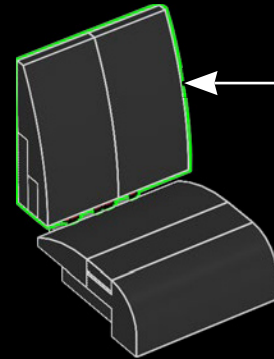

175

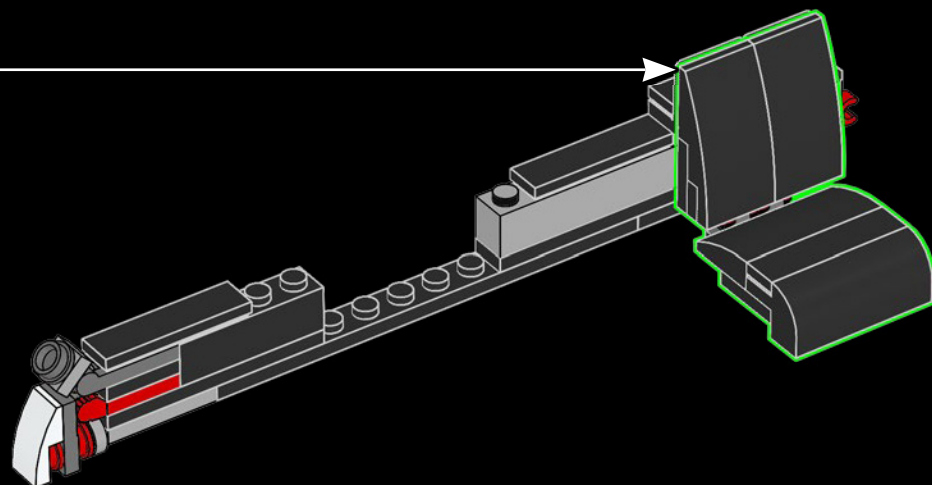

176

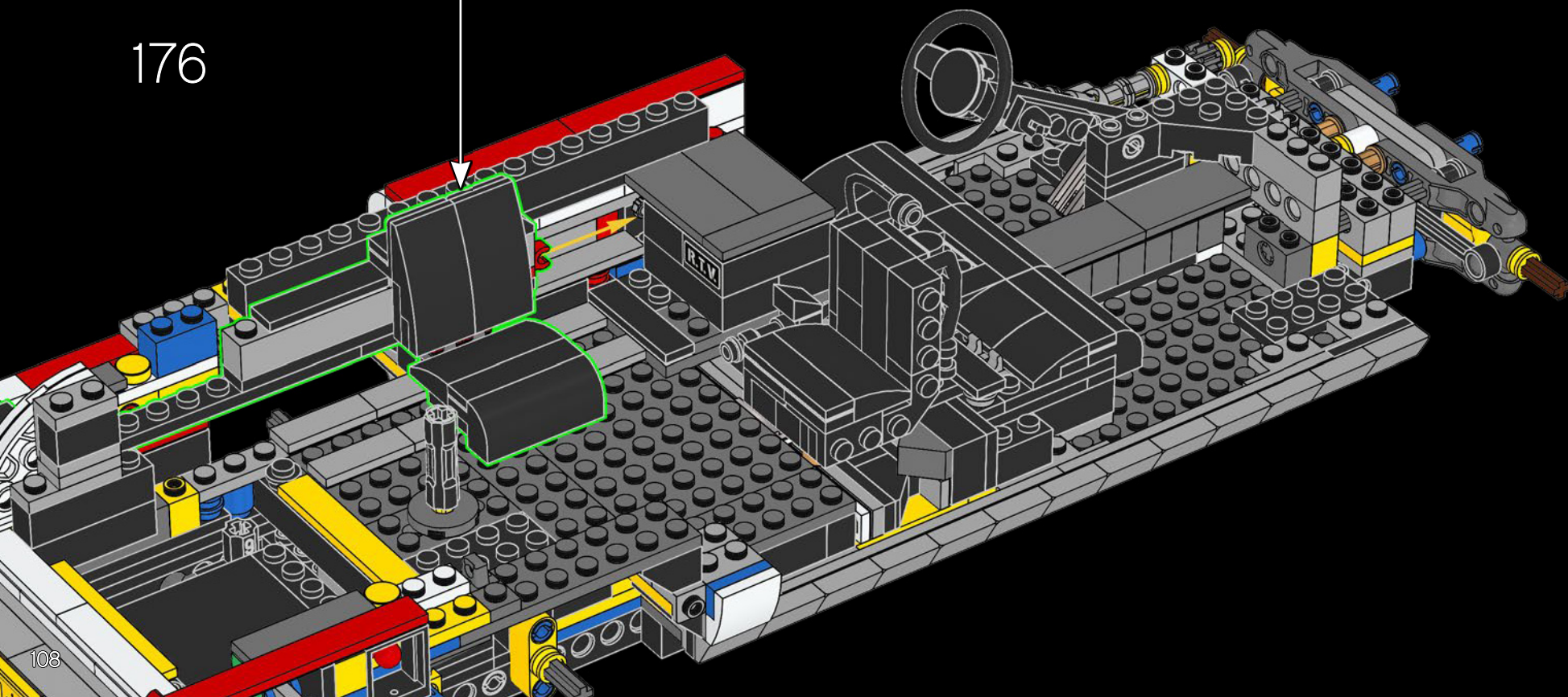

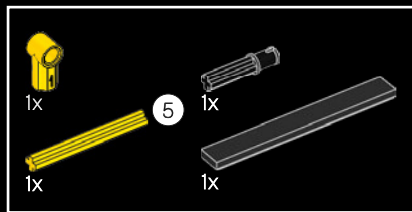

177

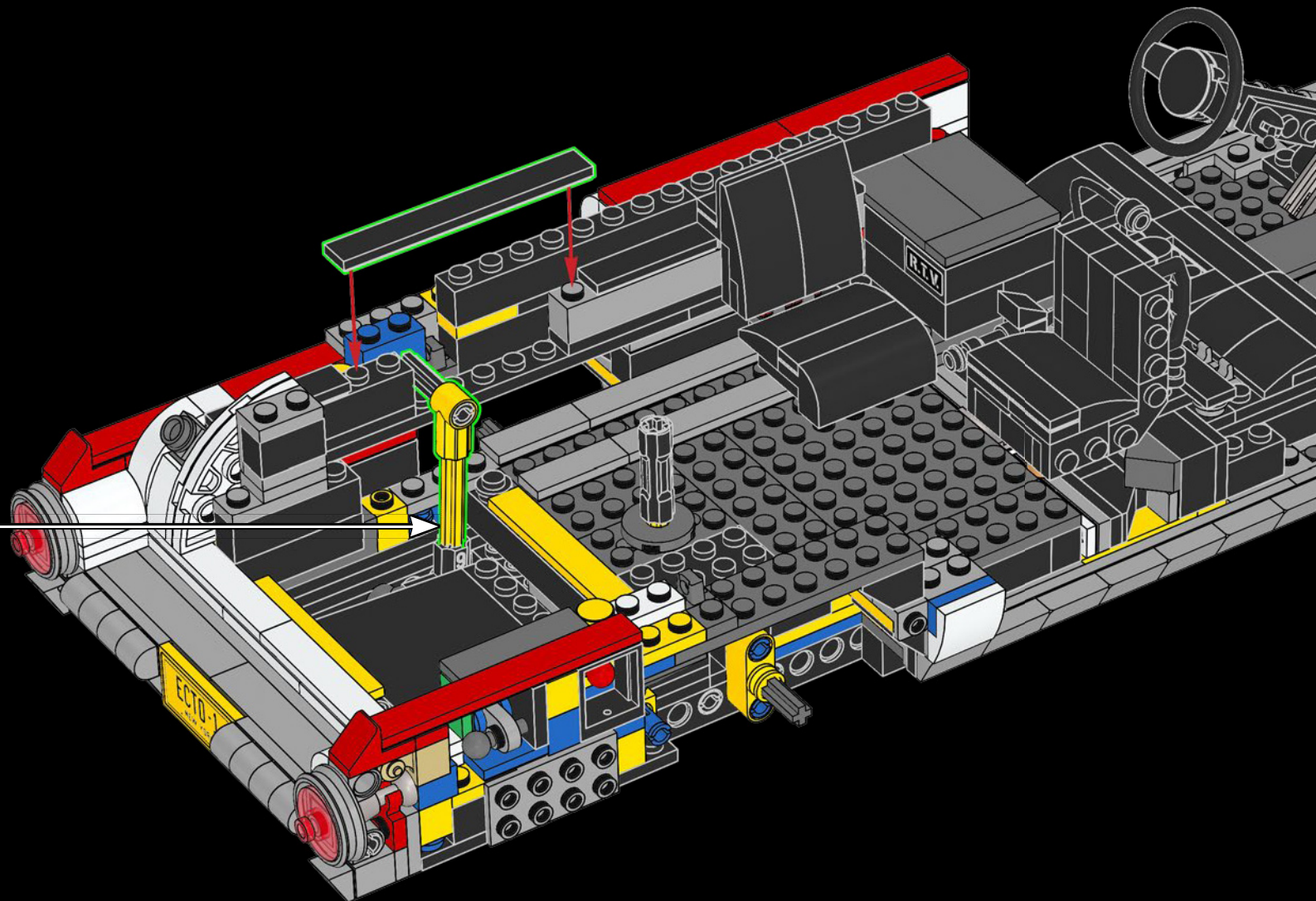
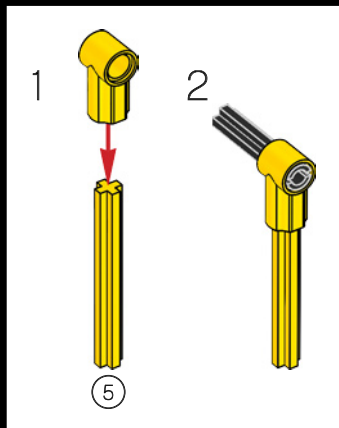

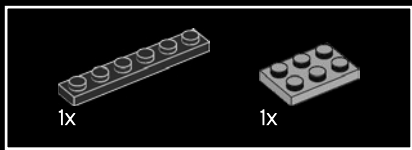

178

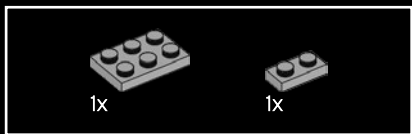
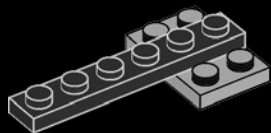

179

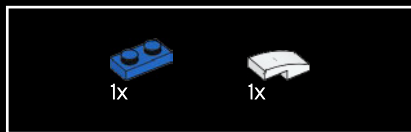
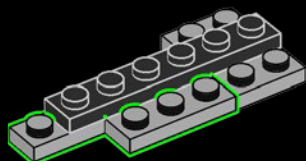

180

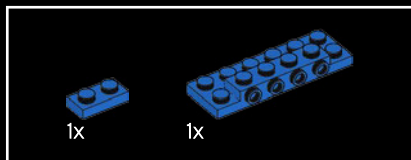
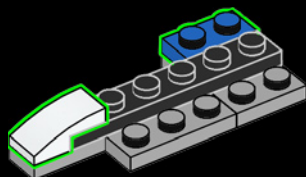

181

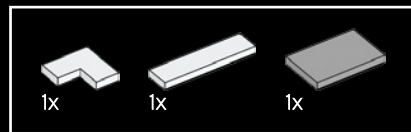
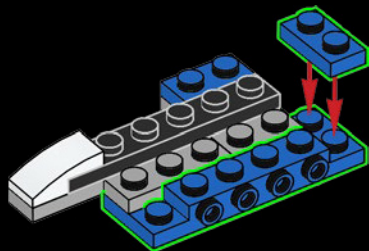

182

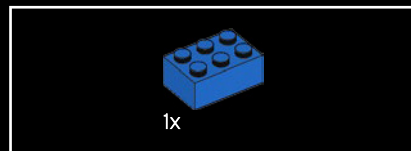
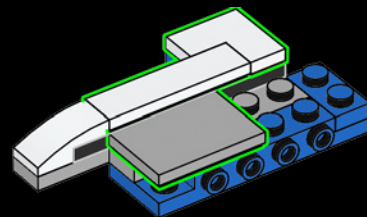

183

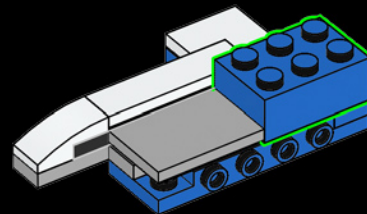

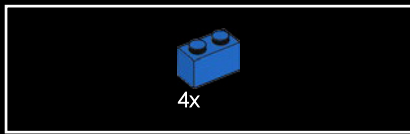

184

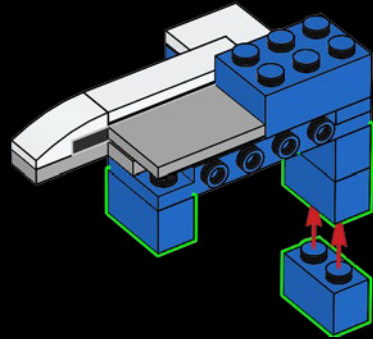

185

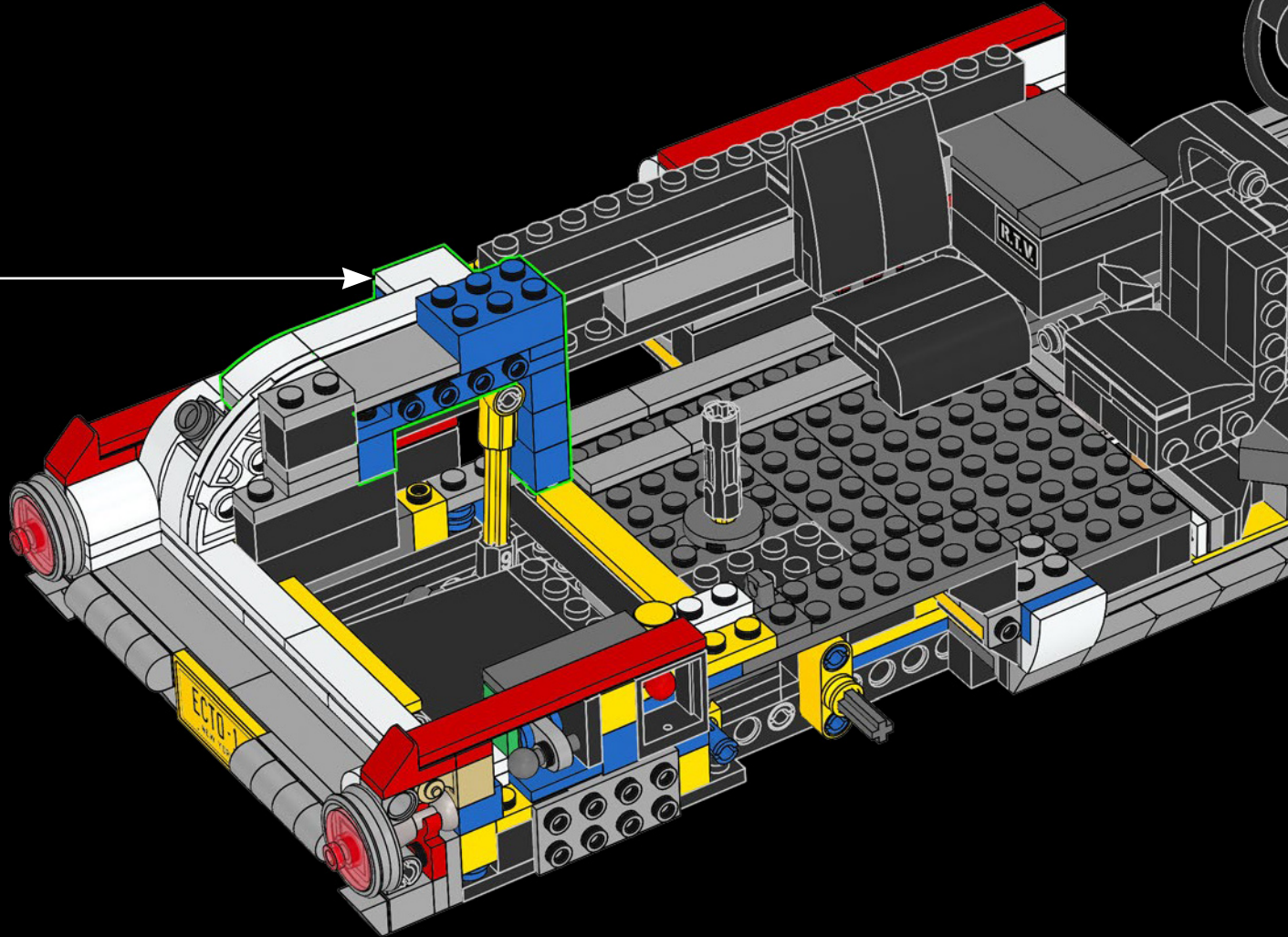

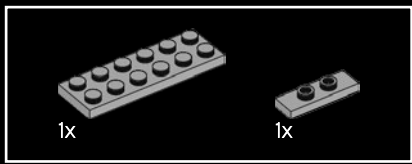

186

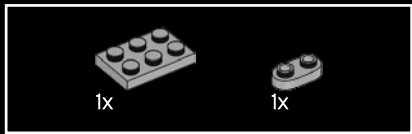
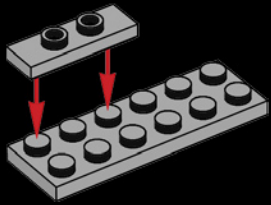

187

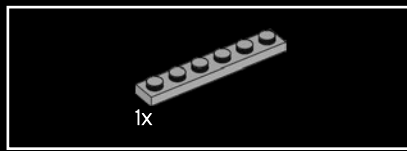
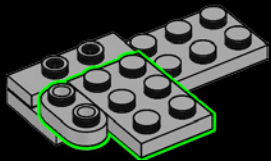

188

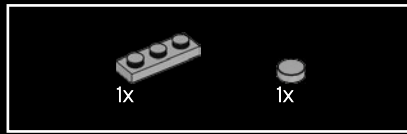
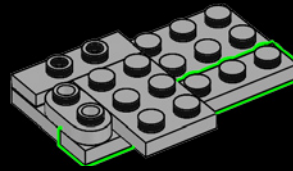

189

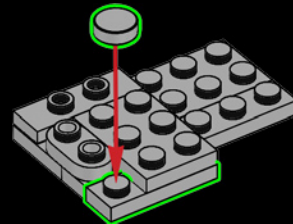

190

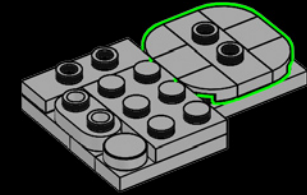

191





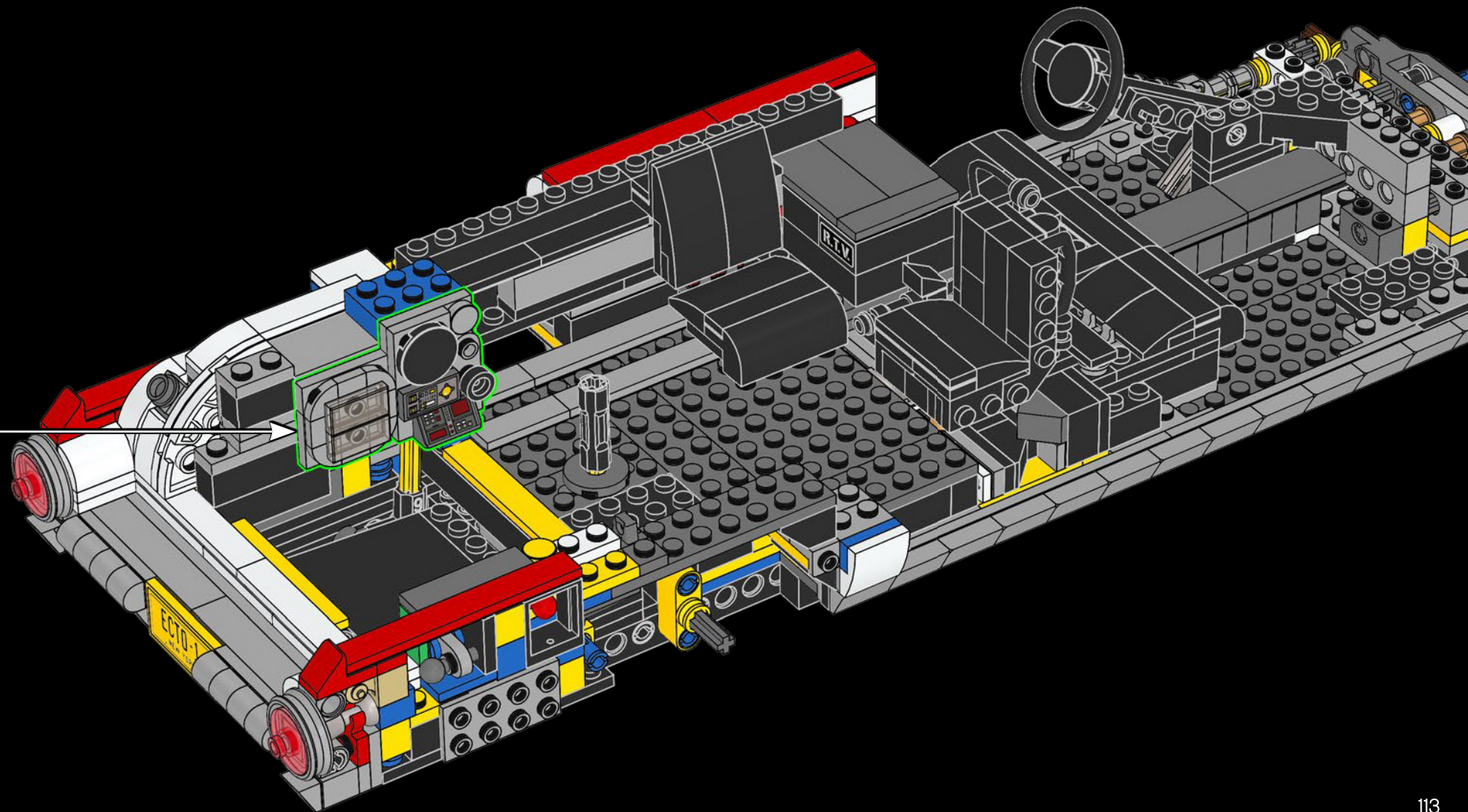

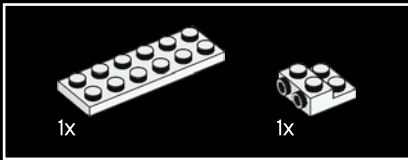
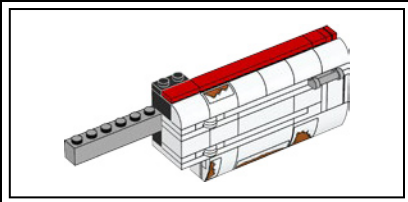
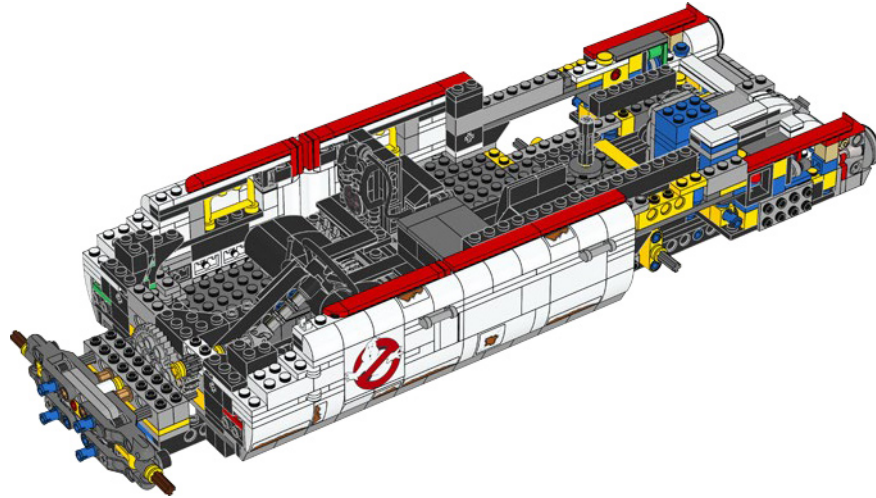
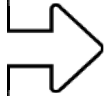

193

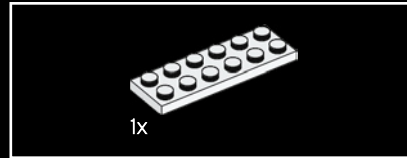
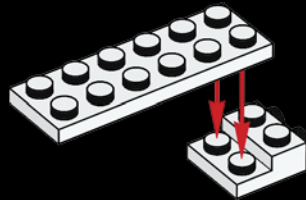

194

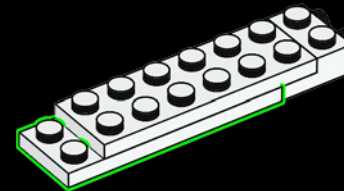

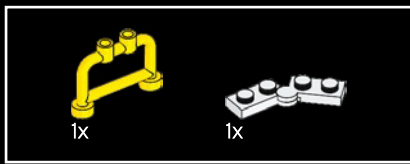

195

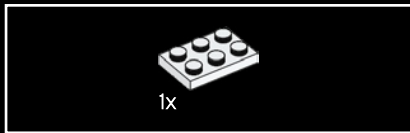
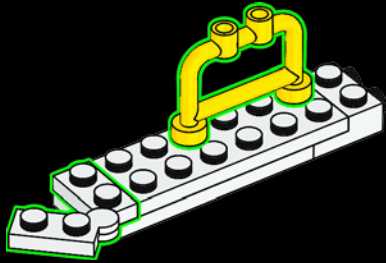

196

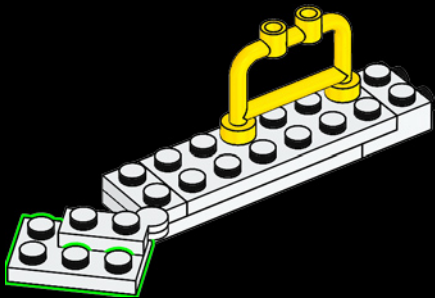

197

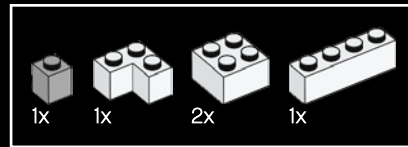
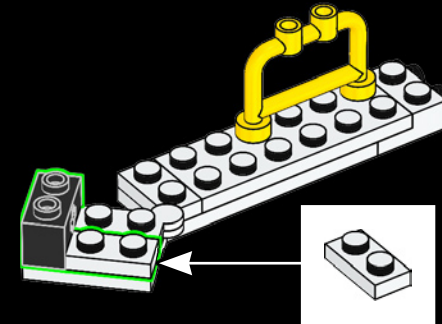

198

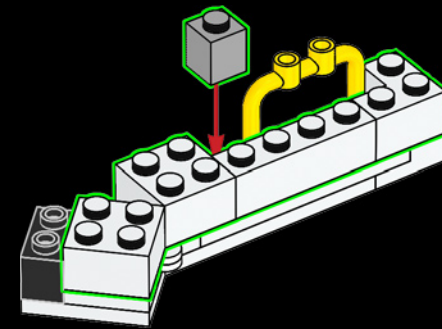

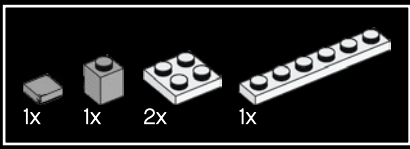

199

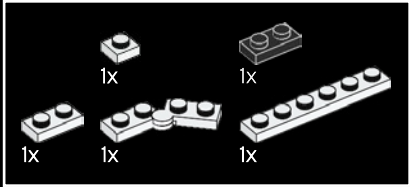
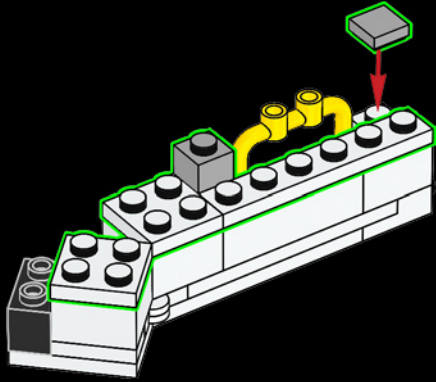

200

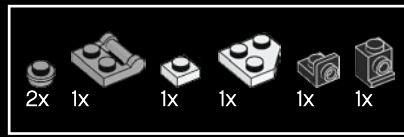
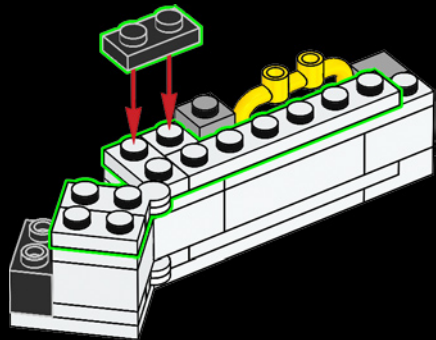

201

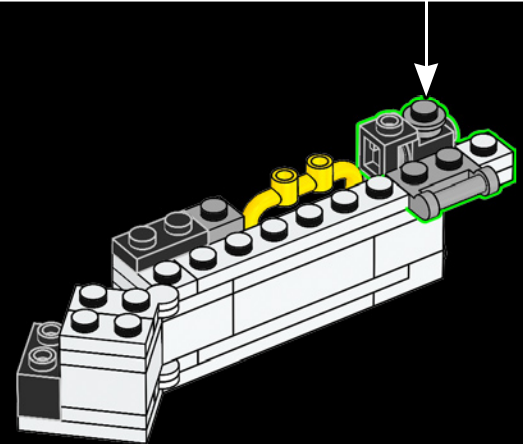
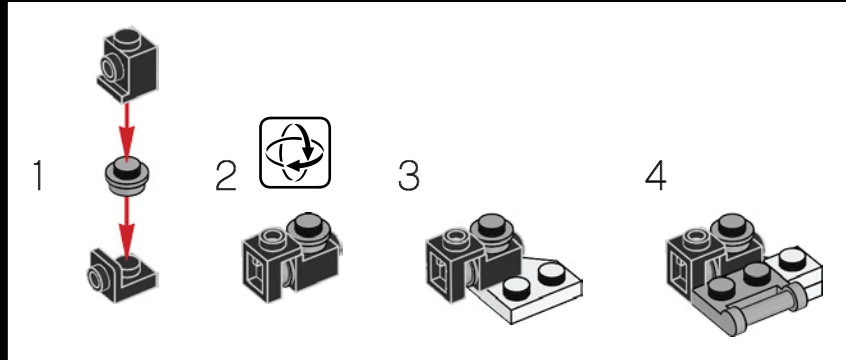

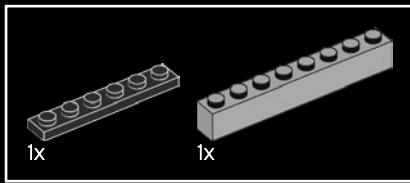

202

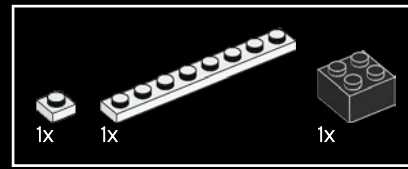
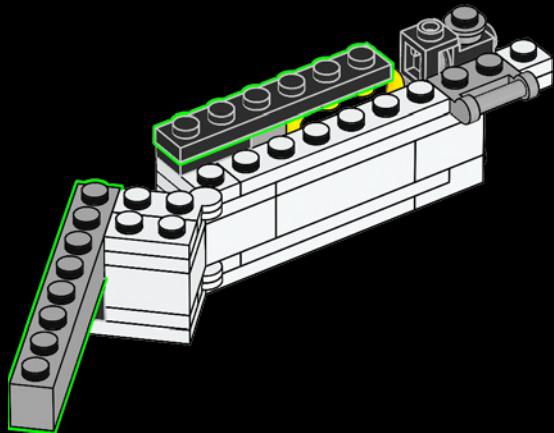

203

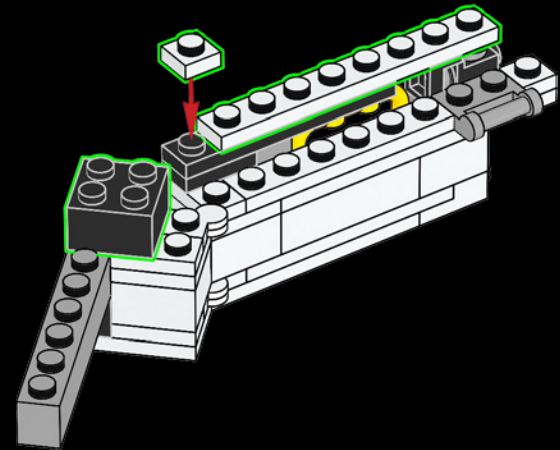

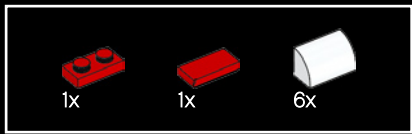

204

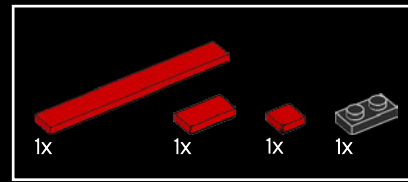
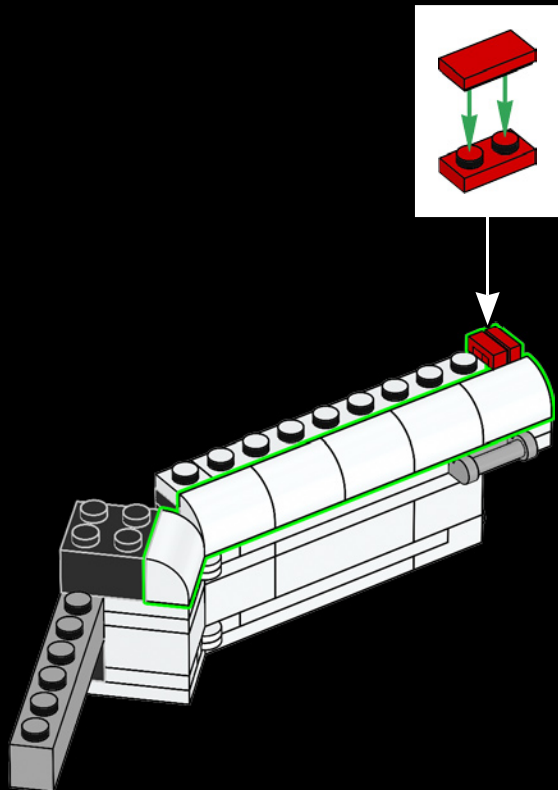

205

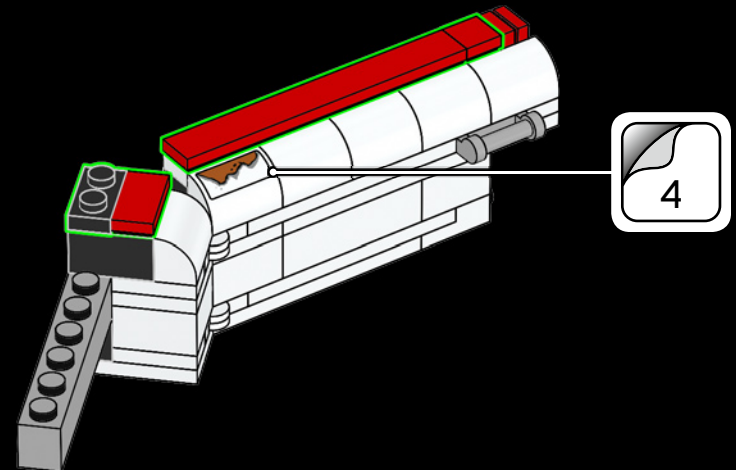

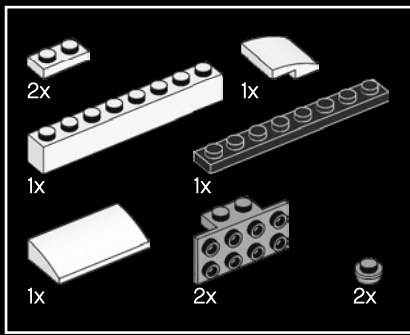

206

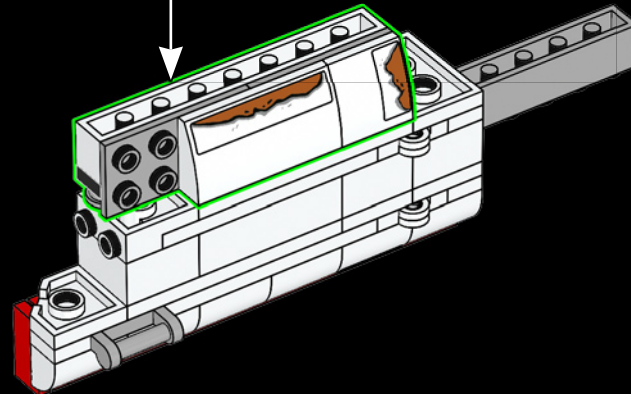
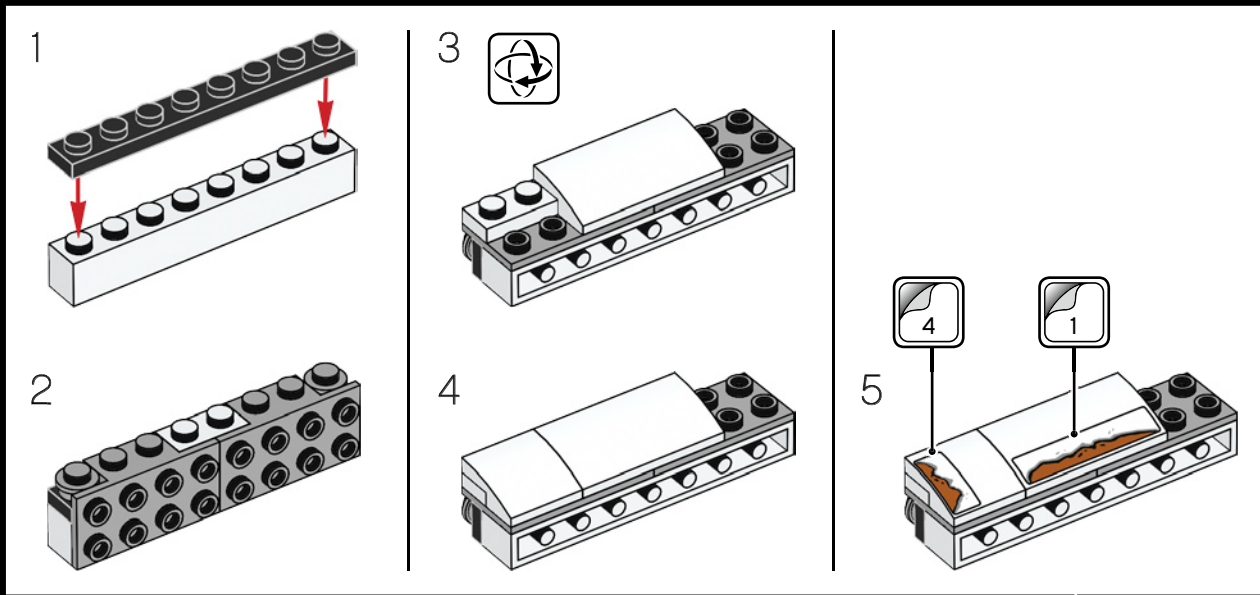

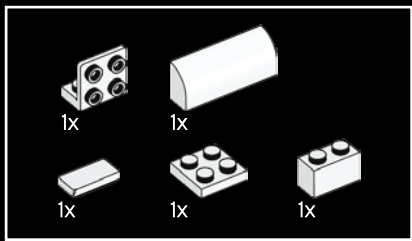

207

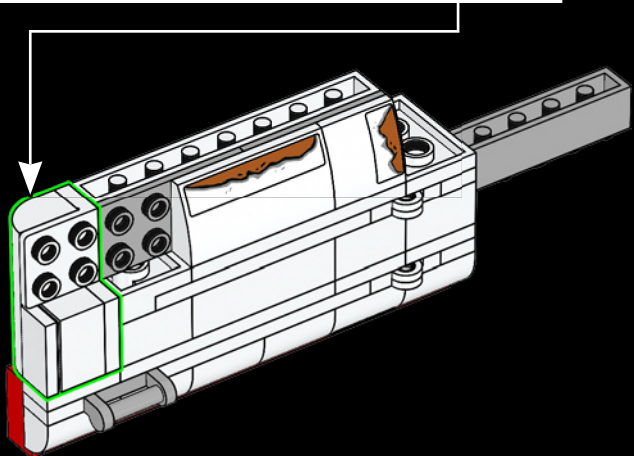
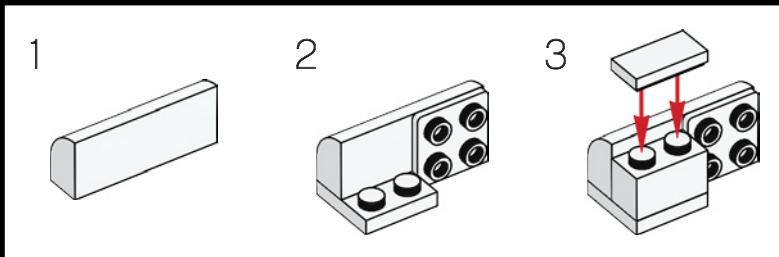

208

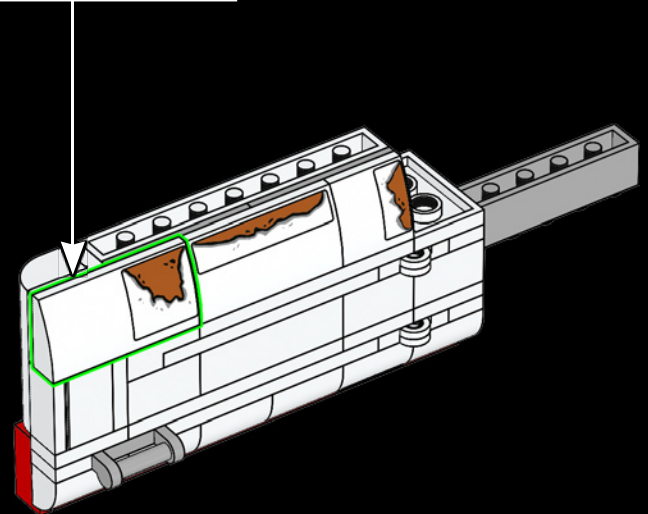
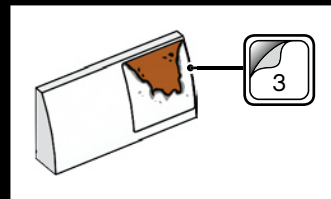



209

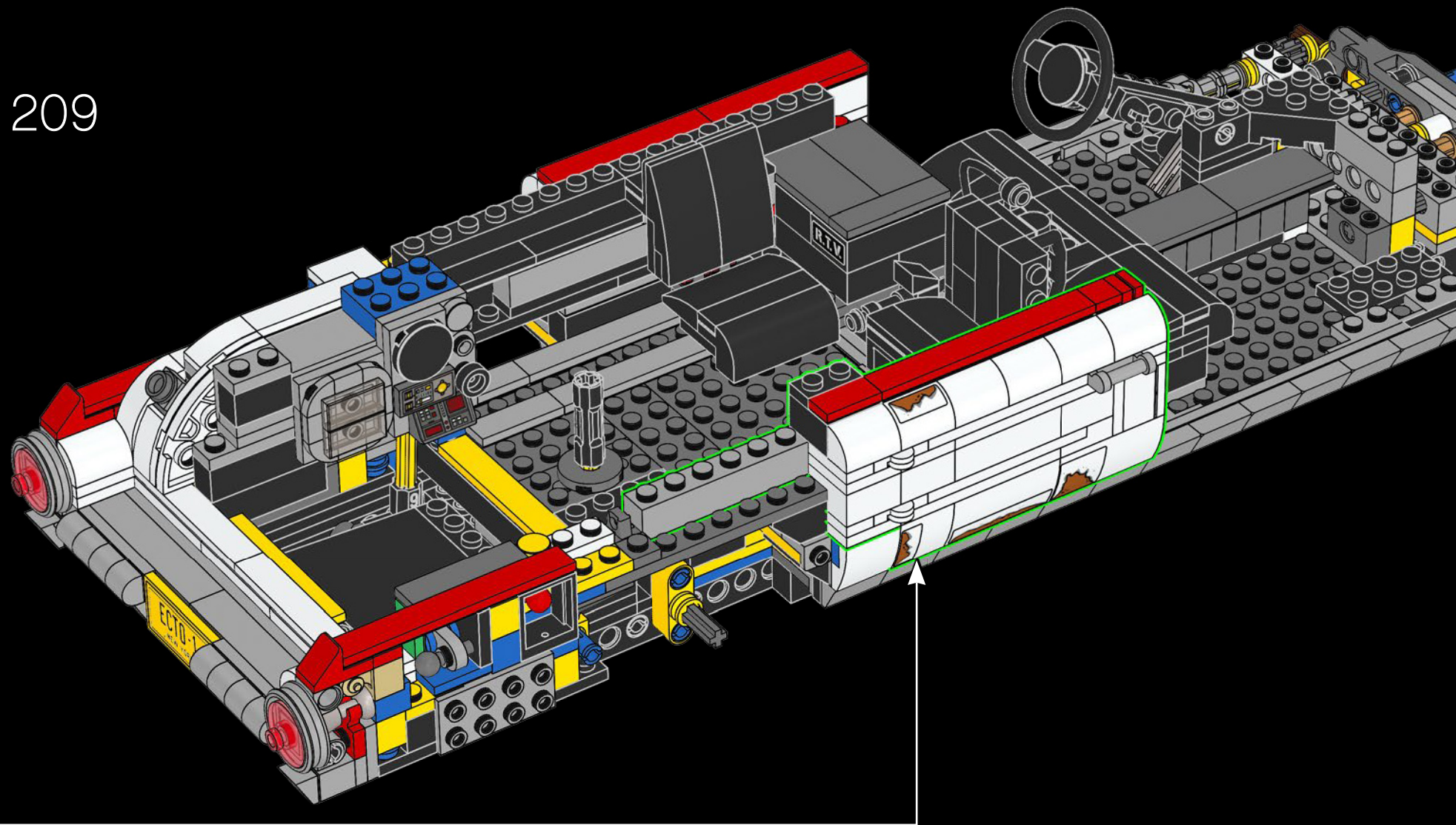

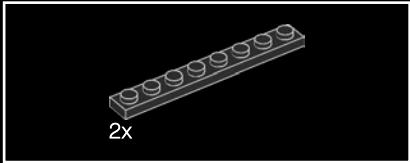
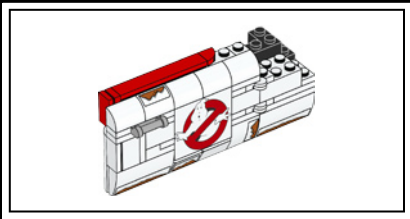

2x

210

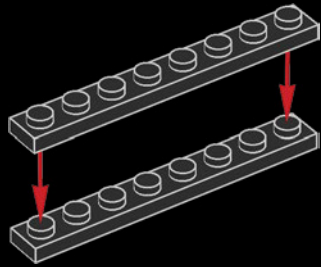

2x

2x

211

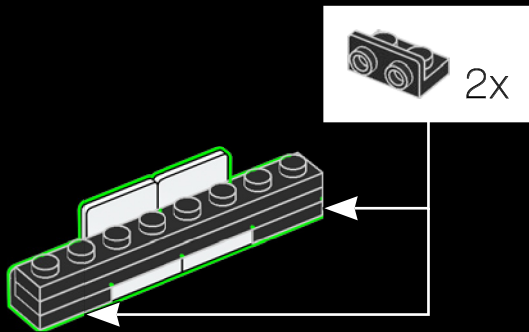

2x



2x

212

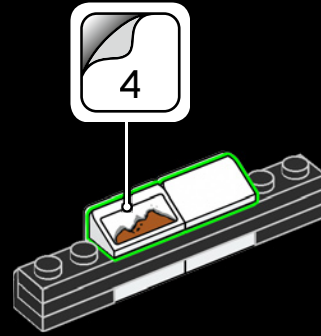

4

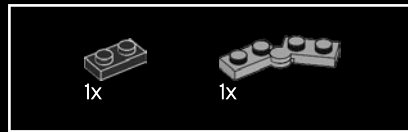

1x

1x

213

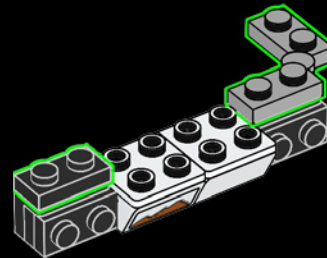



214

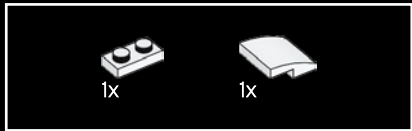
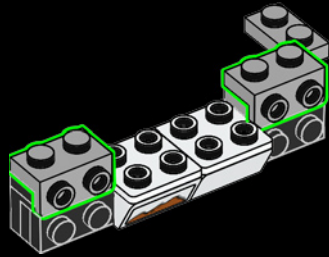

215

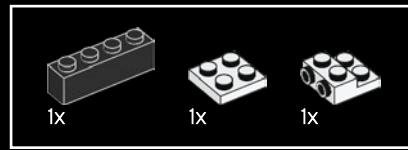
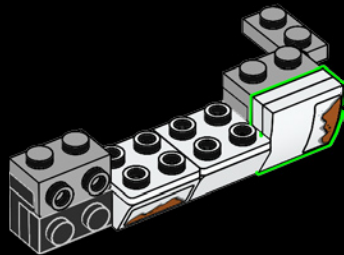
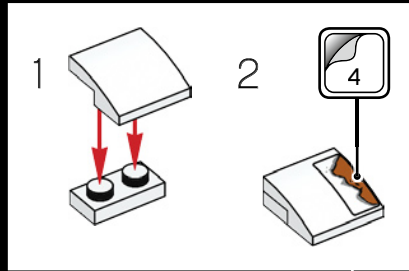

216

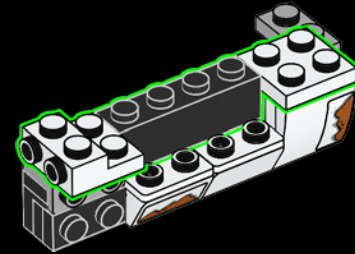

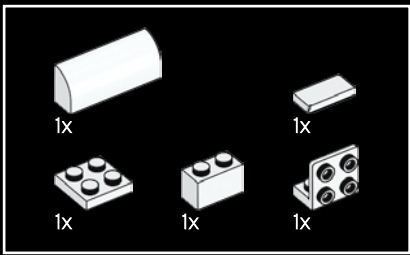

217

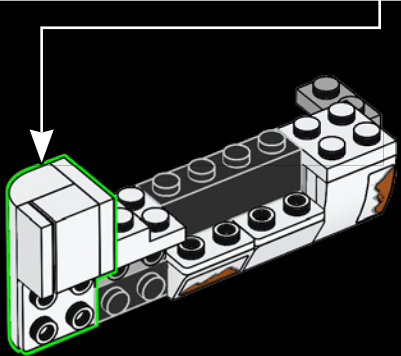
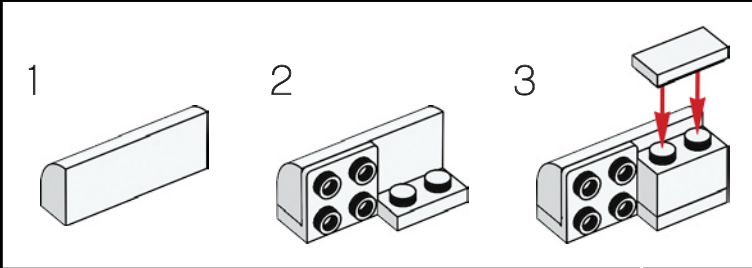

218

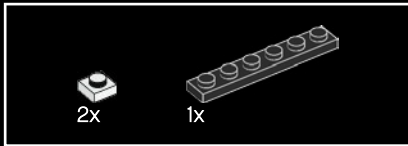
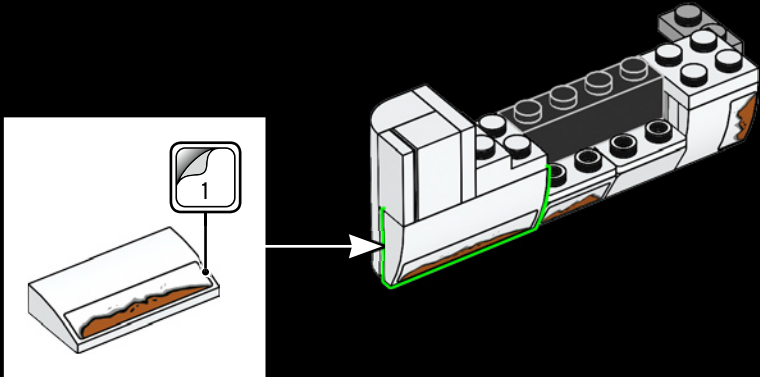

219

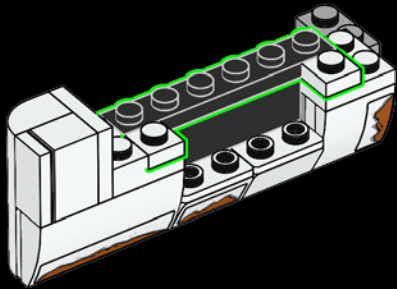

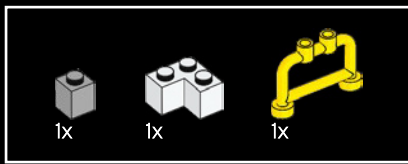

220

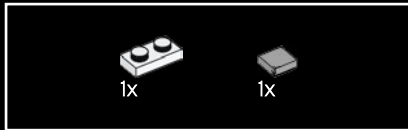
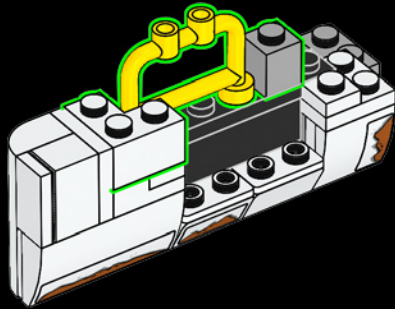

221

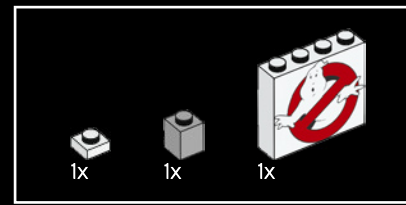
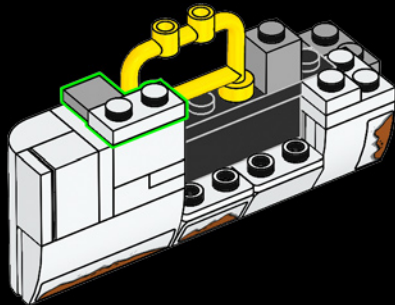

222

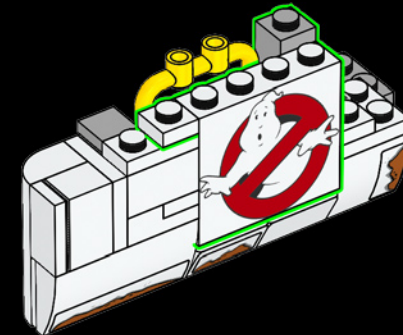

The No-Ghost logo has become a powerful marketing tool for the Ghostbusters business and features a ghost named Mooglie.

Le logo « fantômes interdits » est devenu un puissant outil de marketing pour l'entreprise des chasseurs de fantômes et met en vedette un fantôme nommé Mooglie.

El logotipo del fantasma atrapado en una señal de prohibido (llamado Mooglie) se ha convertido en una poderosa herramienta de mercadotecnia para la empresa de los cazafantasmas.

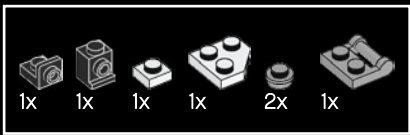

223

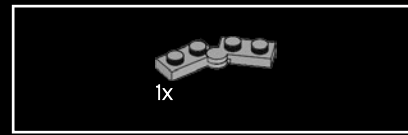
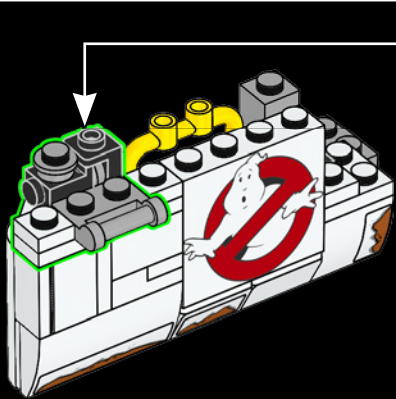
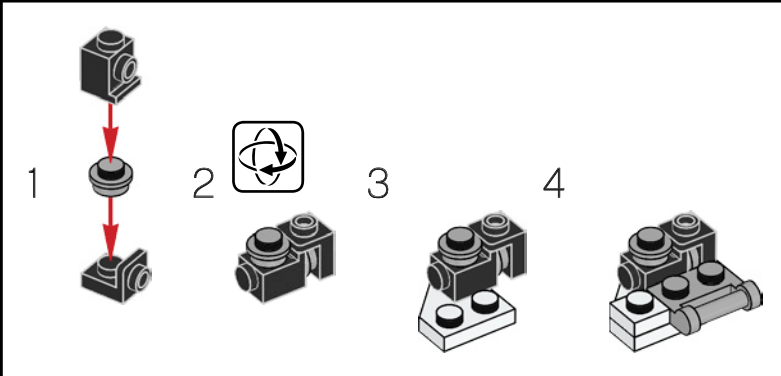

224

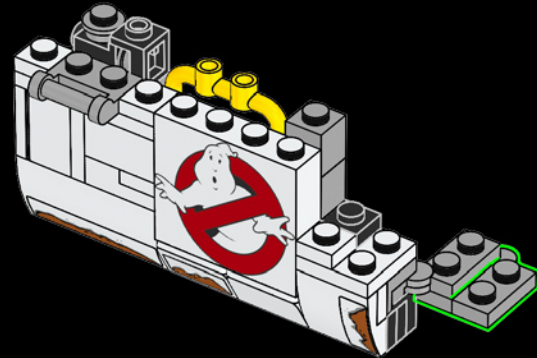

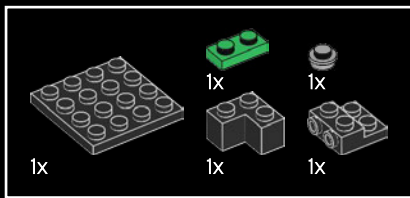

225

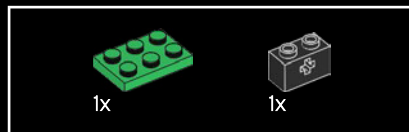
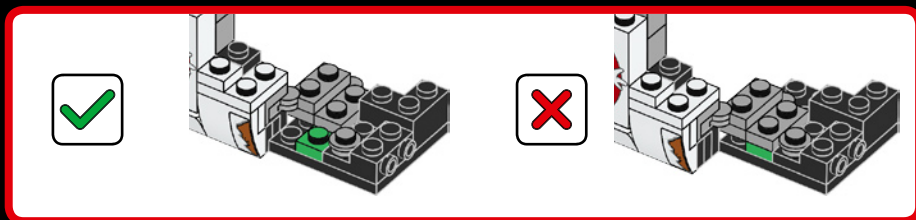
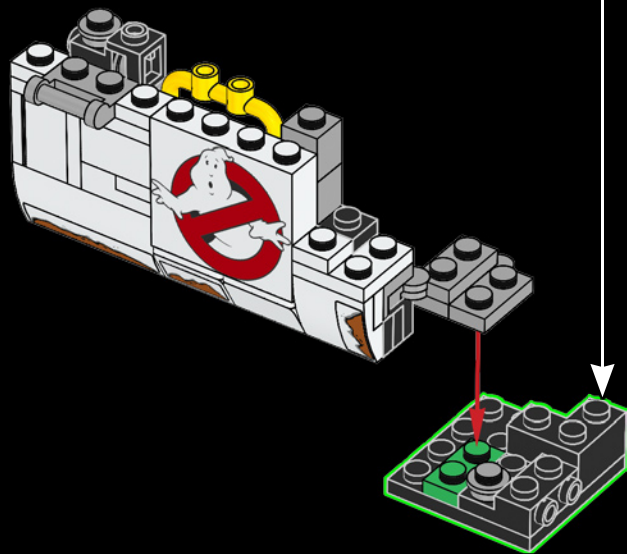
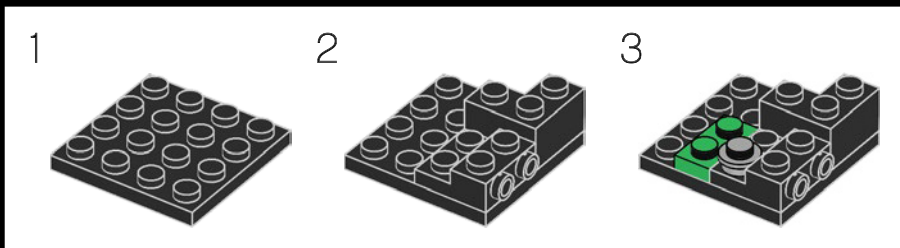

226

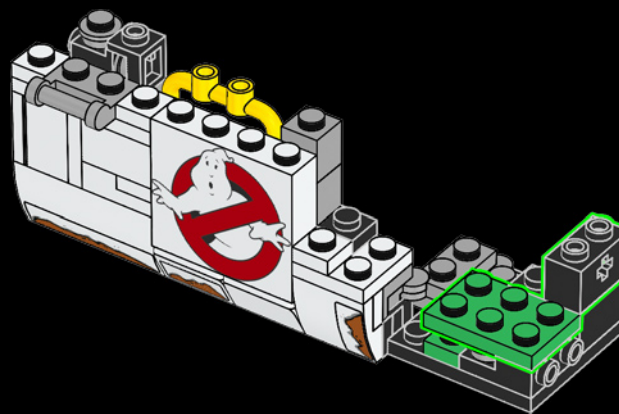

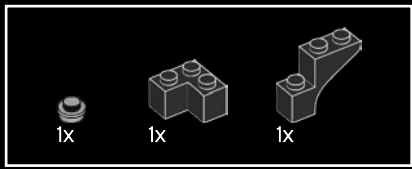

227

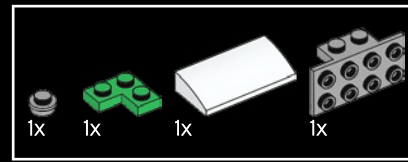
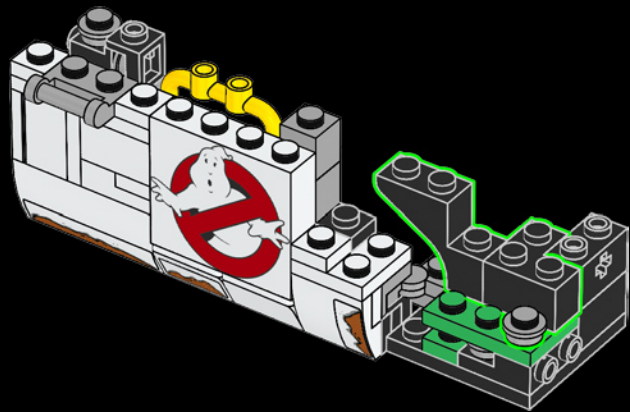

228

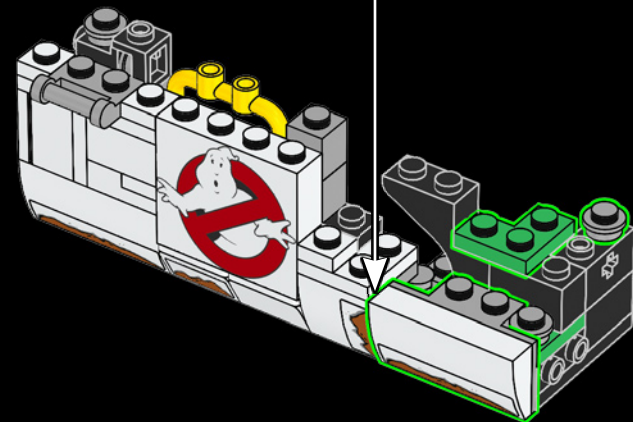
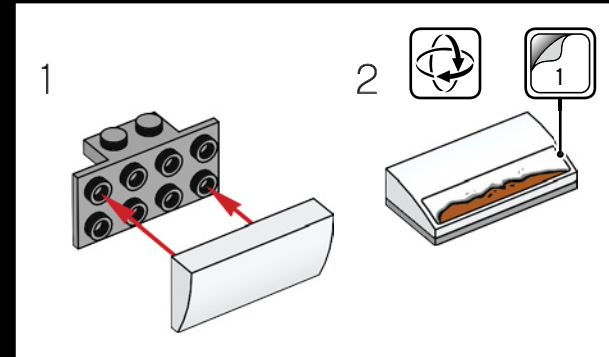



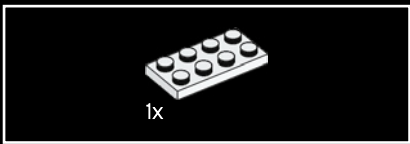

229

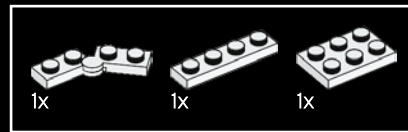
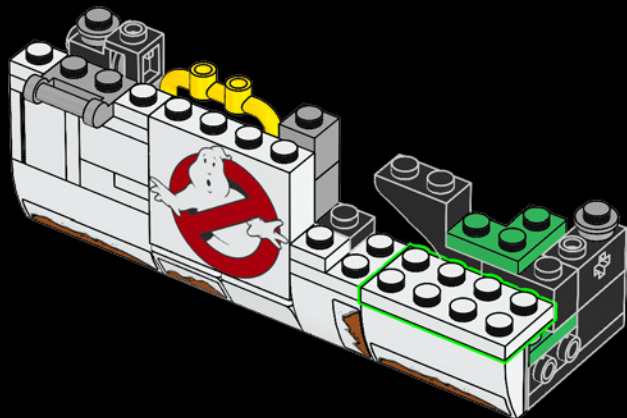

230

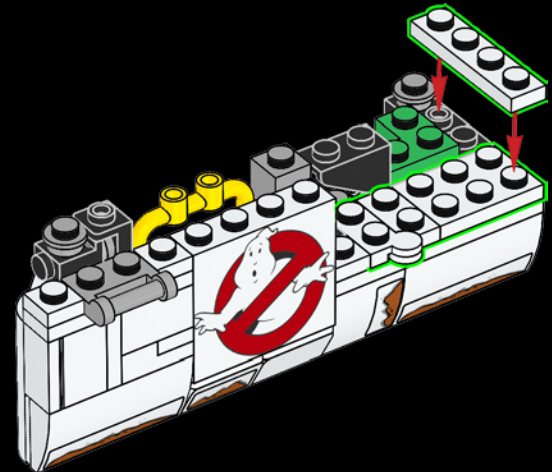

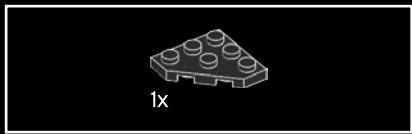

231

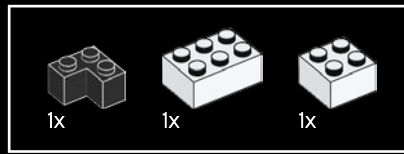
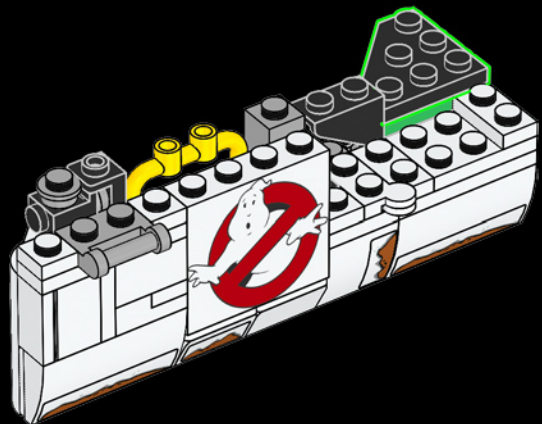

232

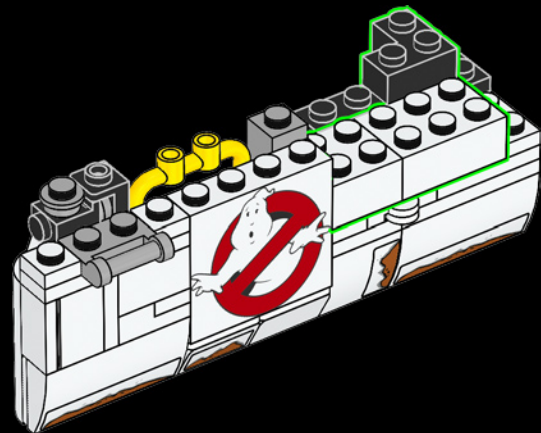

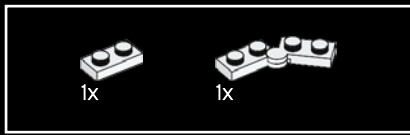

233

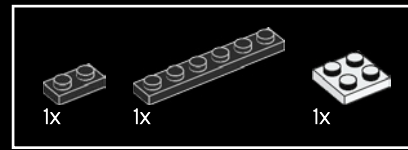
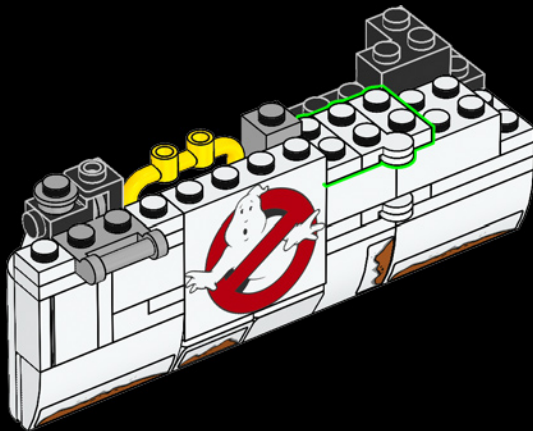

234

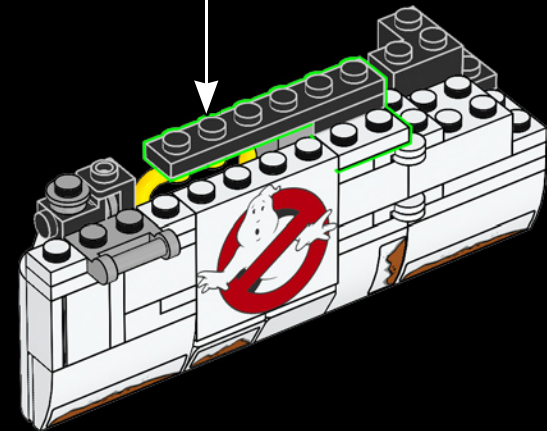
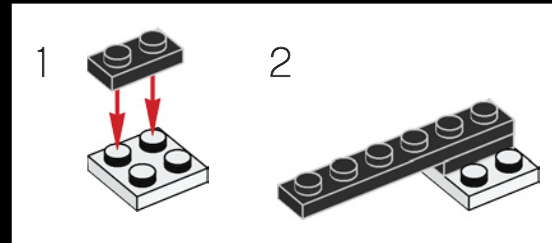

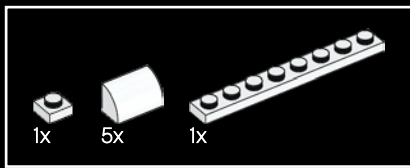

235

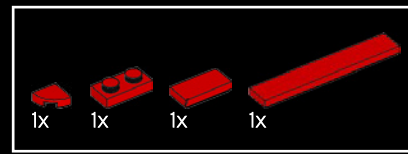
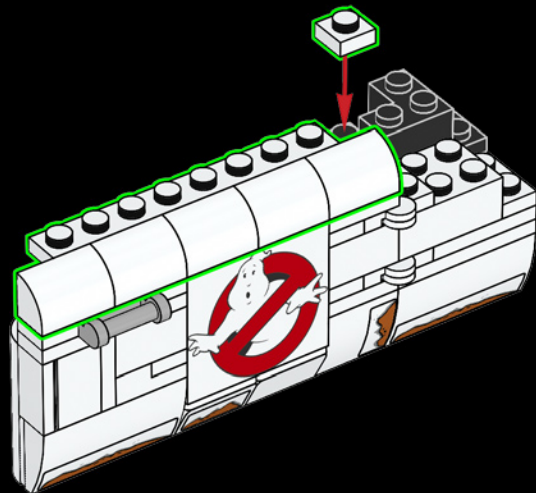

236

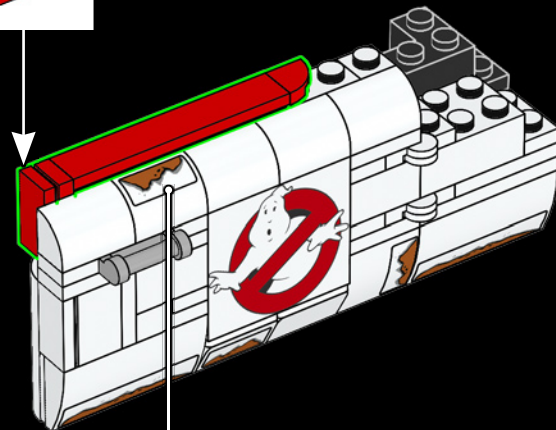
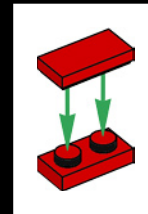

237

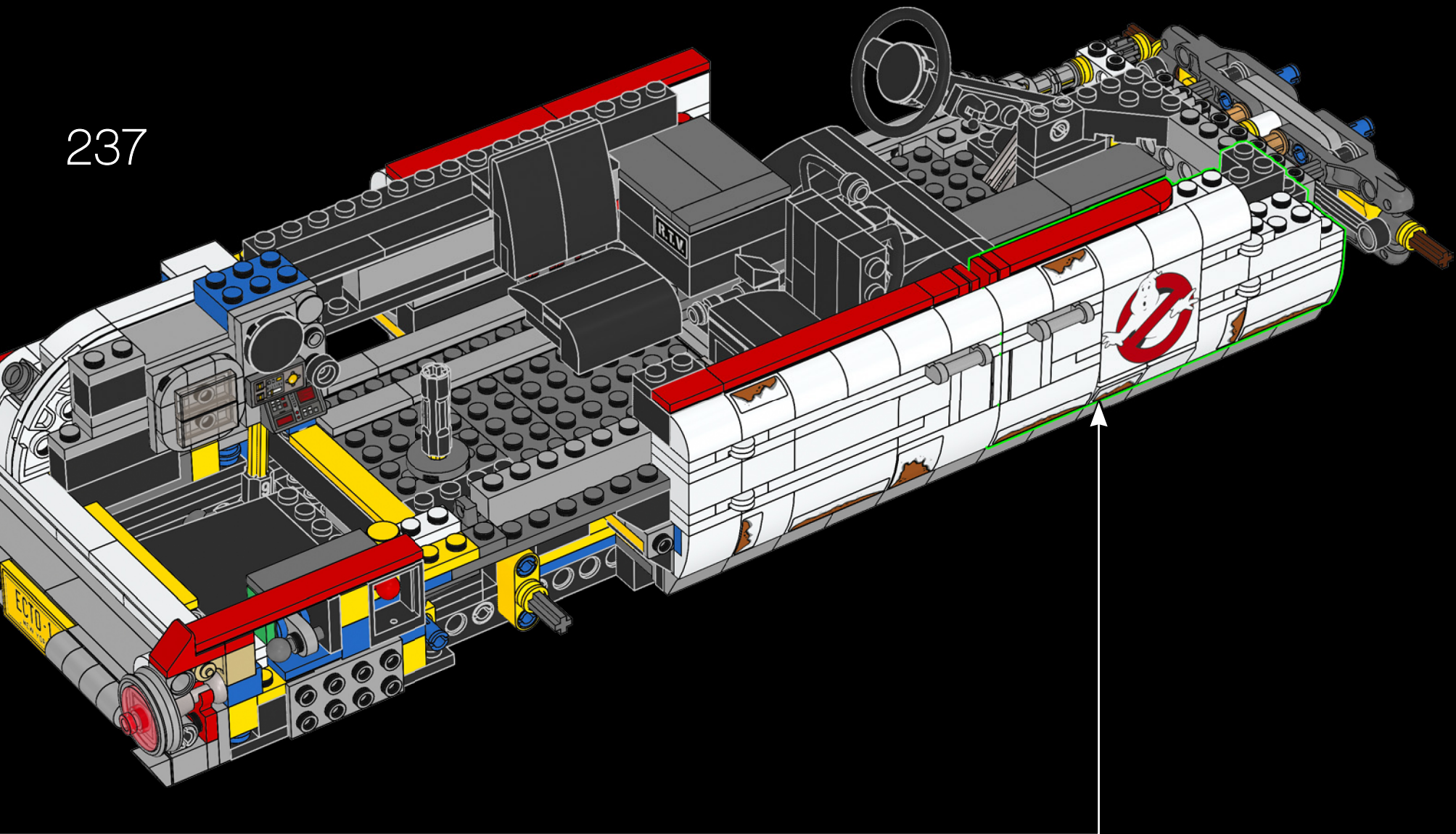

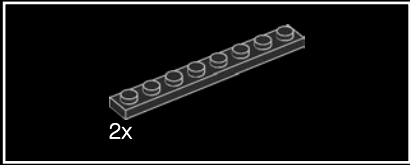
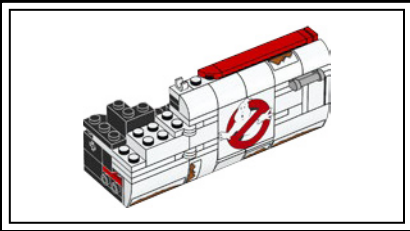

238

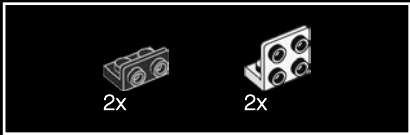
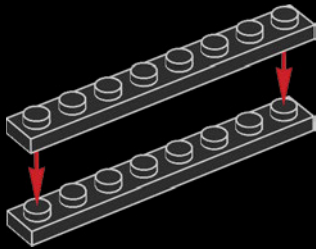

239

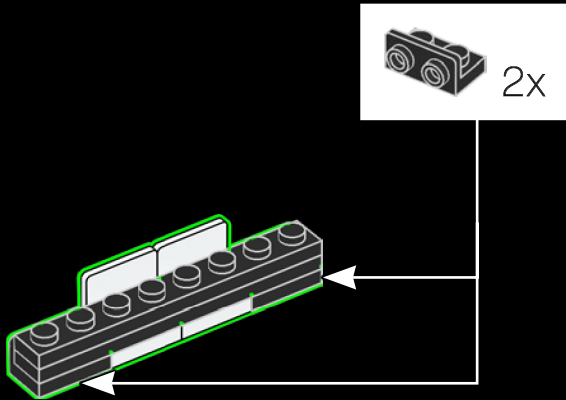

240

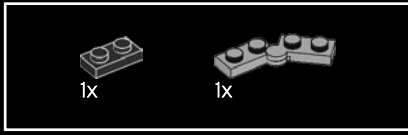
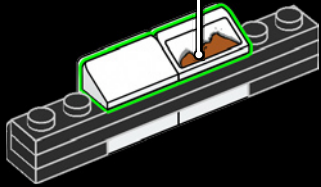

241

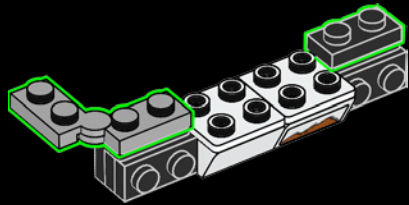



242

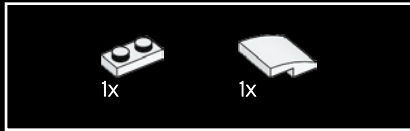
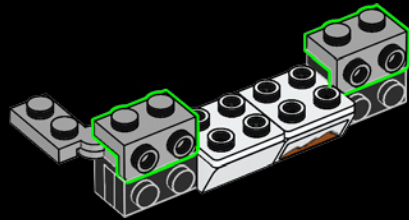

243

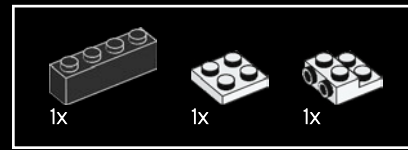
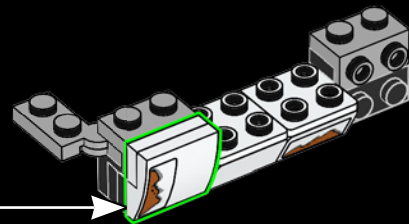
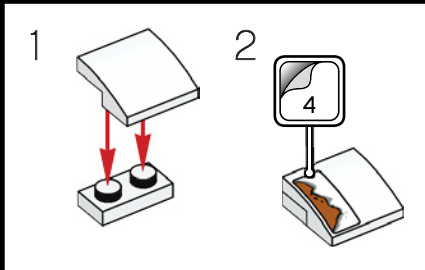

244

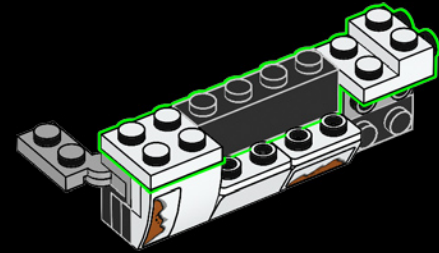

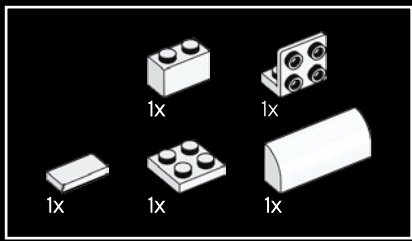

245

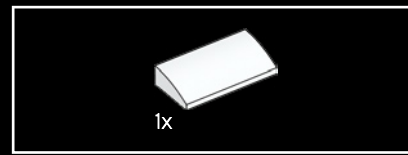
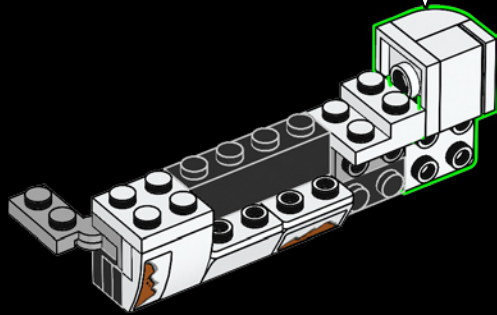
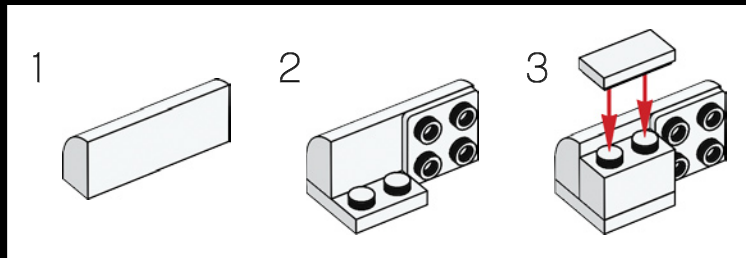

246

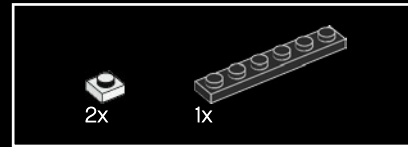
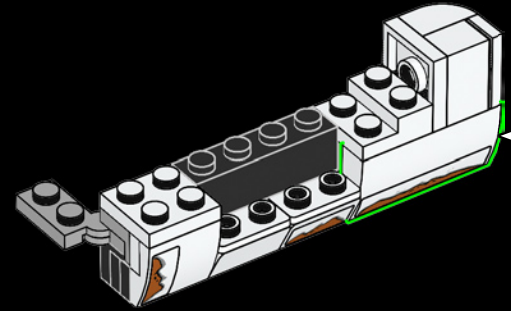
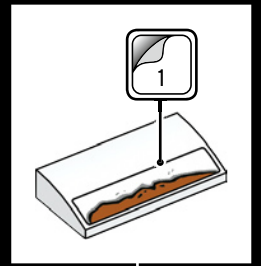

247

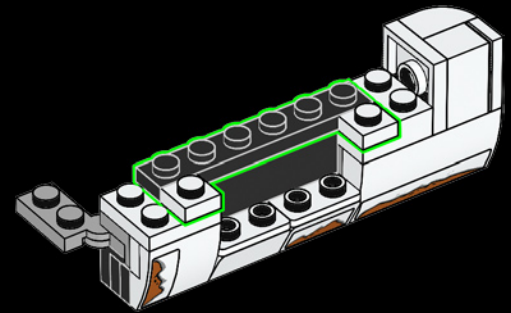



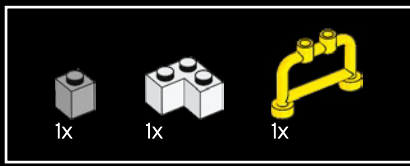

248

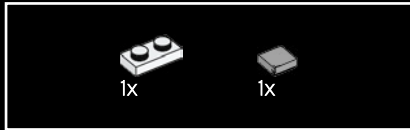
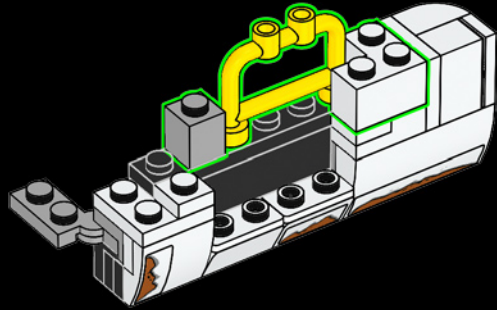

249

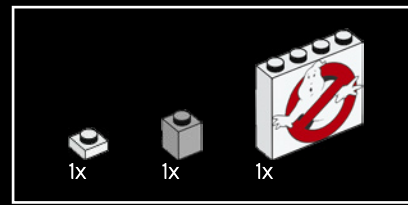
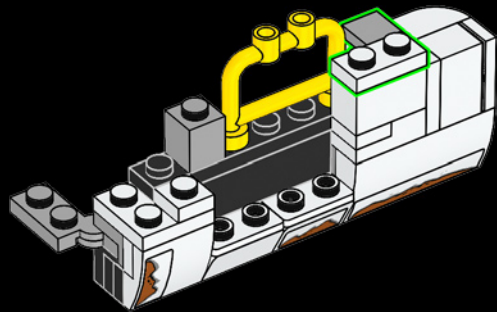

250

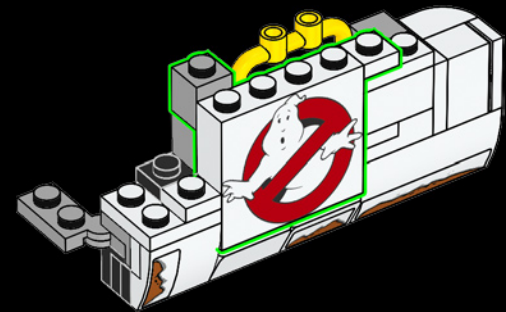

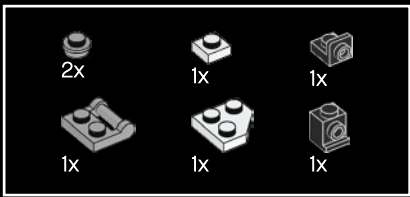

251

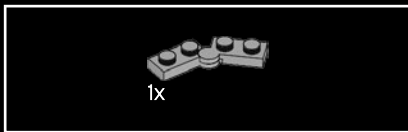
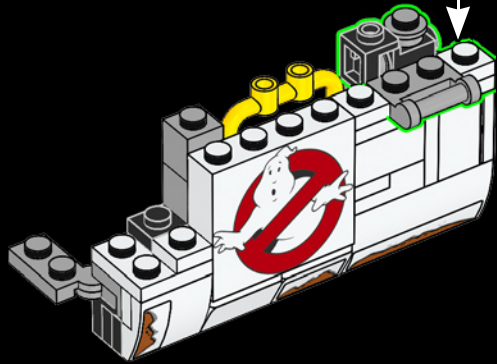
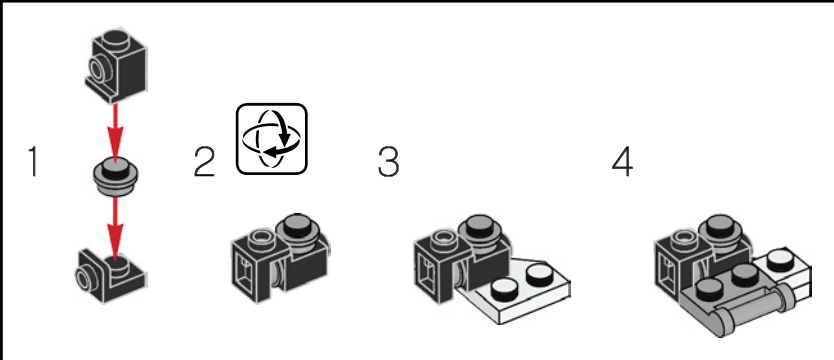

252

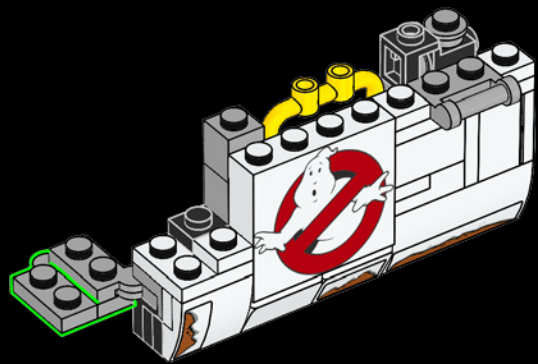

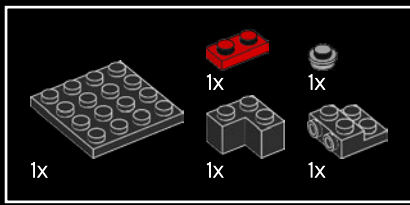

253

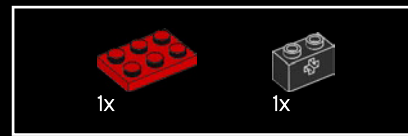
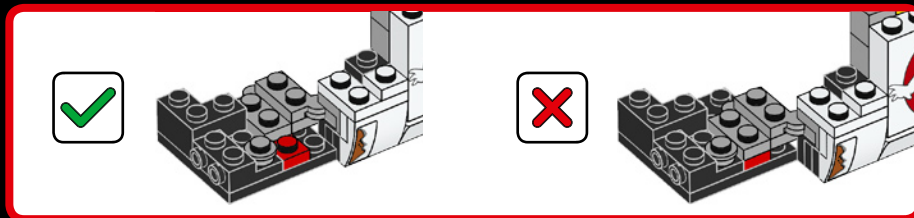
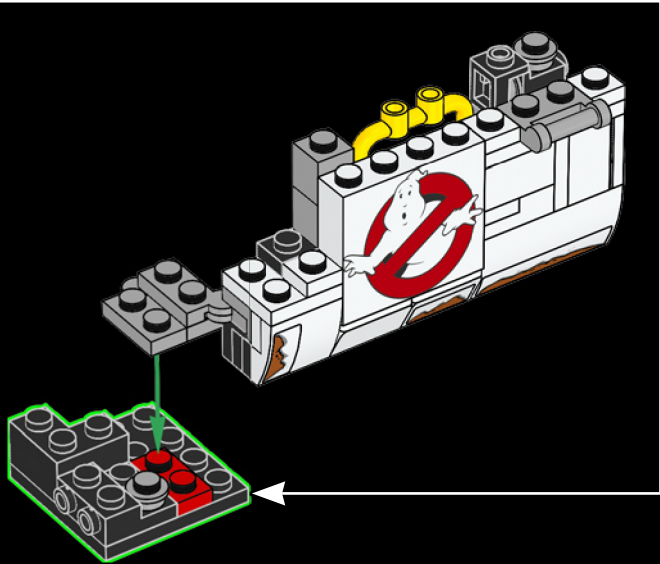
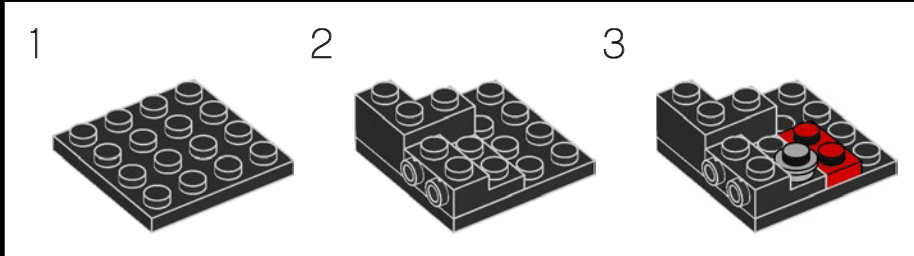

254

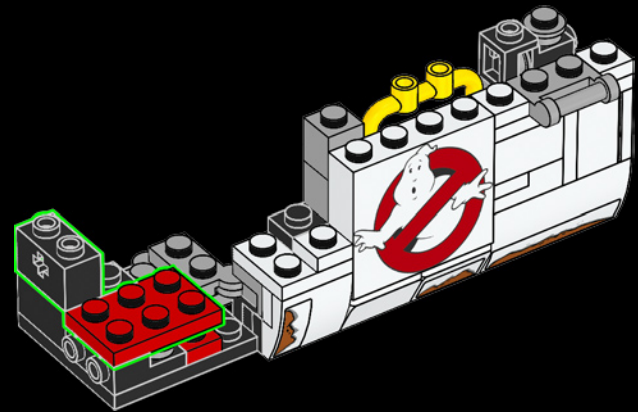

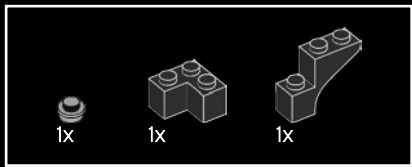

255

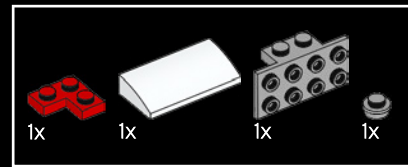
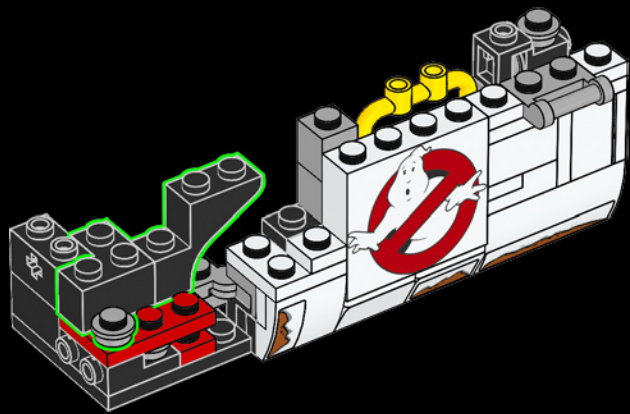

256

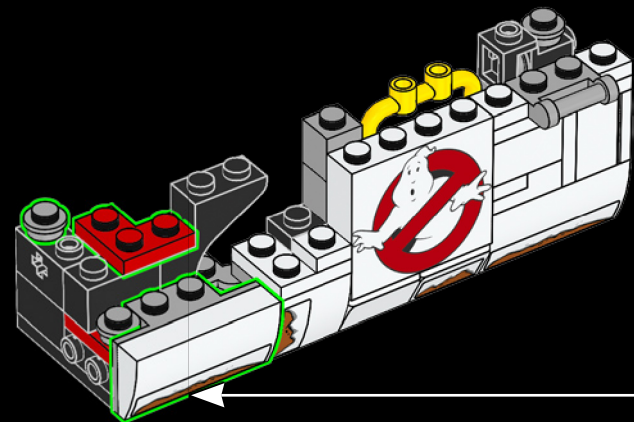
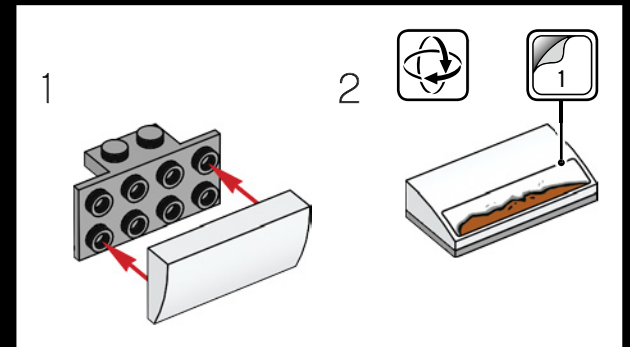

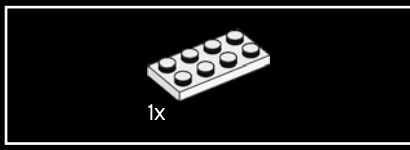

257

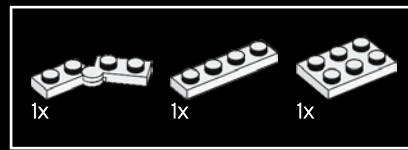
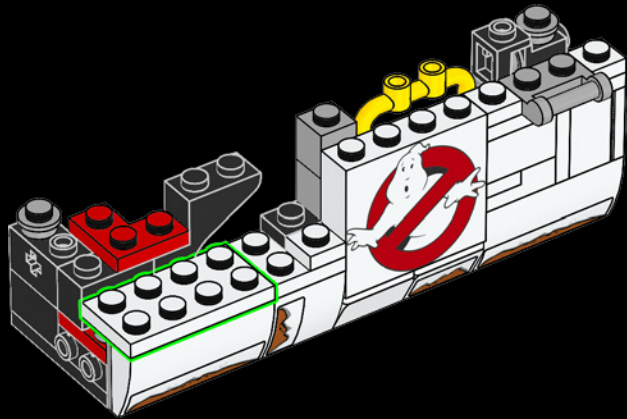

258

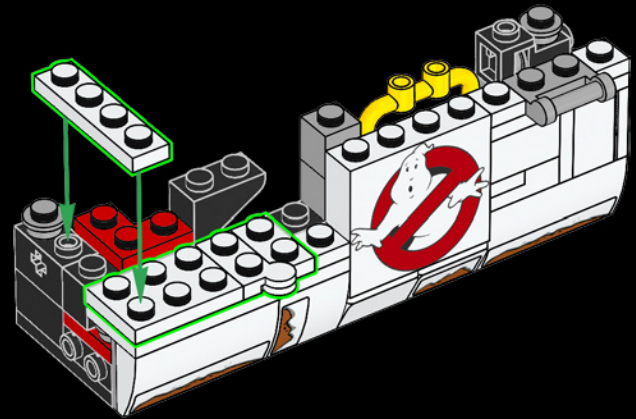

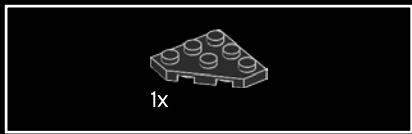

259

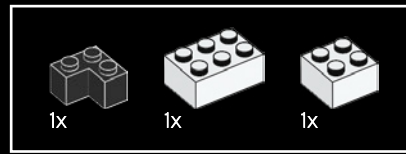
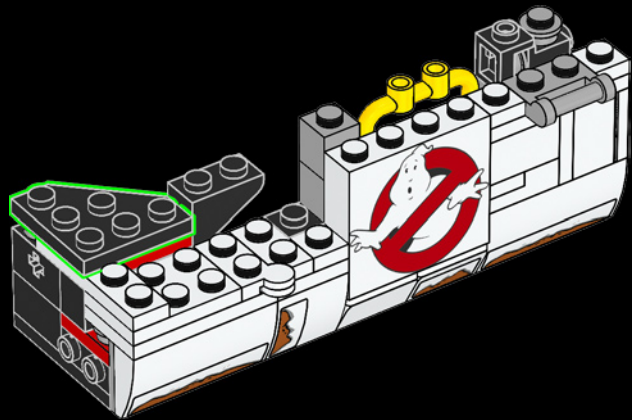

260

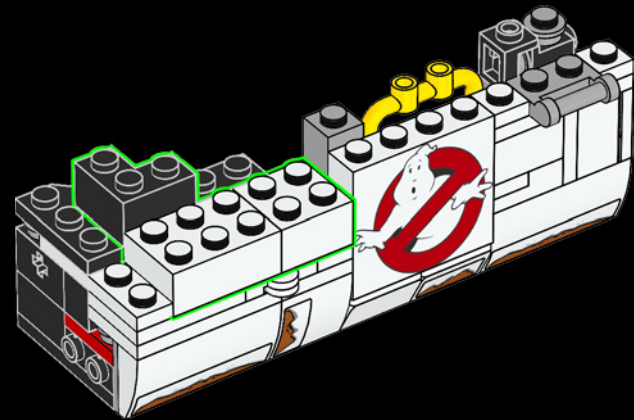

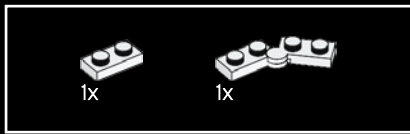

261

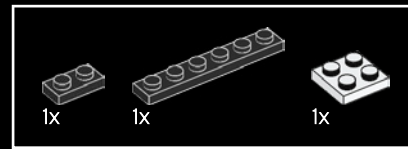
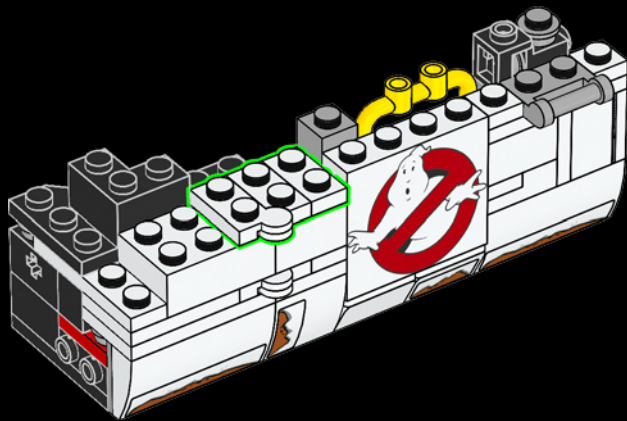

262

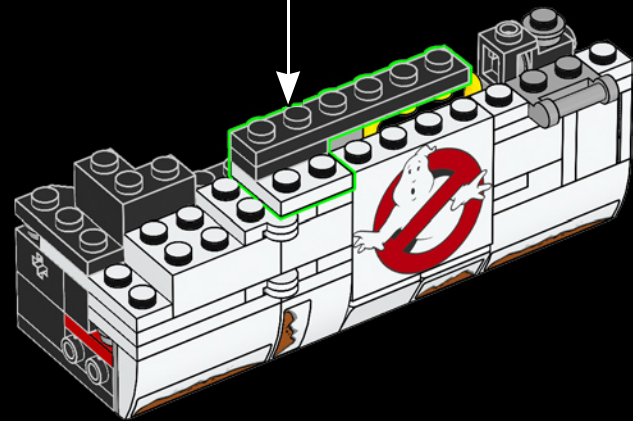
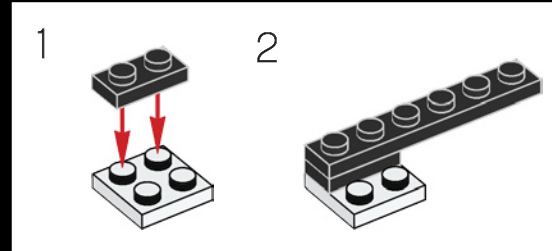

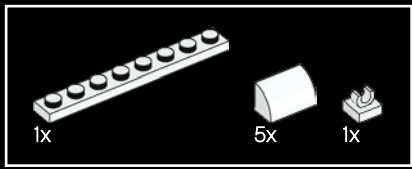

263

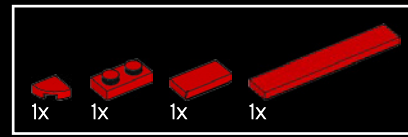
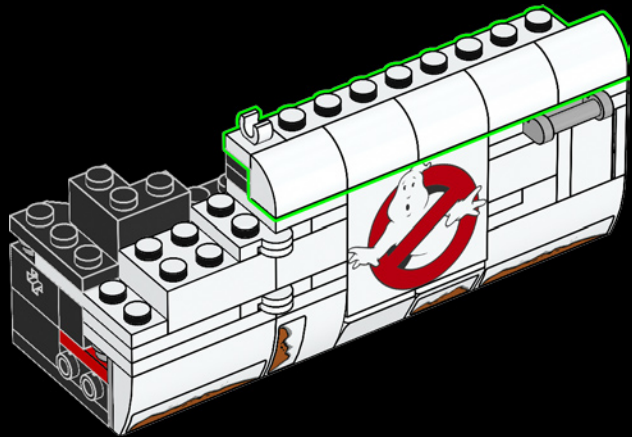

264

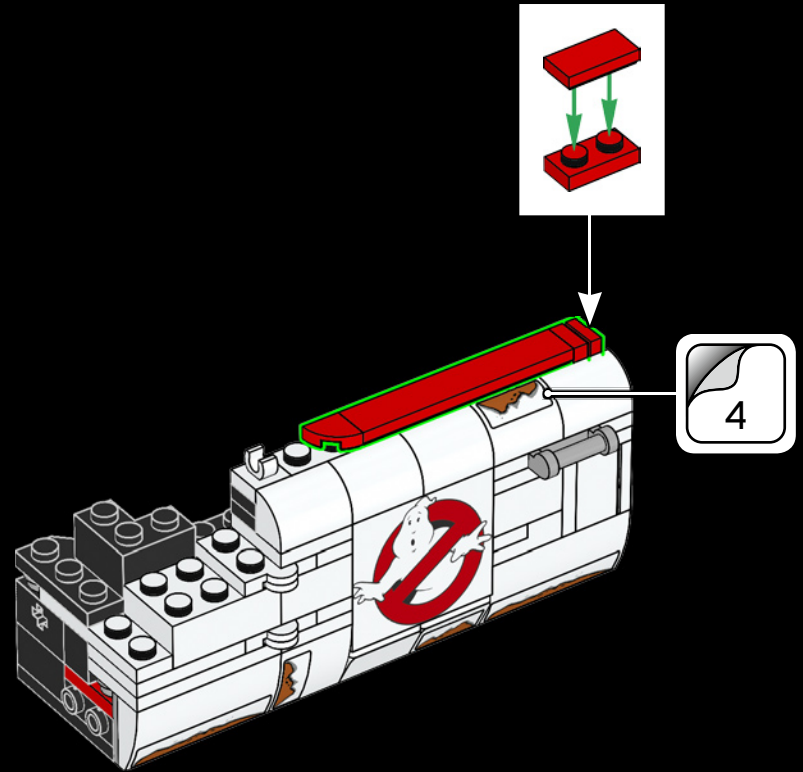



265

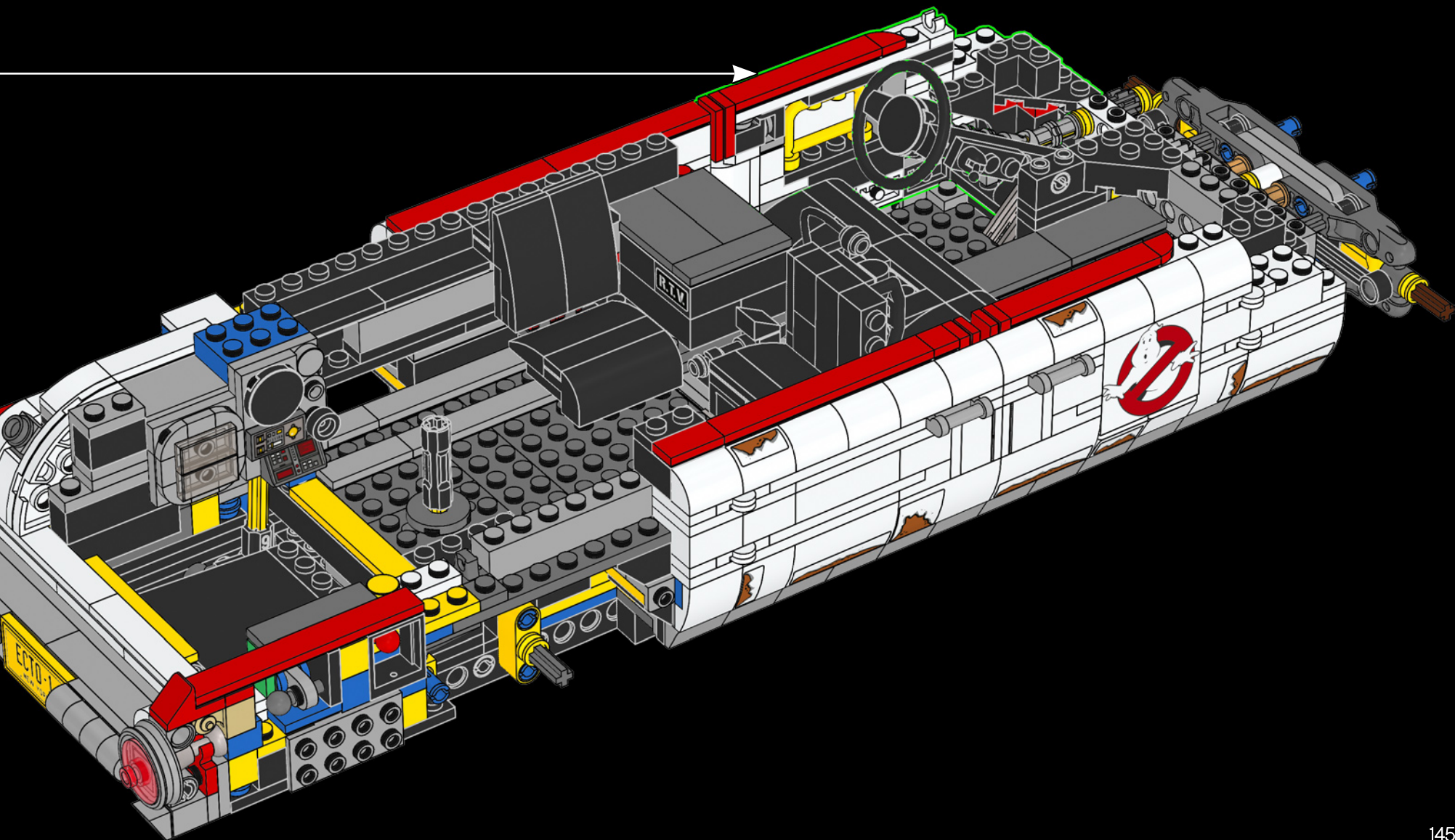

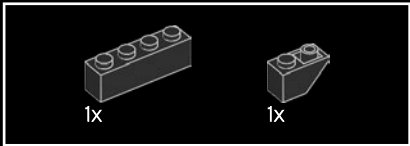
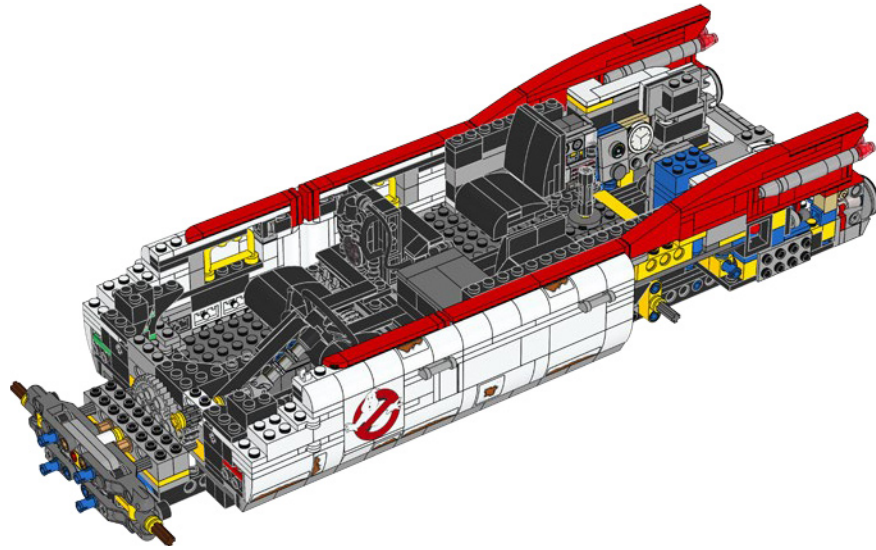
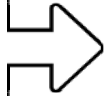

266

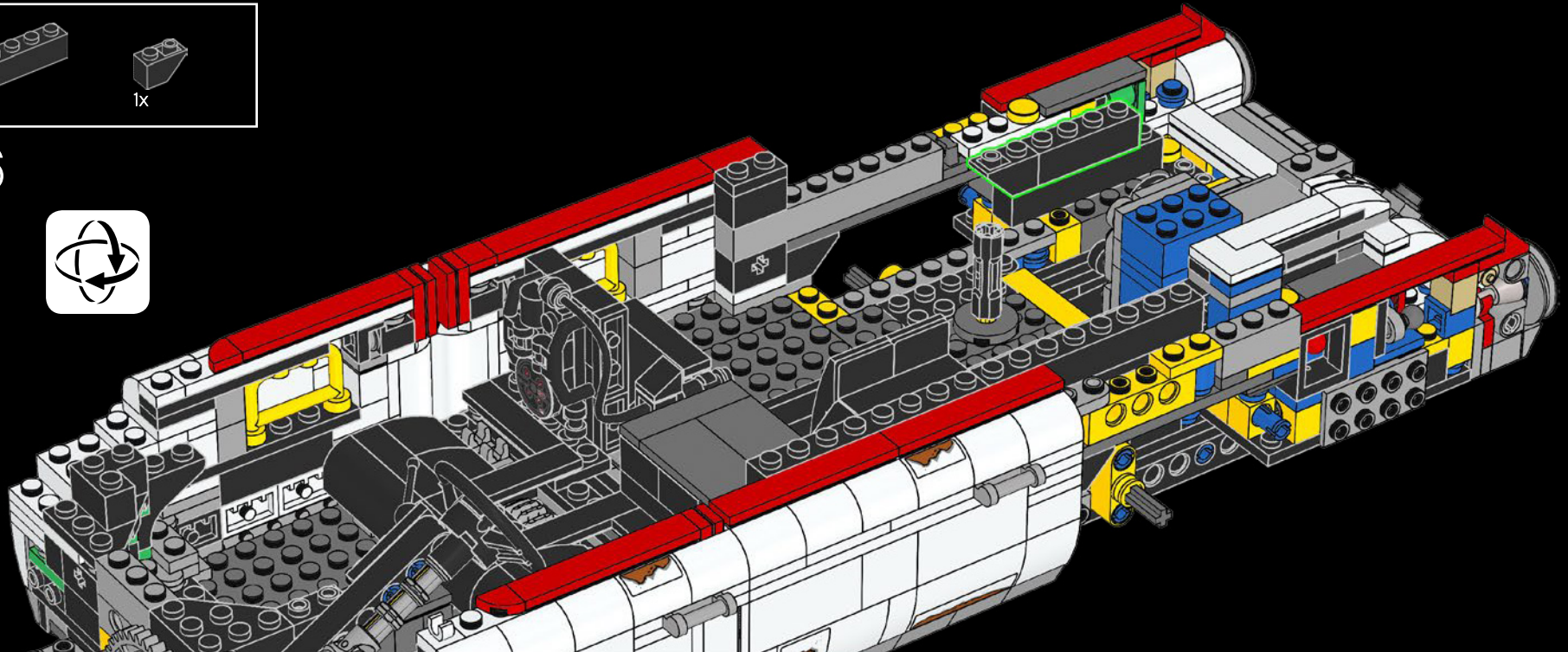

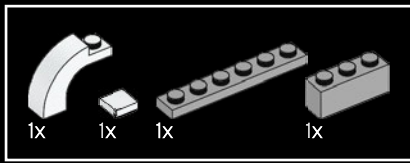

267

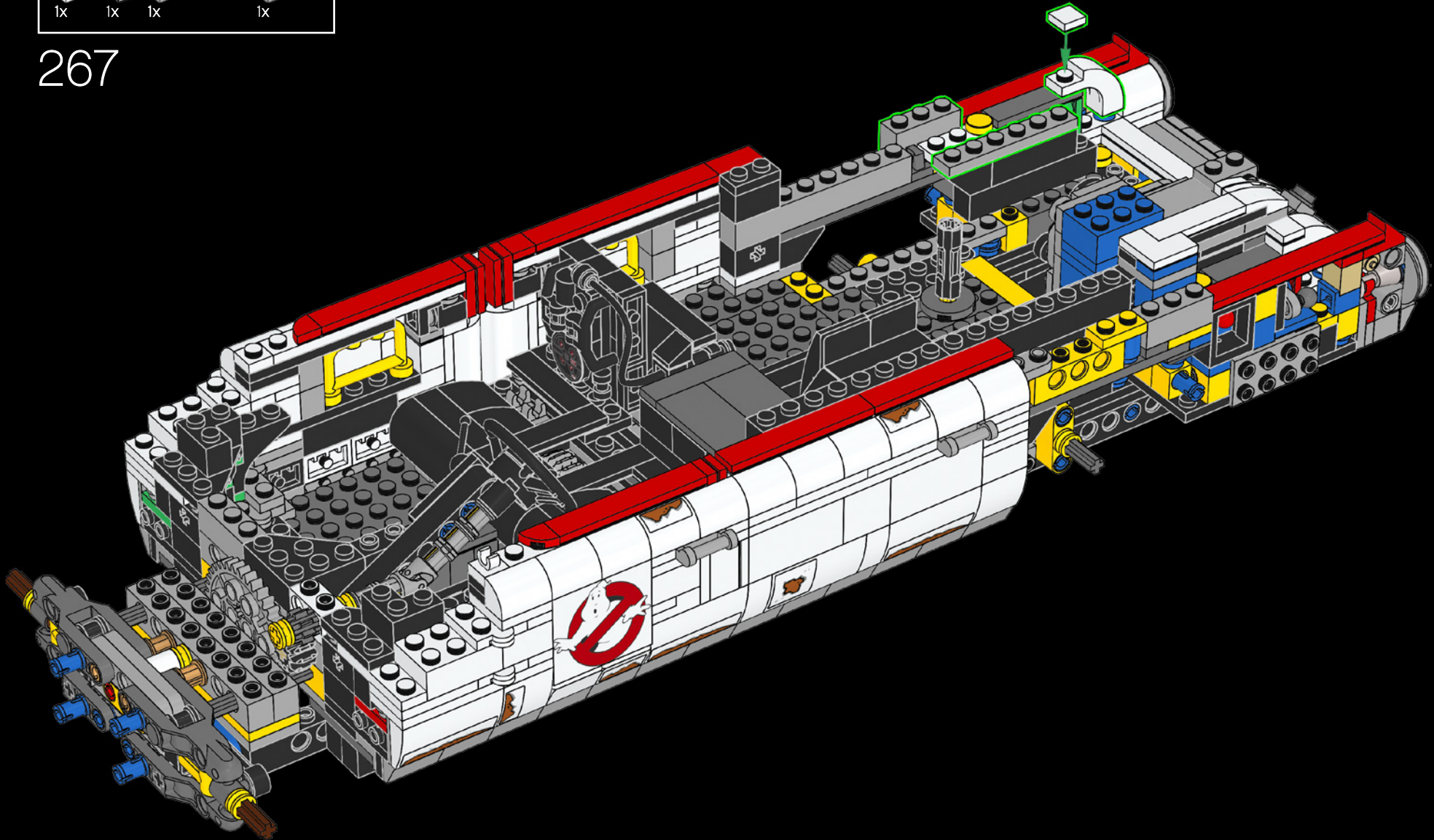

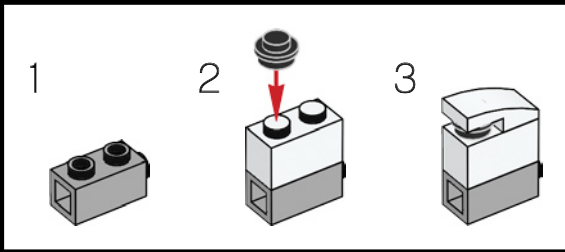
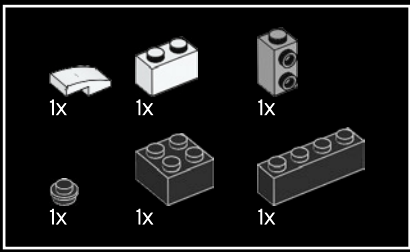

268

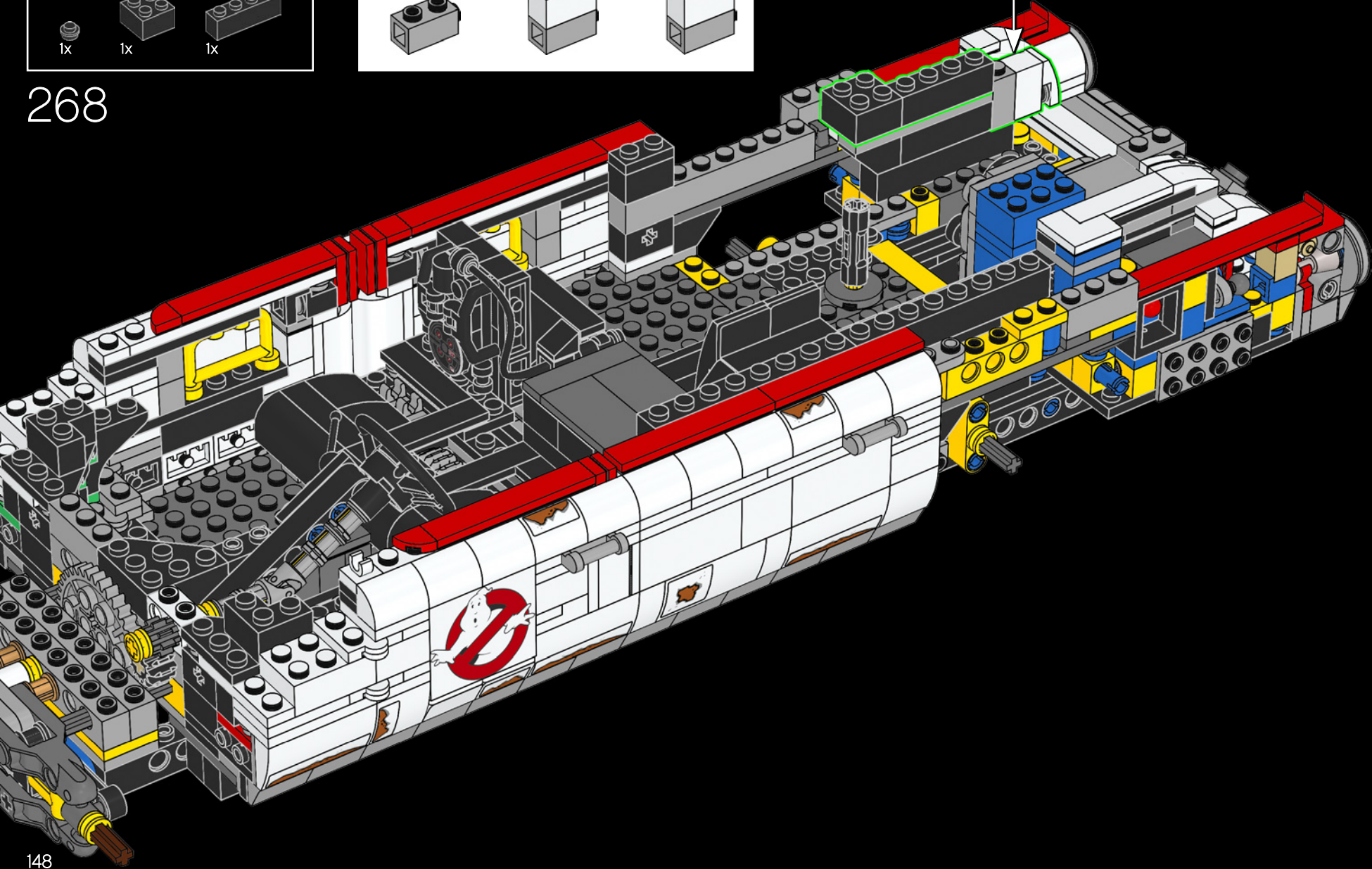

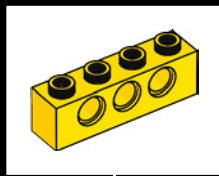
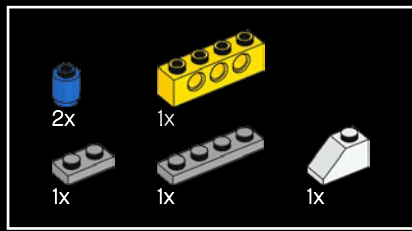

269

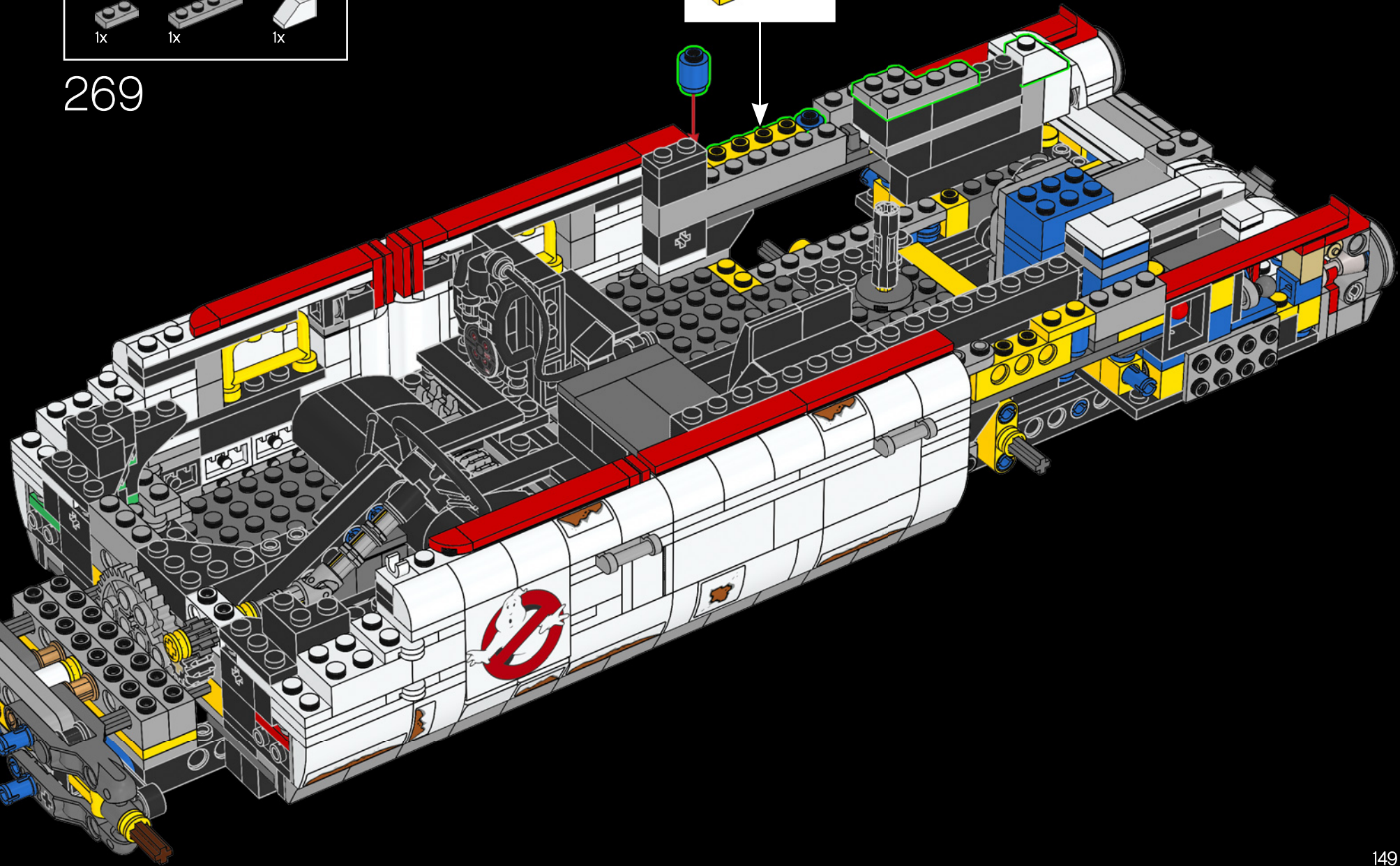

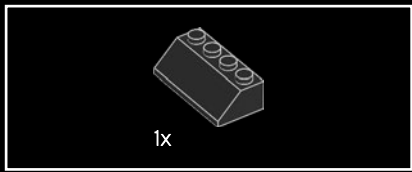

270

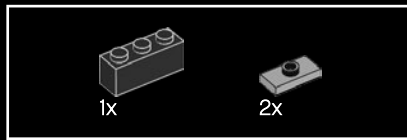
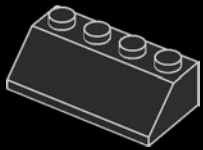

271

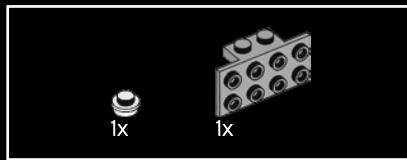
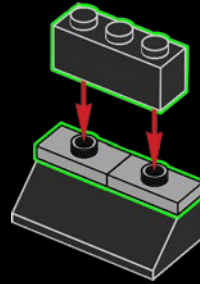

272

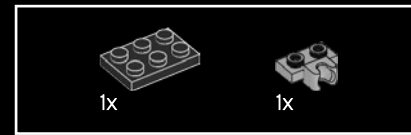
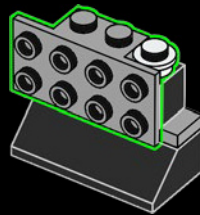

273

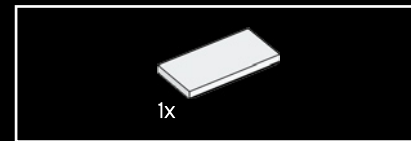
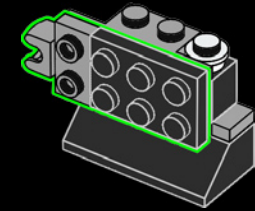

274

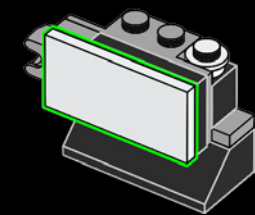

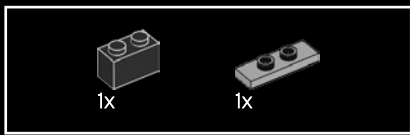

275

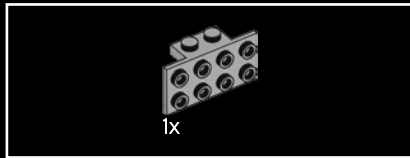
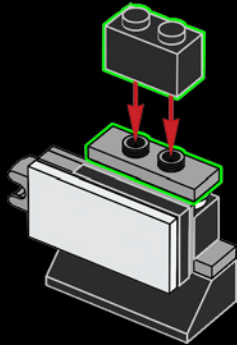

276

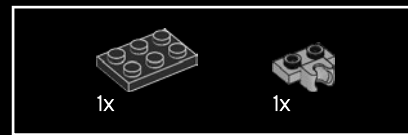
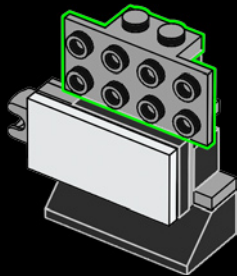

277

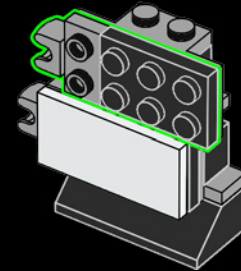

278

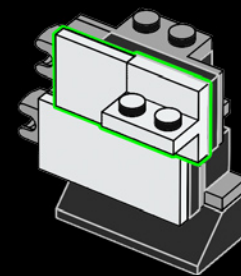

279

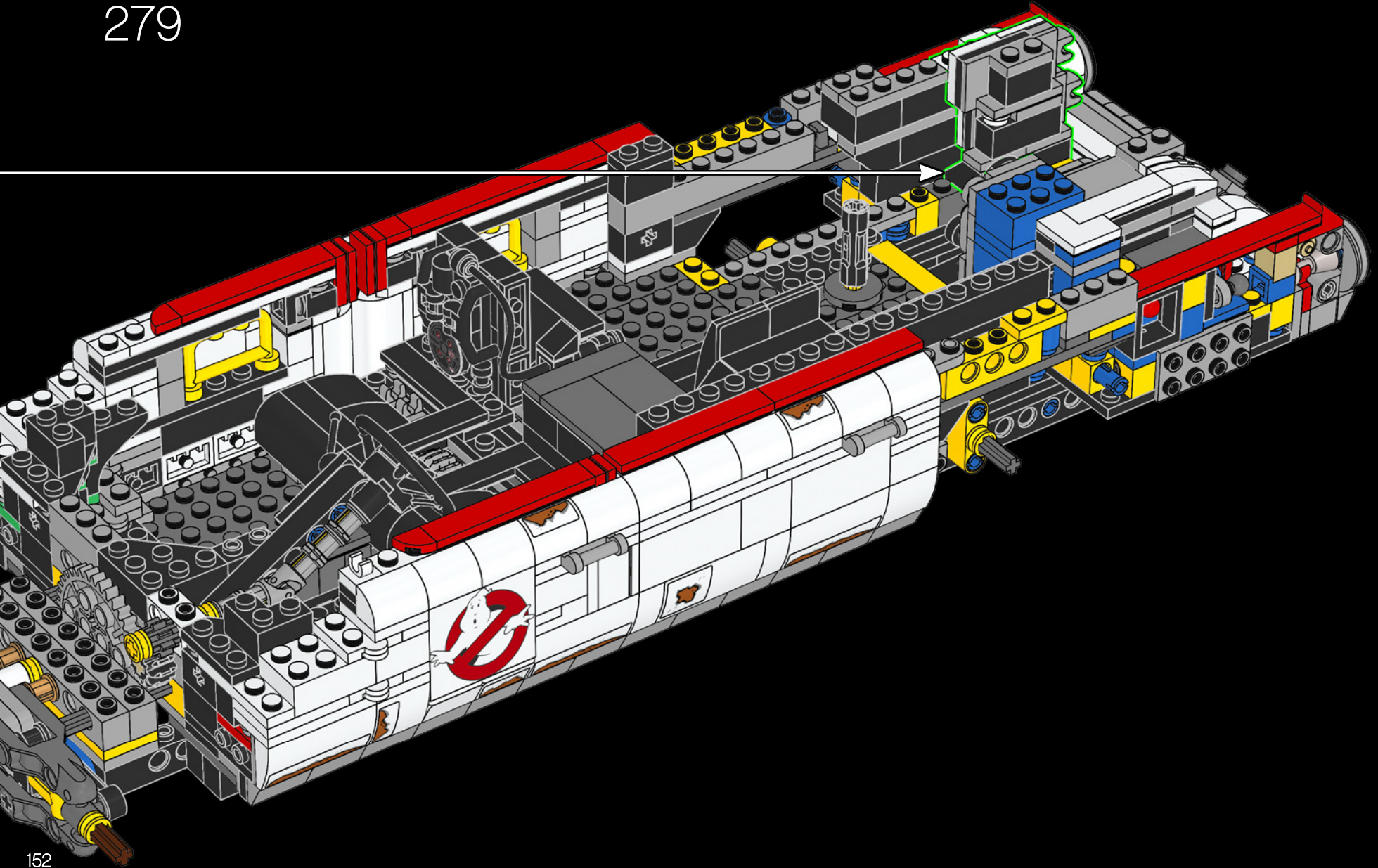



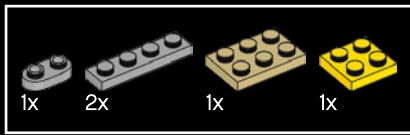

280

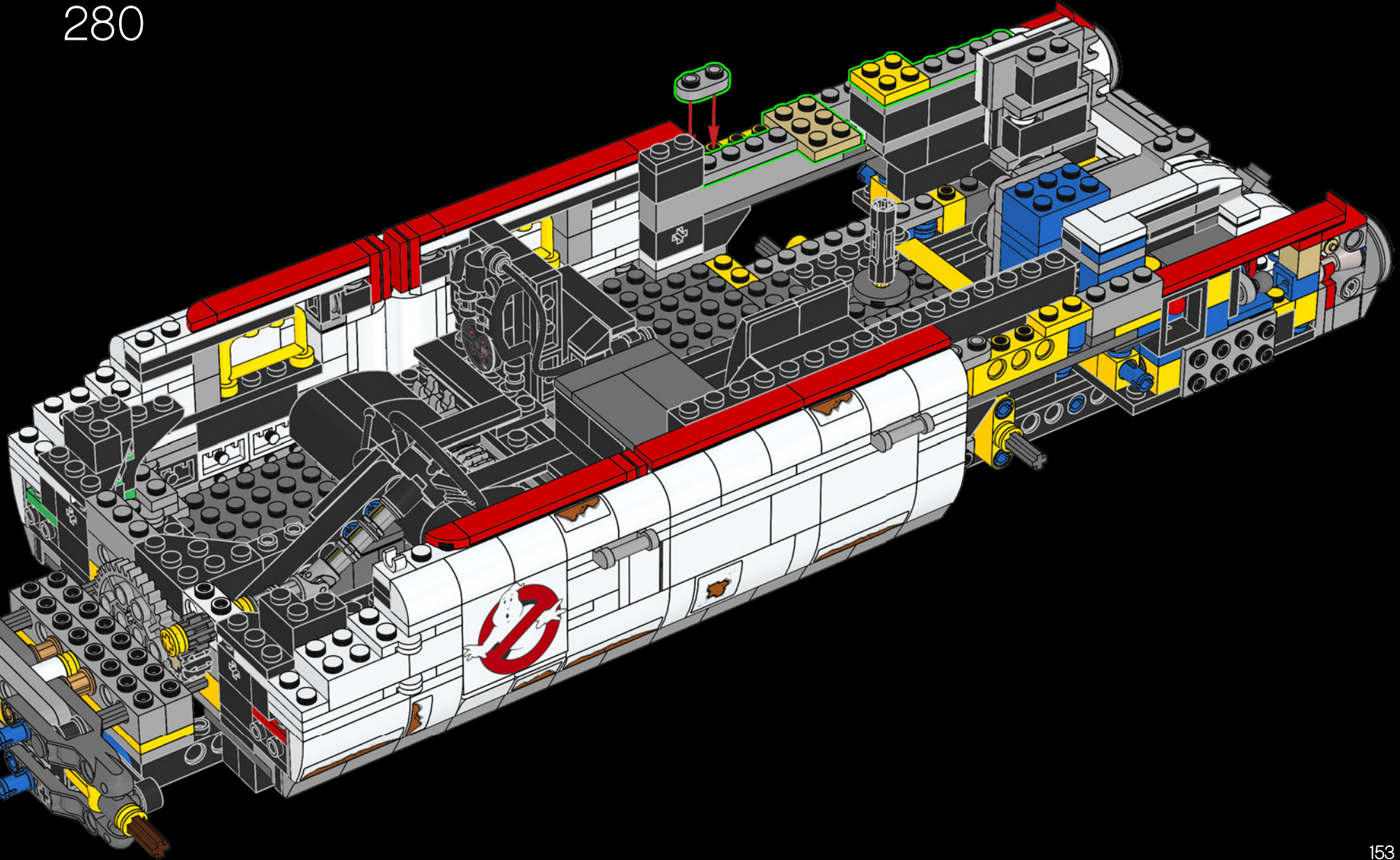

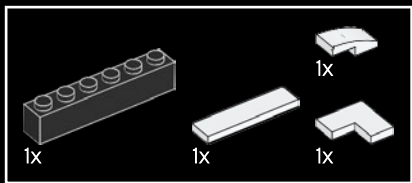

281

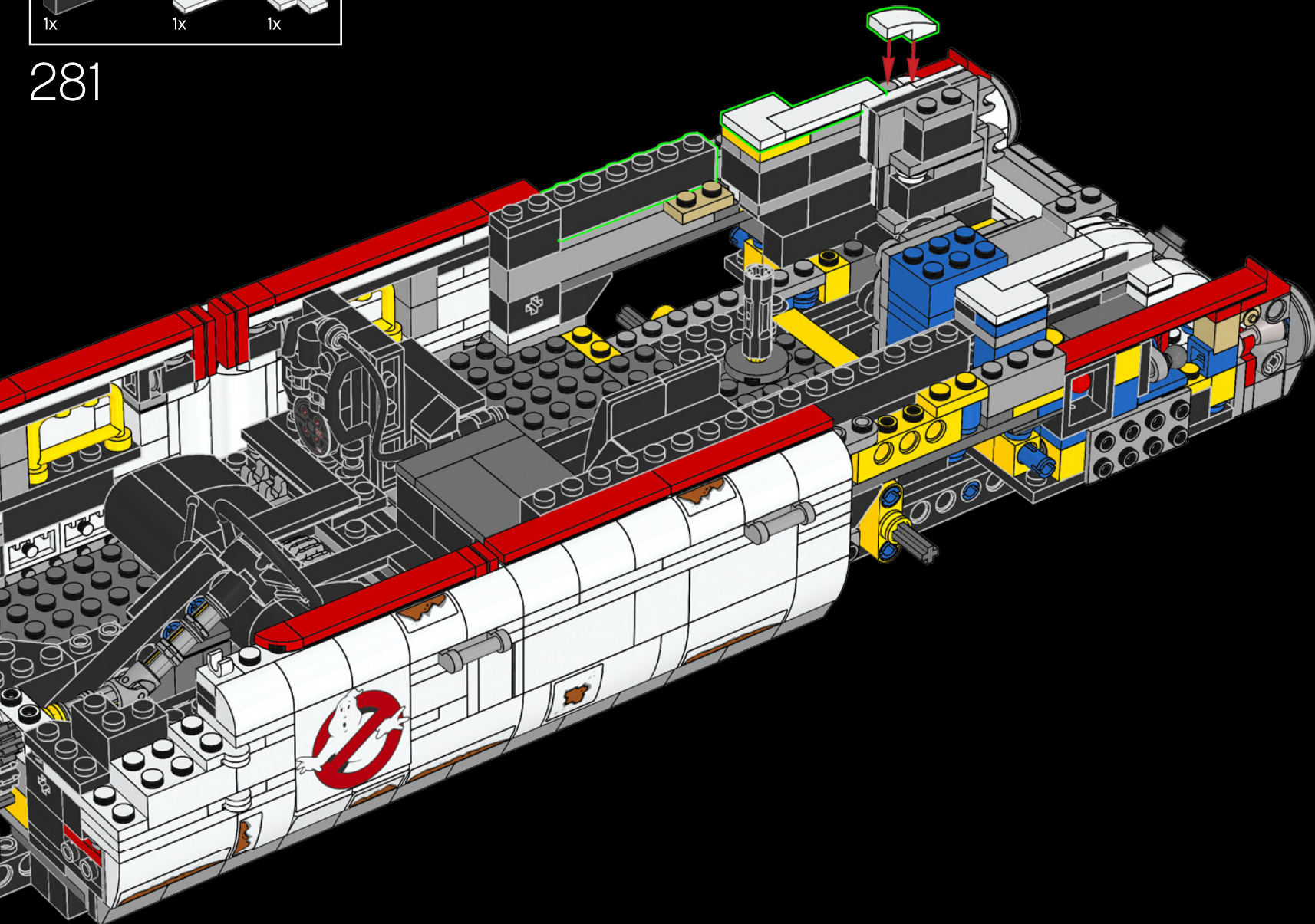

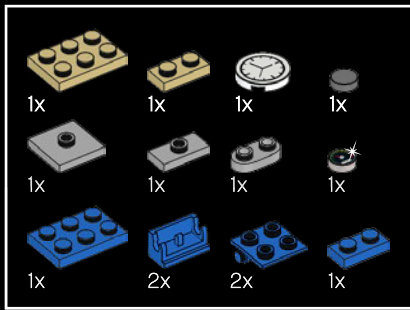

282

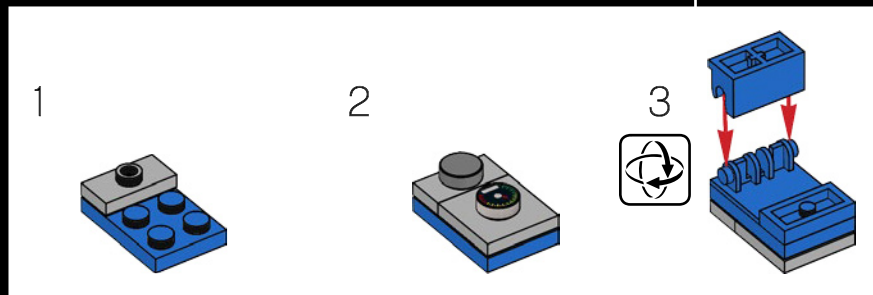
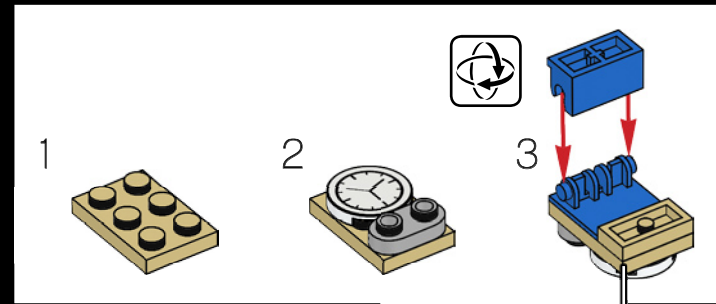
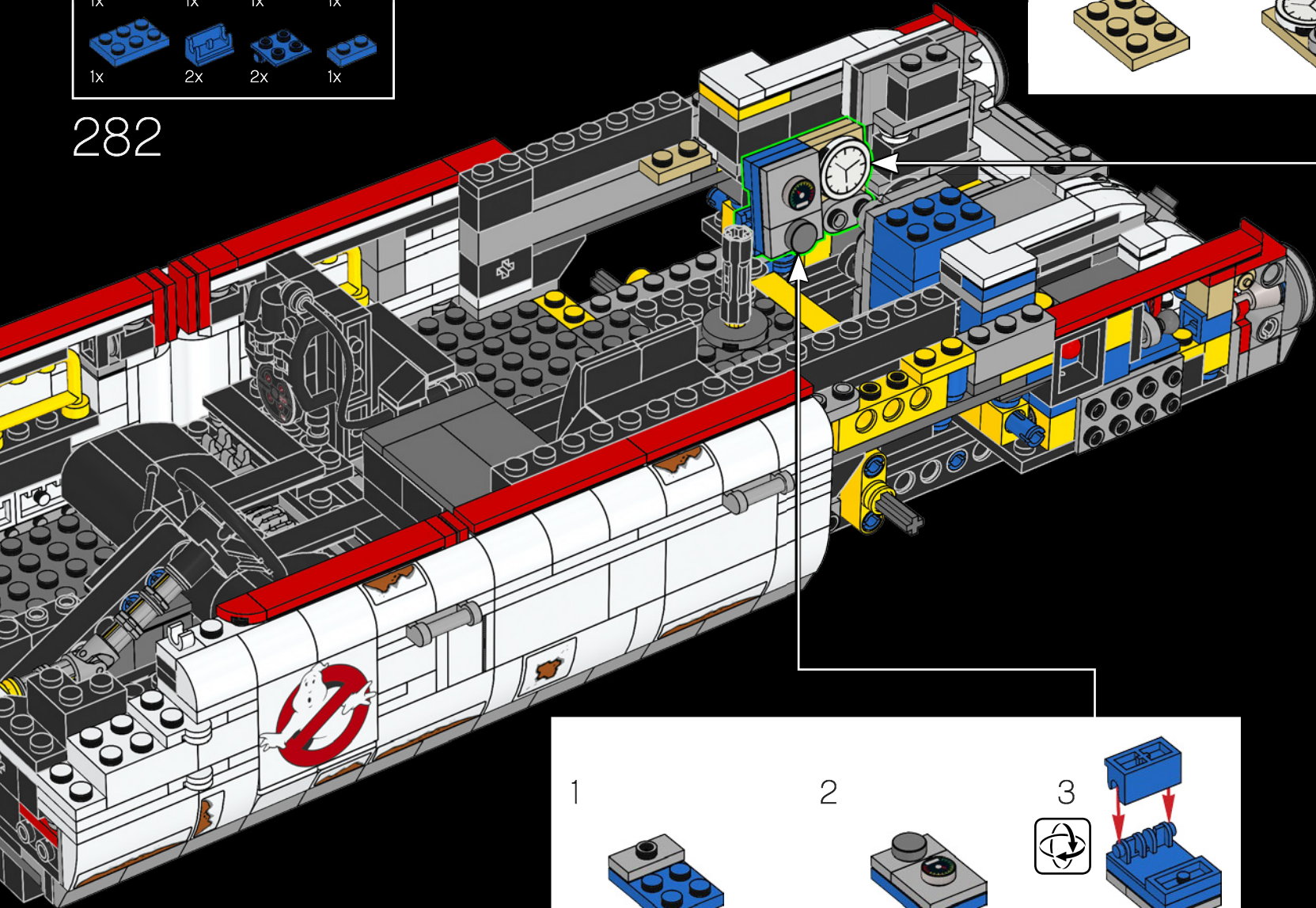

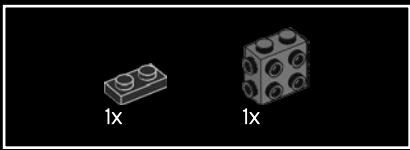

283

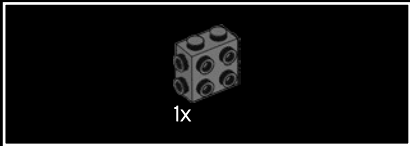
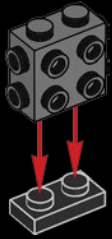

284

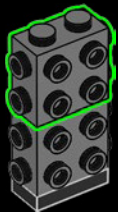

285



286

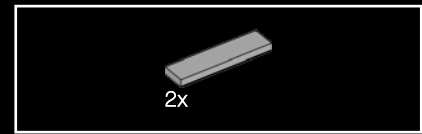

287

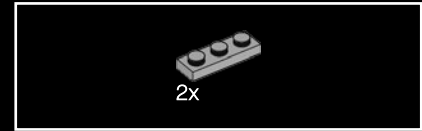

288

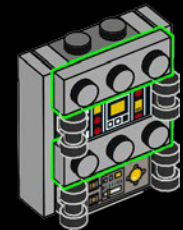

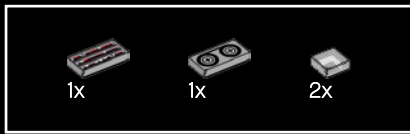

289



290

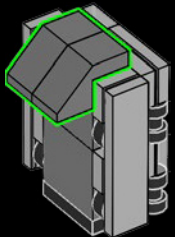

291

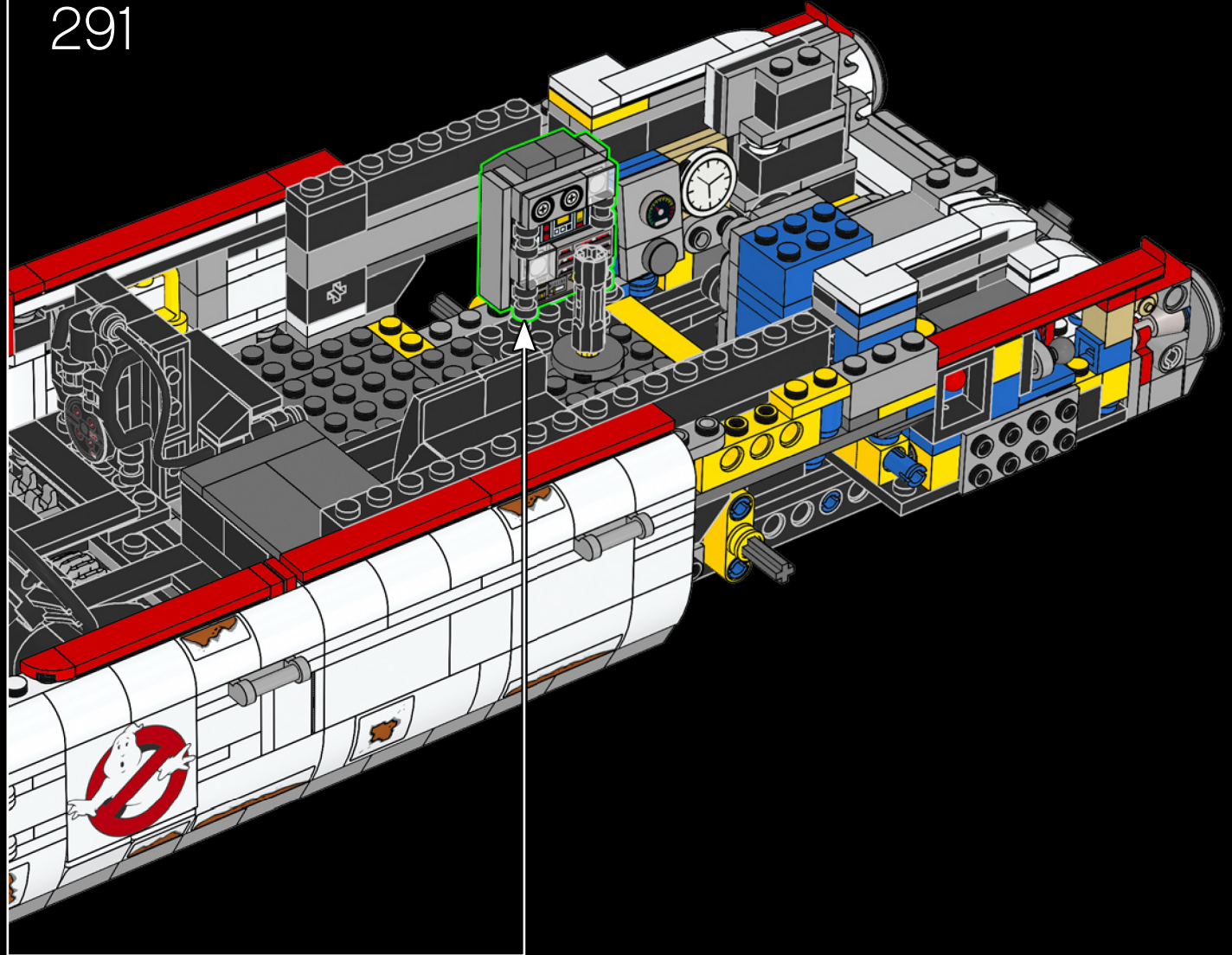

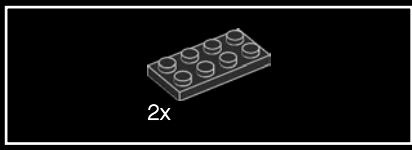

292

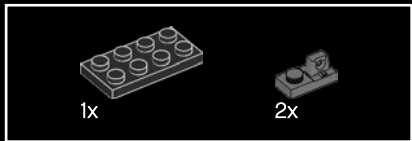
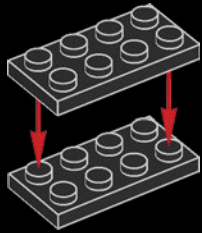

293

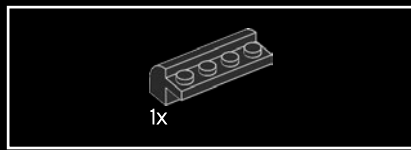
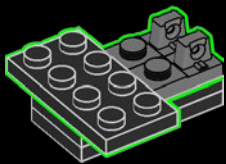

294

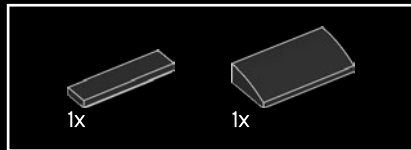
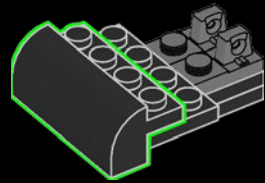

295

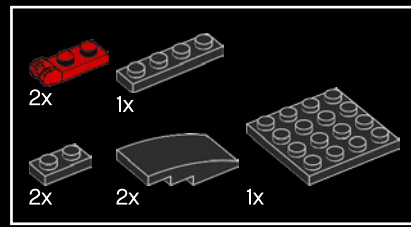
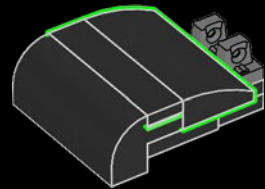

296

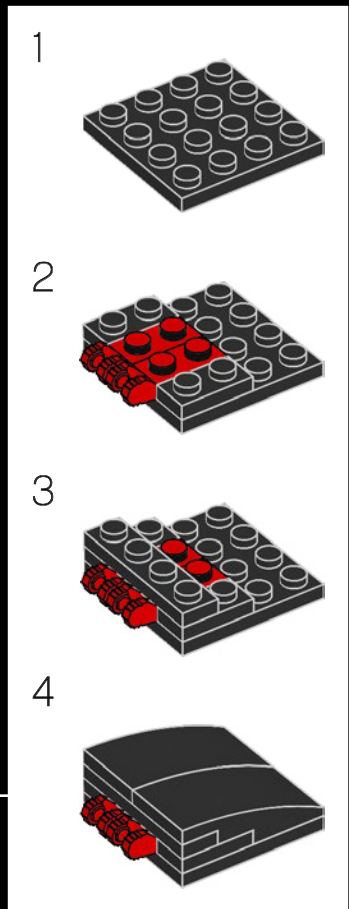
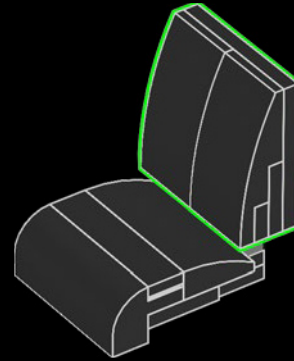

297

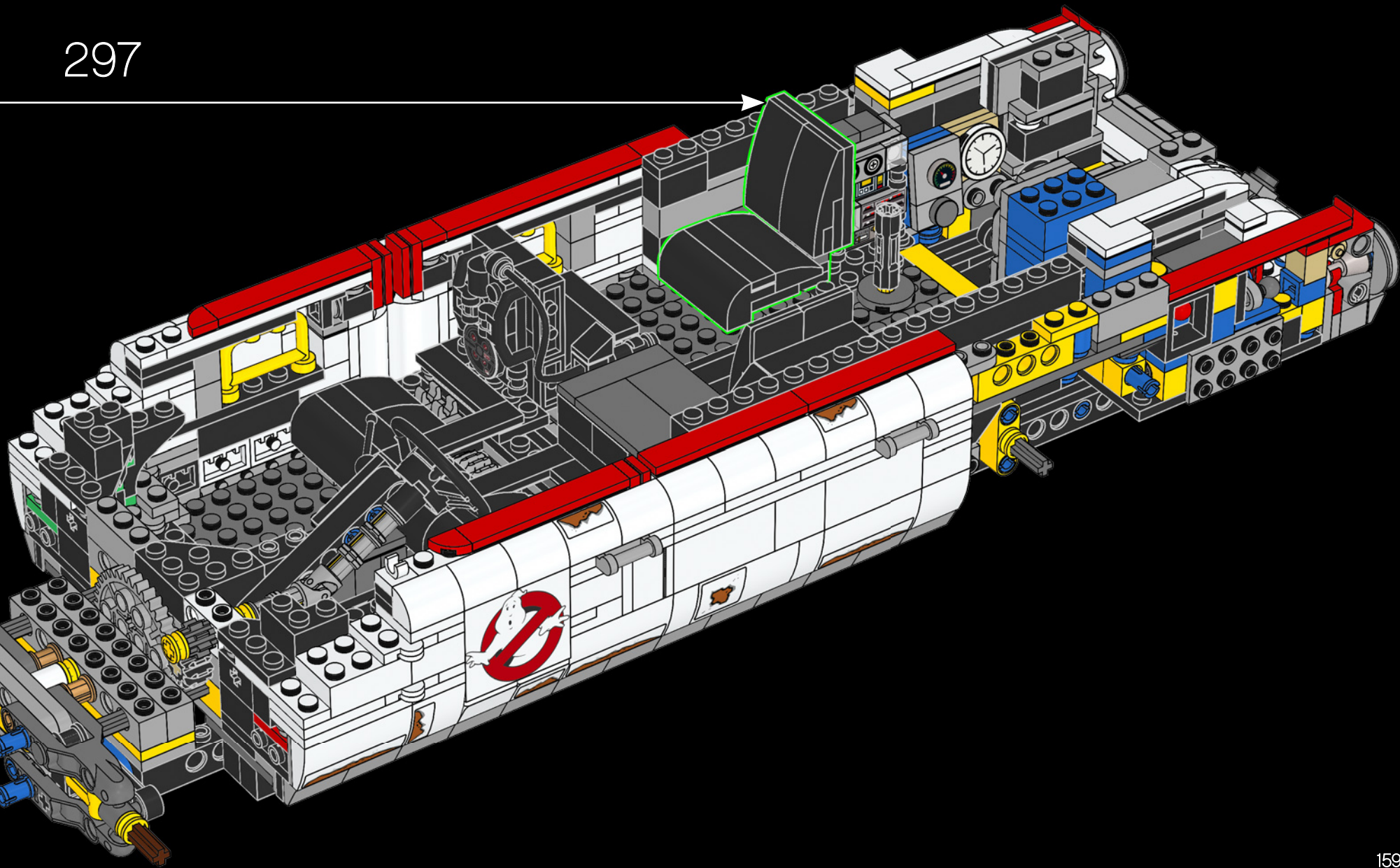

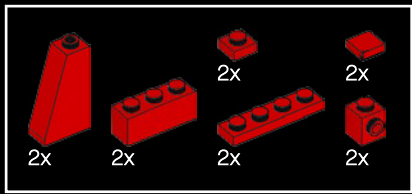

298

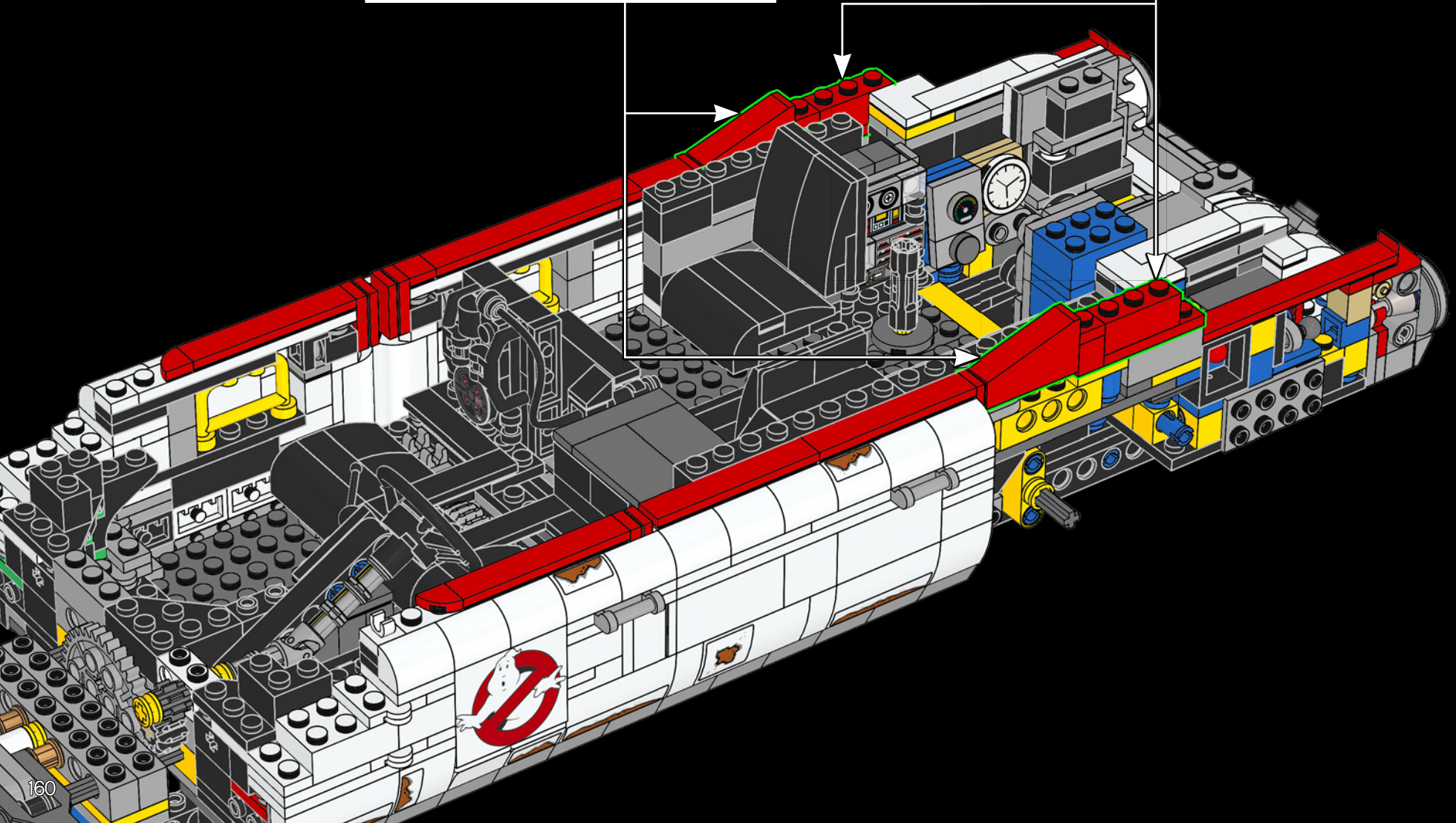
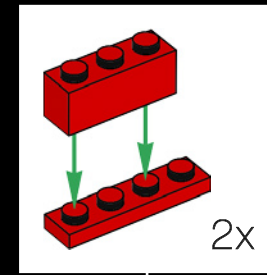
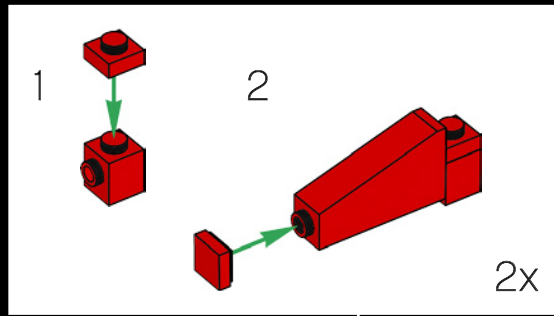



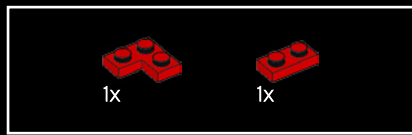

299

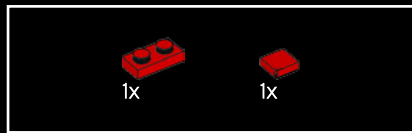
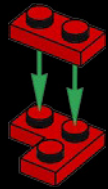

300

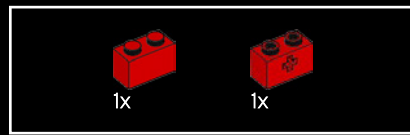
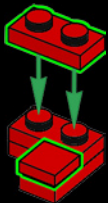

301

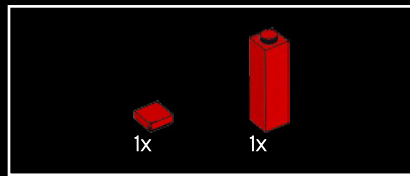
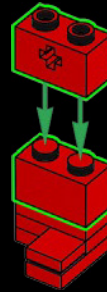

302

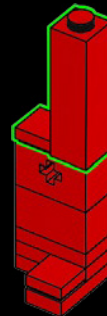

303

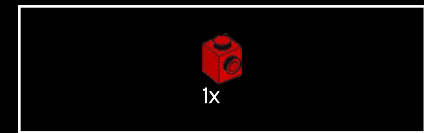

304

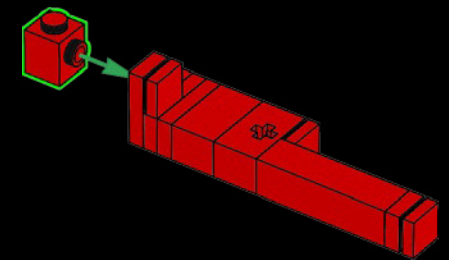

305

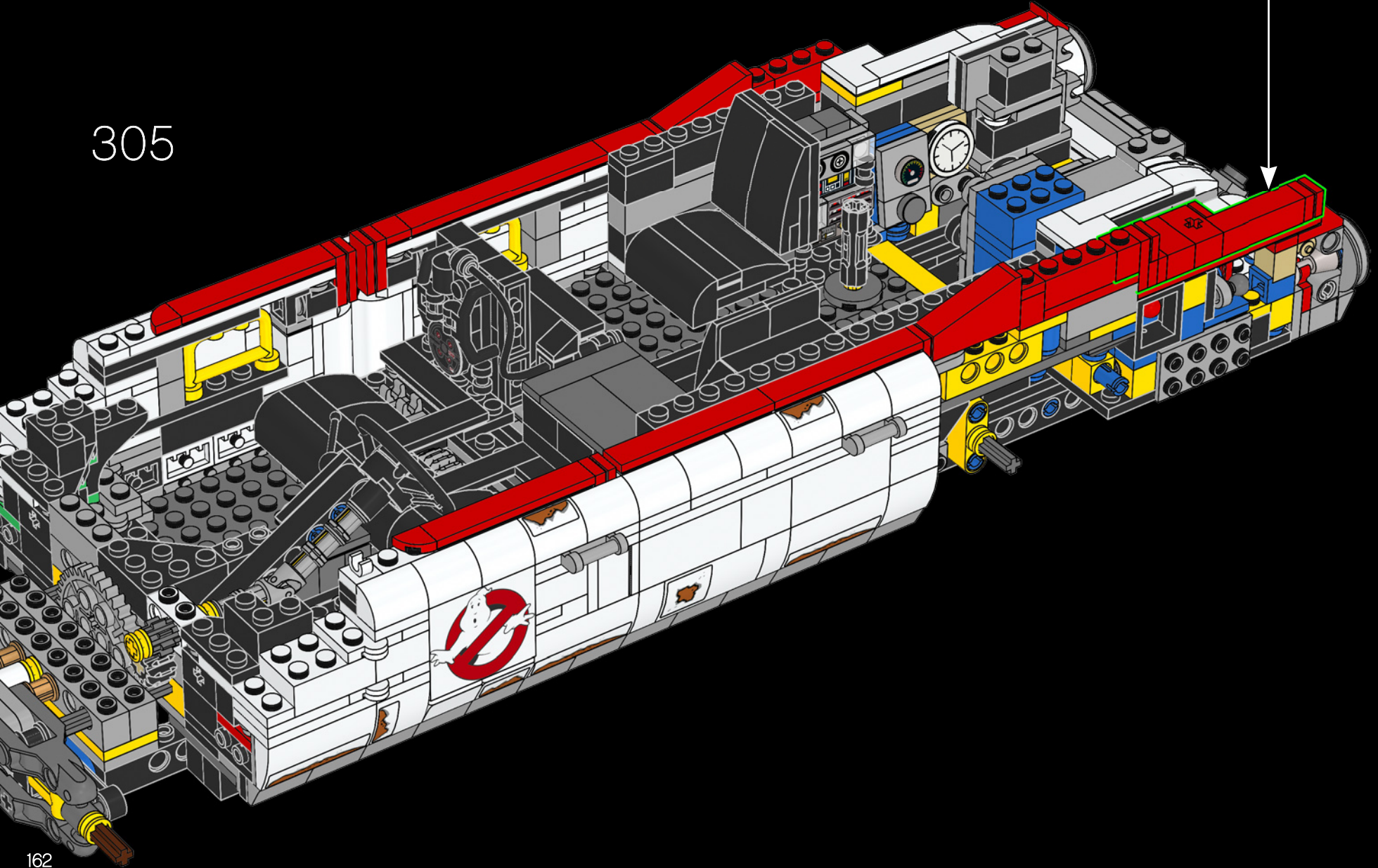

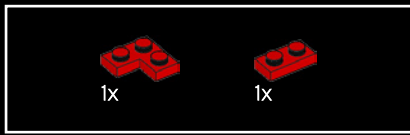

306

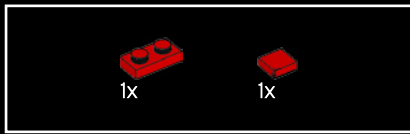
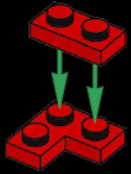

307

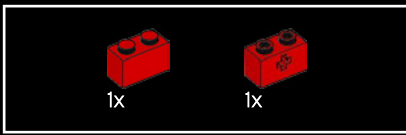
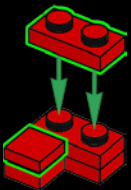

308

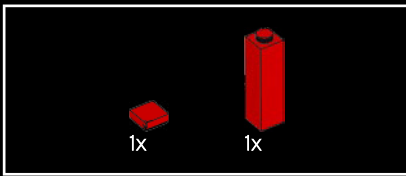
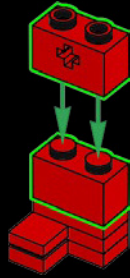

309

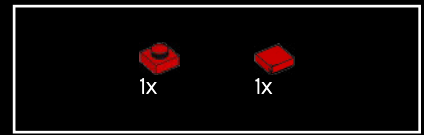
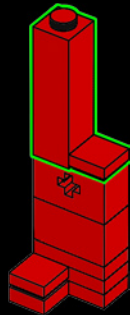

310

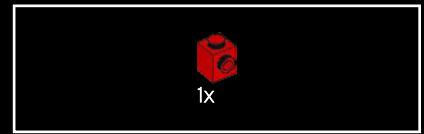
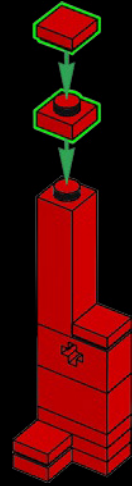

311

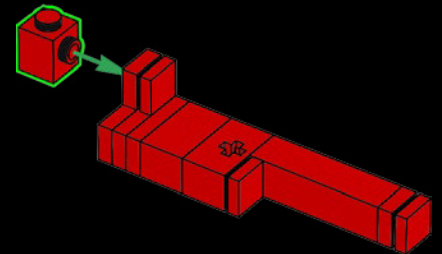

312

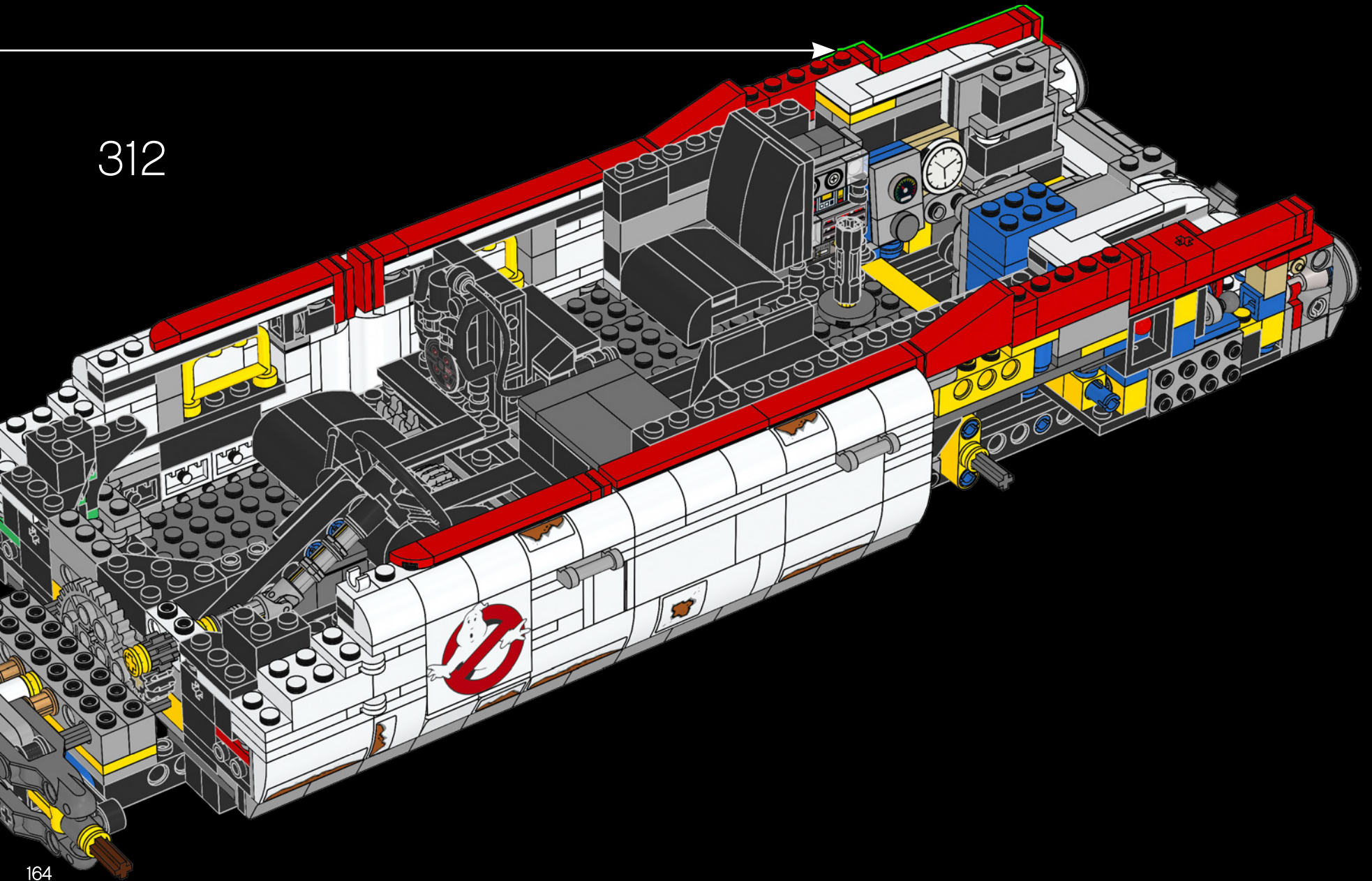

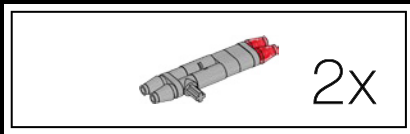

313

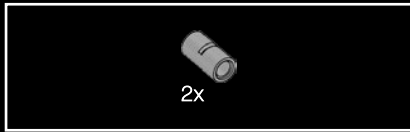
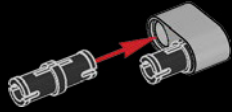

314

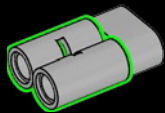

315

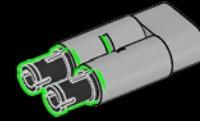

316

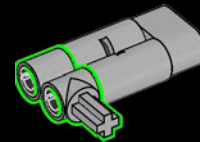



317

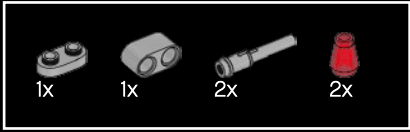
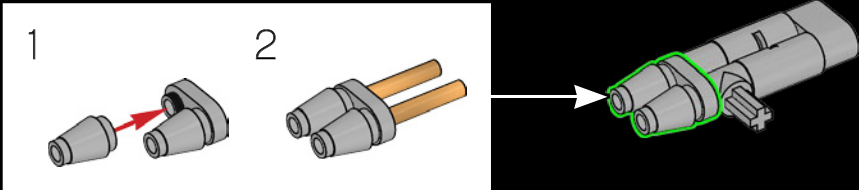

318

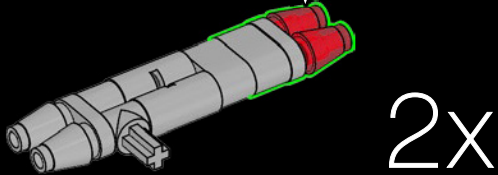
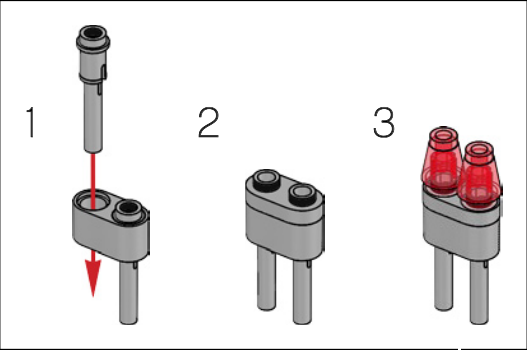

319

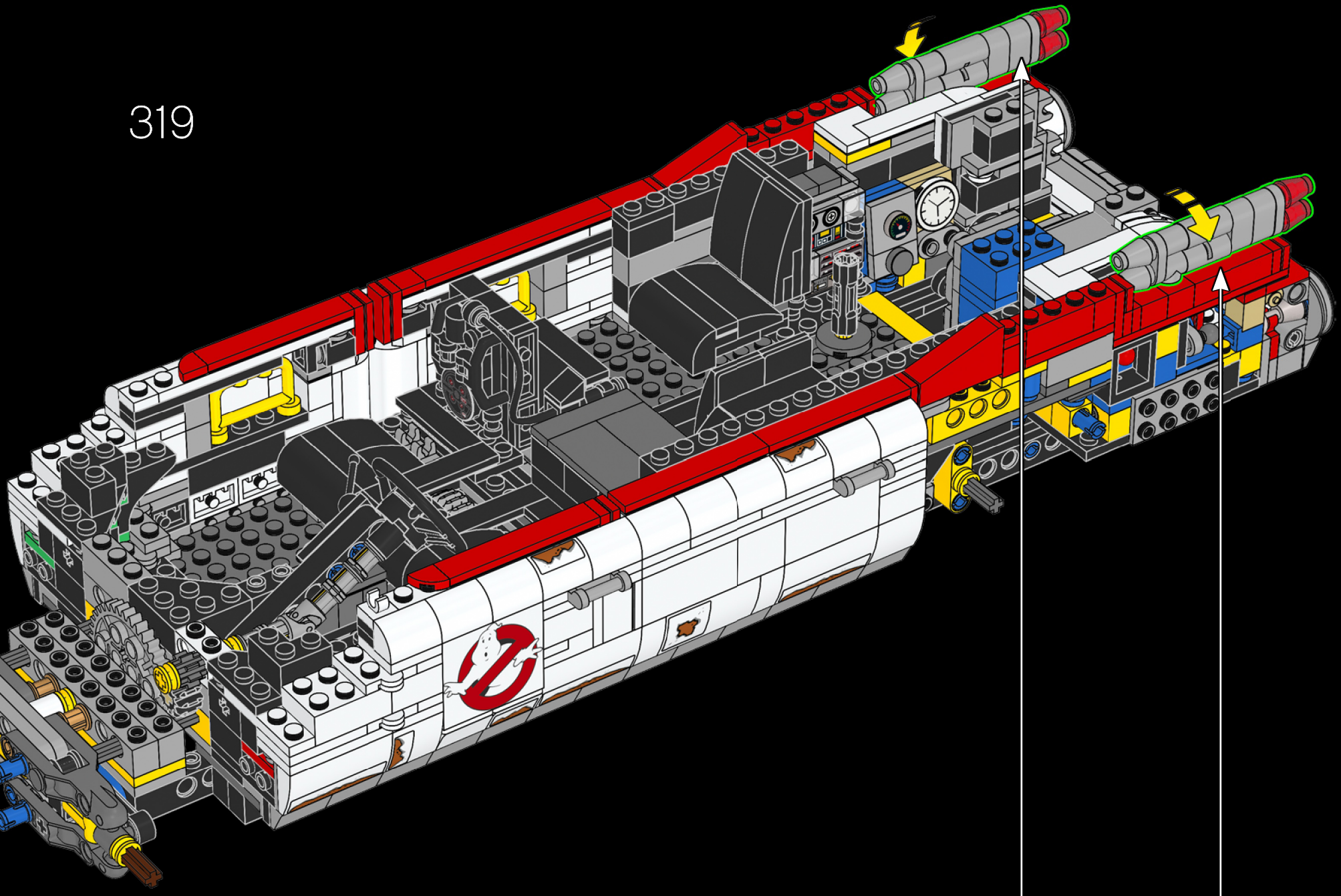

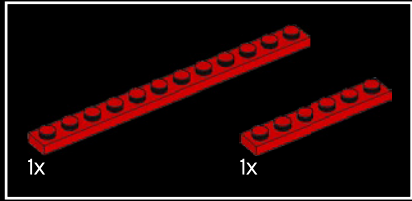
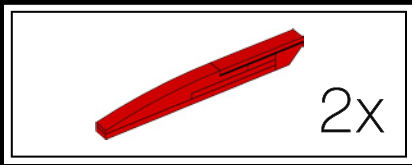

320

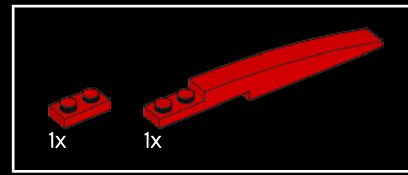
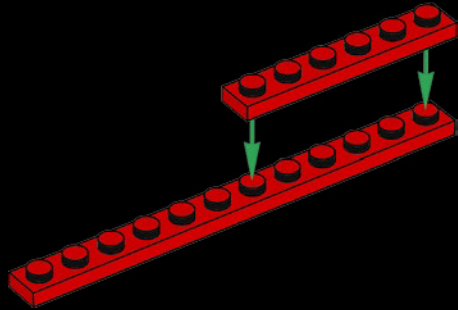

321

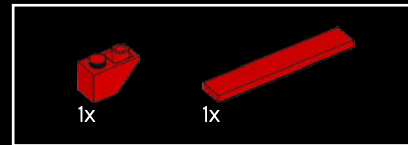
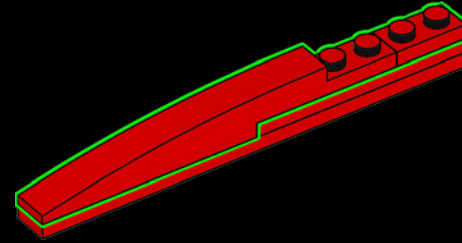

322

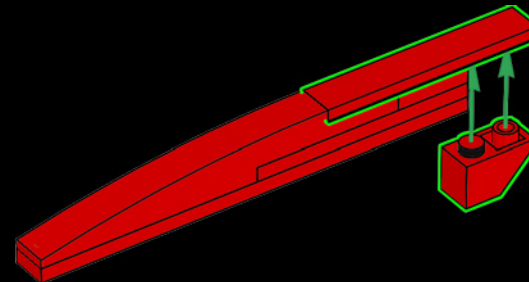



323

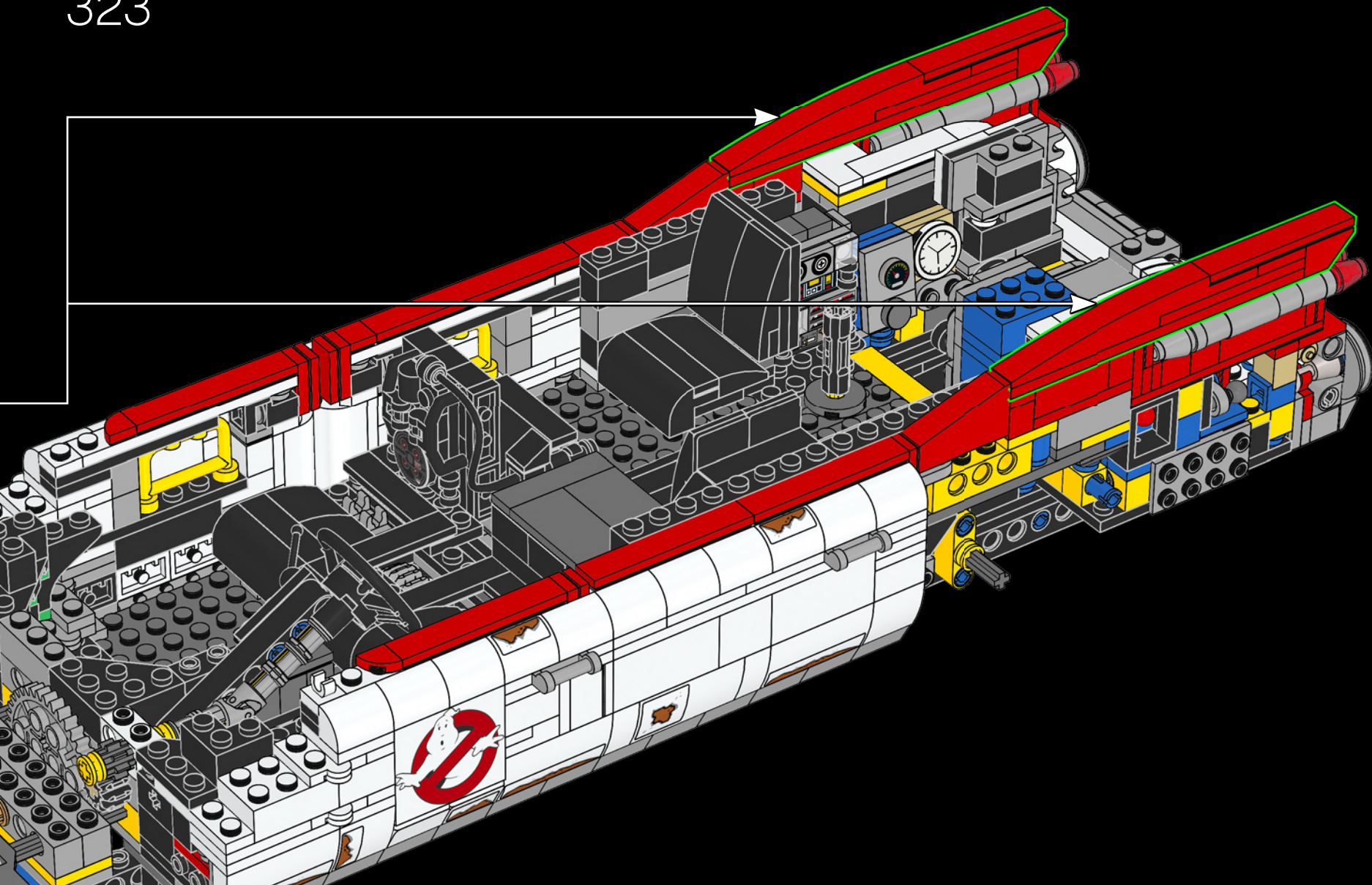

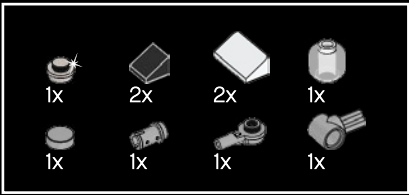
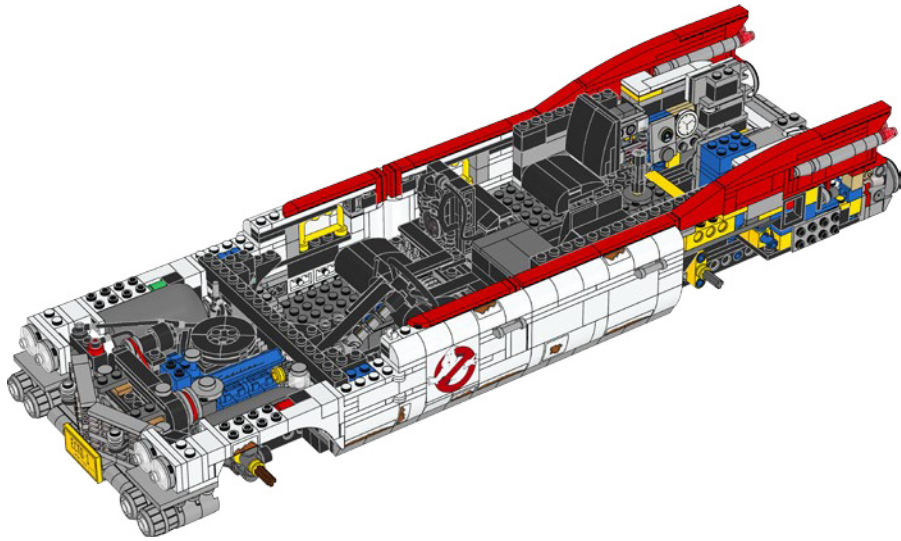
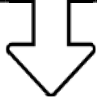

324

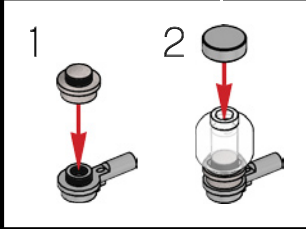
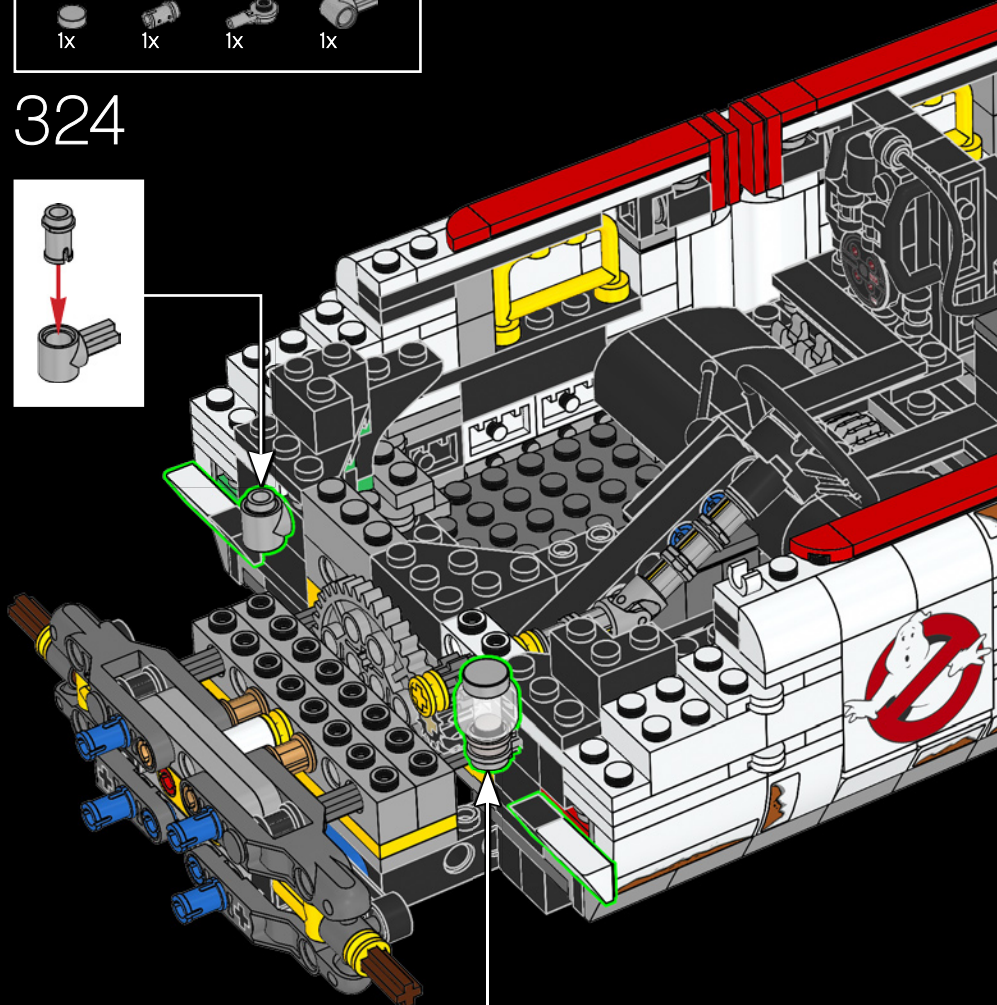
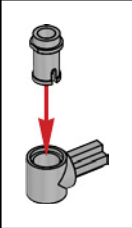

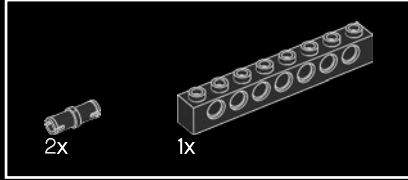
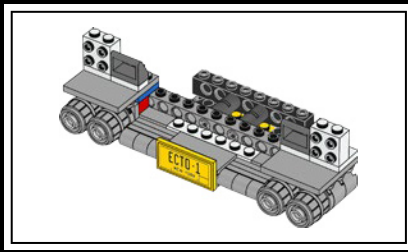

325

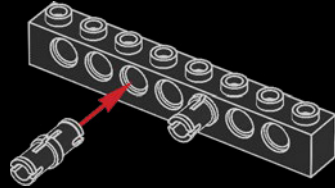

326

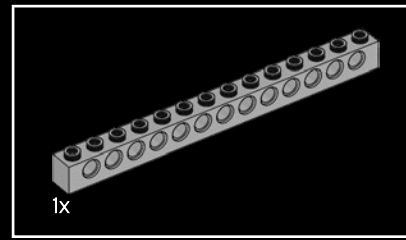
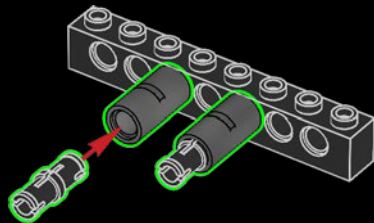

327

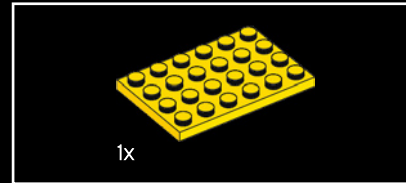
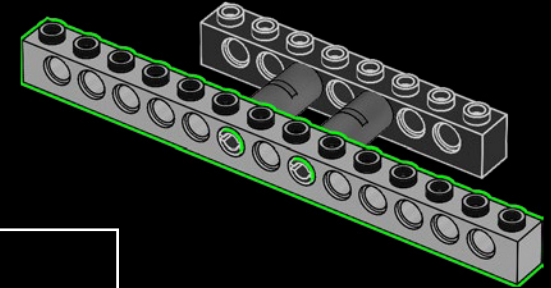

328

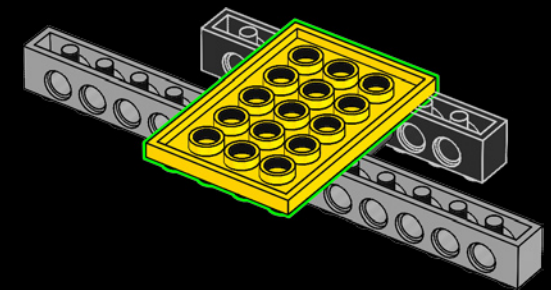

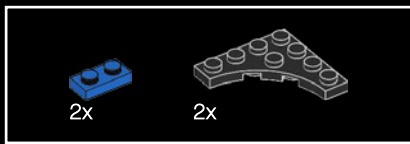

329

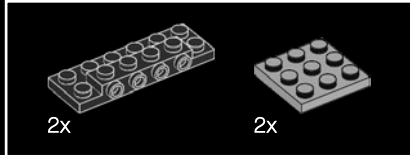
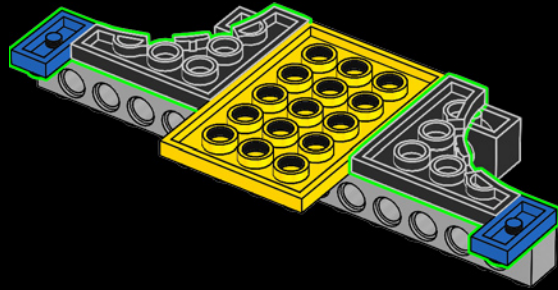

330

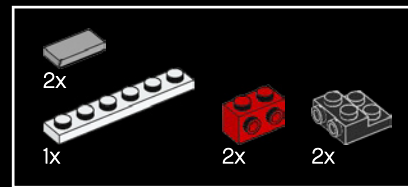
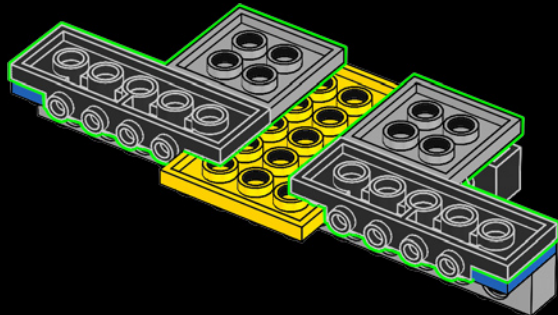

331

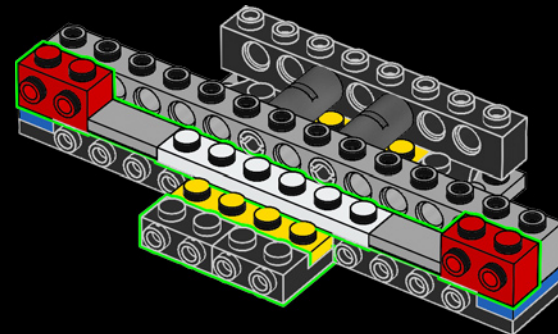

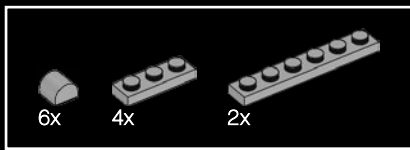

332

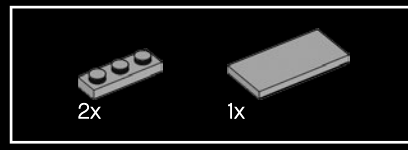
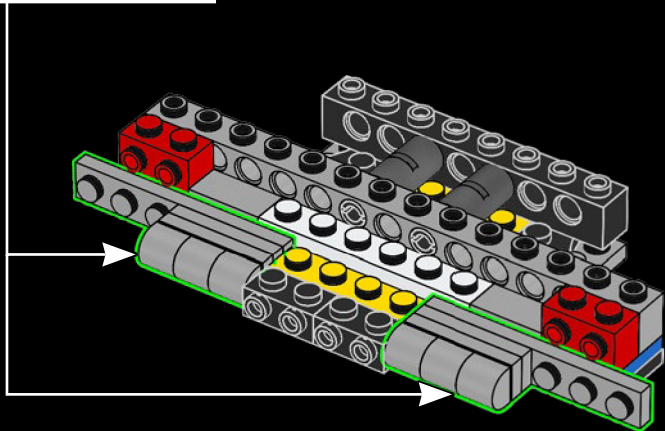
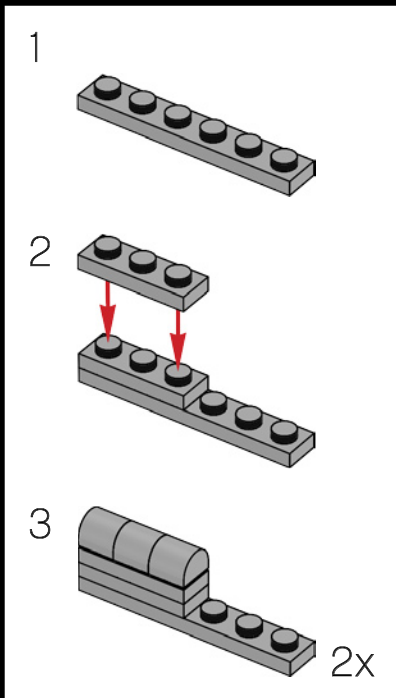

333

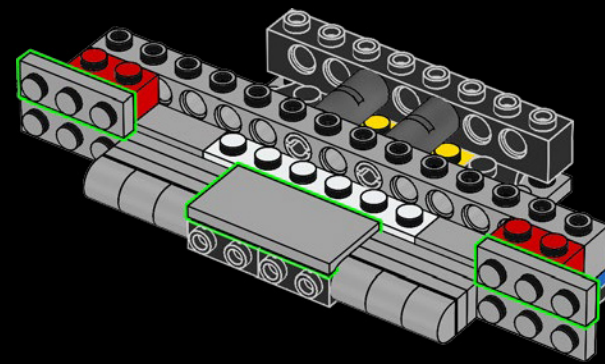

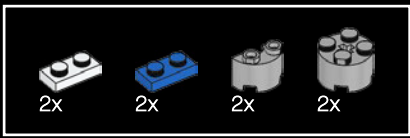

334

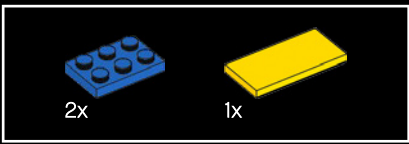
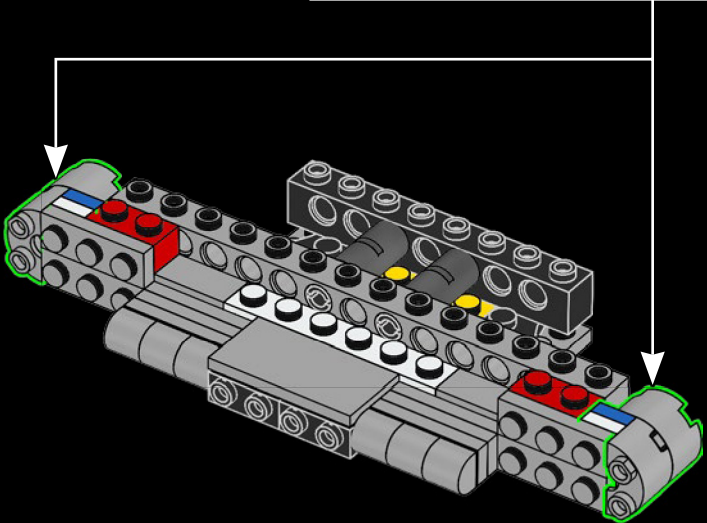
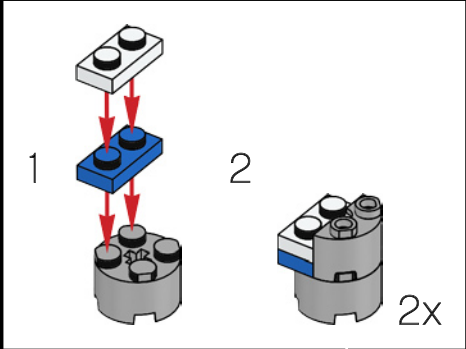

335

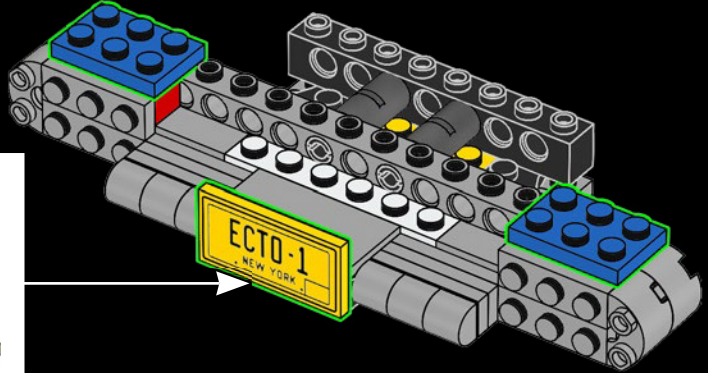
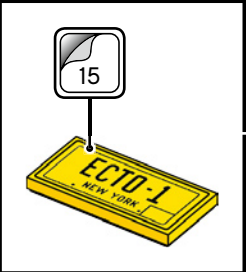



336

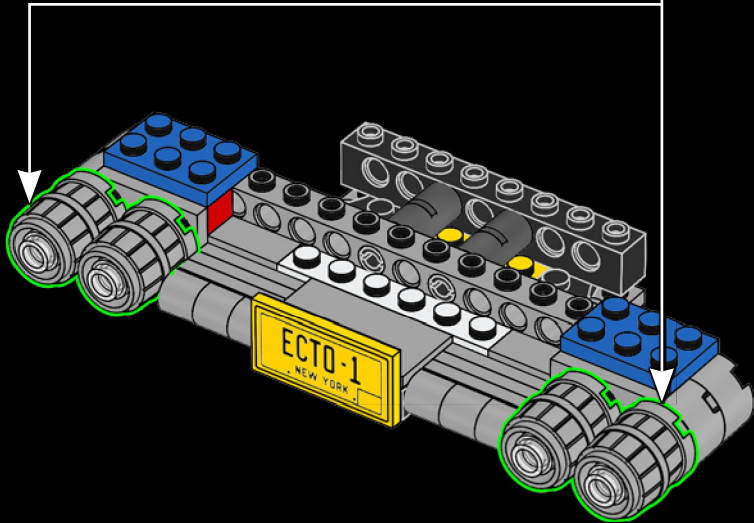
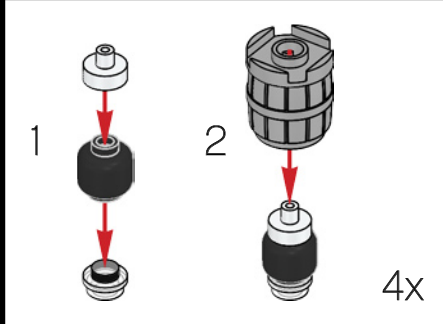

337

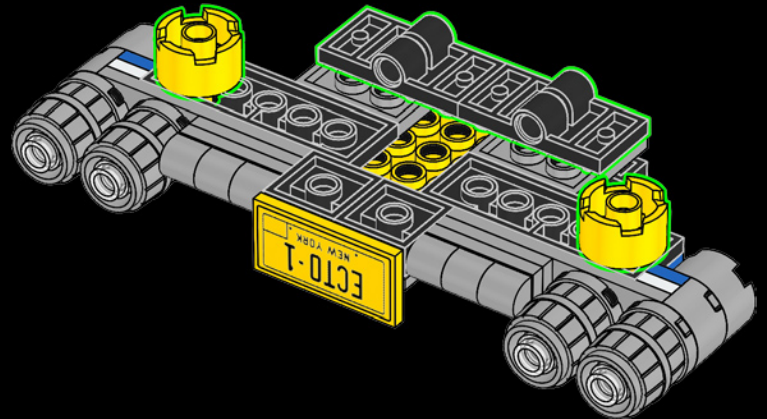

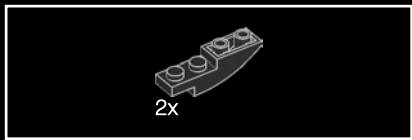

338

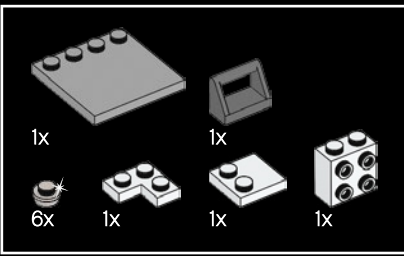

339

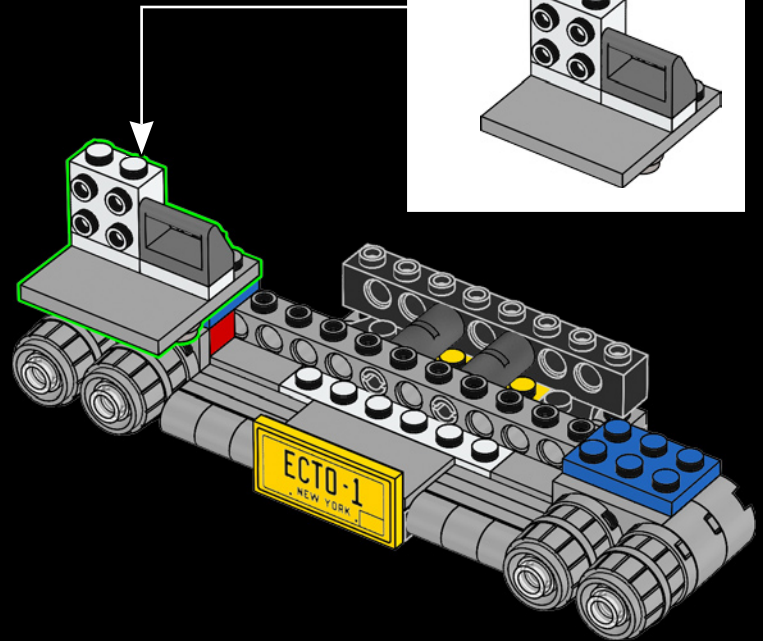
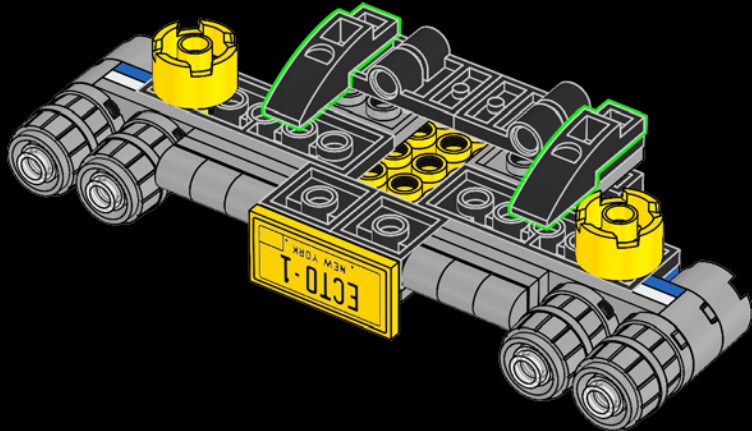
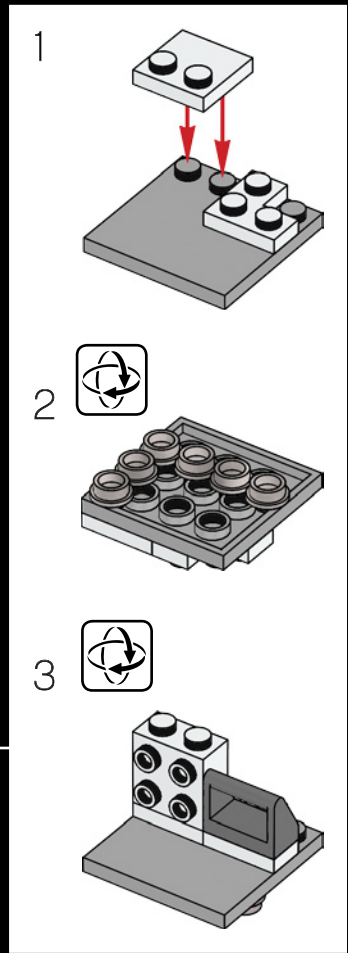



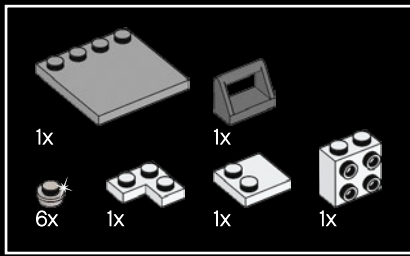

340

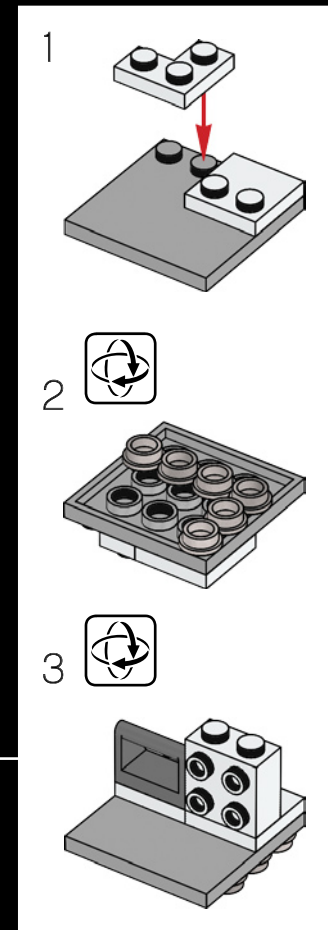
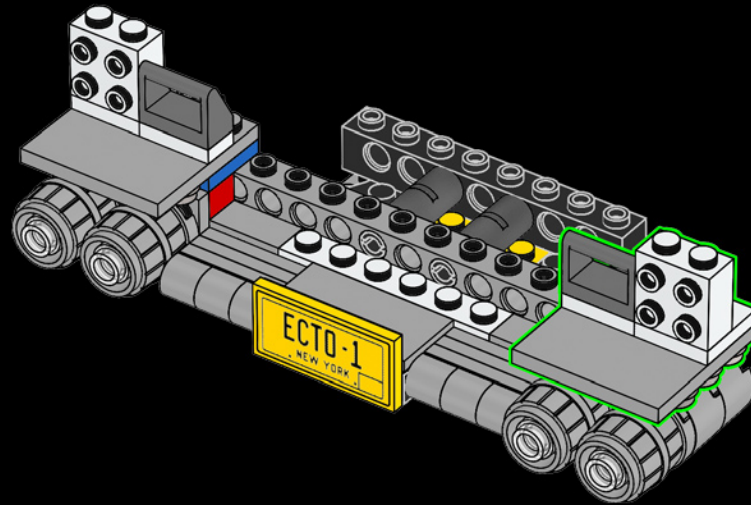

341

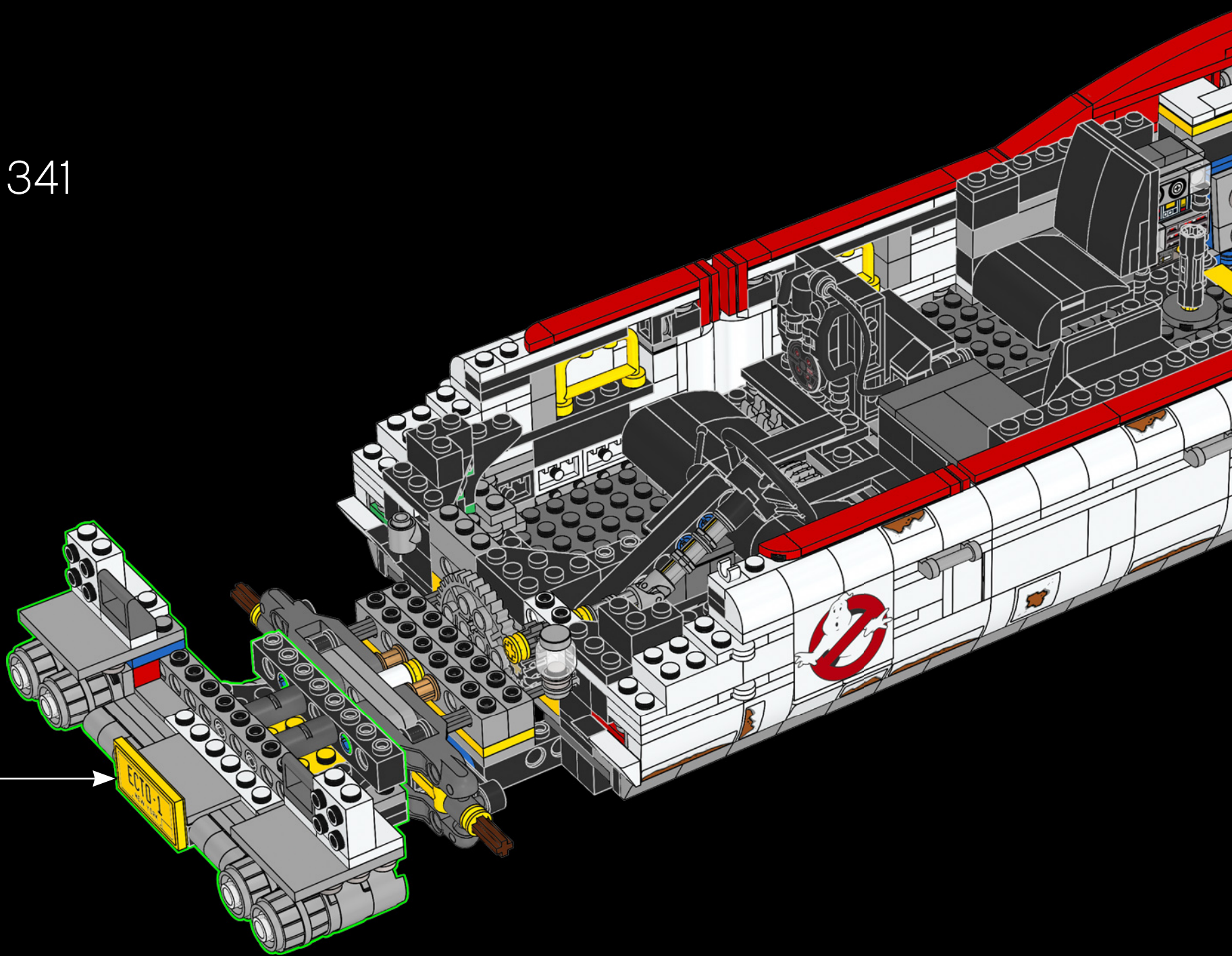

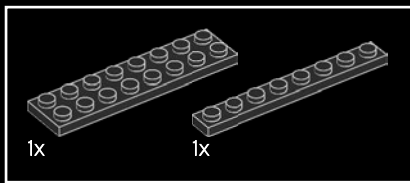

342

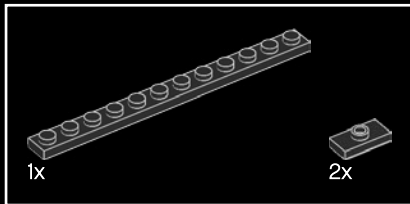
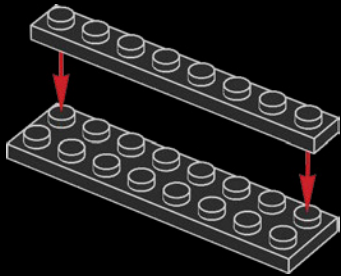

343

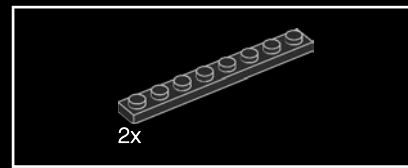
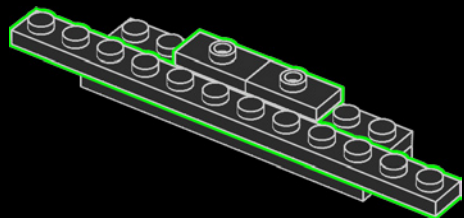

344

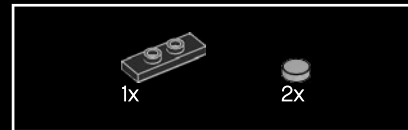
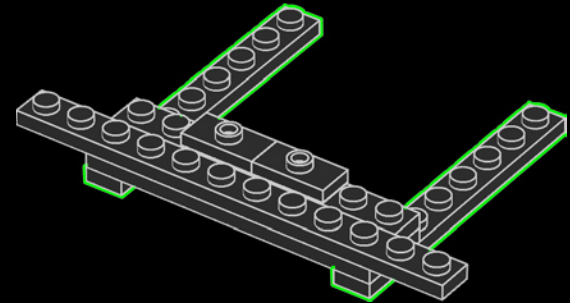

345

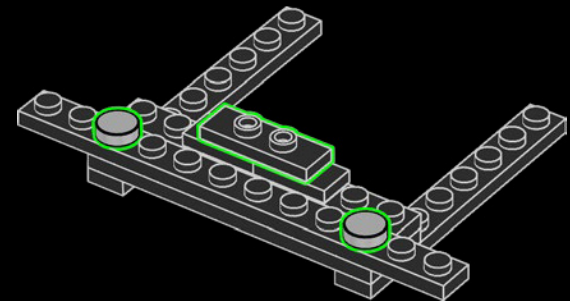

346

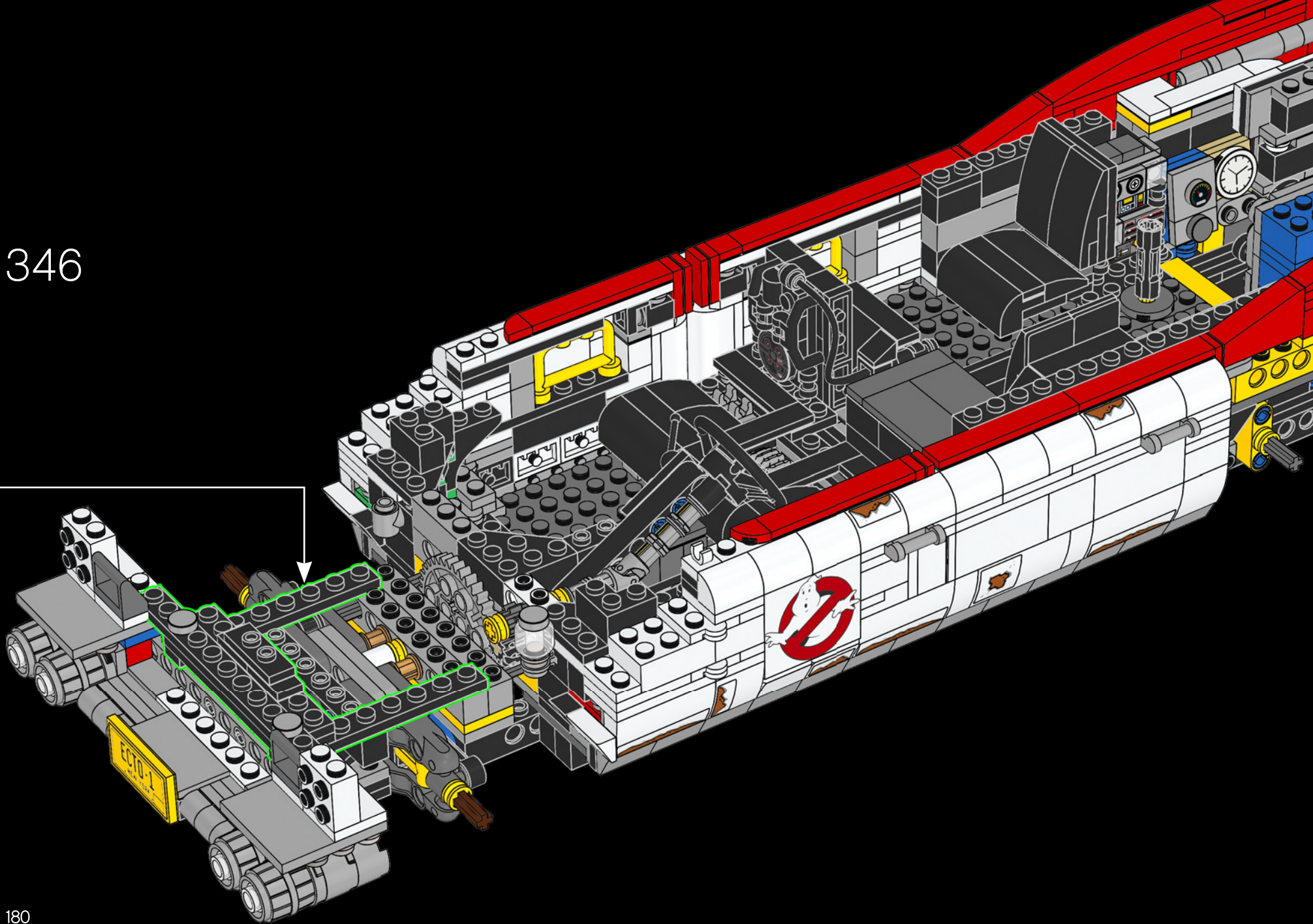

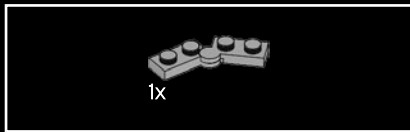
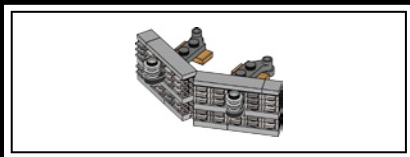

347

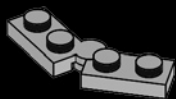

348

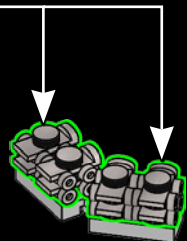
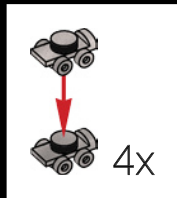

349

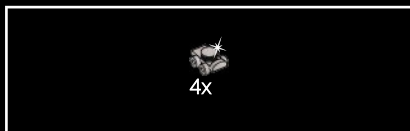
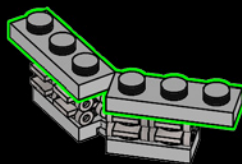

350

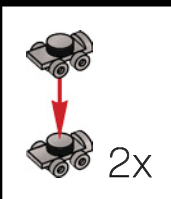
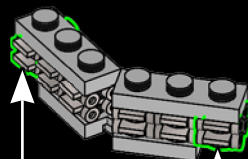

351

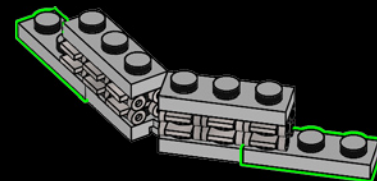

352

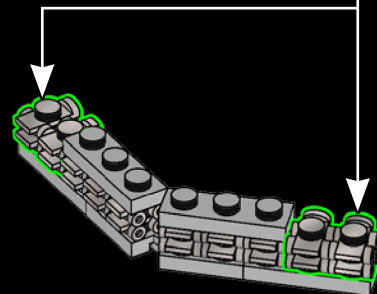
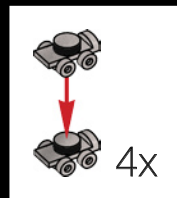

2x

353

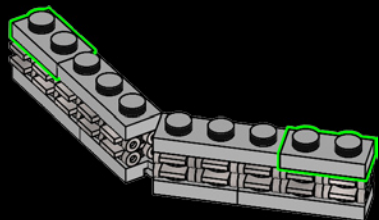

2x 4x

355

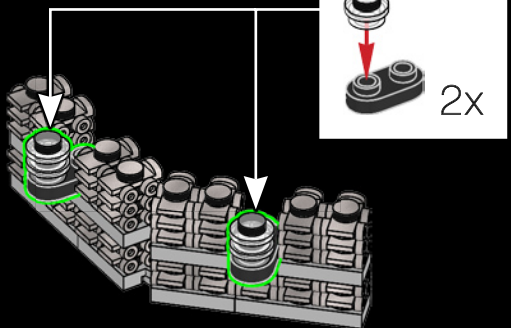

2x 2x

357

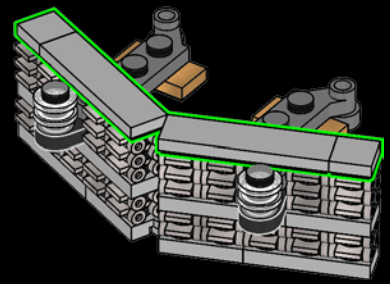

24x

354

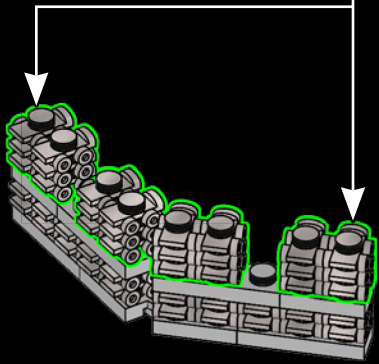
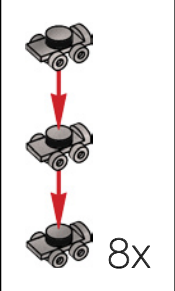

2x 2x

356

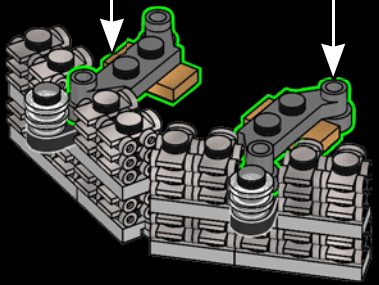
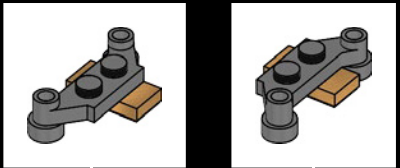

358

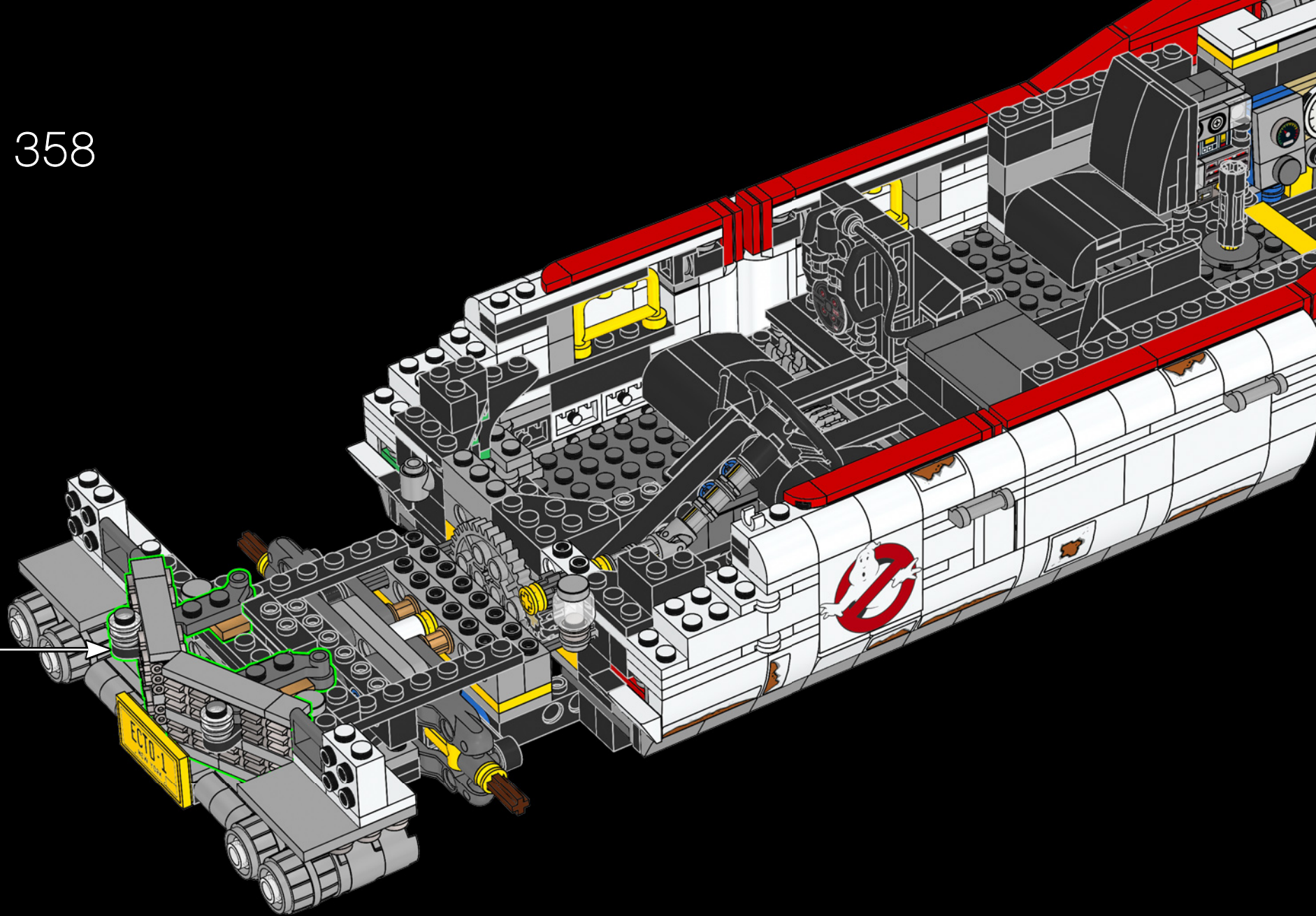

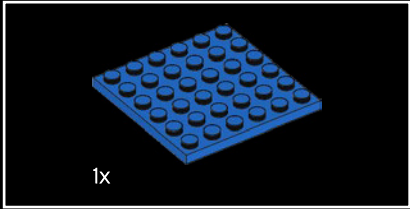
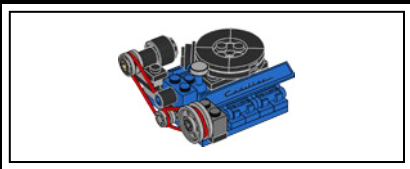

359

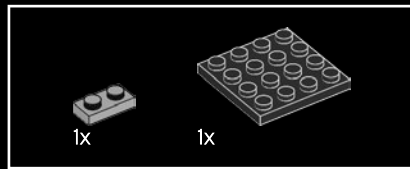
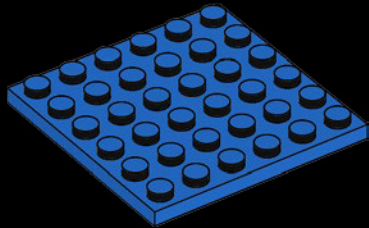

360

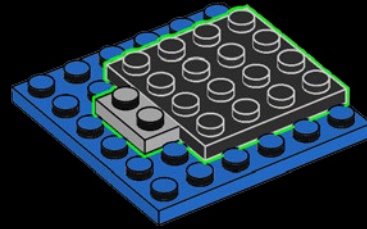

361

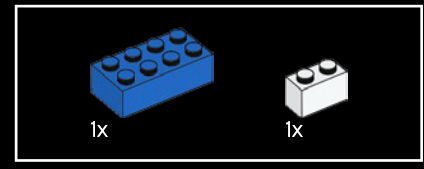
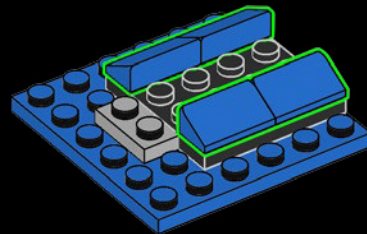

362

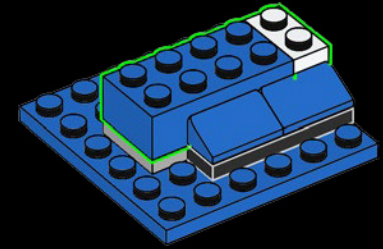

363

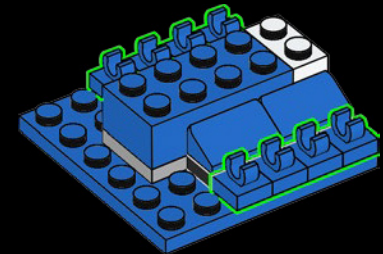



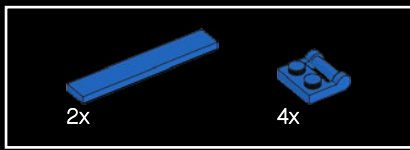

364

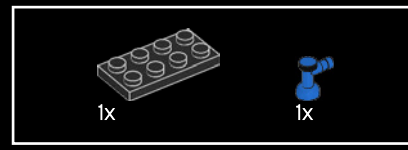
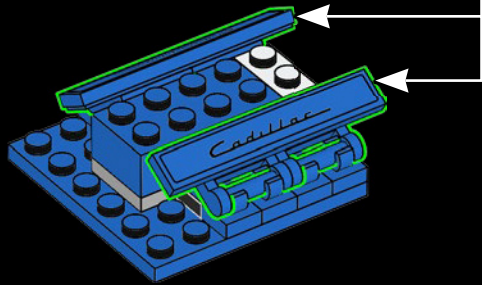
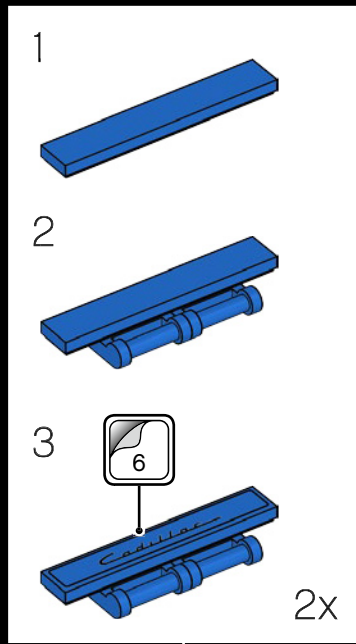

365

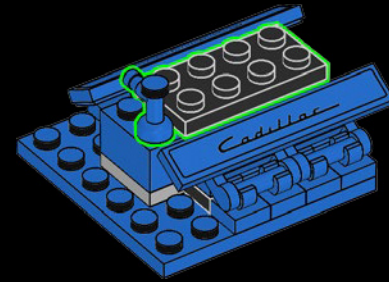

366

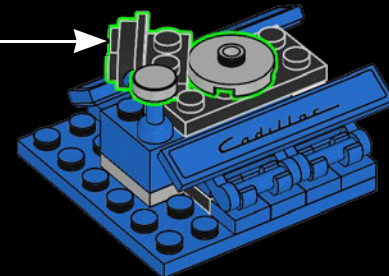
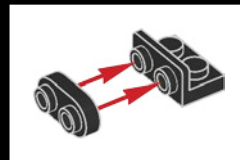

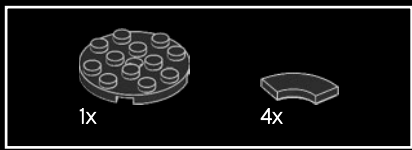

367

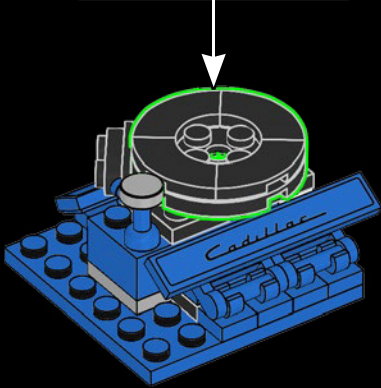
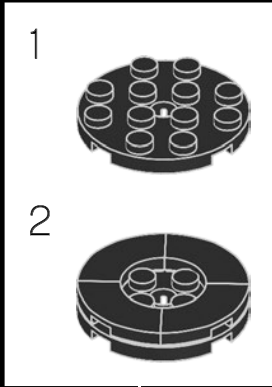

368

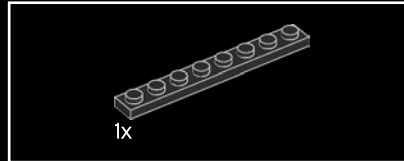
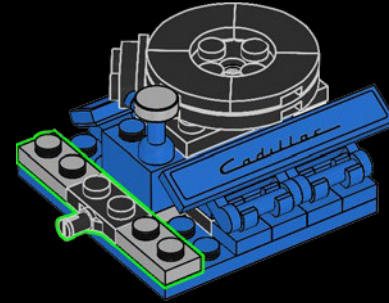

369

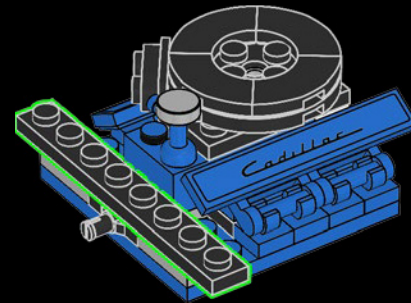

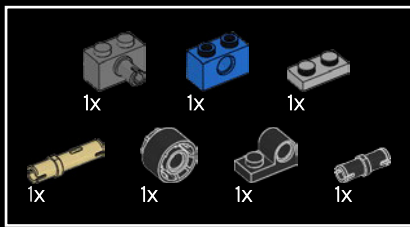

370

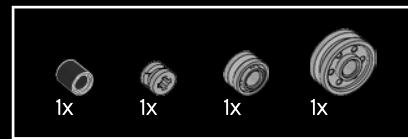
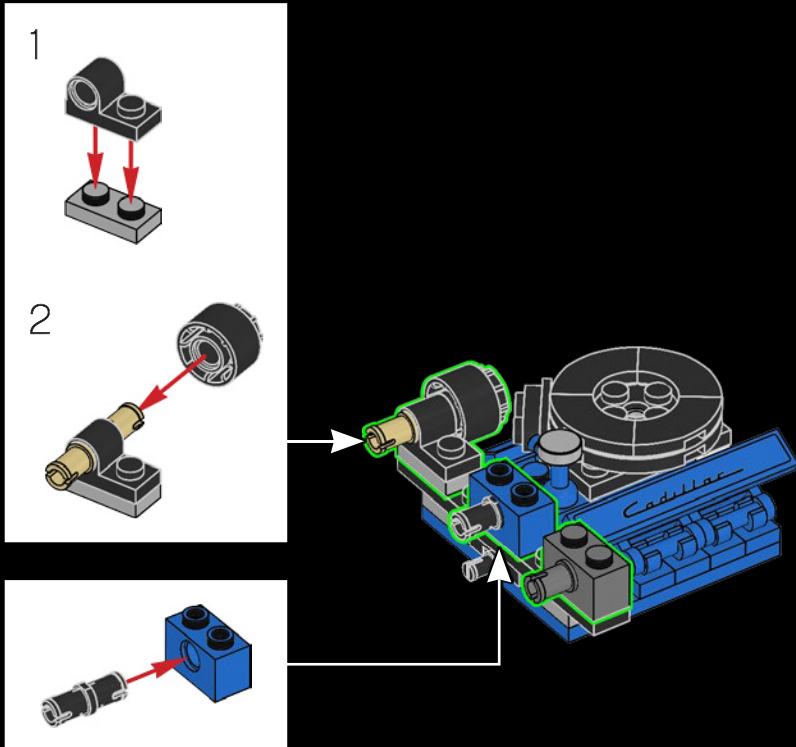

371

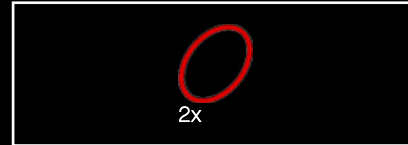
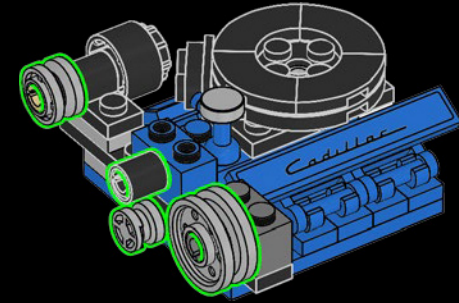

372

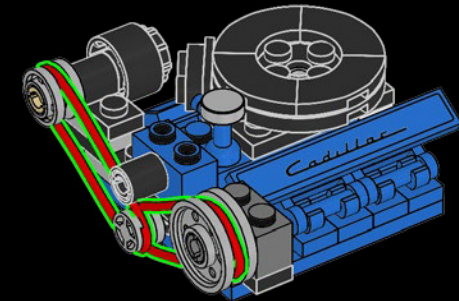

373

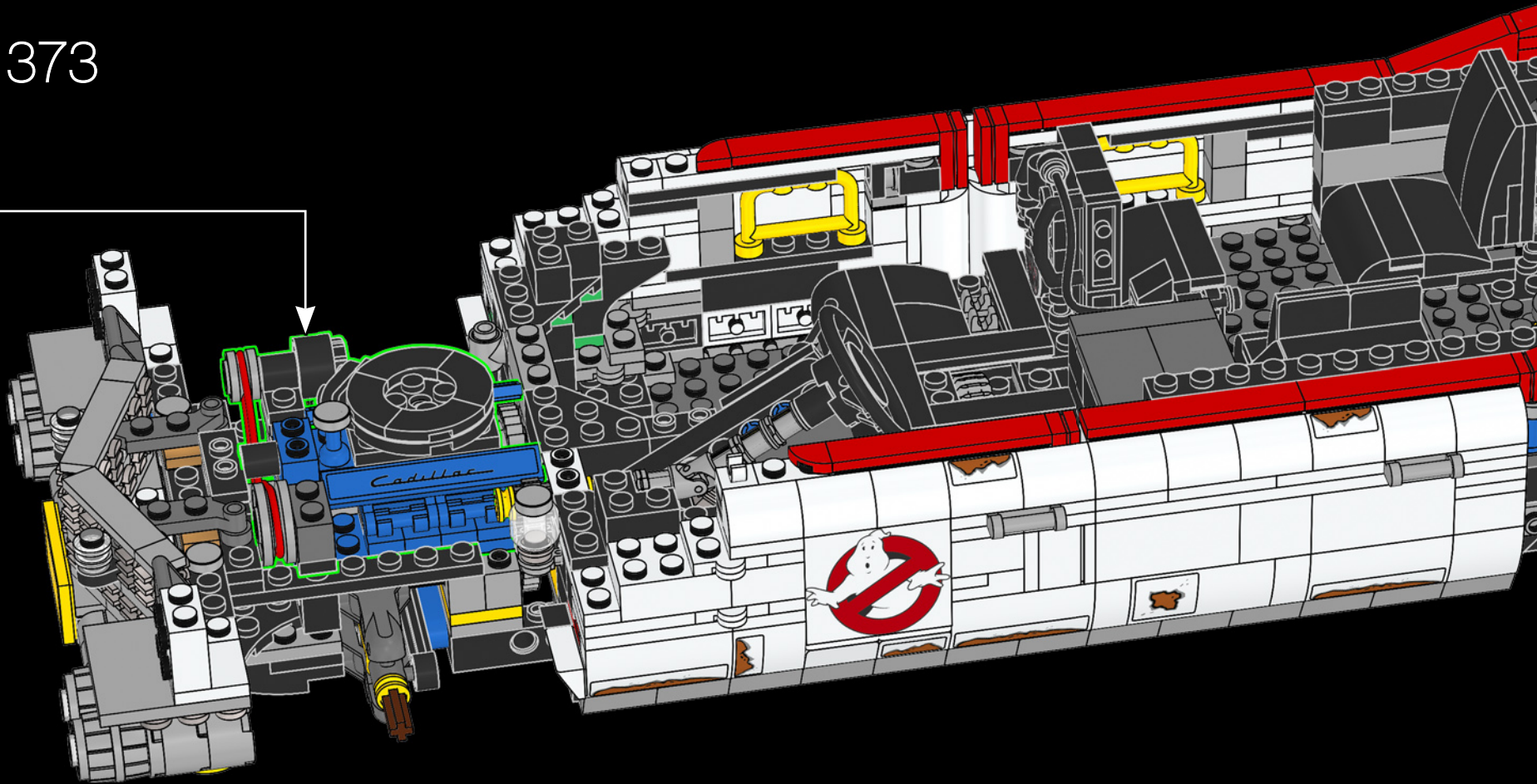

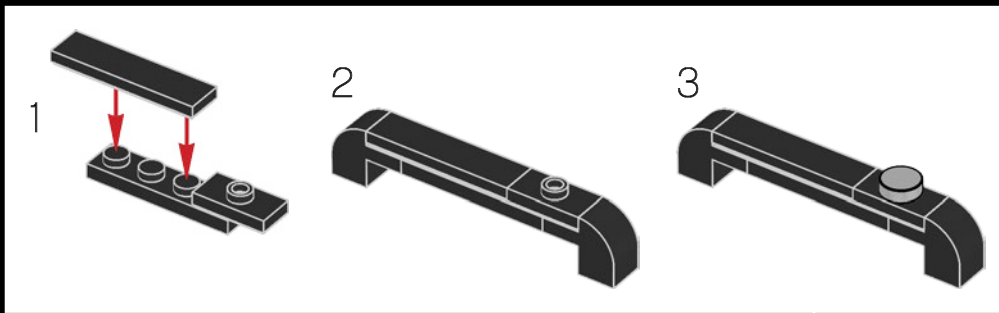
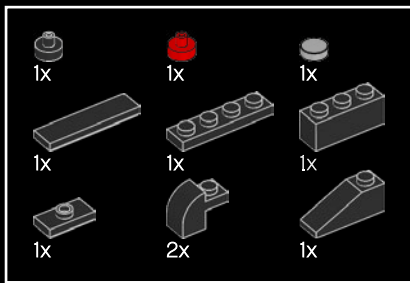

374

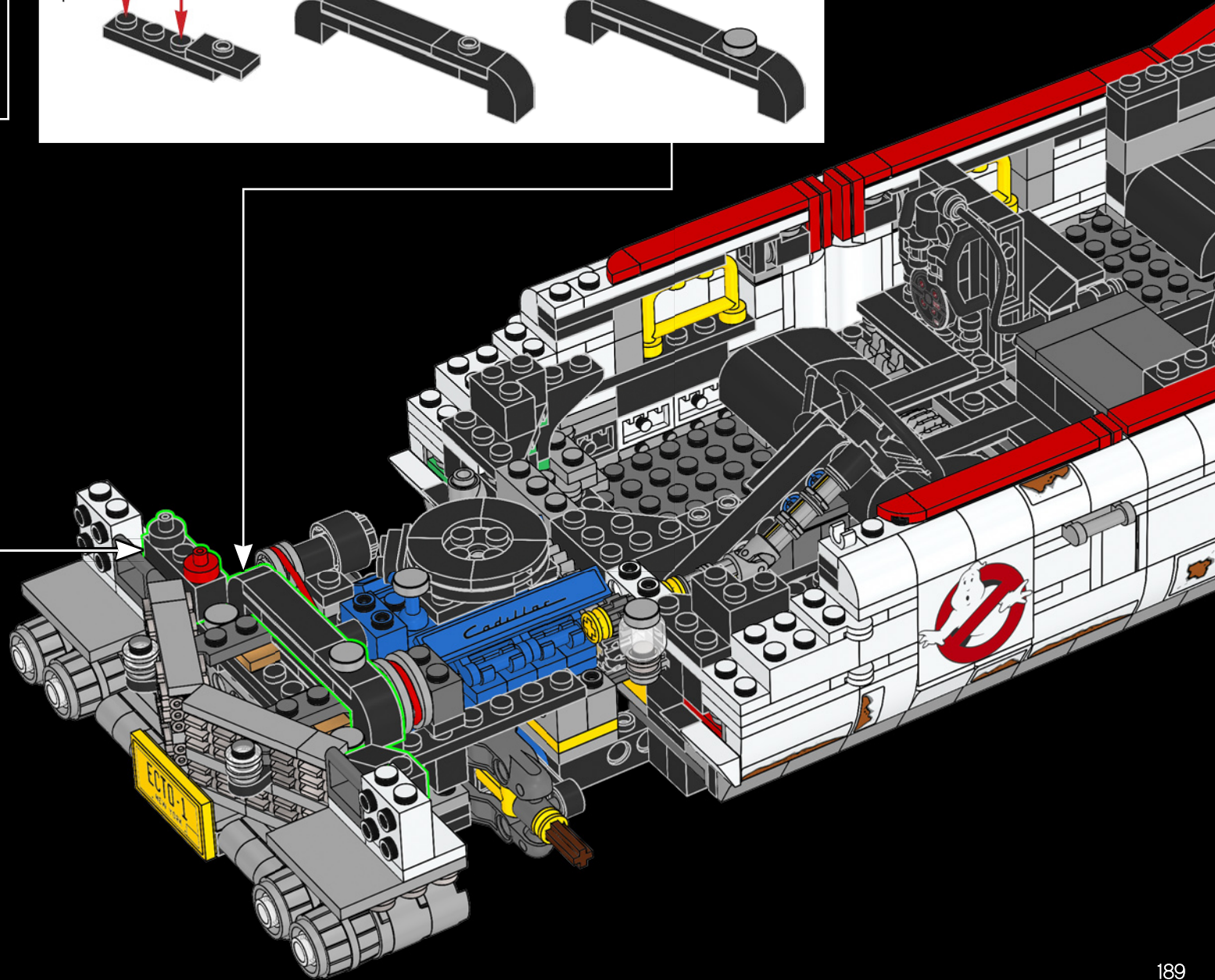
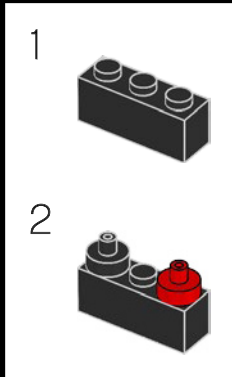

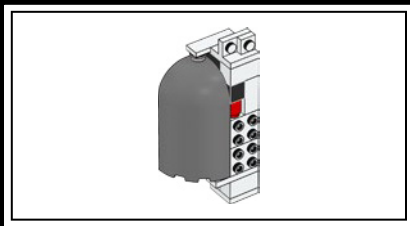

375

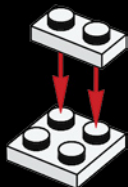

376

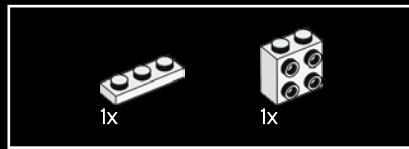
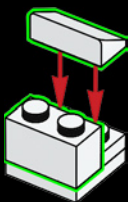

377

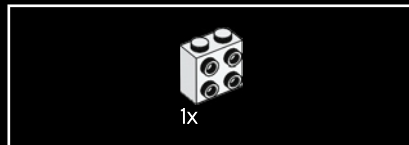
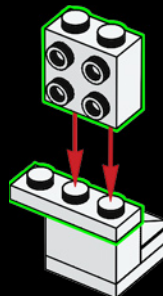

378

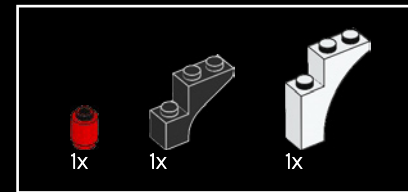
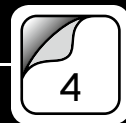
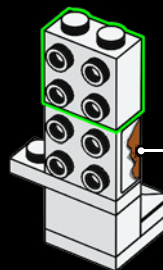

379

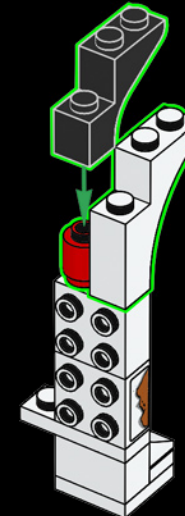

380

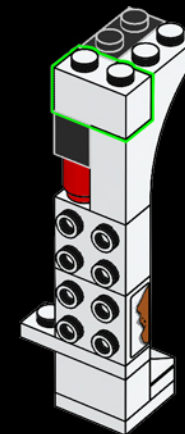

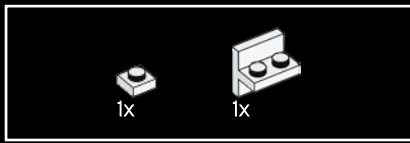

381

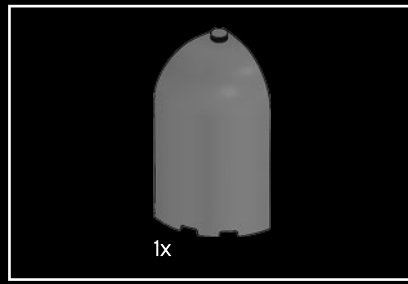
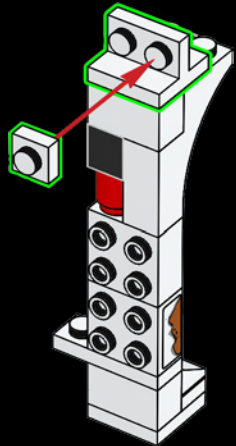

382

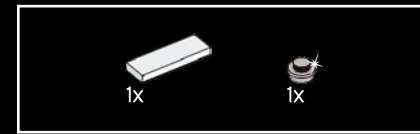
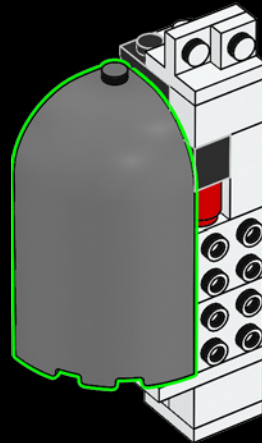

383

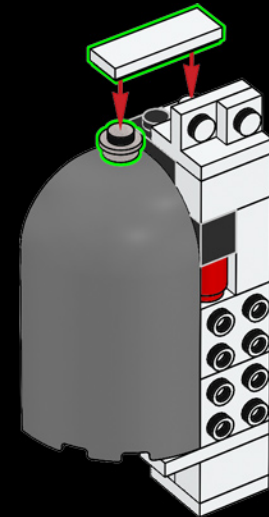

384

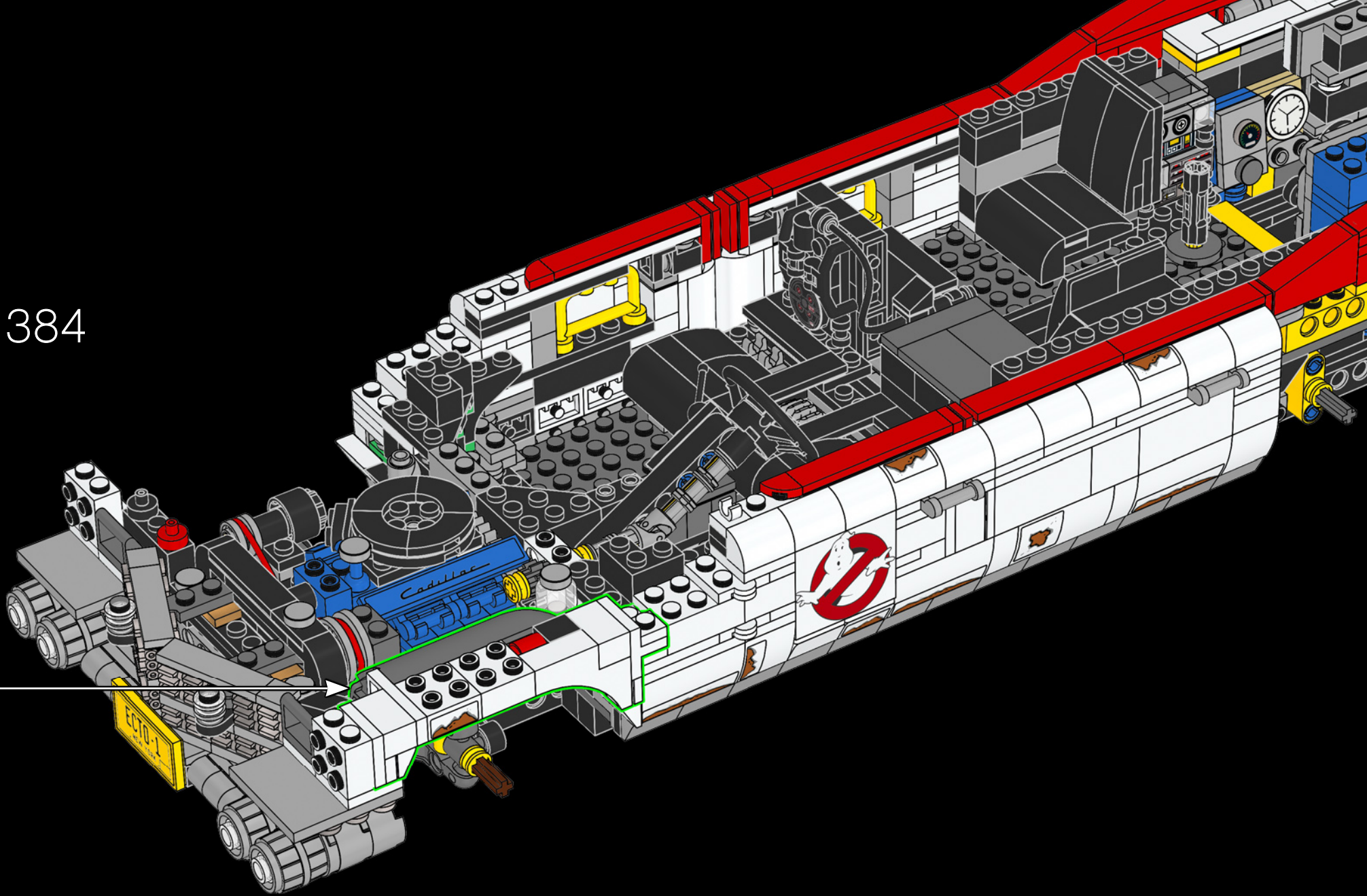



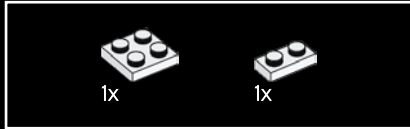
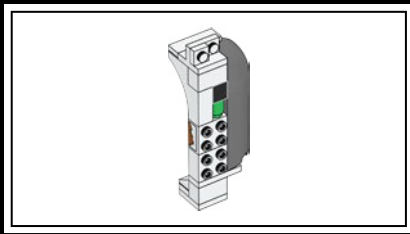

385

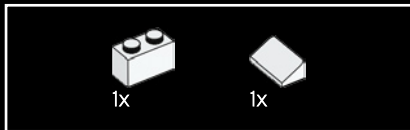
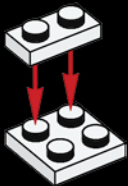

386

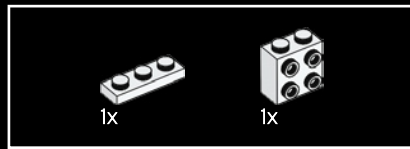
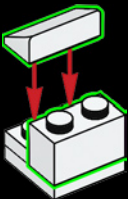

387

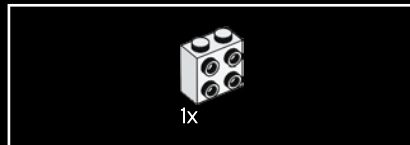
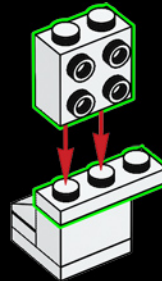

388

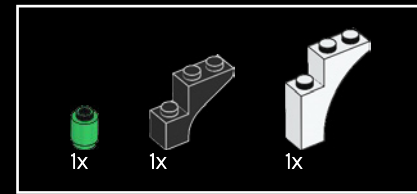
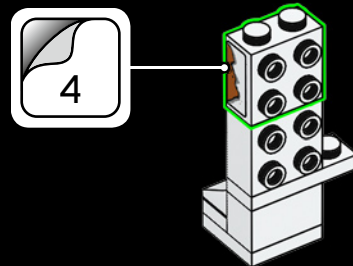

389

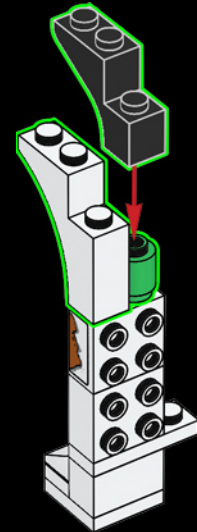

390

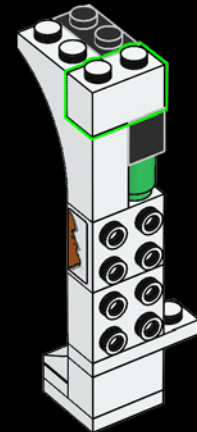

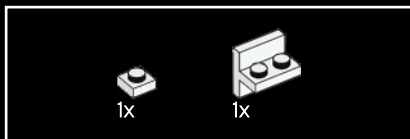

391

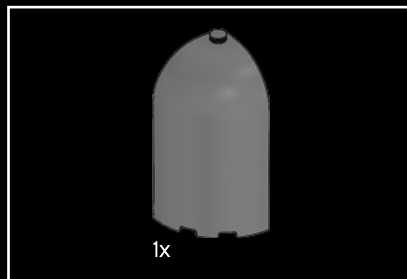
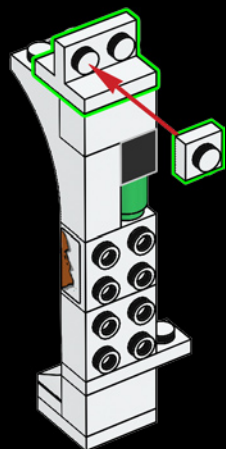

392

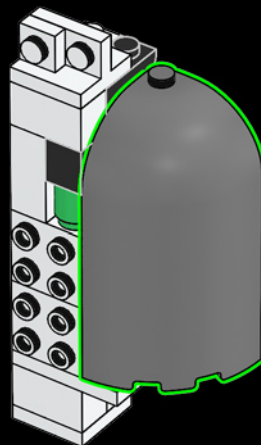

393

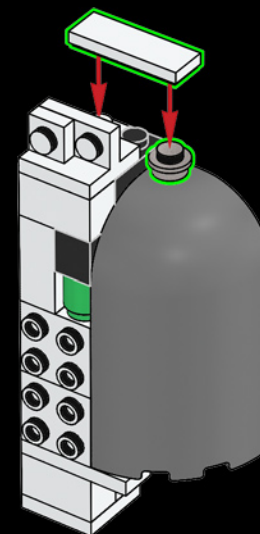

394

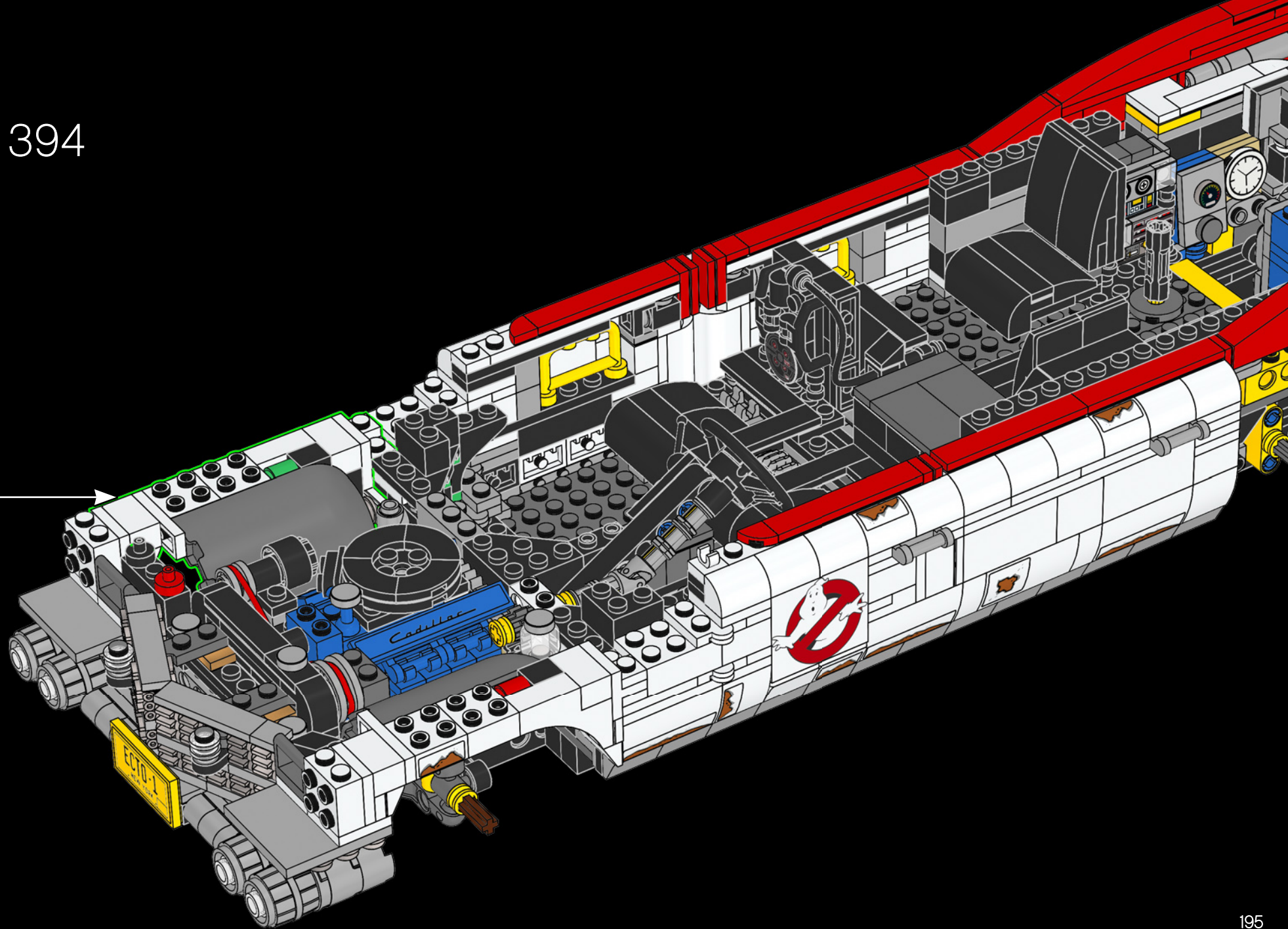

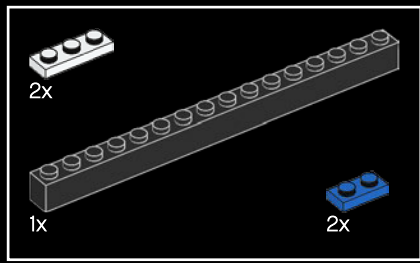

395

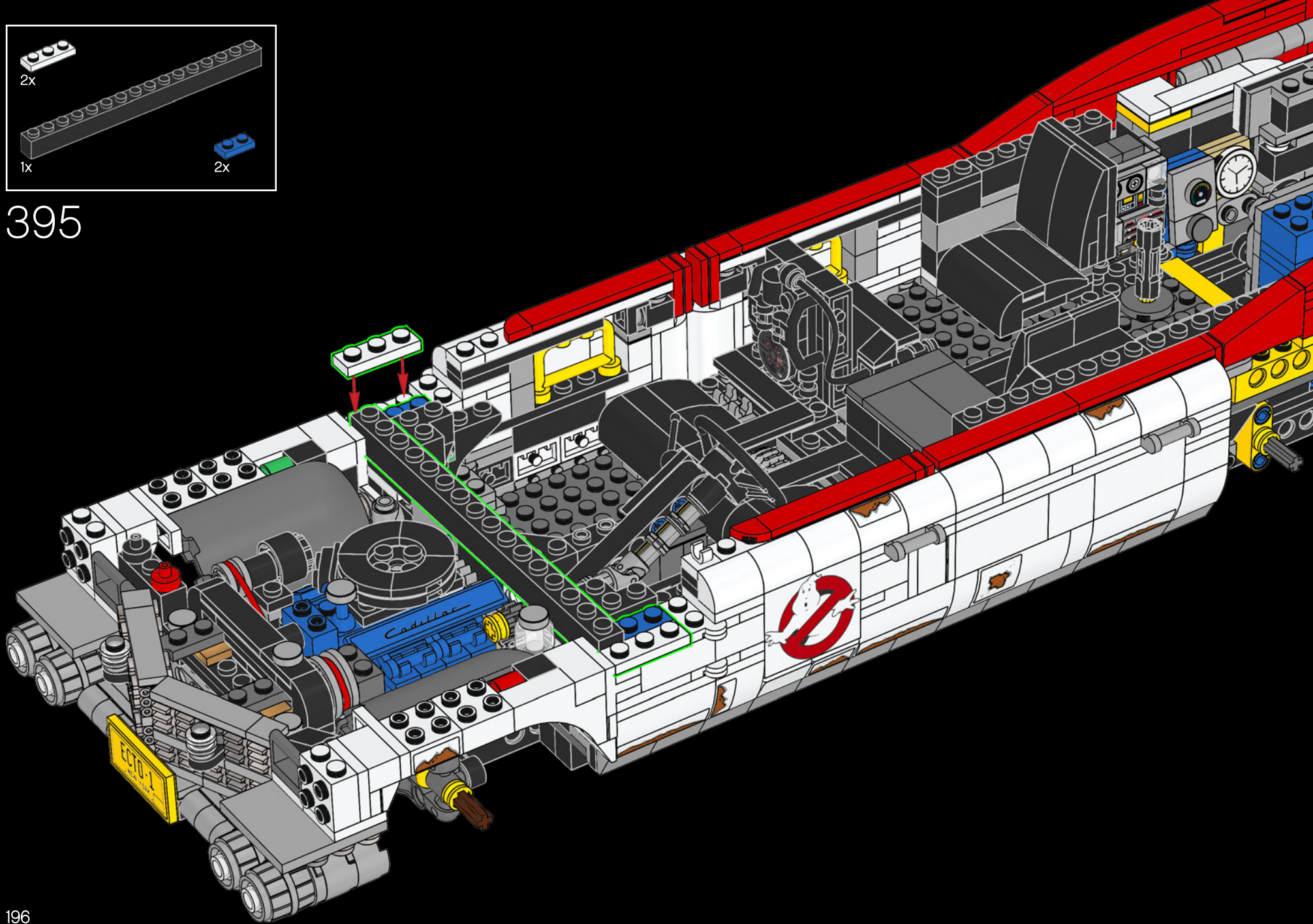

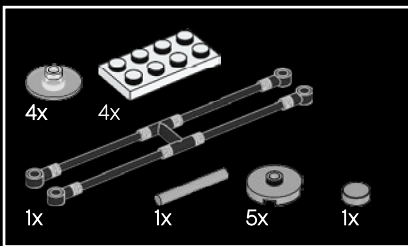

396

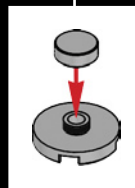
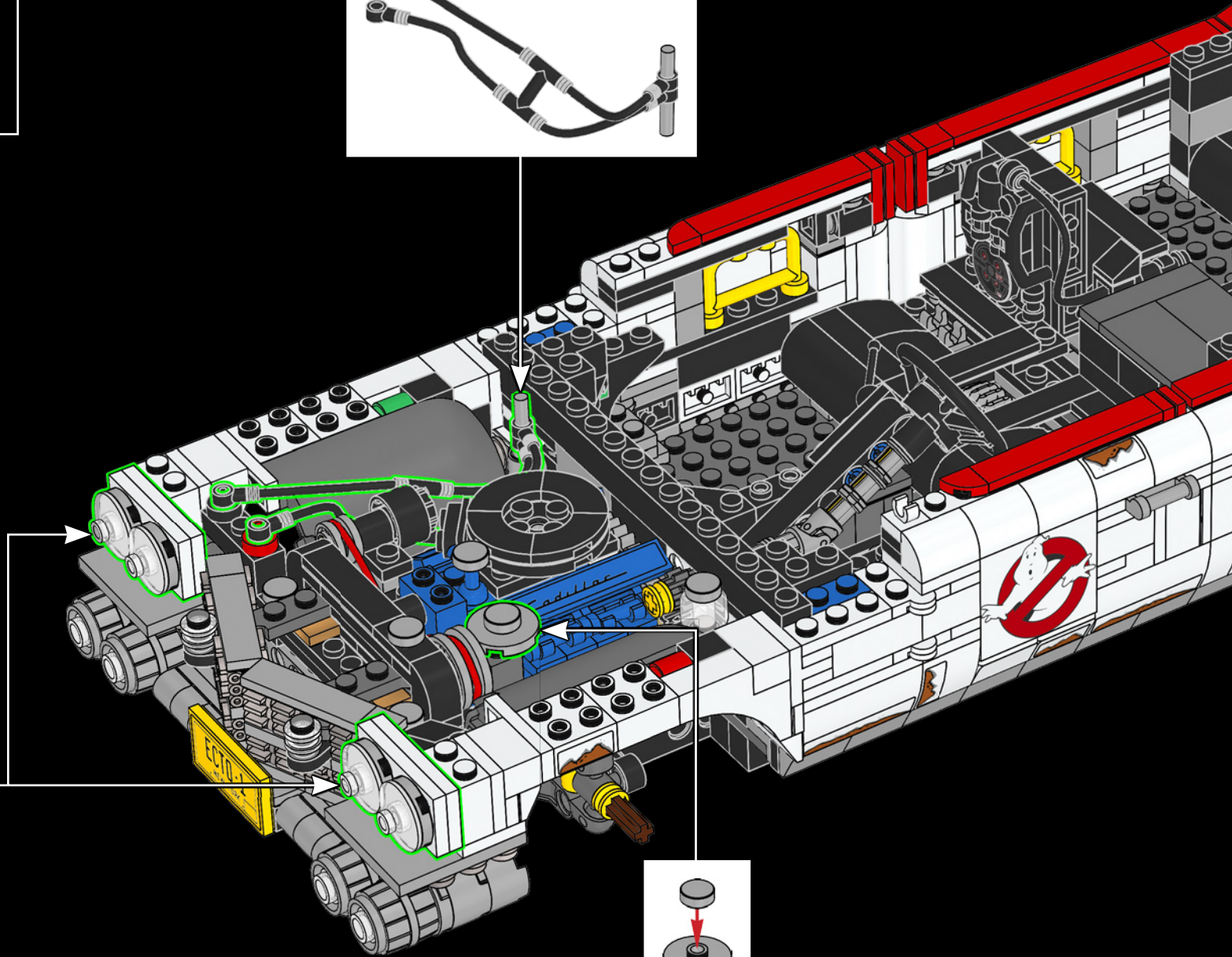
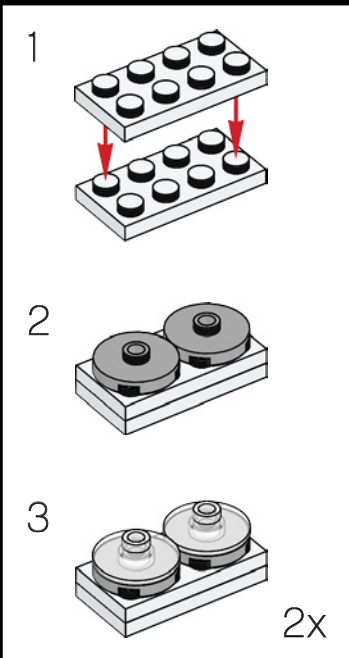

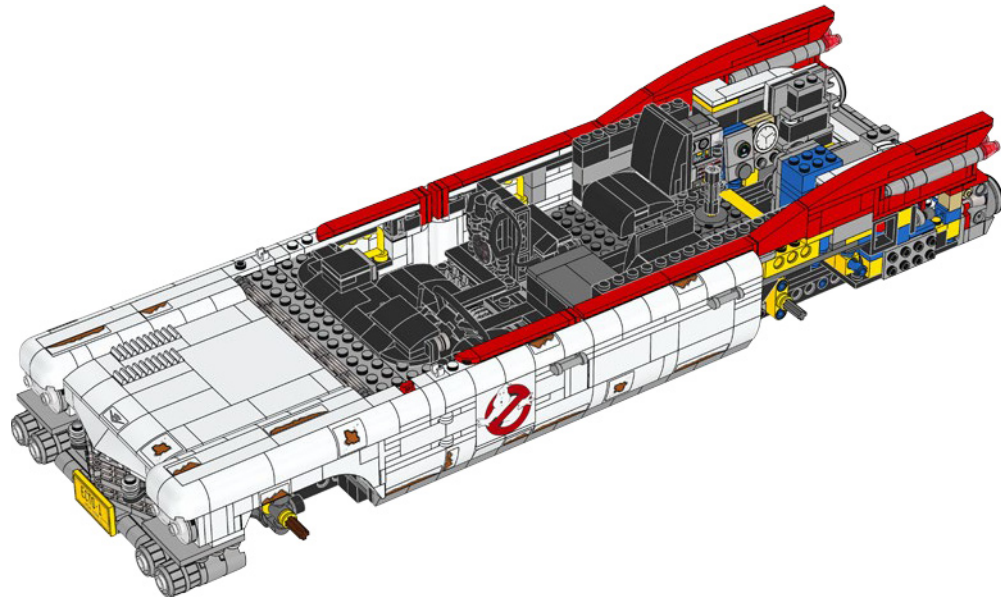
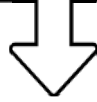

4x

397

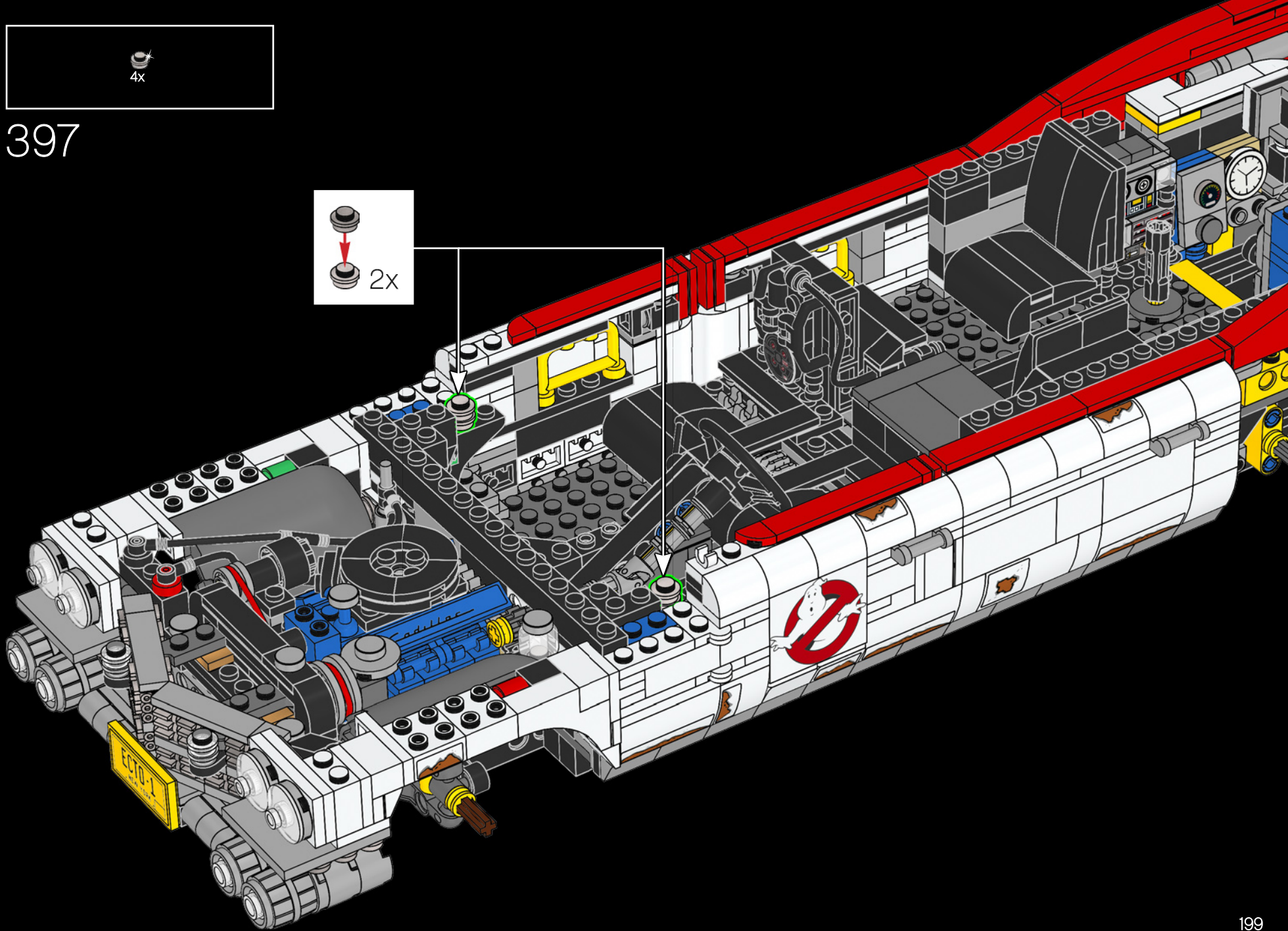
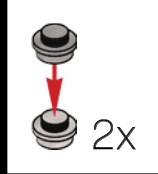

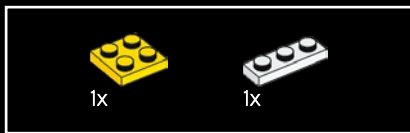

398

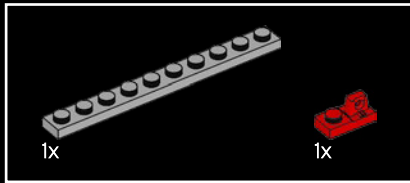
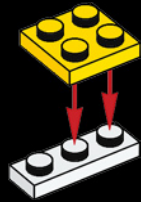

399

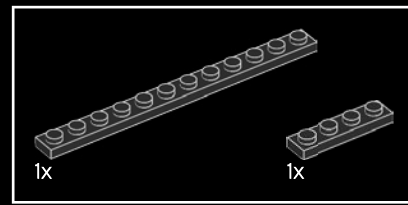
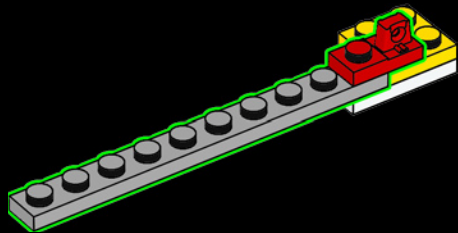

400

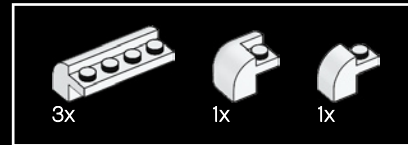
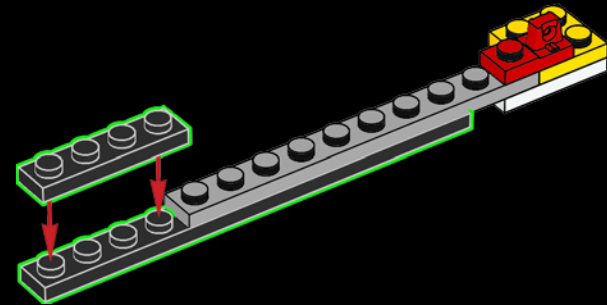

401

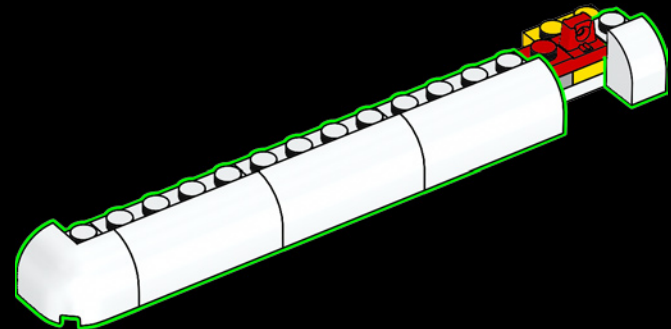



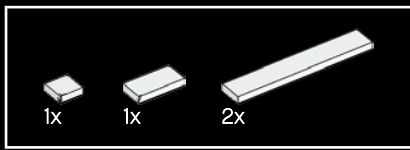

402

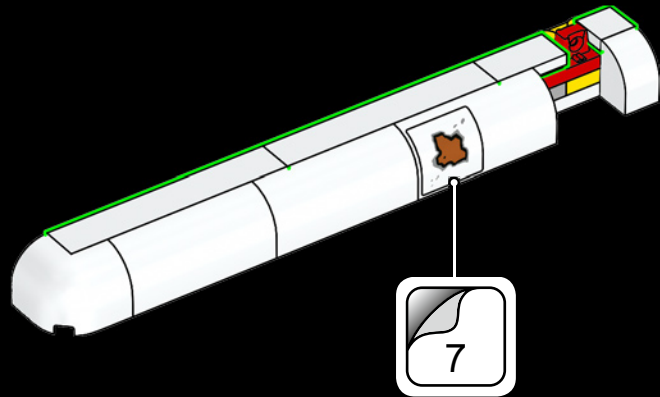

403

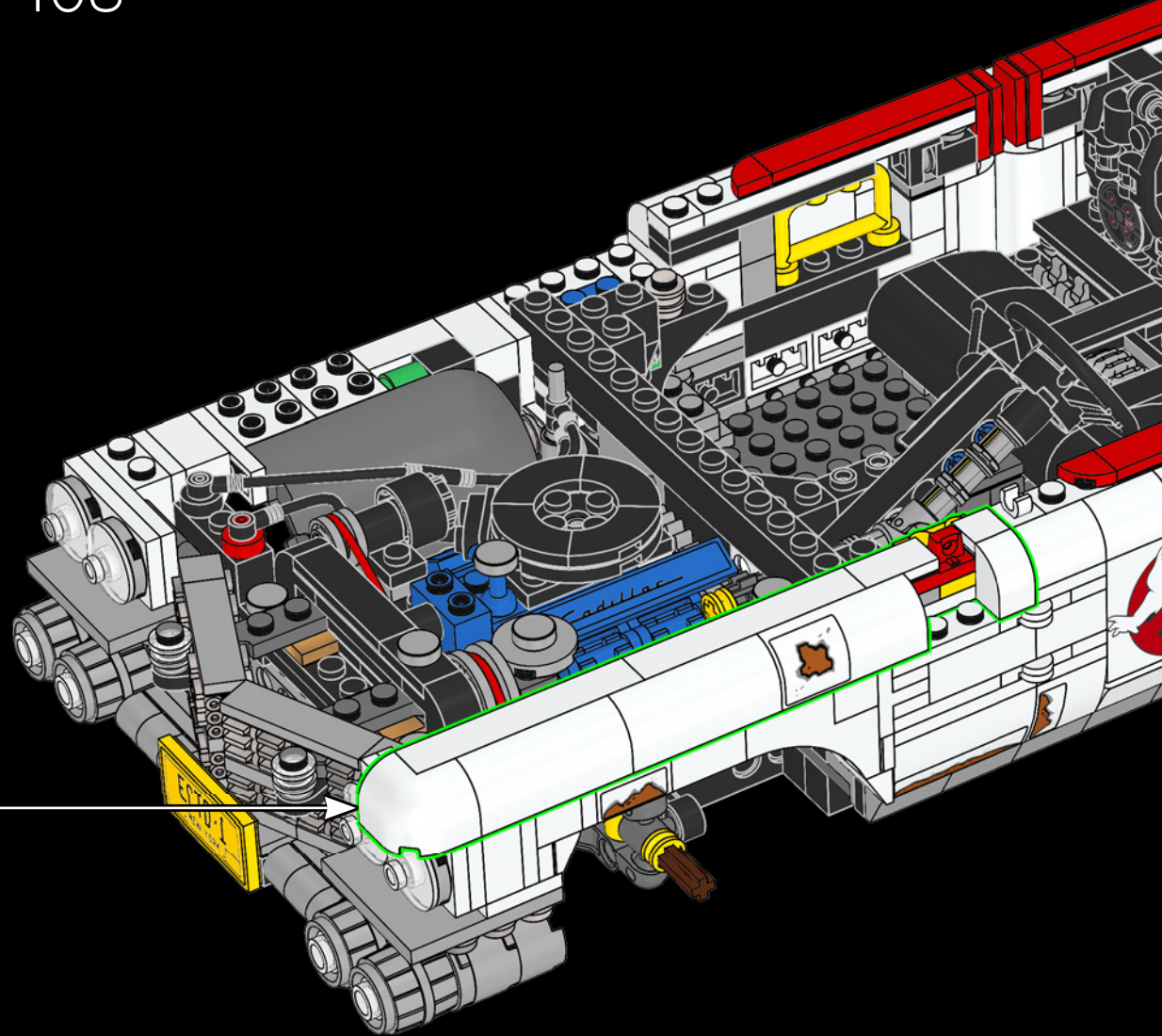

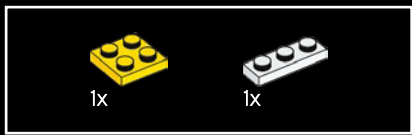

404

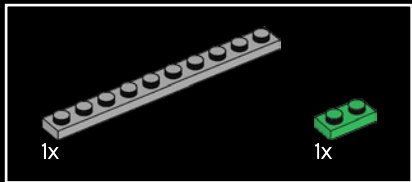
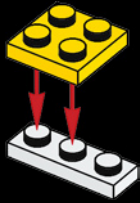

405

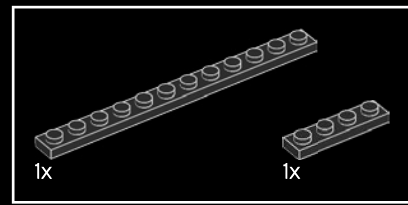
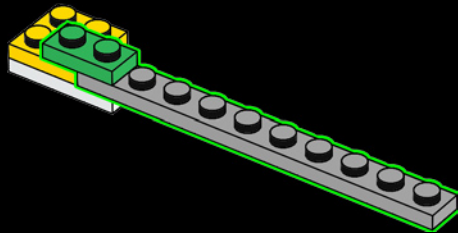

406

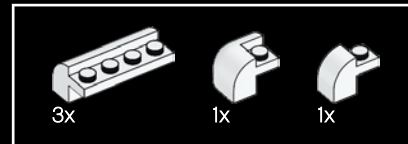
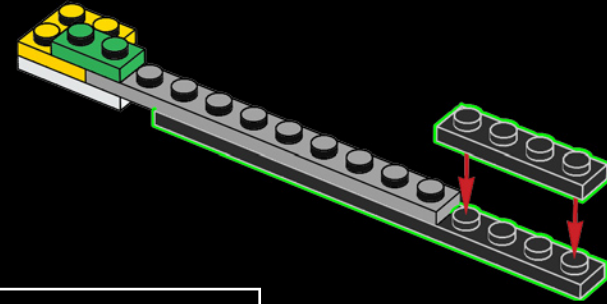

407

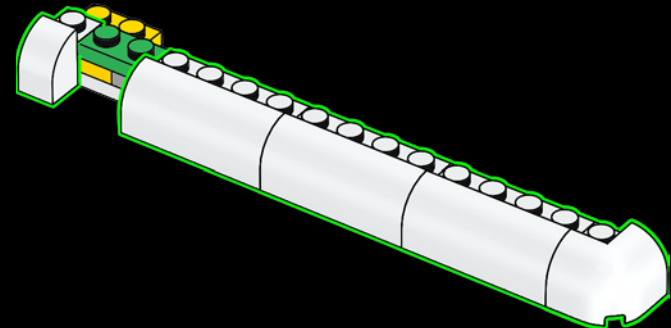

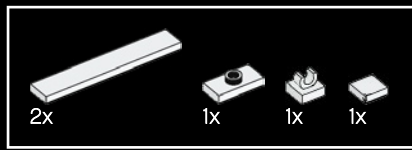

408

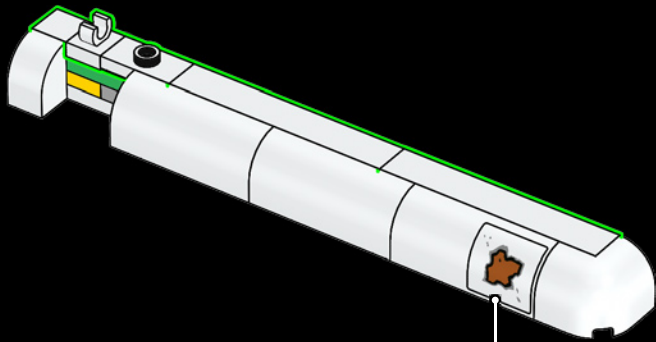

409

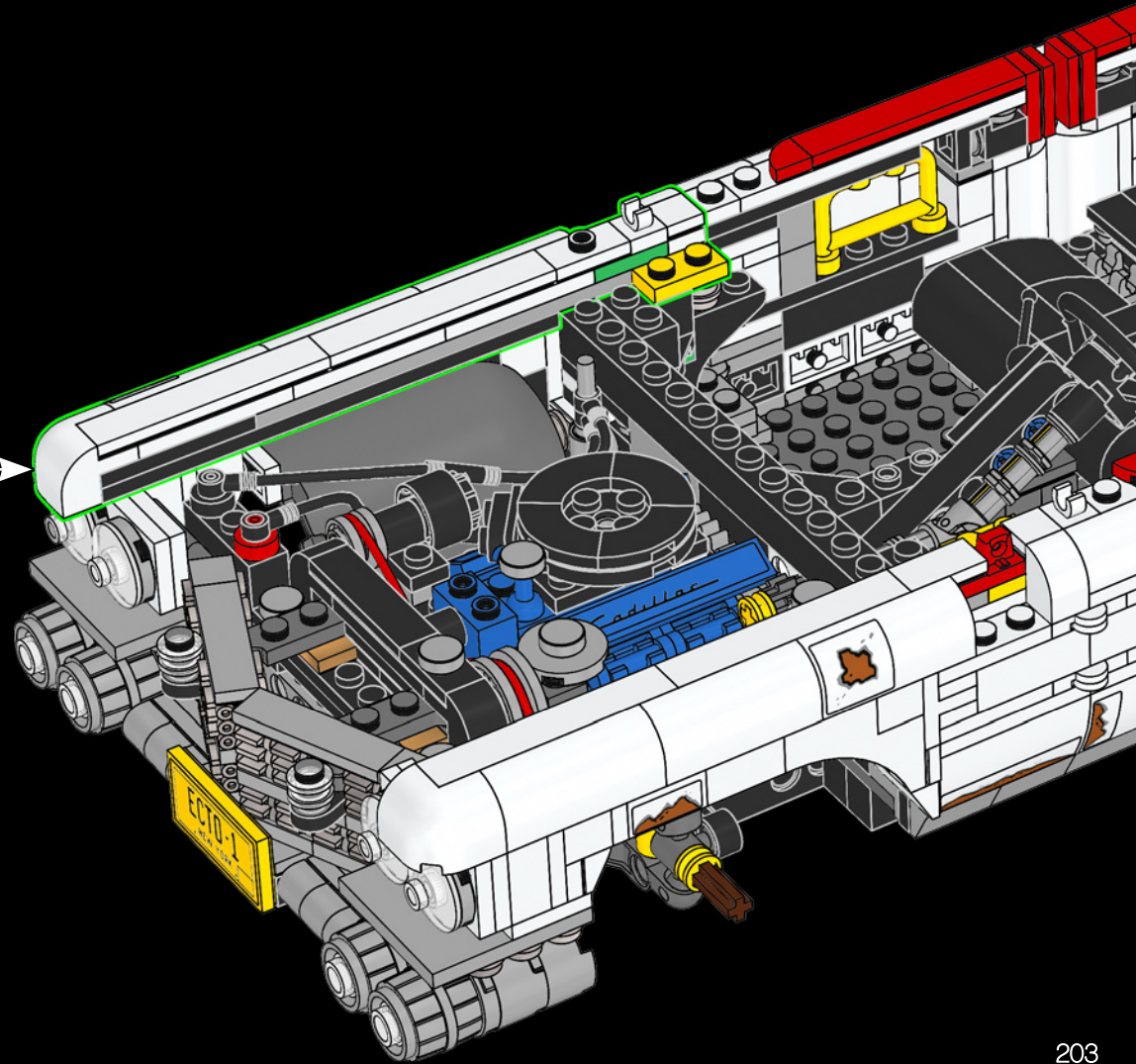

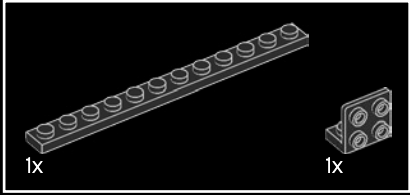
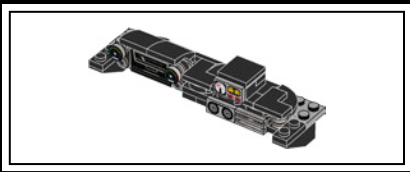

410

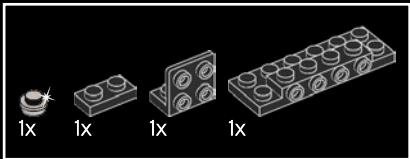
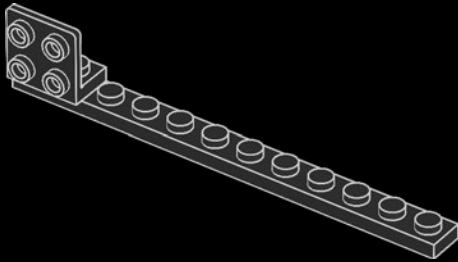

411

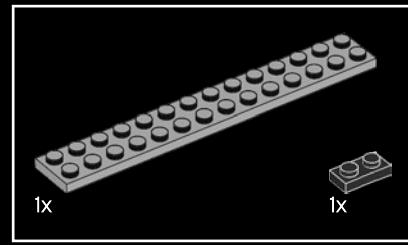
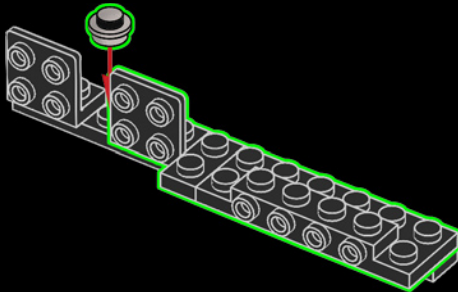

412

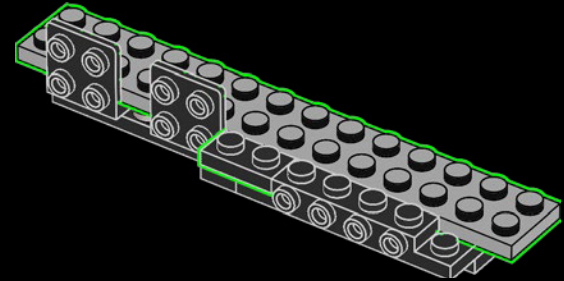

413

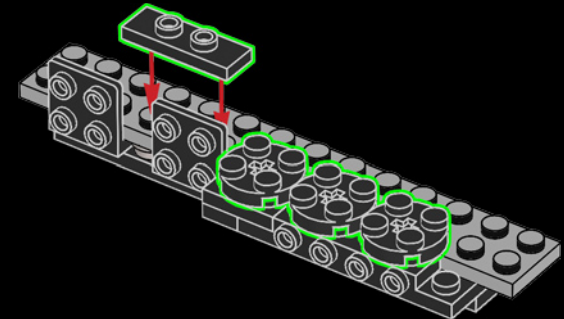

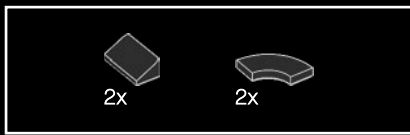

414

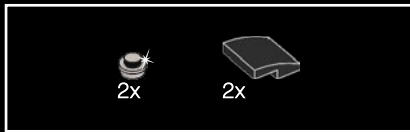
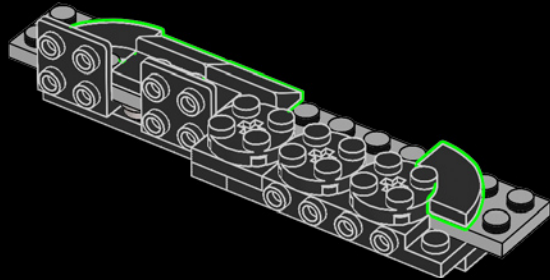

415

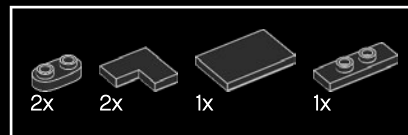
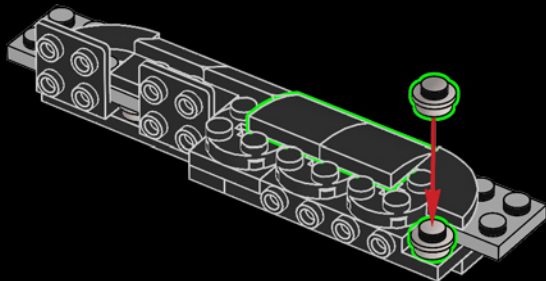

416

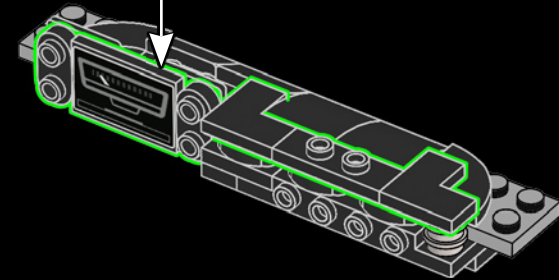
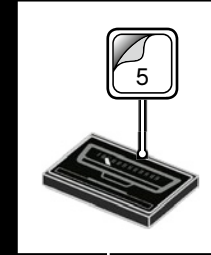

417

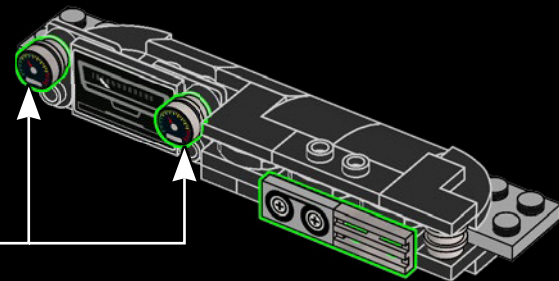
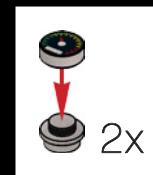

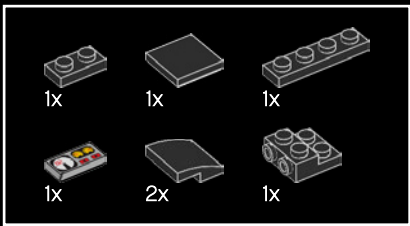

418

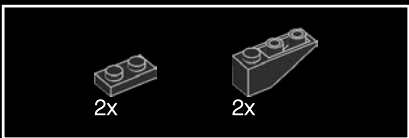
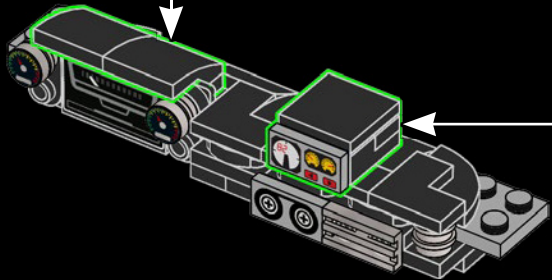
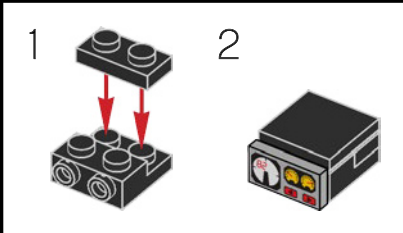
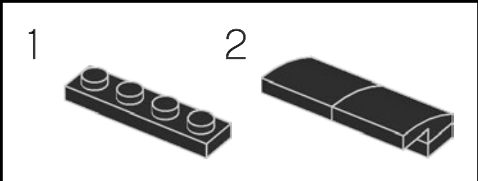

419

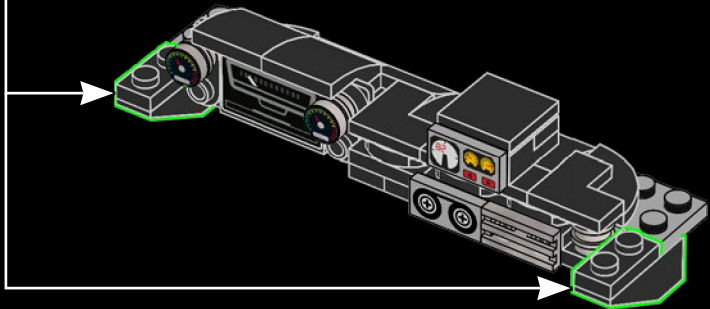
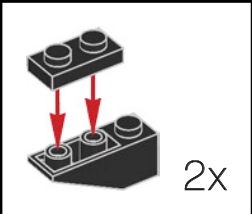

420

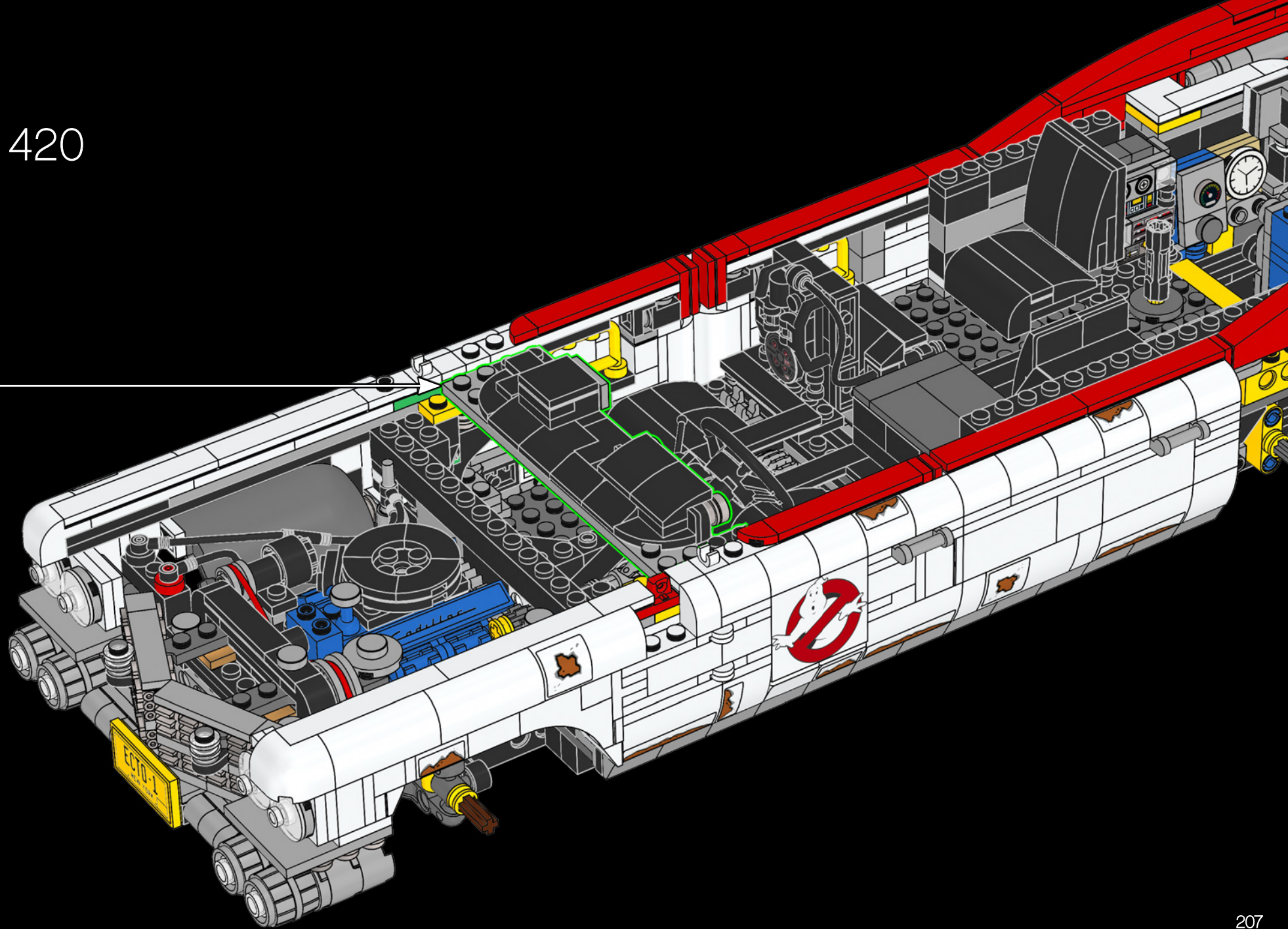

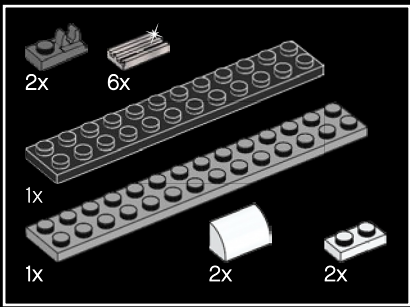

421

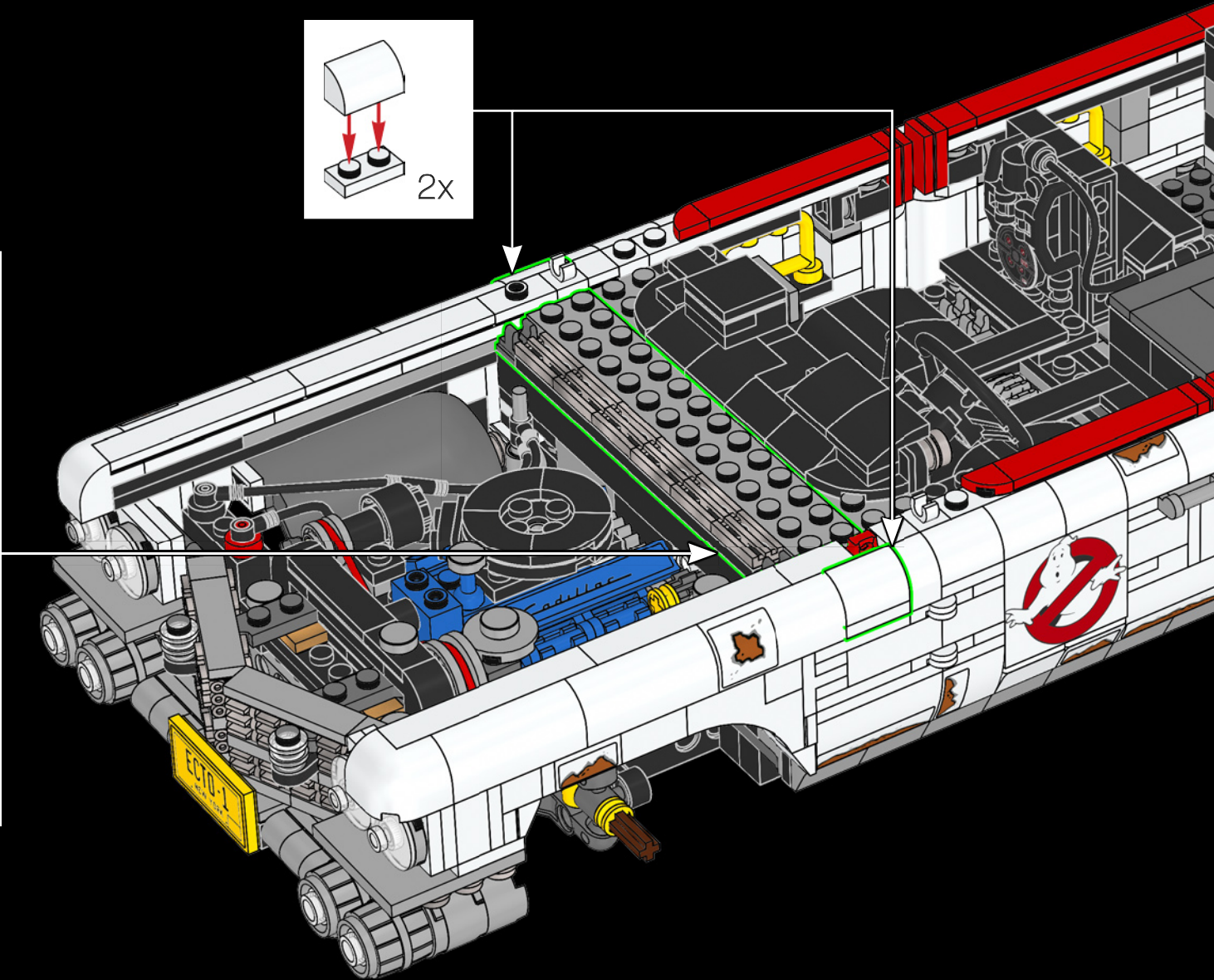
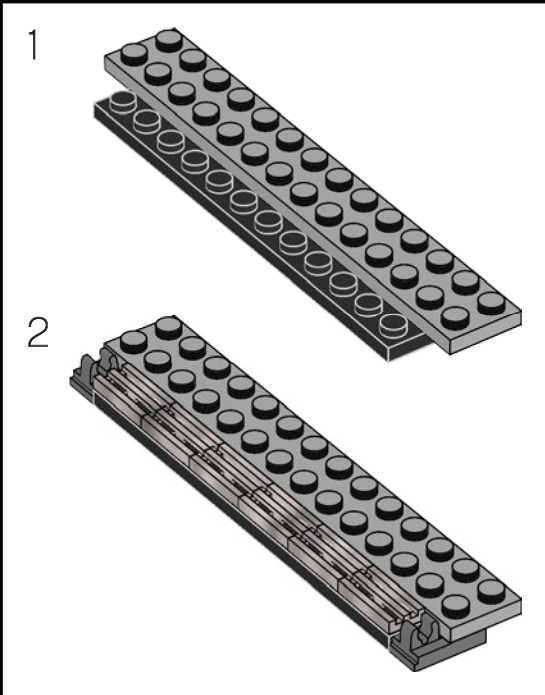
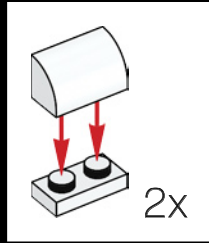



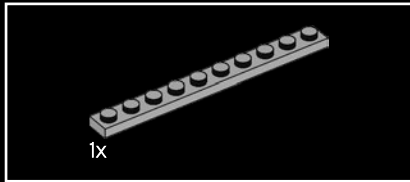
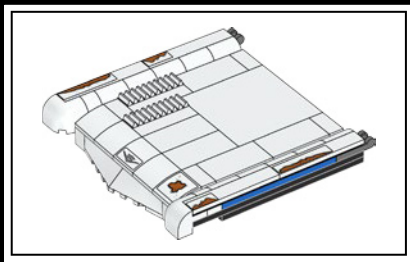

422

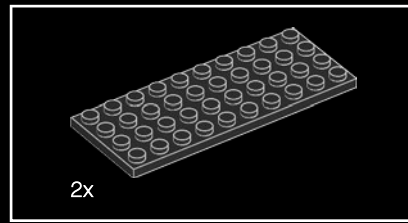
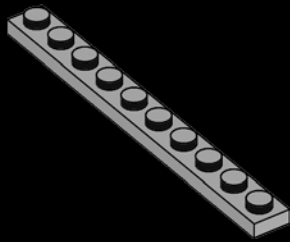

2x

423

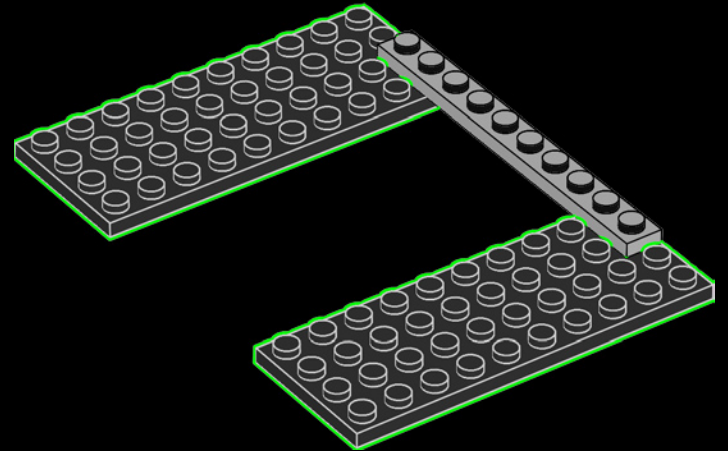

4x

424

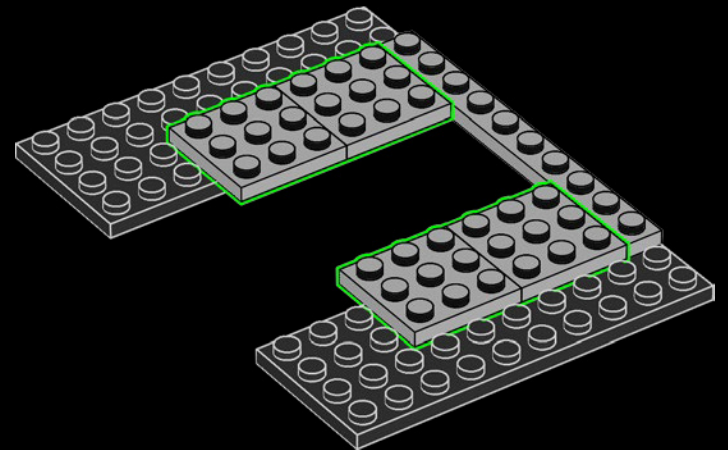

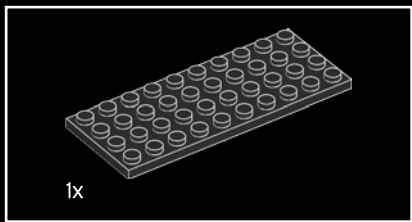

425

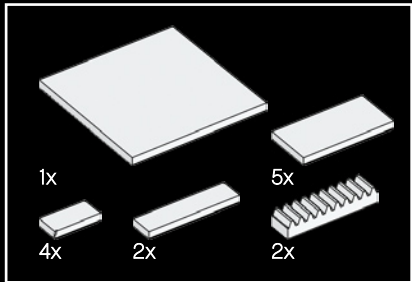
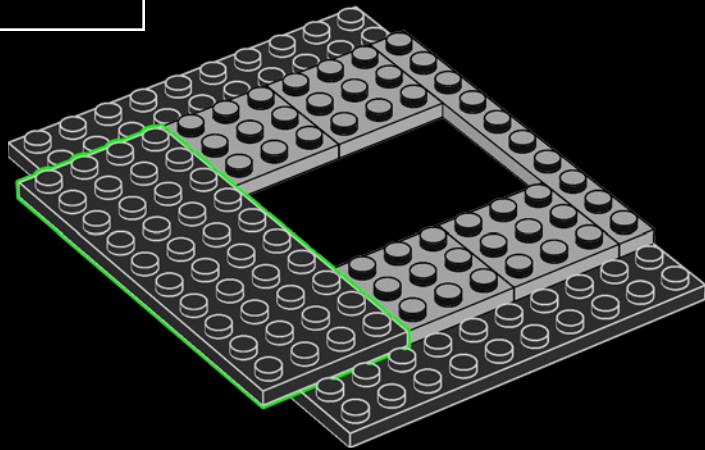

426

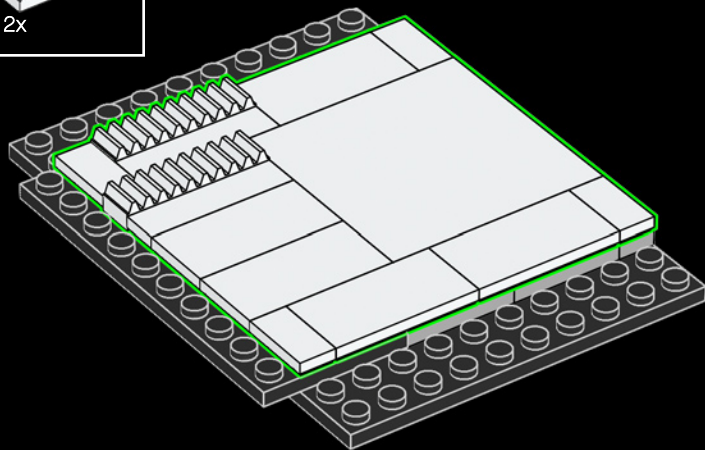

427

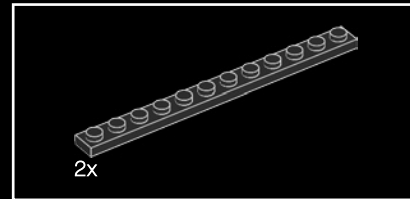
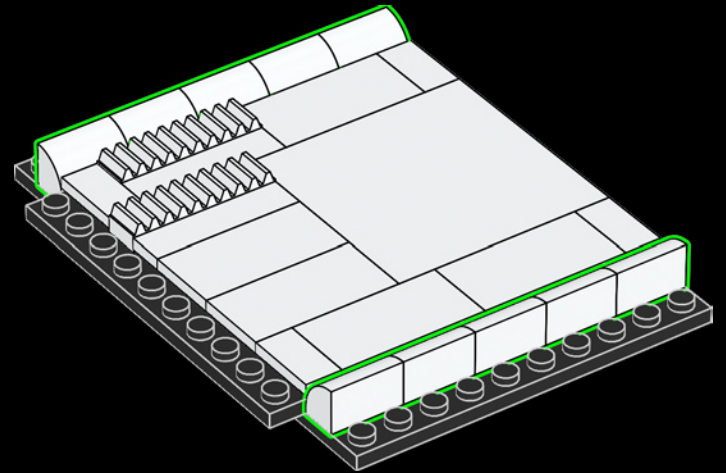

428

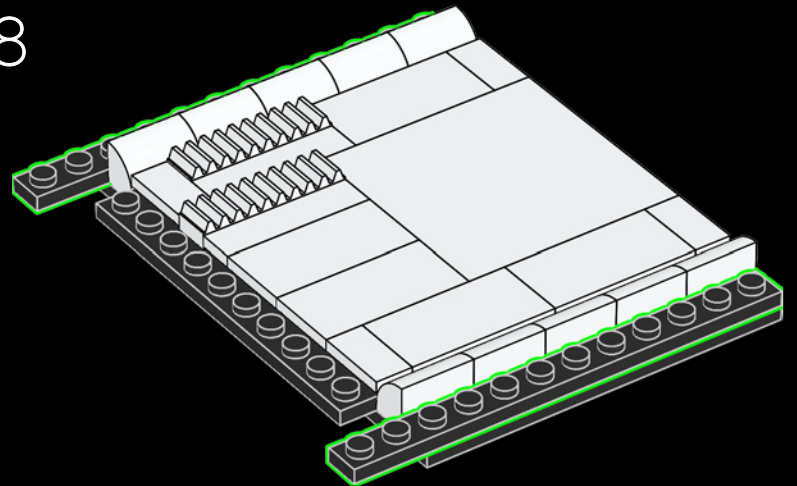

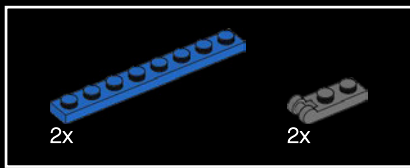

429

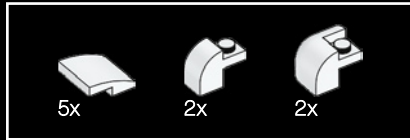
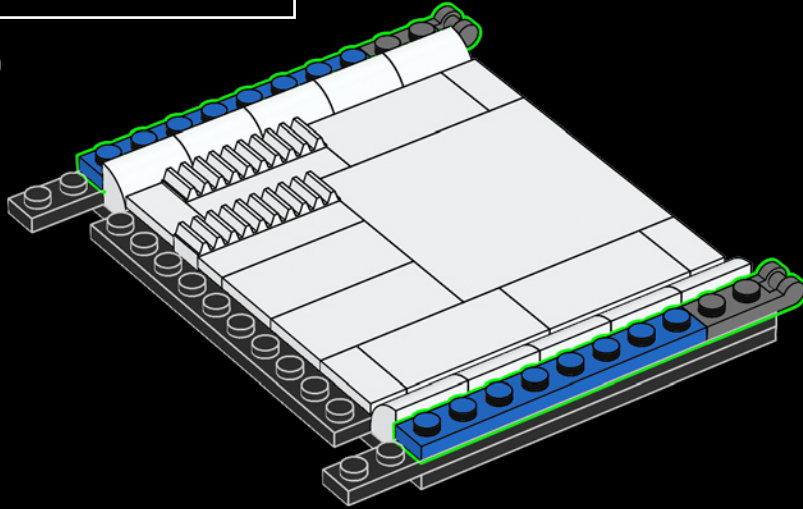

430

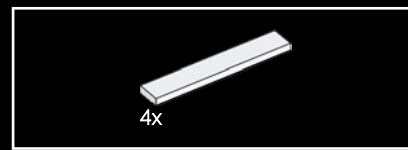
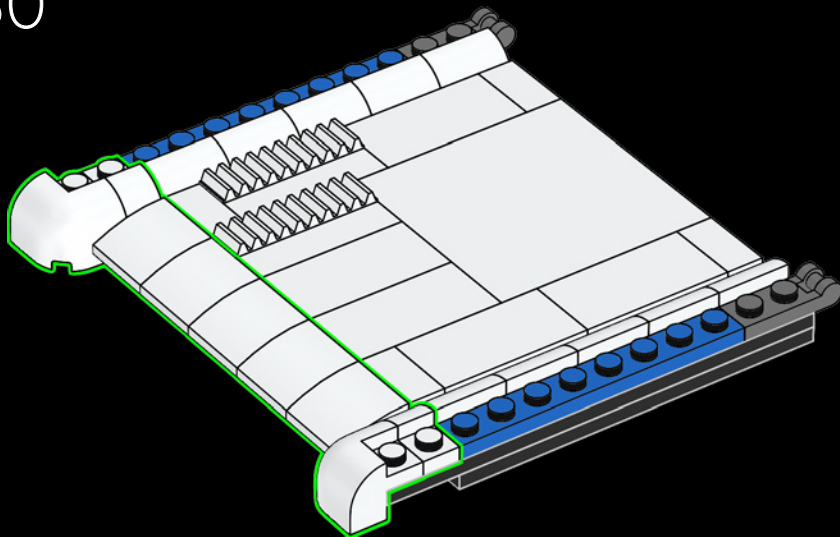

431

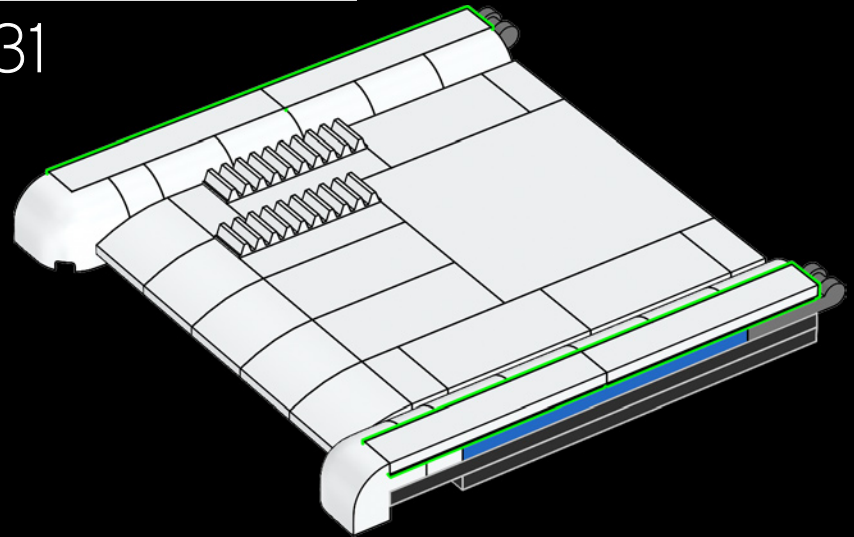

432

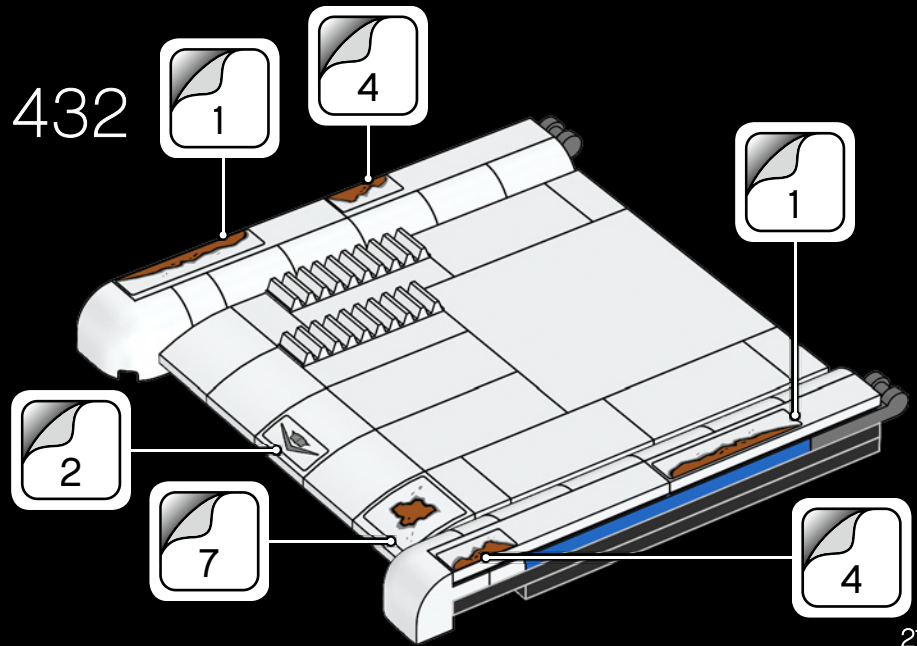

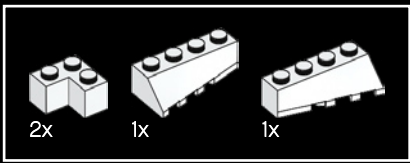

433

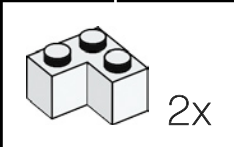
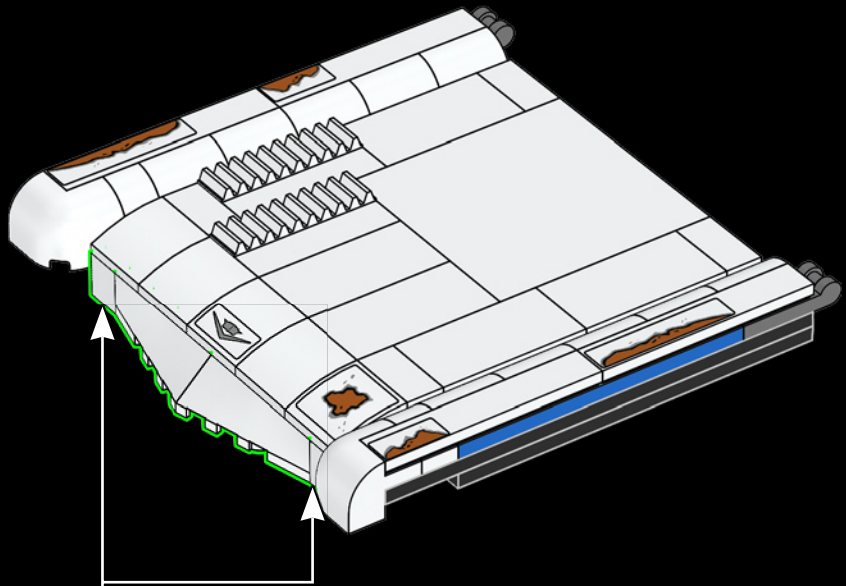

434

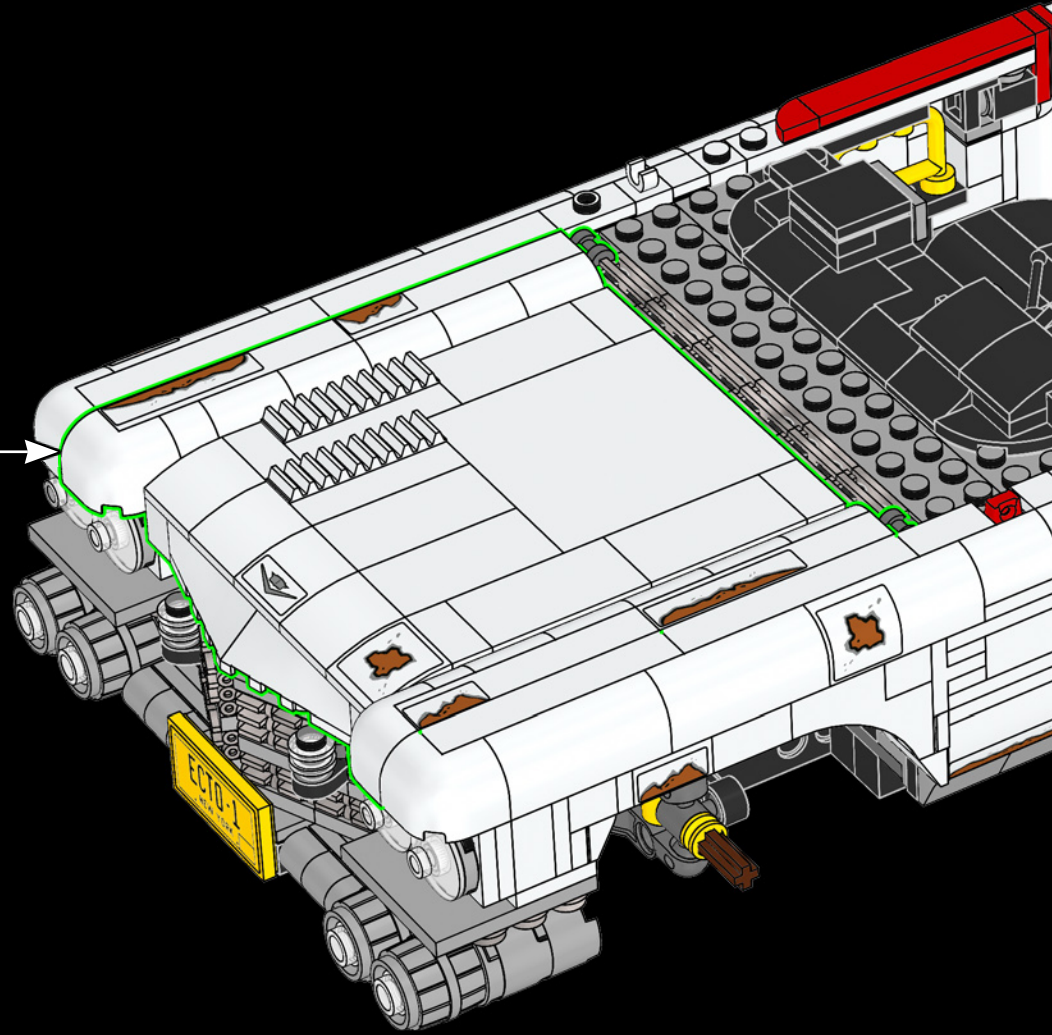

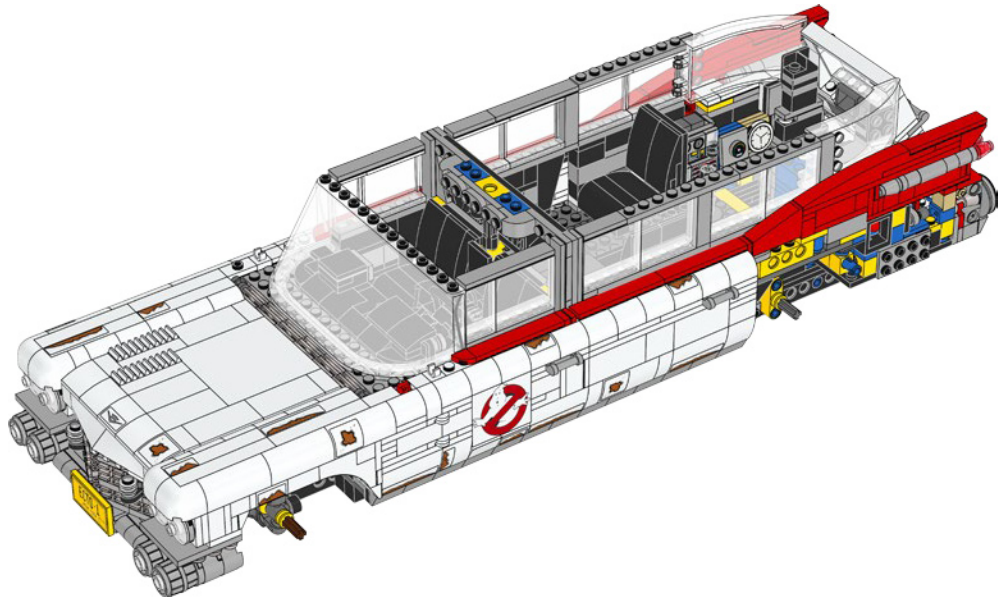
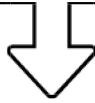
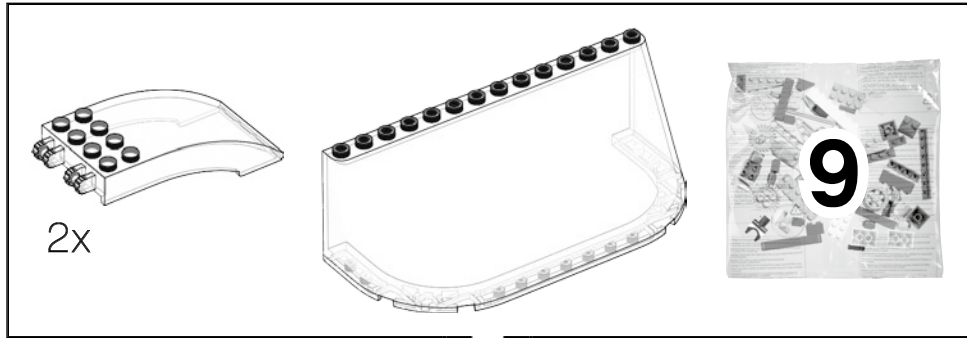

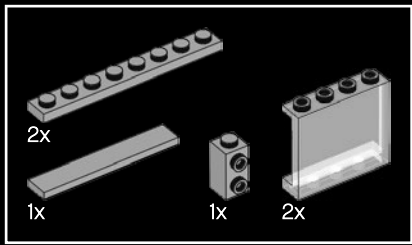

435

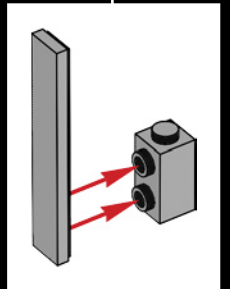
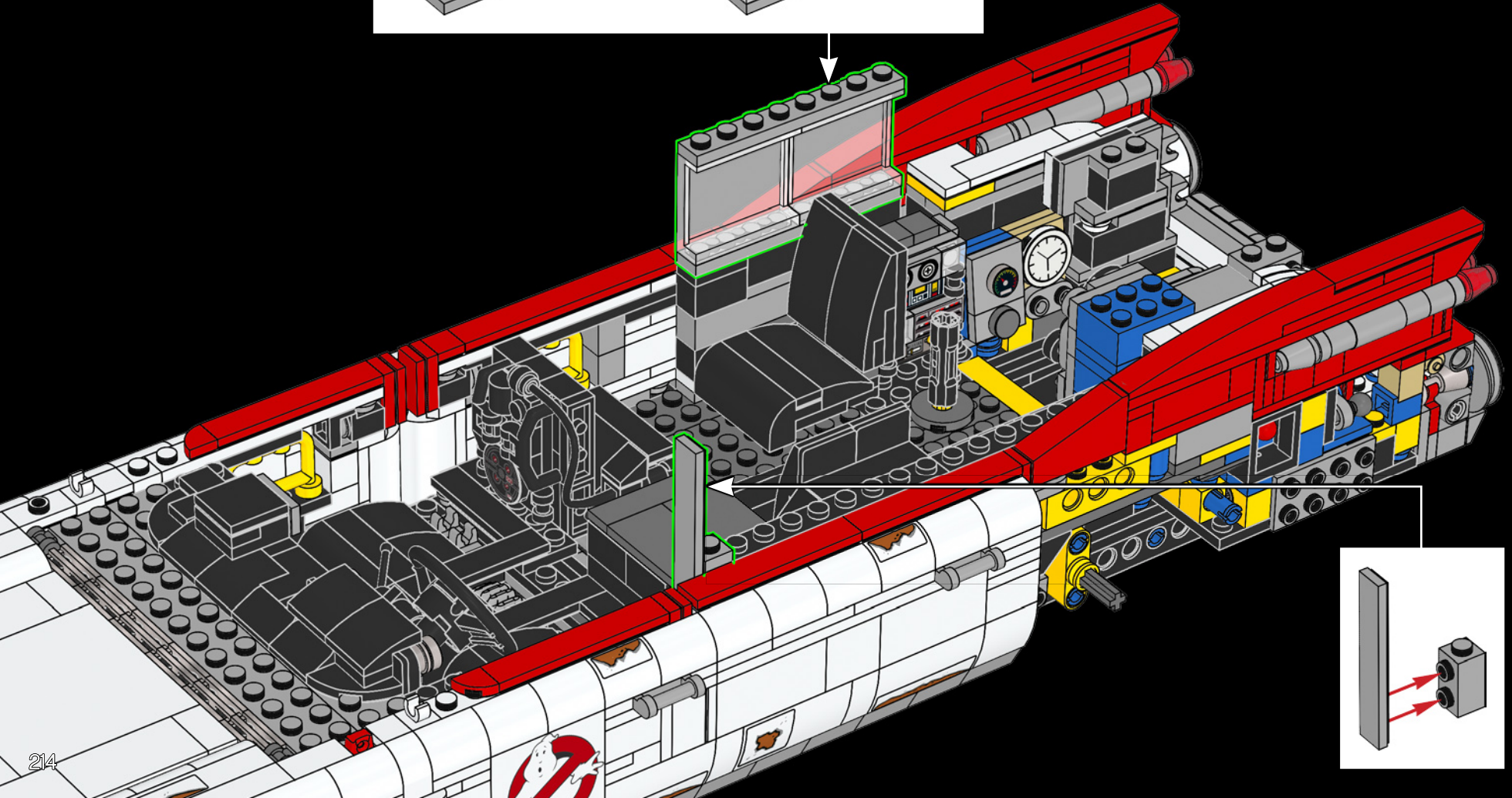
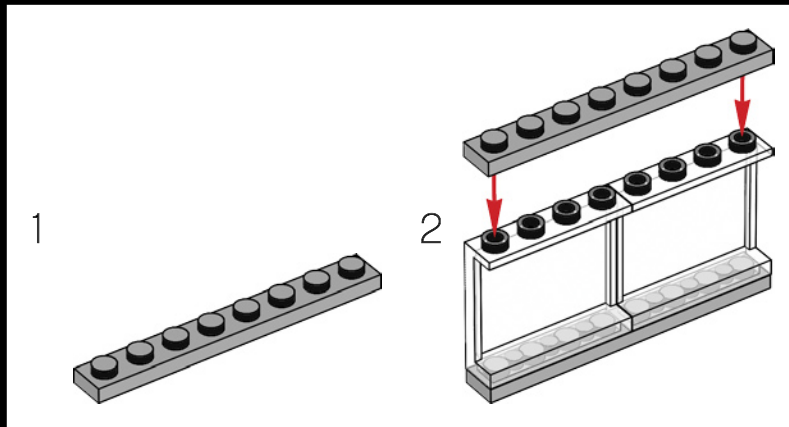

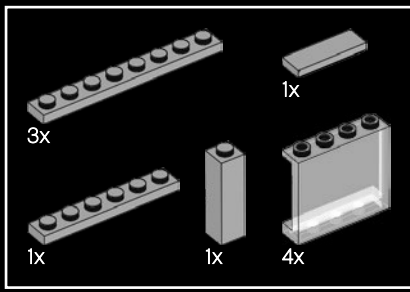

436

1

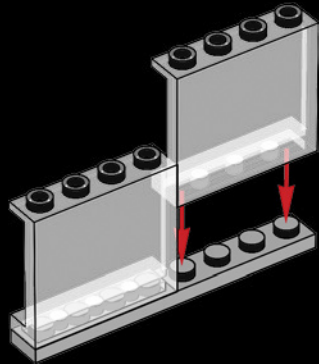

2

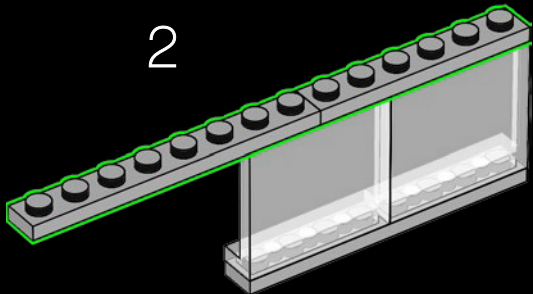

3

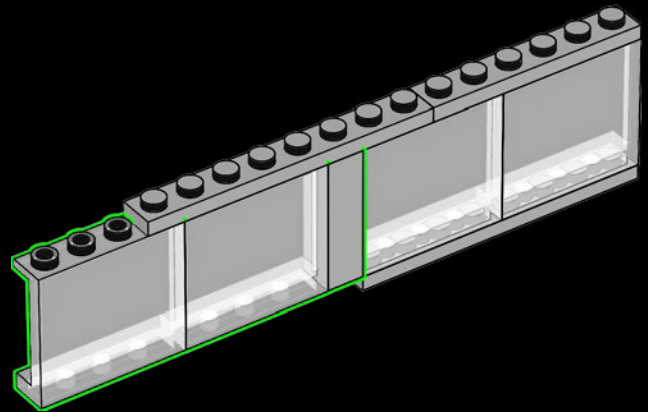

4

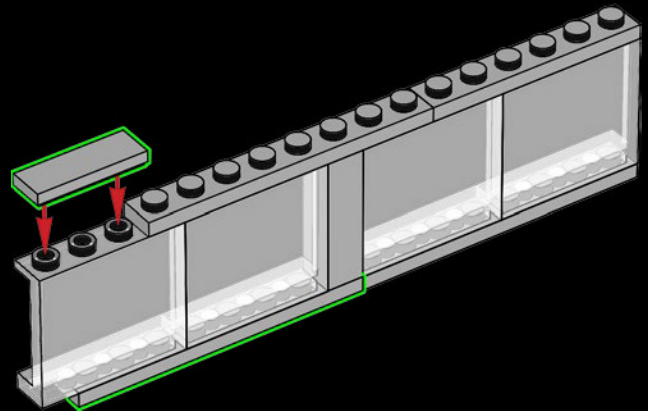

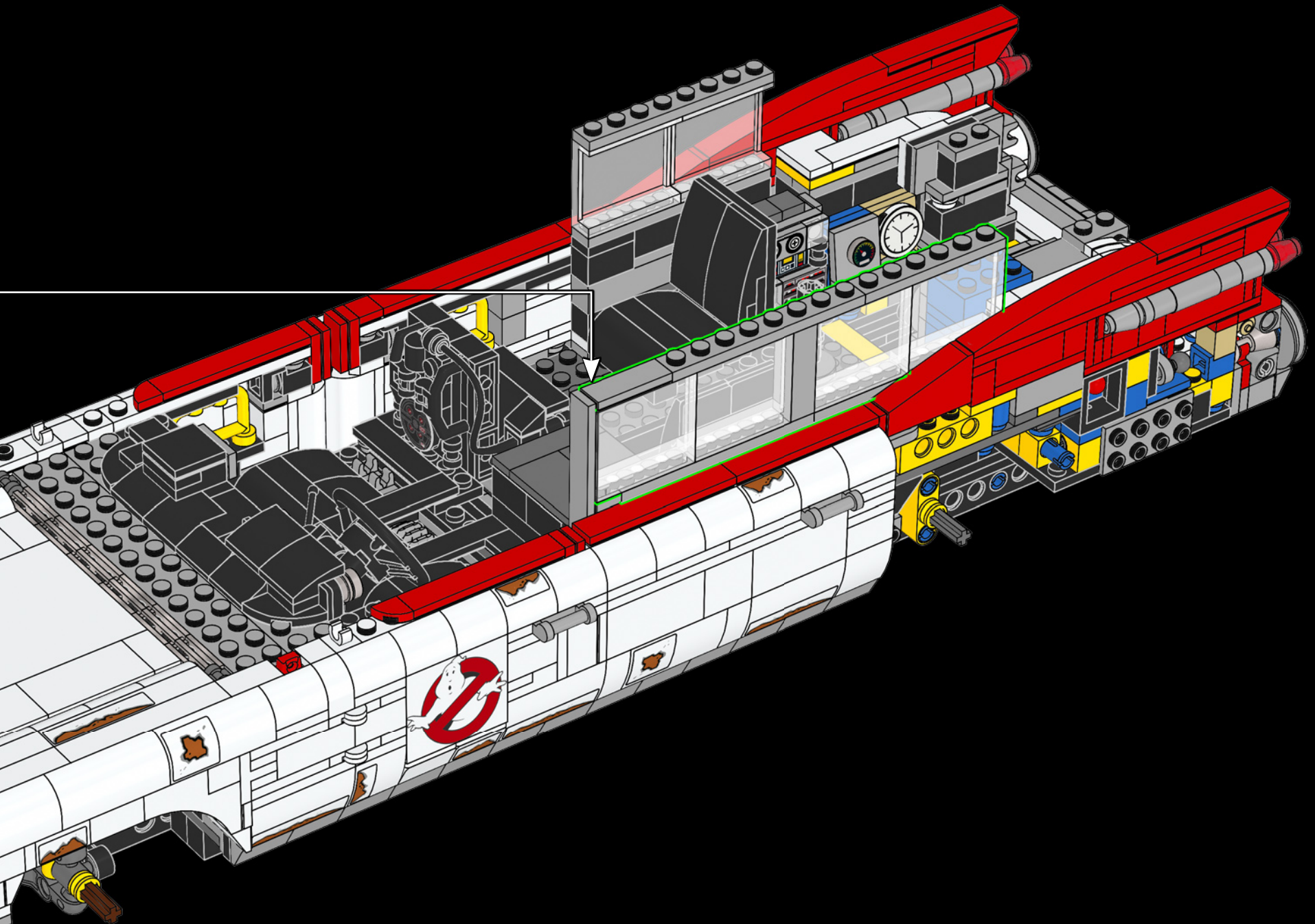



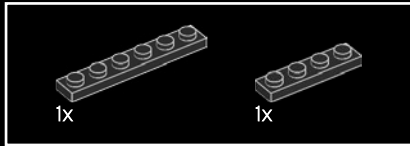
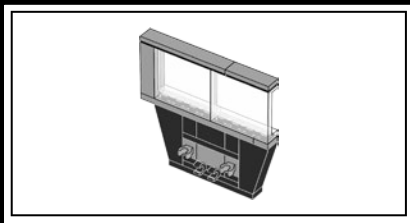

437

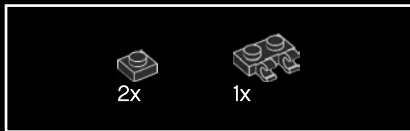
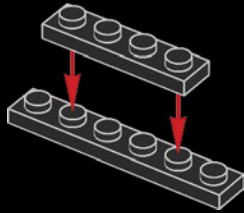

438

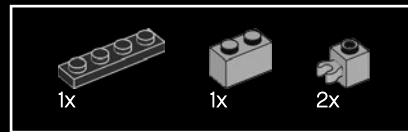
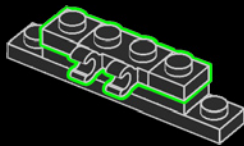

439

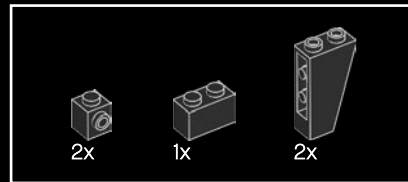
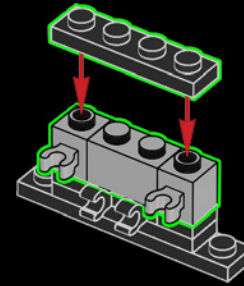

440

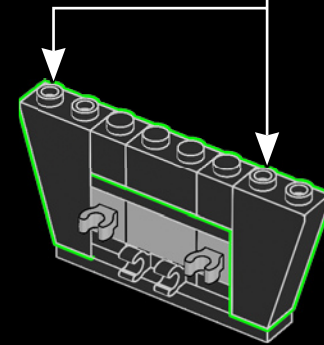
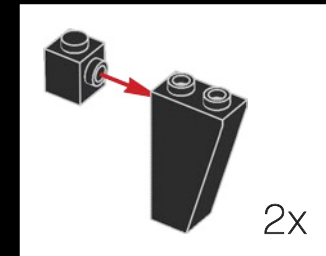

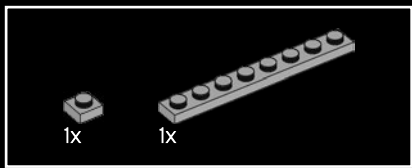

441

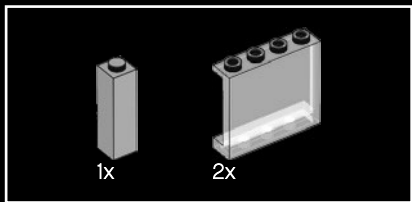
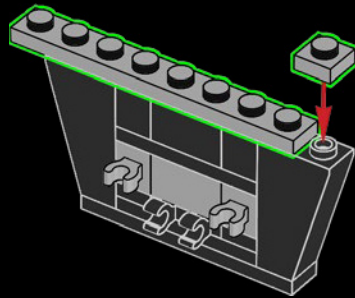

442

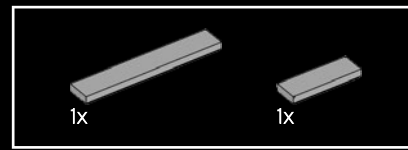
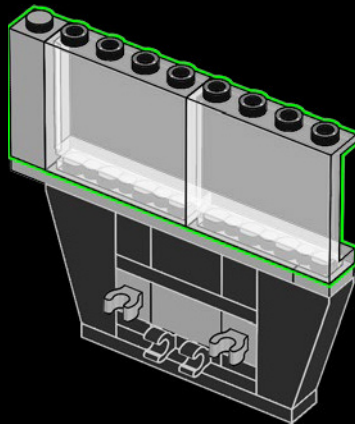

443



444

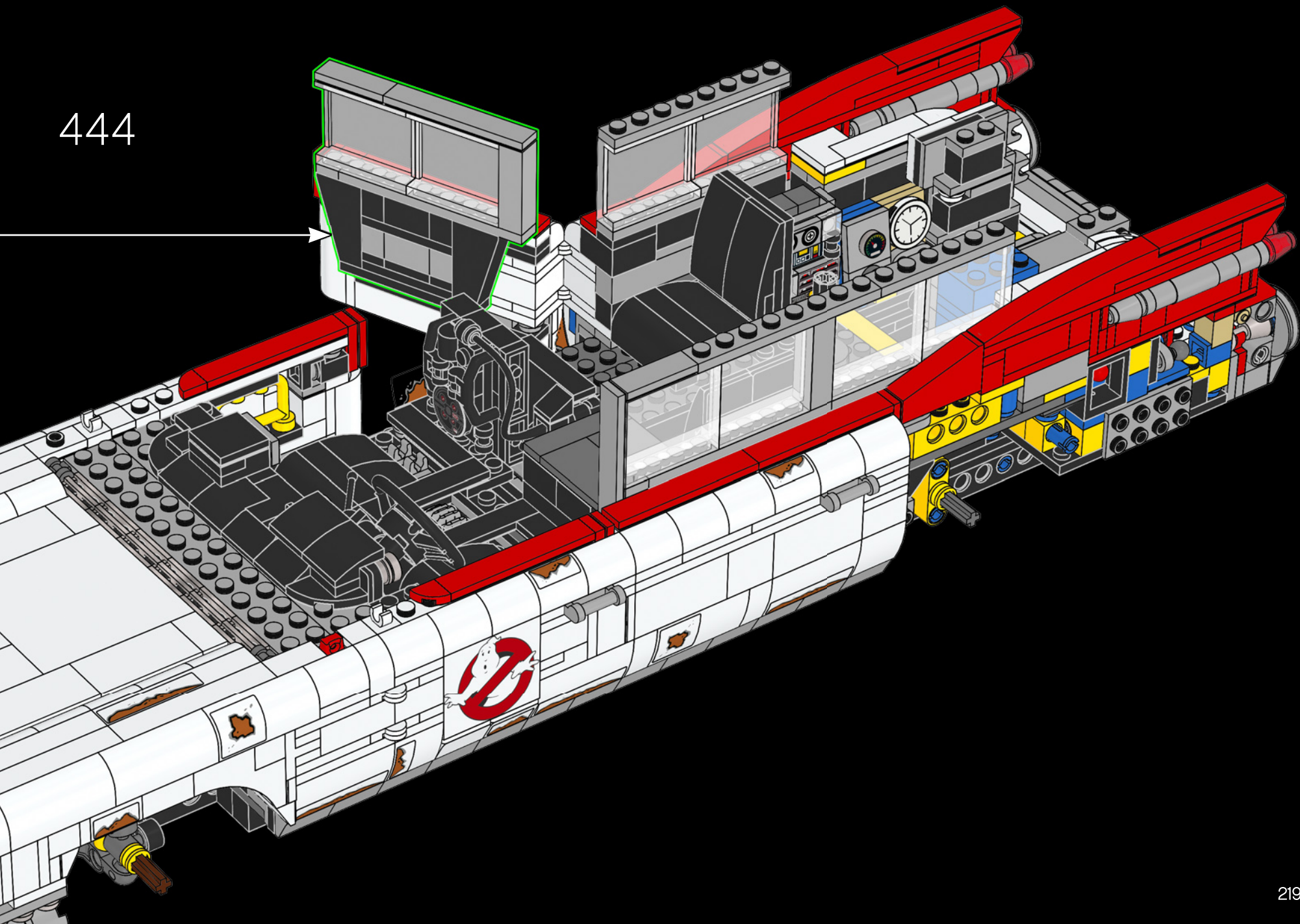

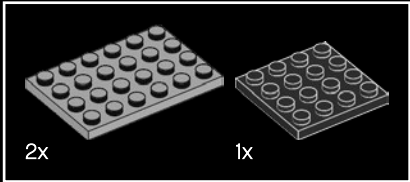
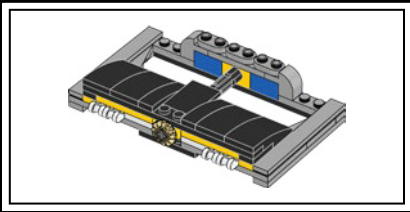

445

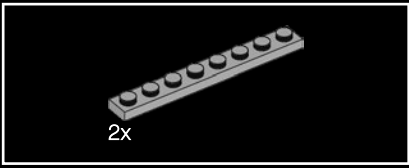
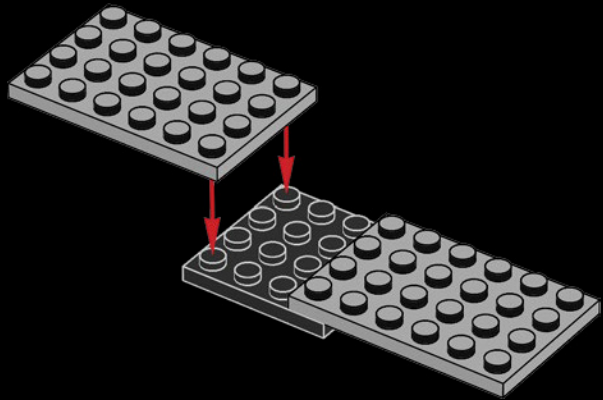

446

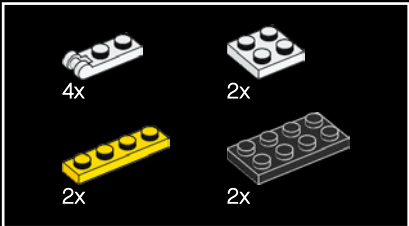
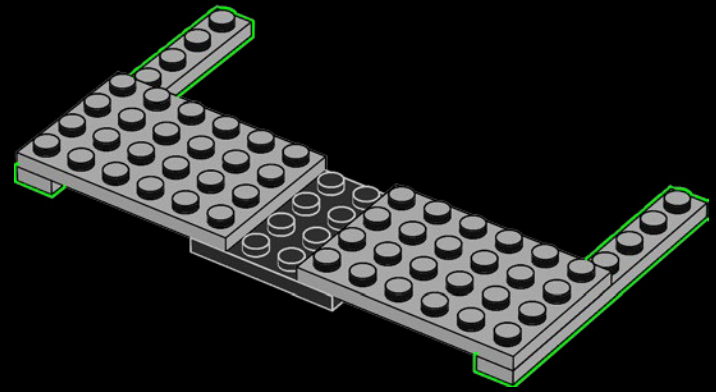

447

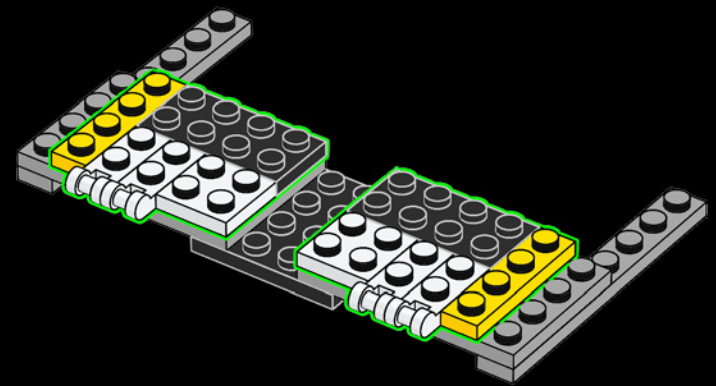

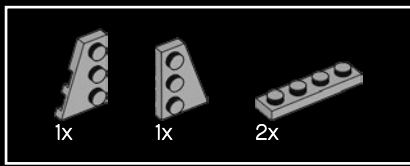

448

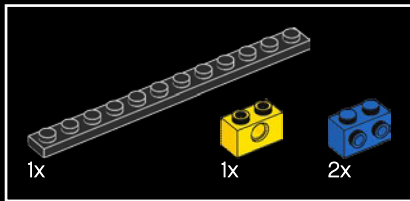
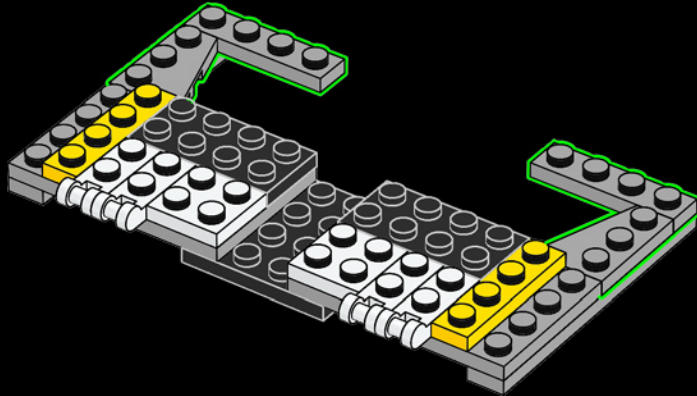

449

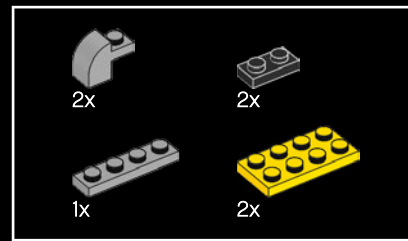
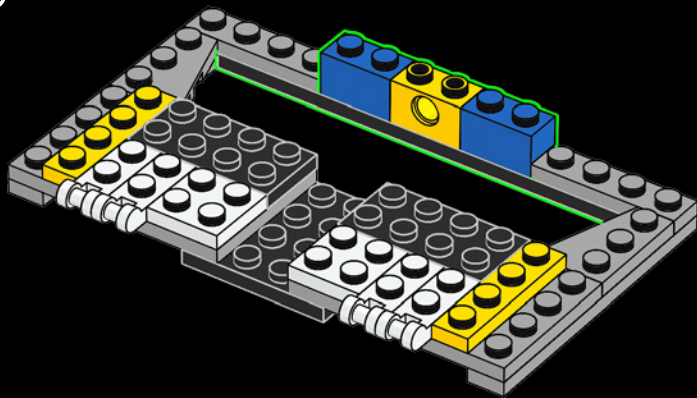

450

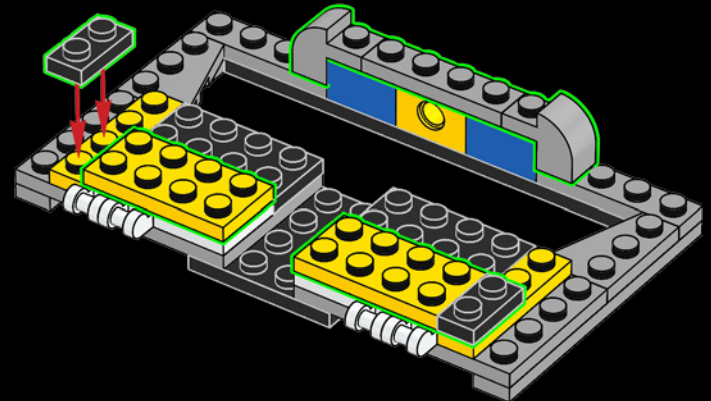

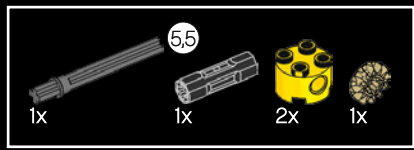

451

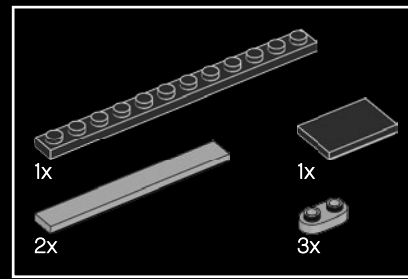
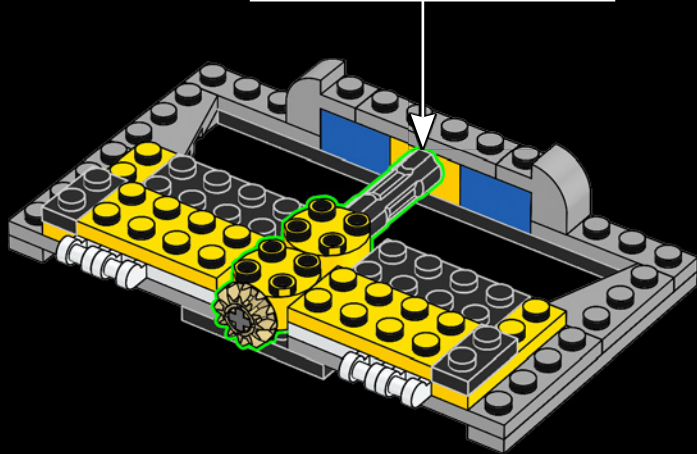
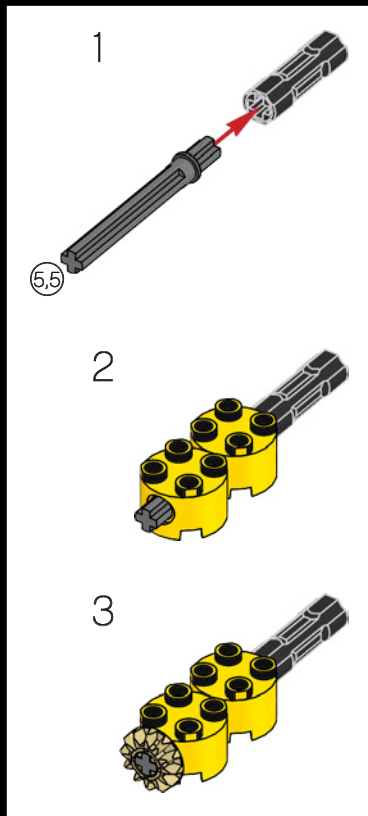

452

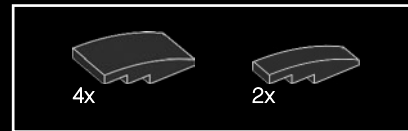
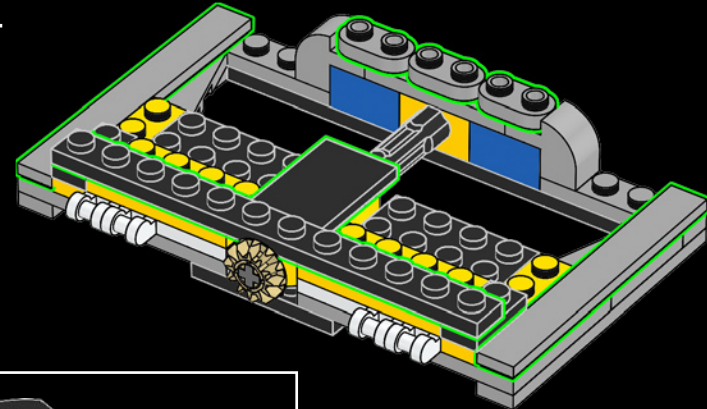

453

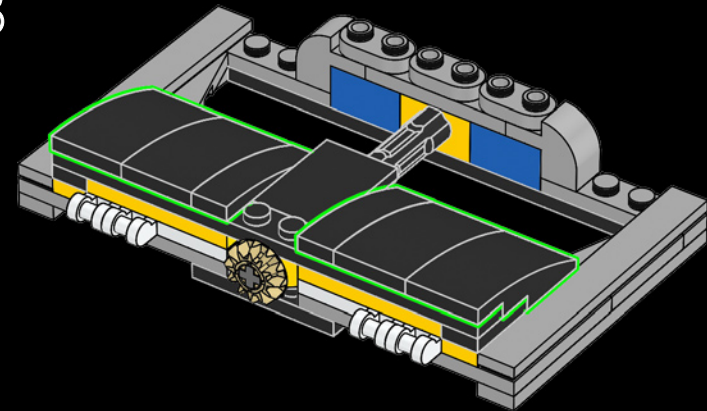

454

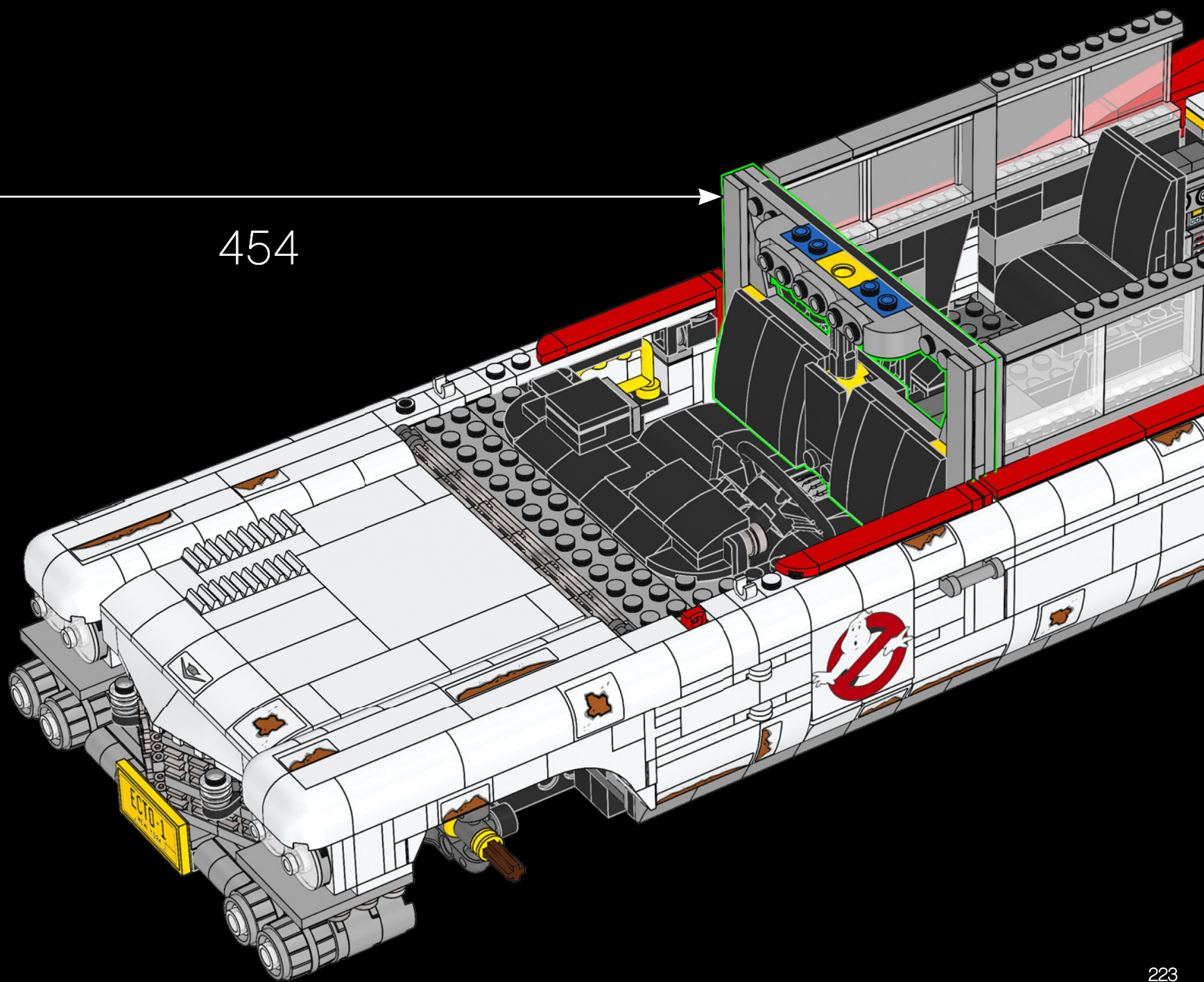

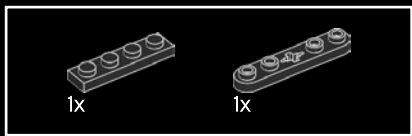

455

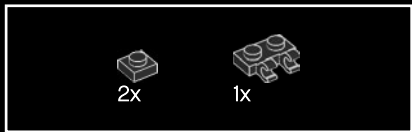
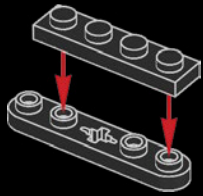

456

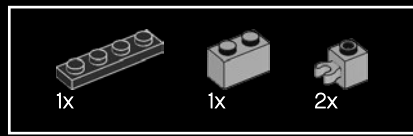
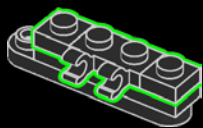

457

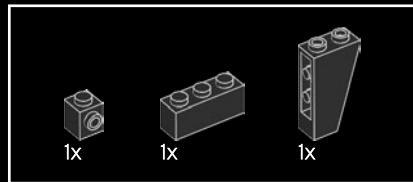
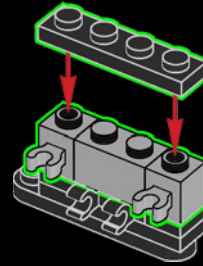

458

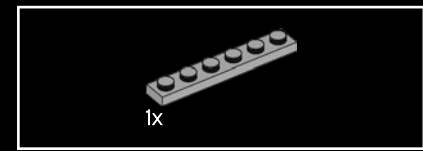
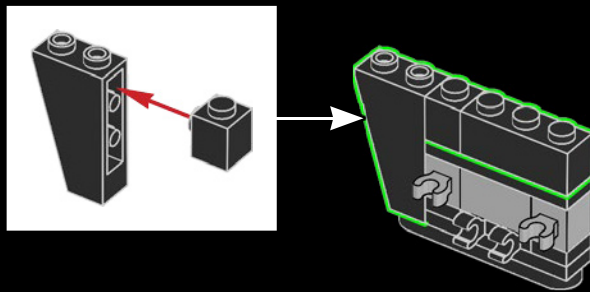

459

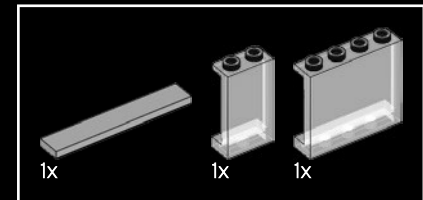
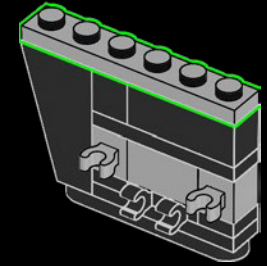

460

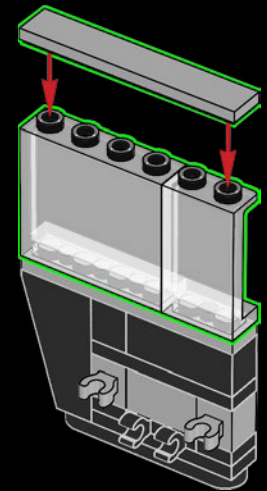



461

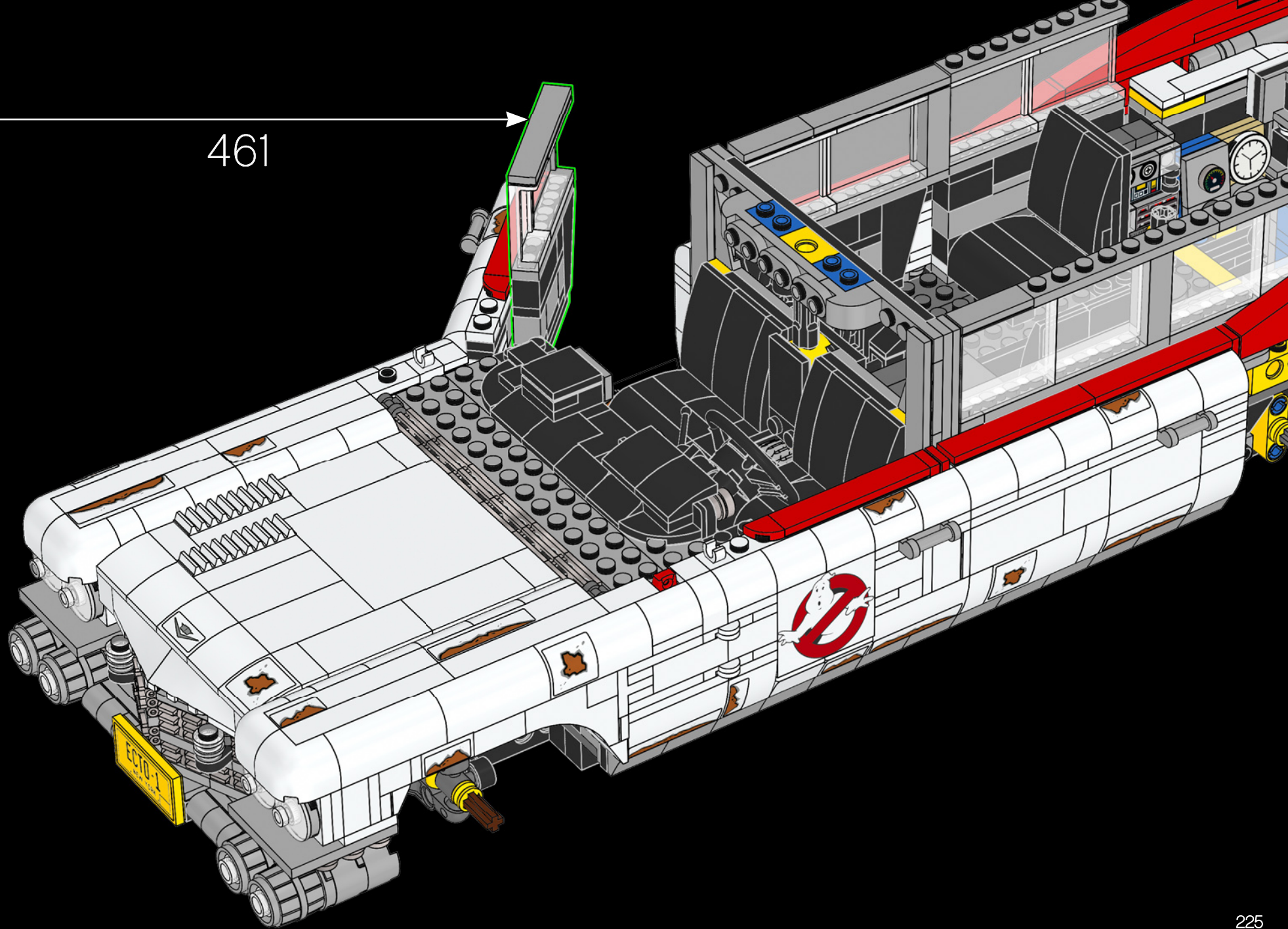

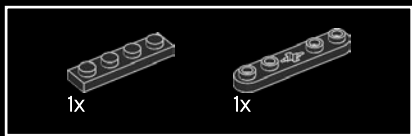

462

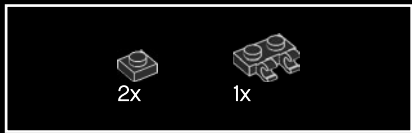
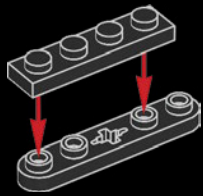

463

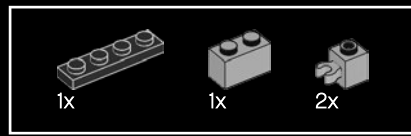
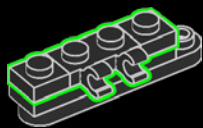

464

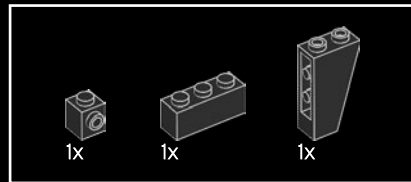
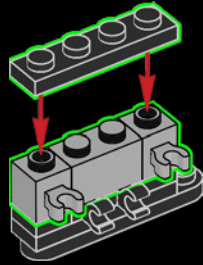

465

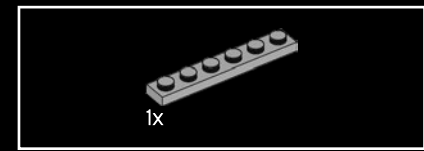
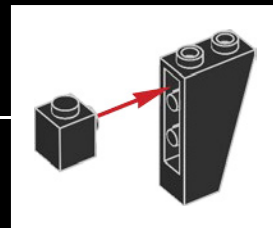
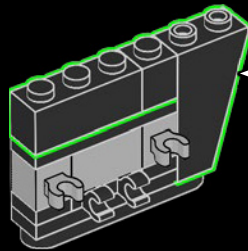

466

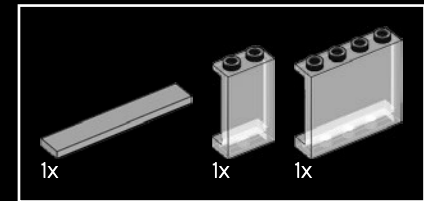
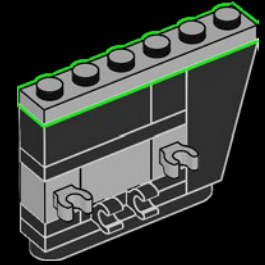

467

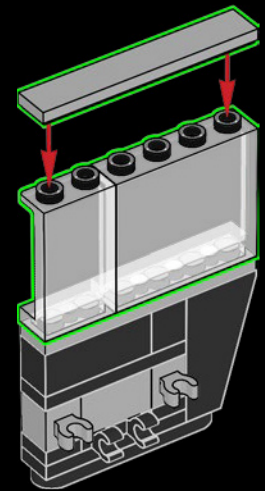

468

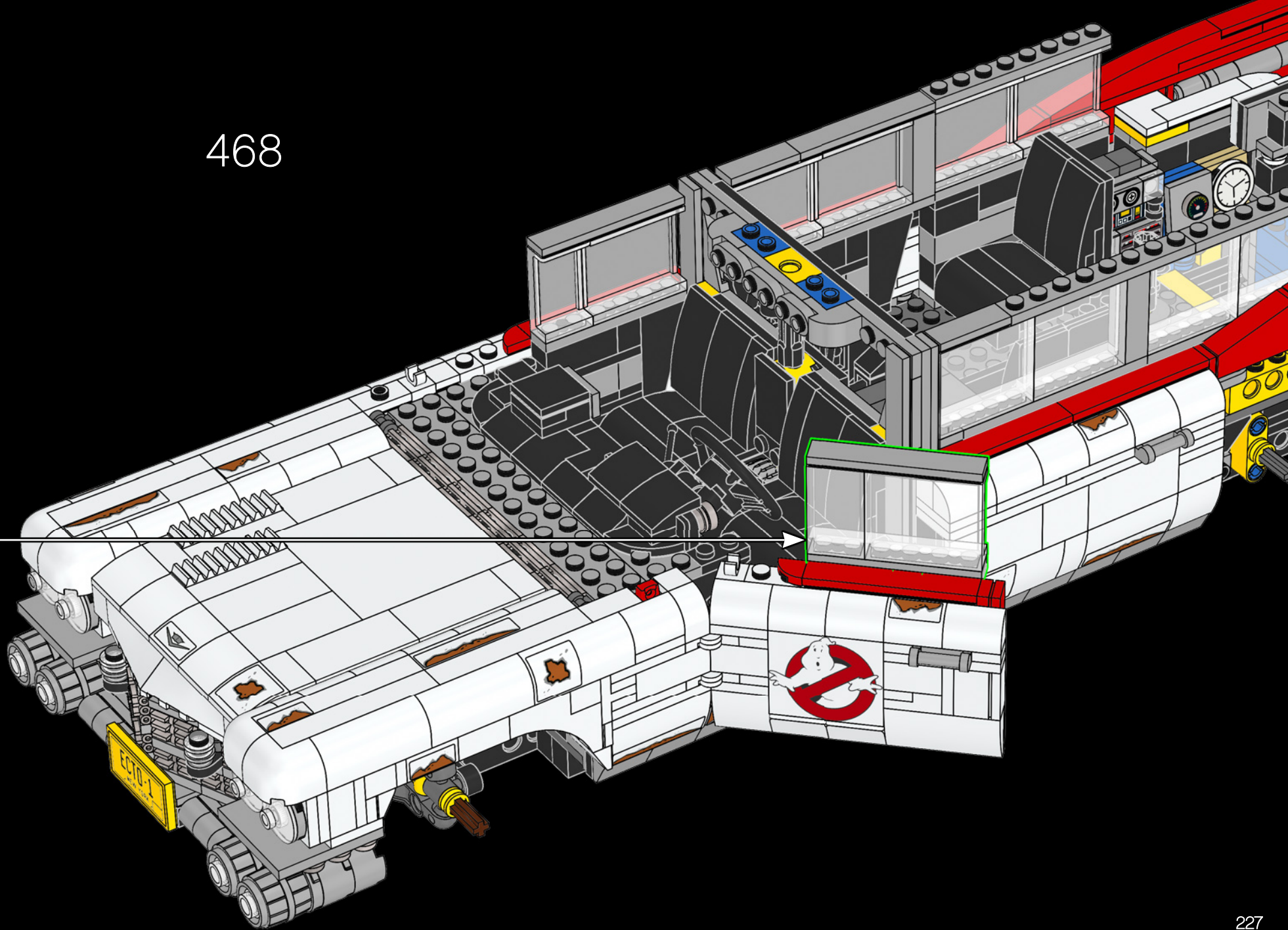

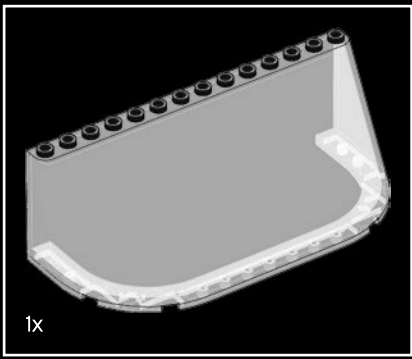

469

1

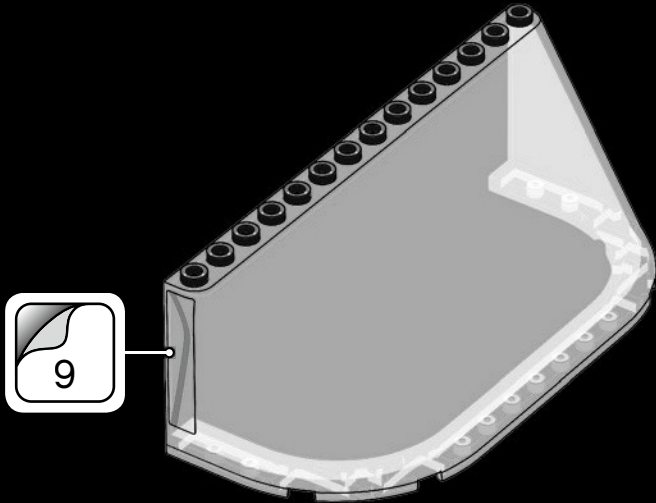

2

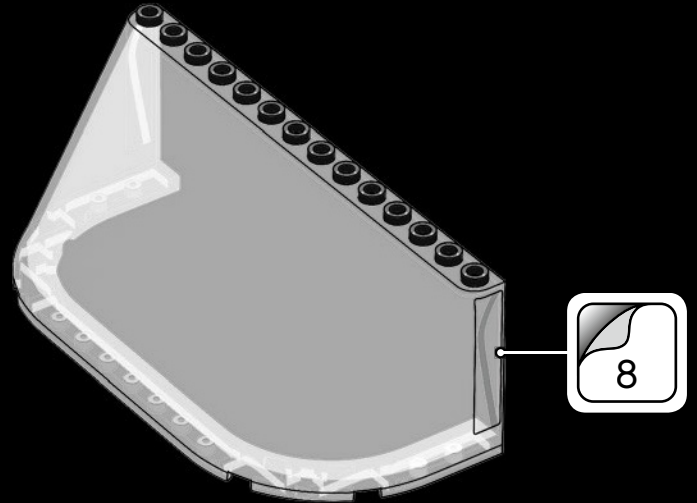

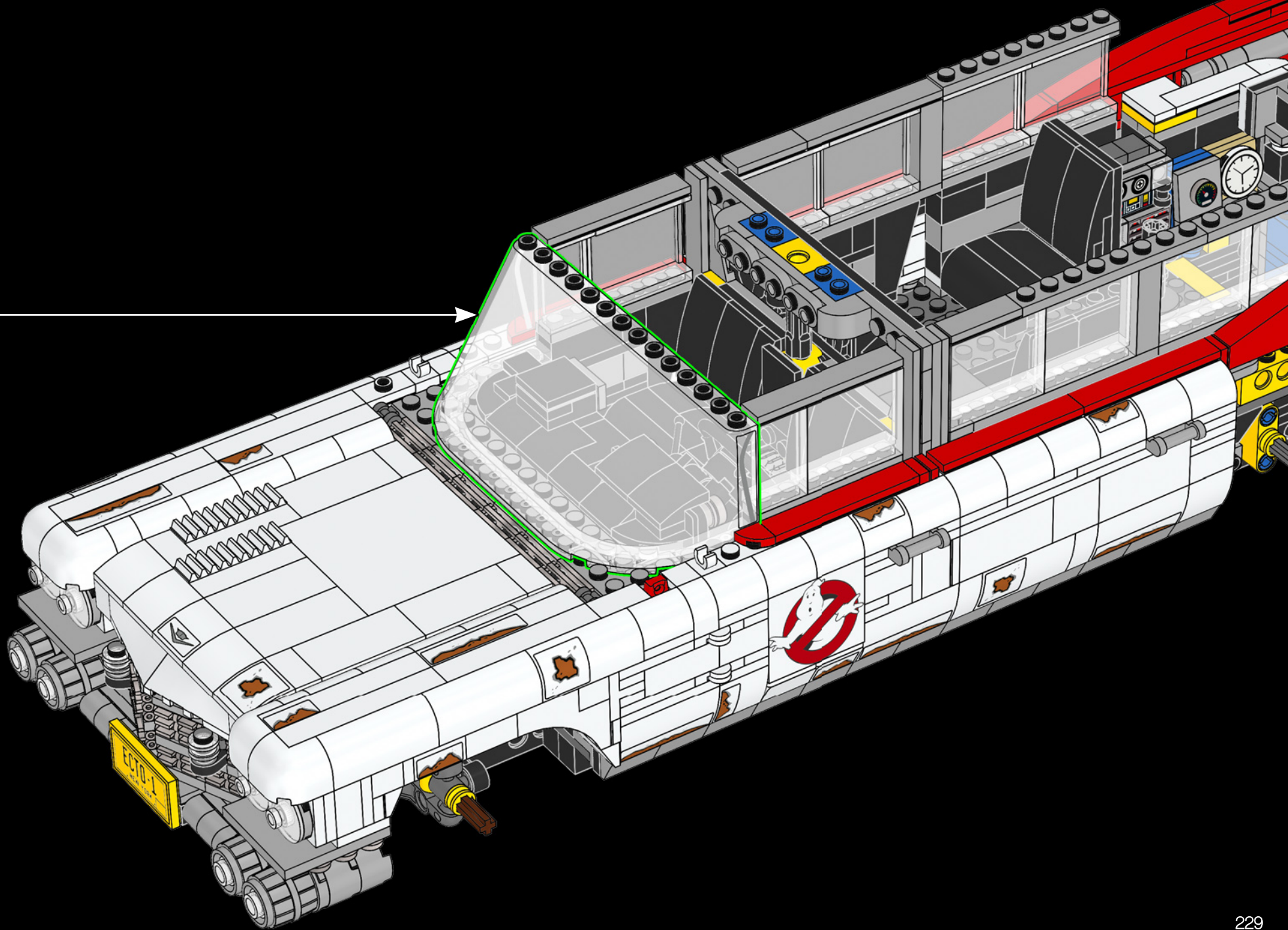

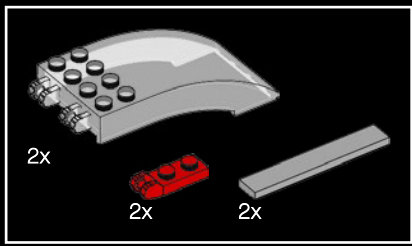

470

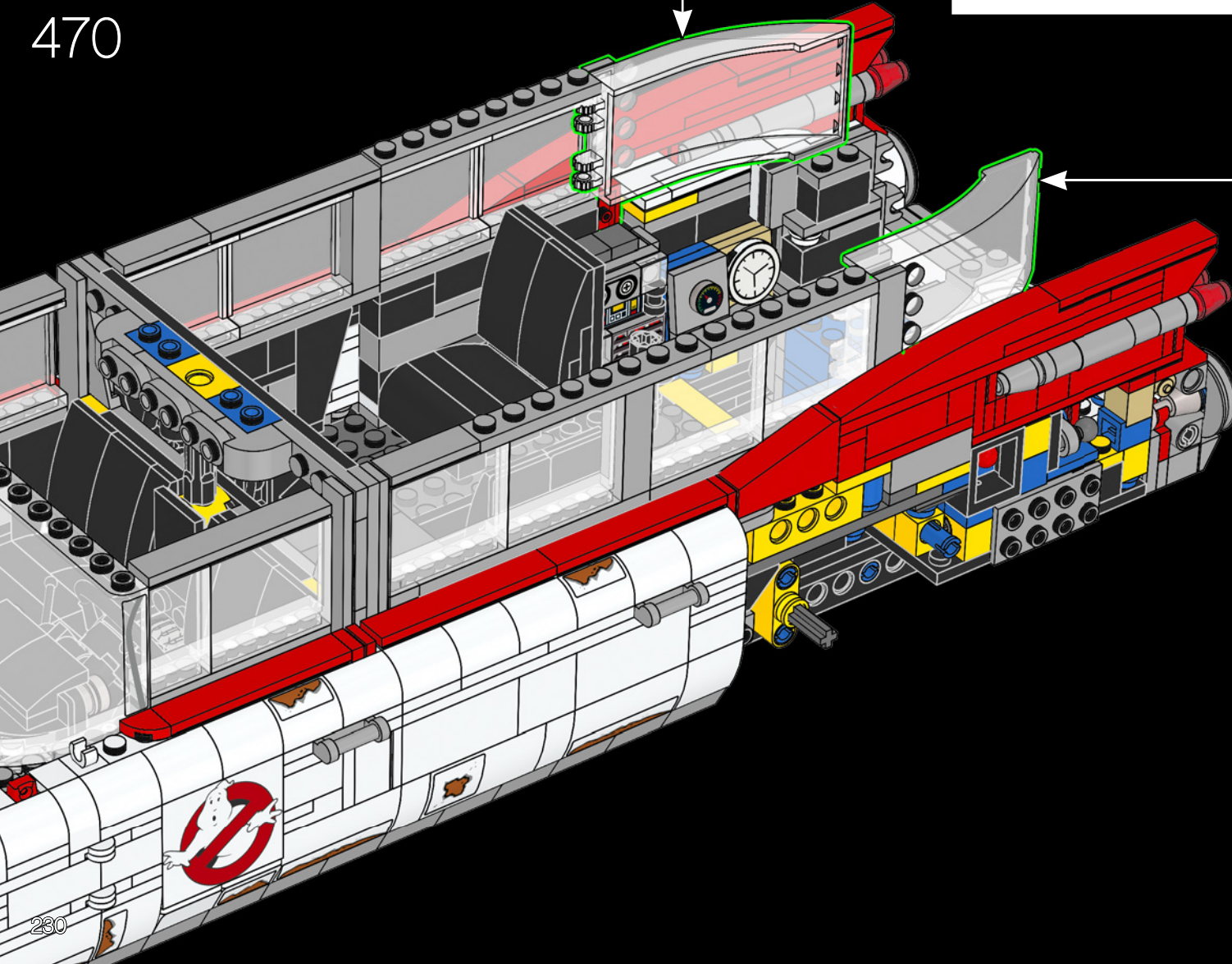
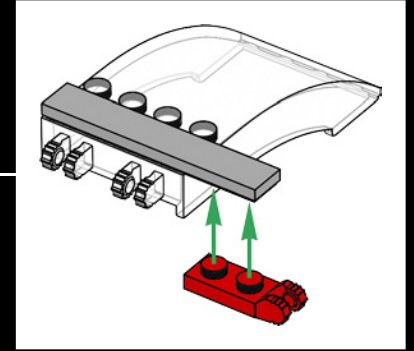
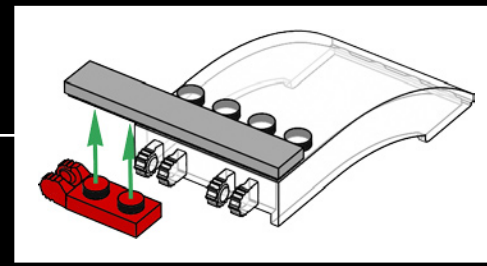

260



471

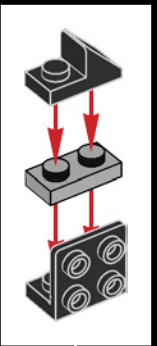
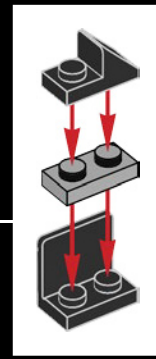
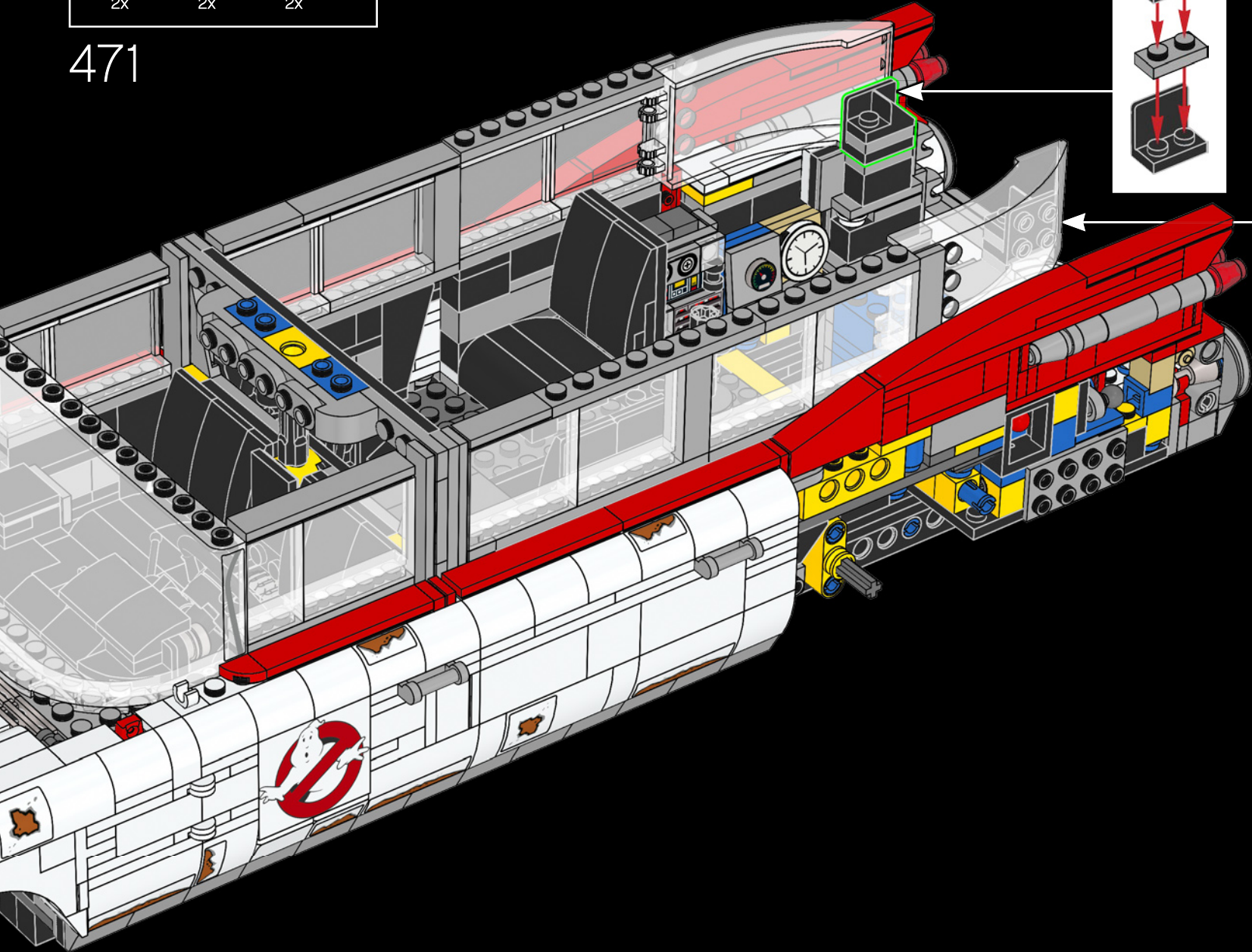

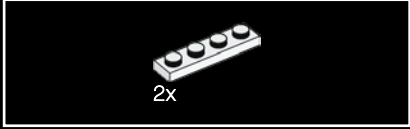
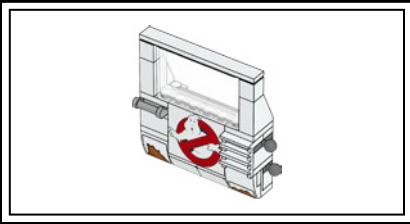

472

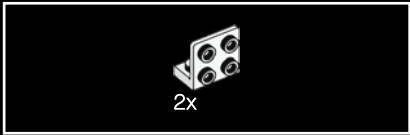
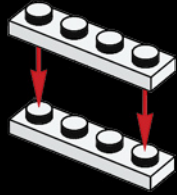

473

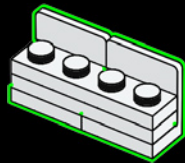

474

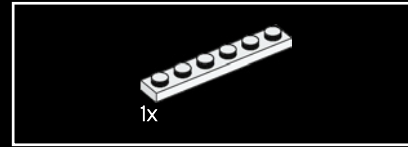
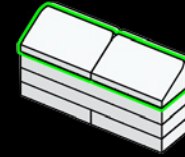

475

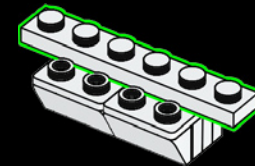



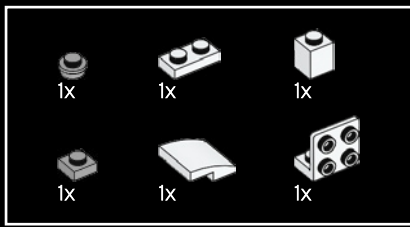

476

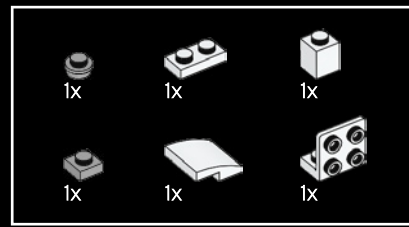
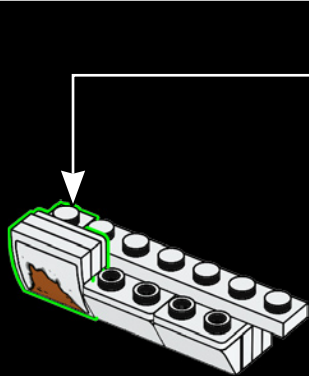
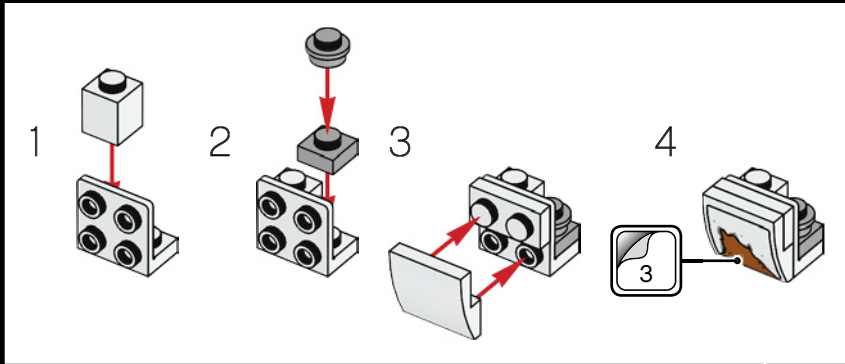

477

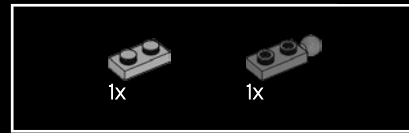
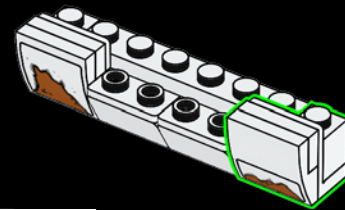
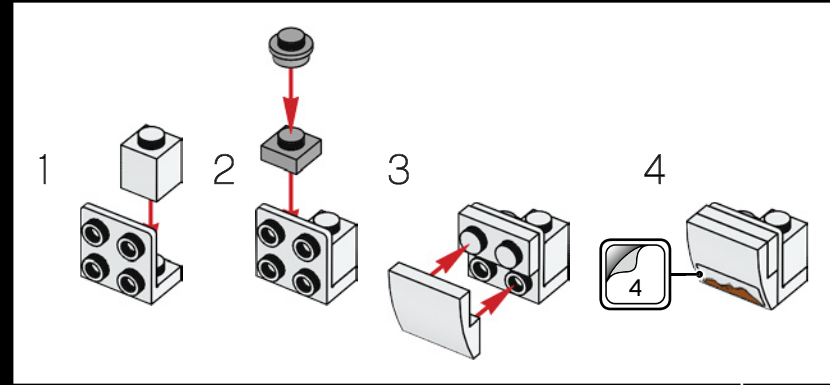

478

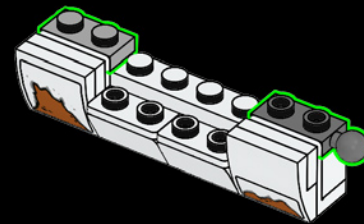

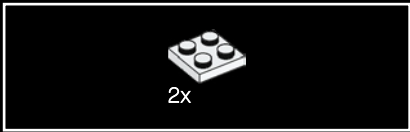

479

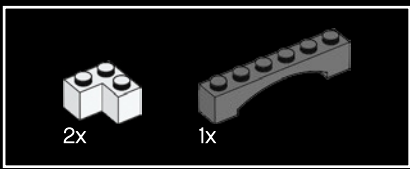
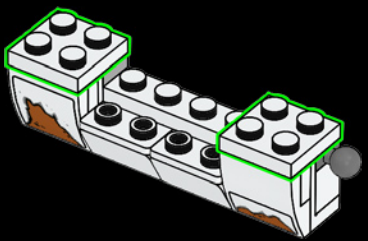

480

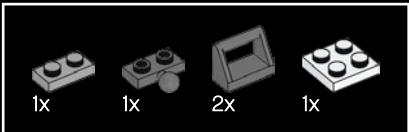
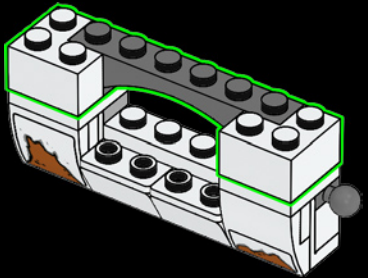

481

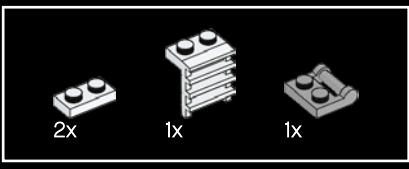
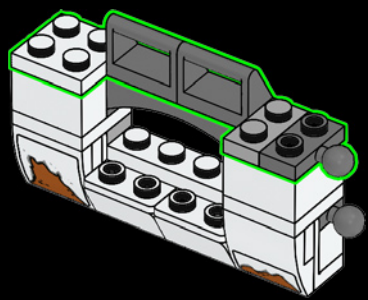

482

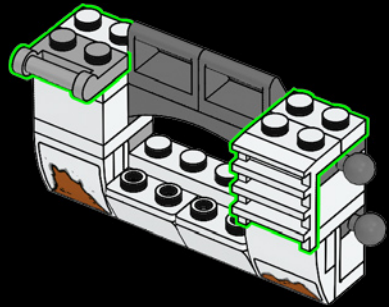

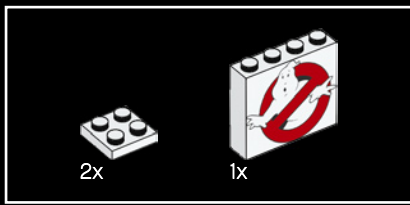

483

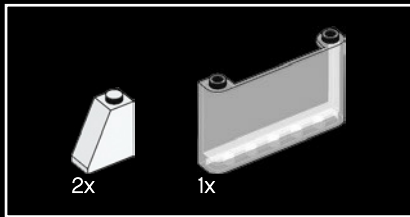
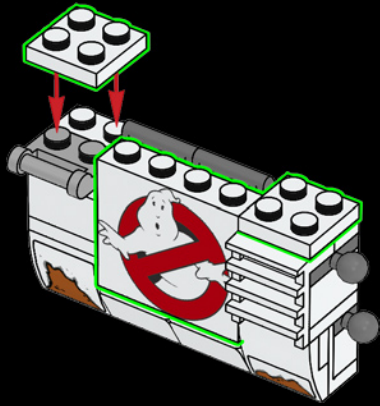

484

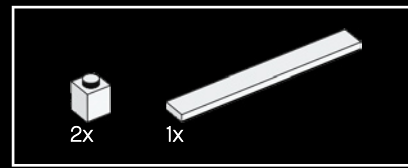
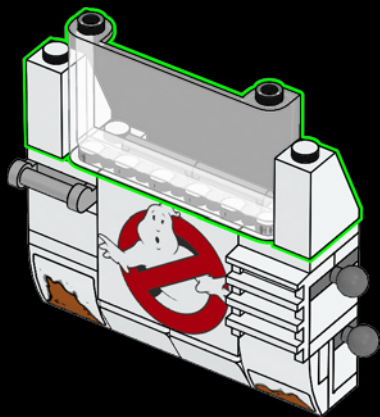

485

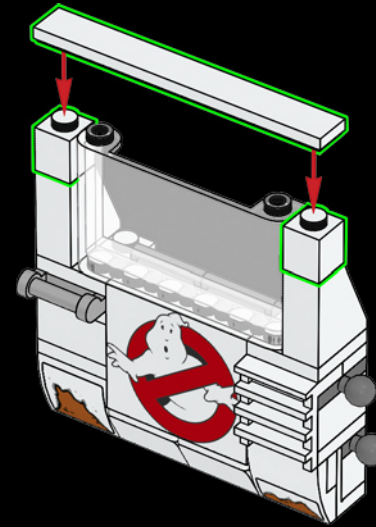

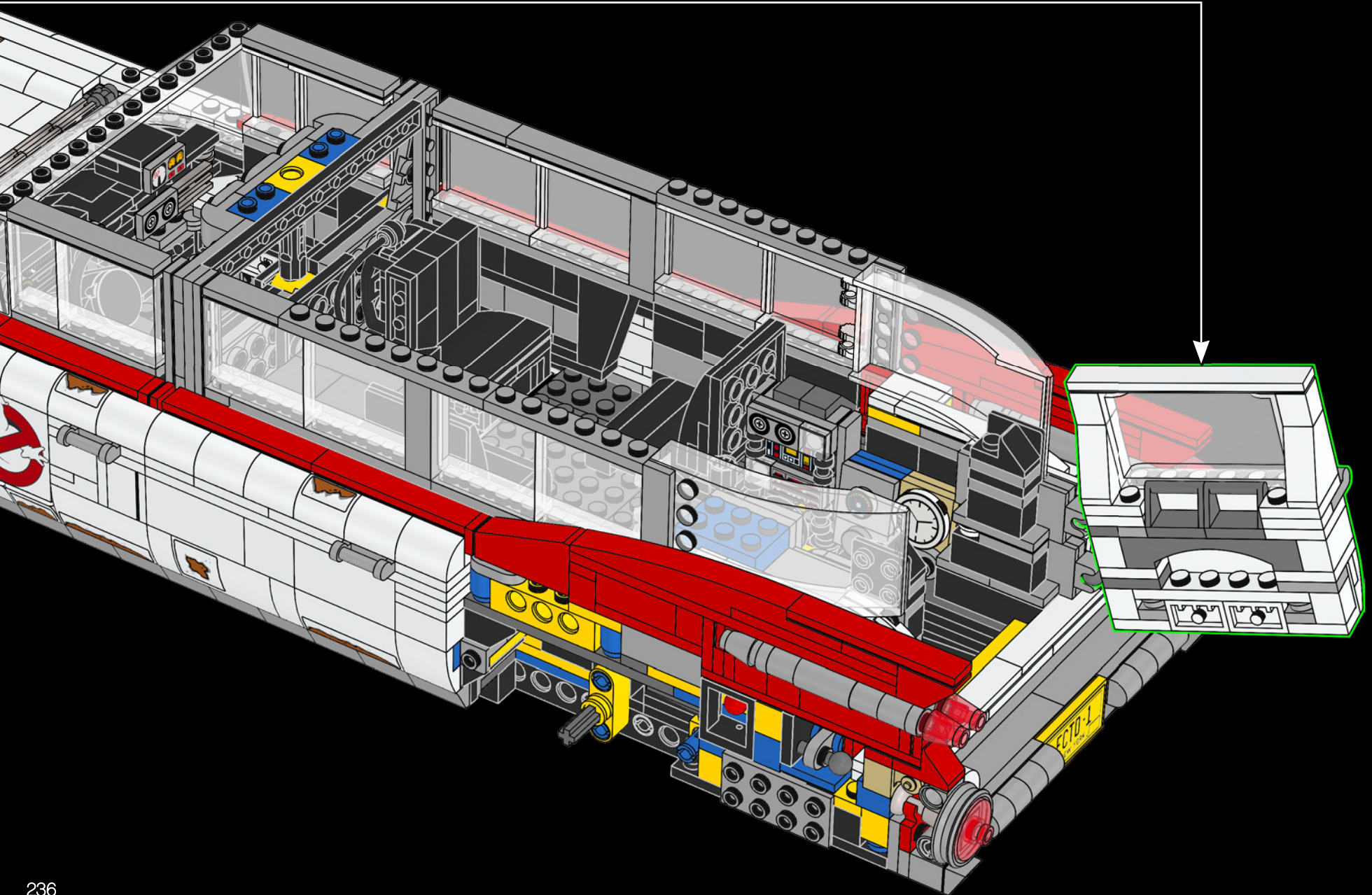

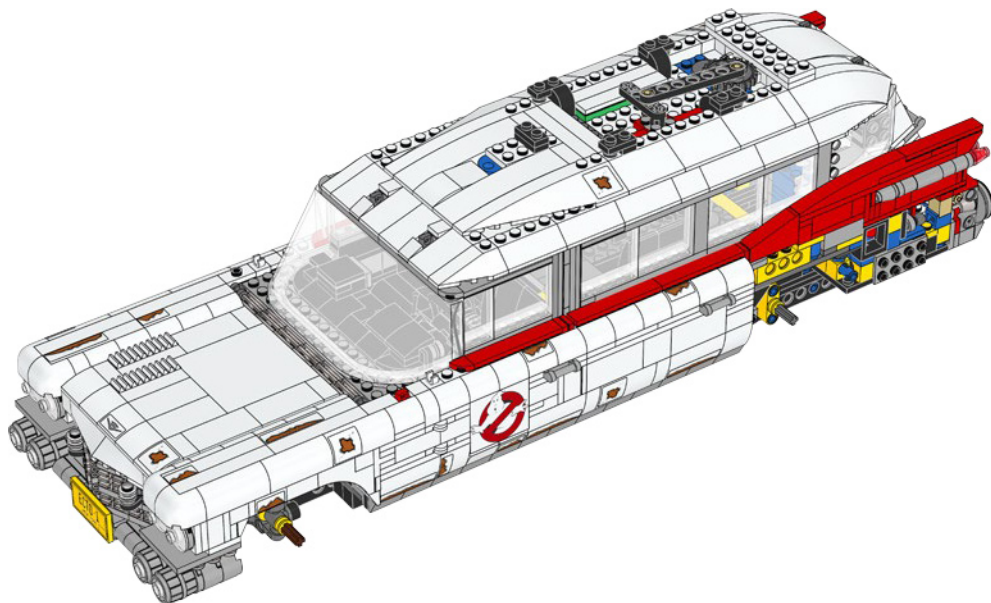
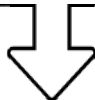

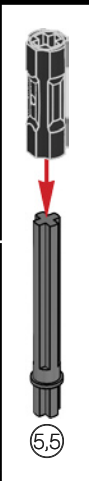
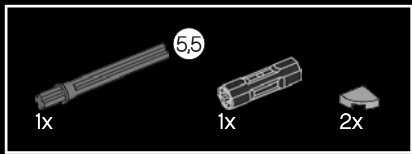

487

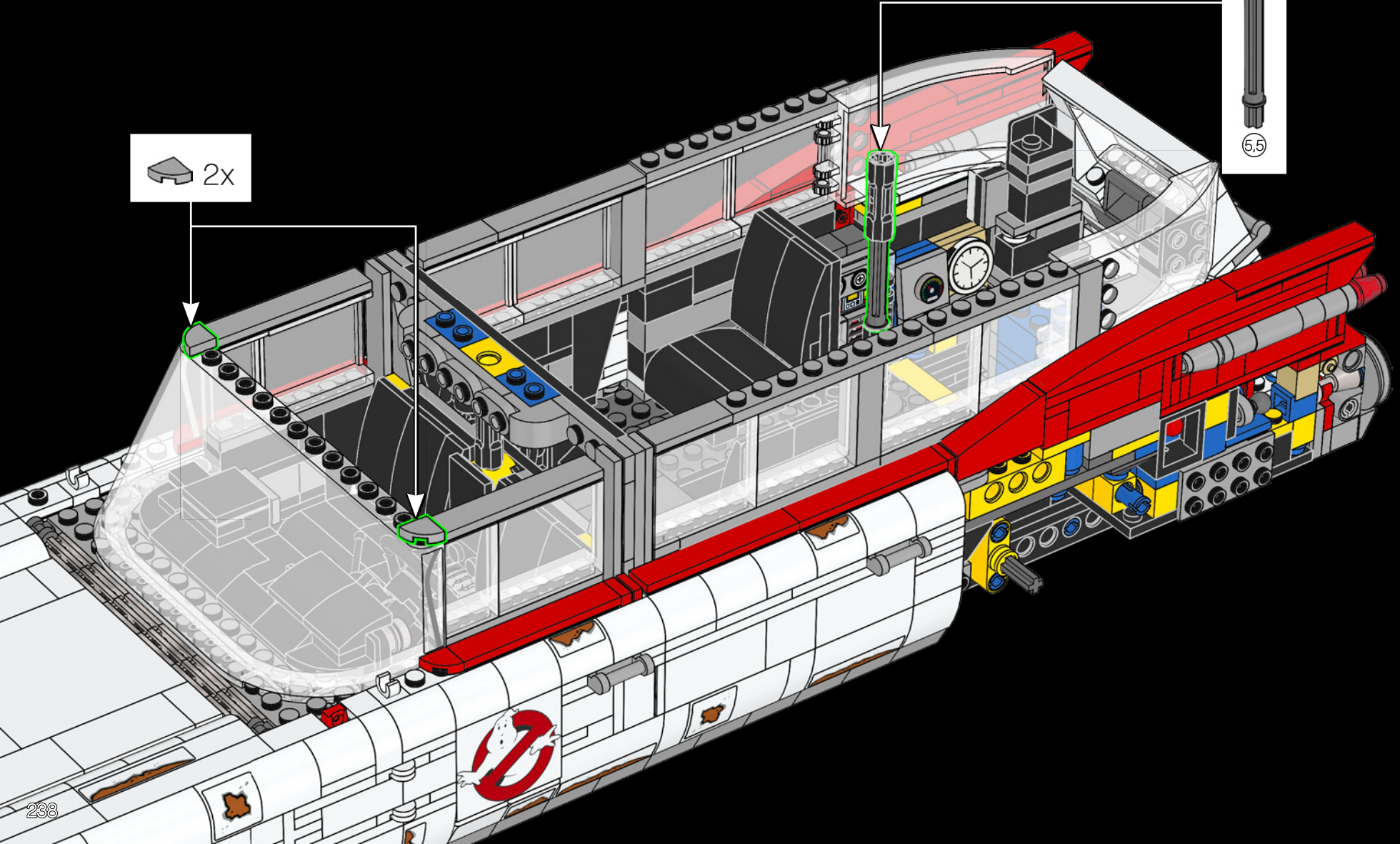

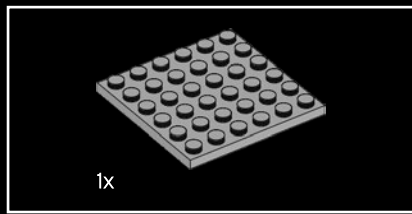

488

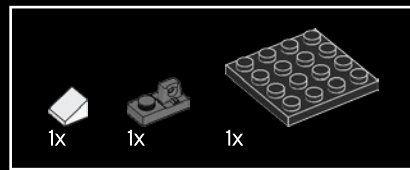

489

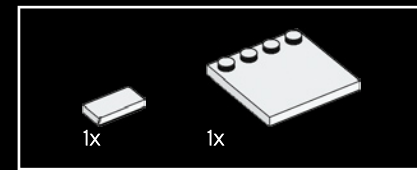
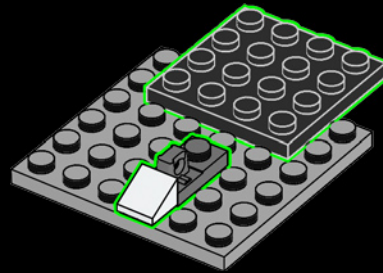

491

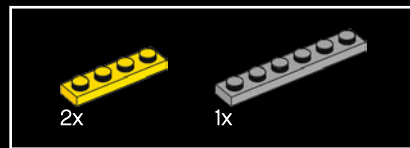
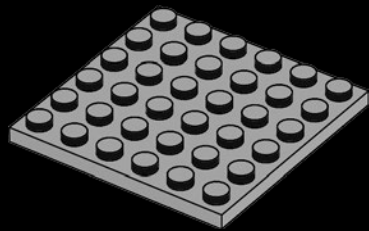
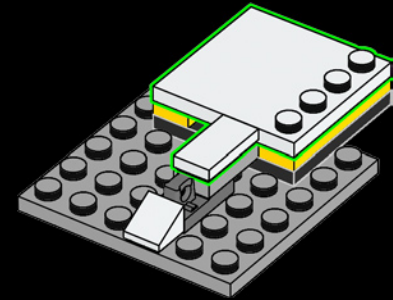

490

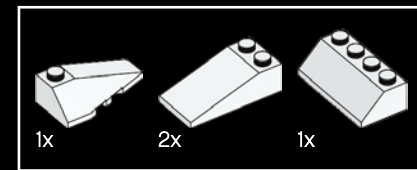
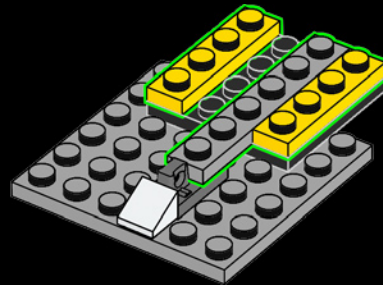

492

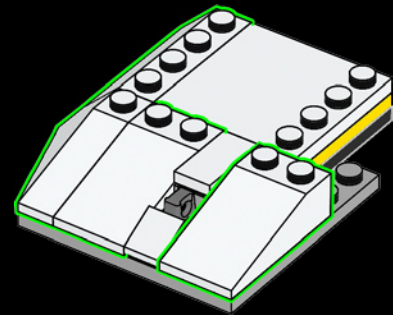

493

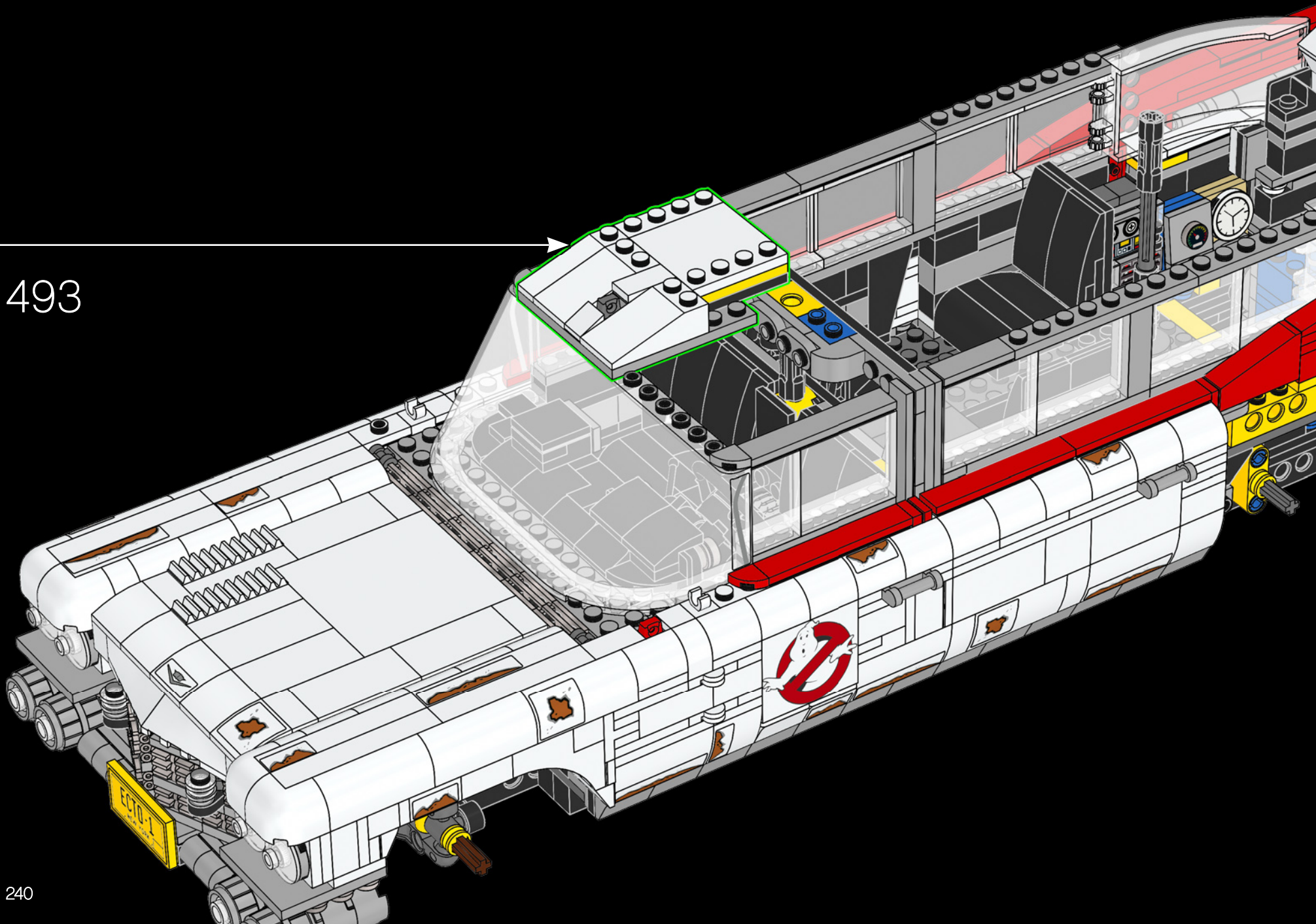



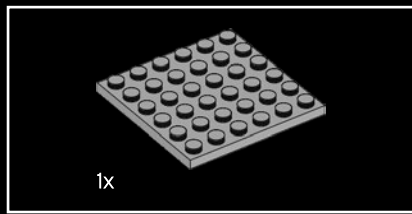

494

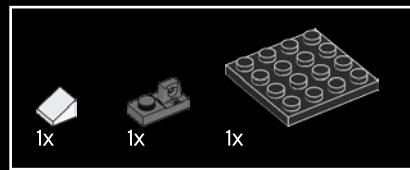

495

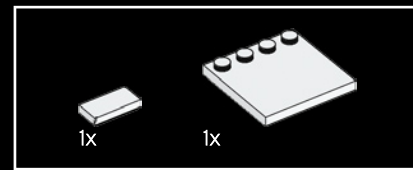

497

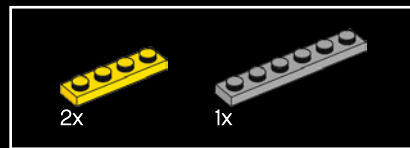
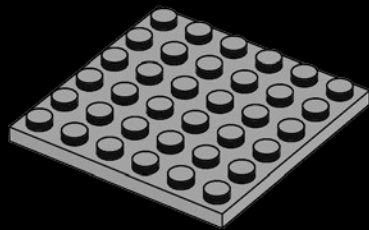
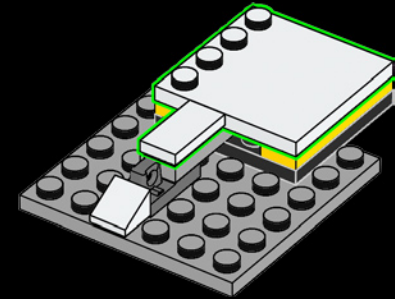
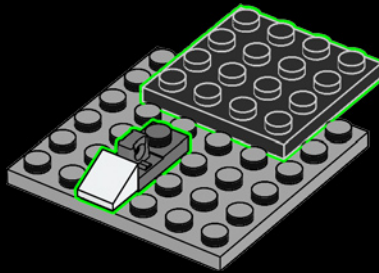

496

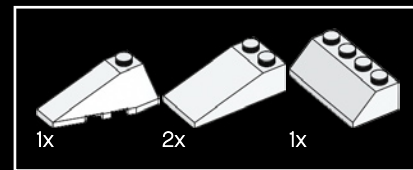

498

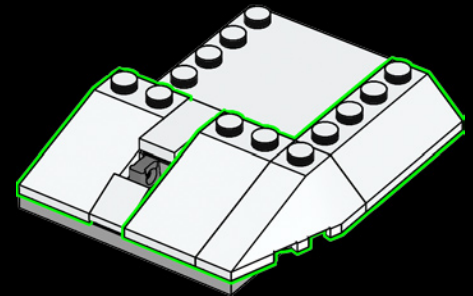
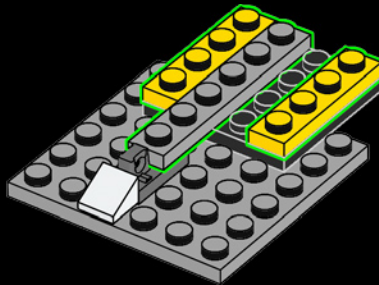

499

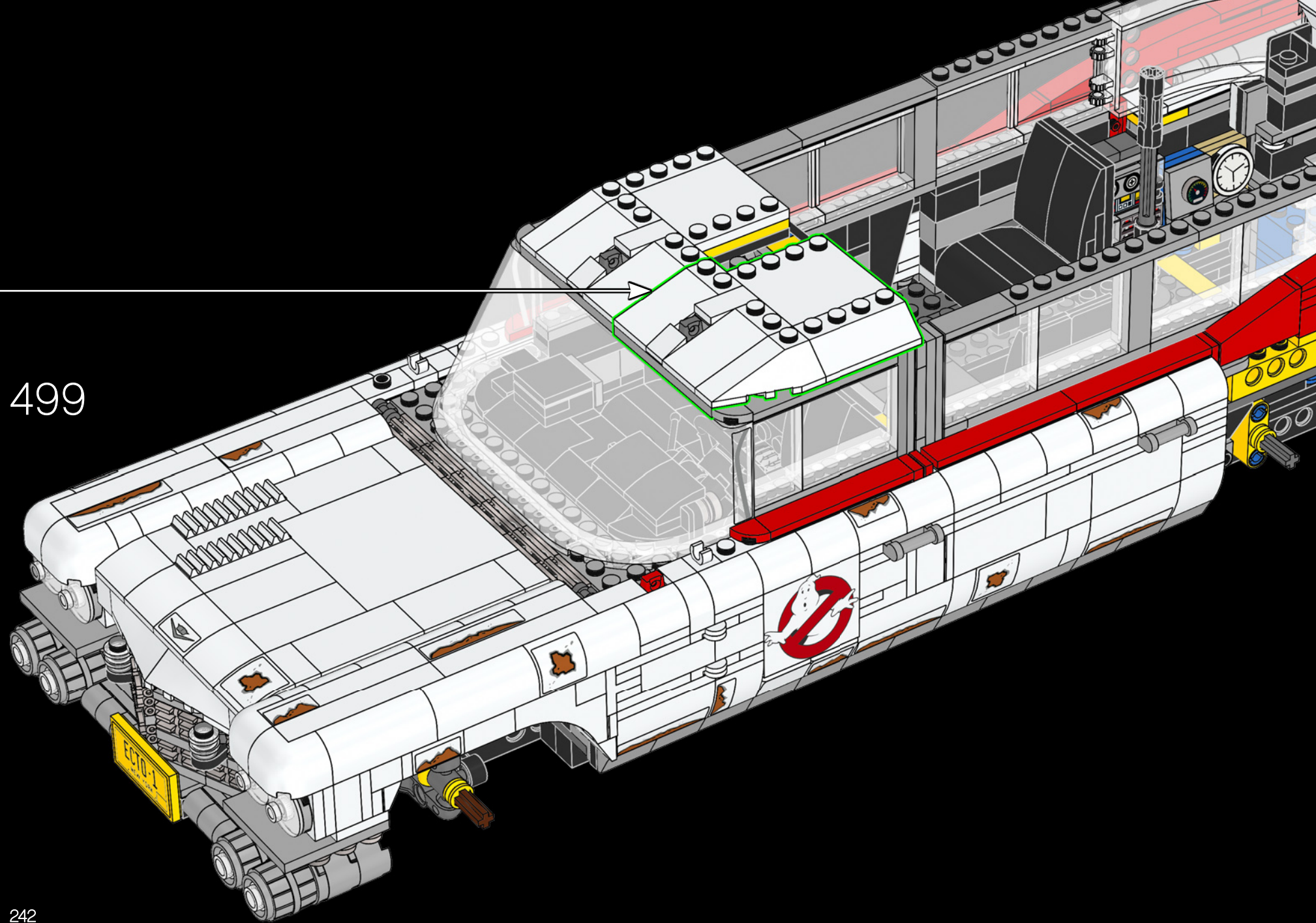

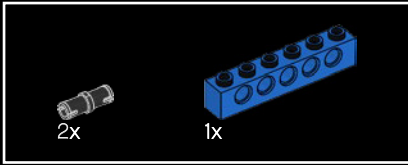
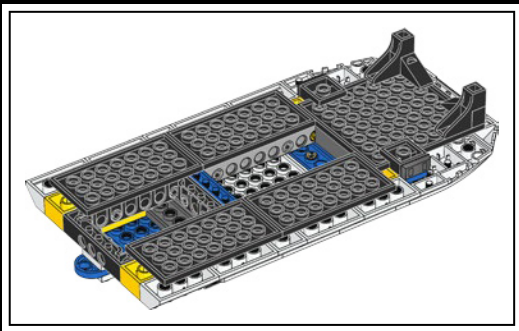

500

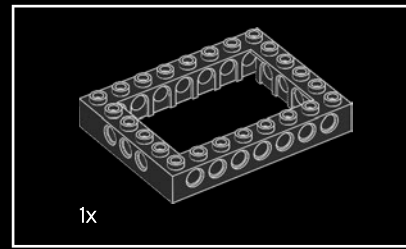
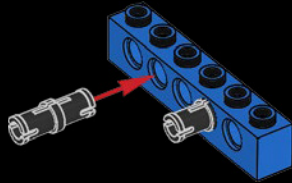

501

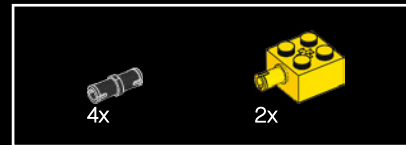
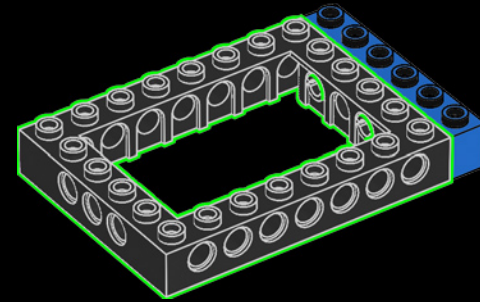

502

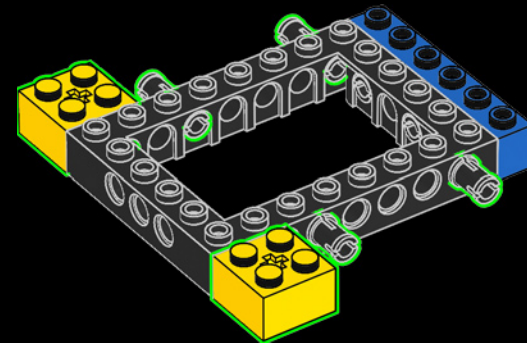

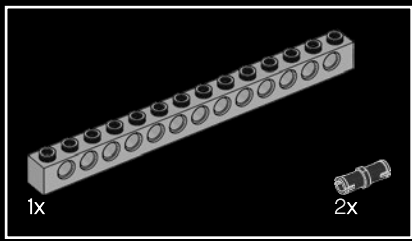

503

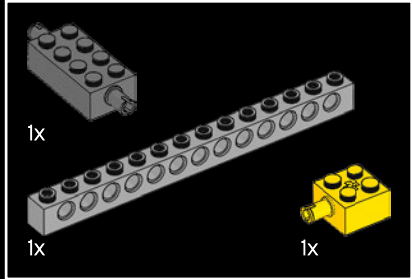
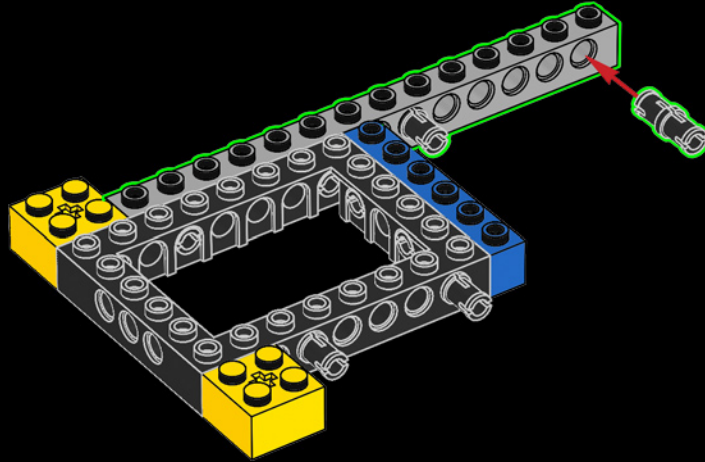

504

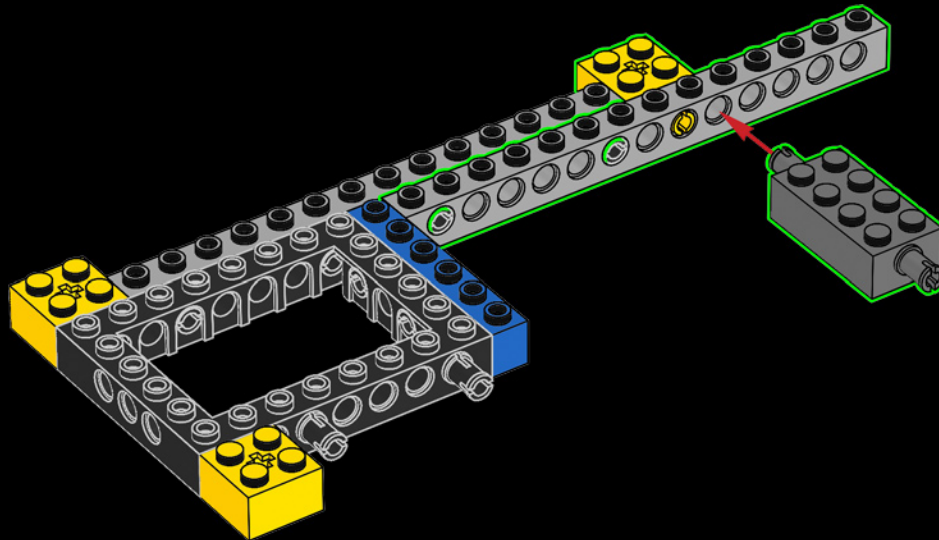

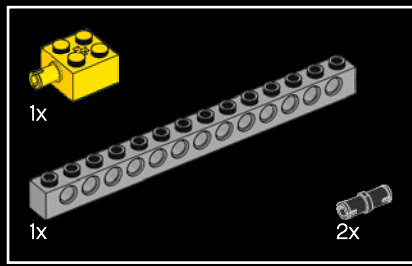

505

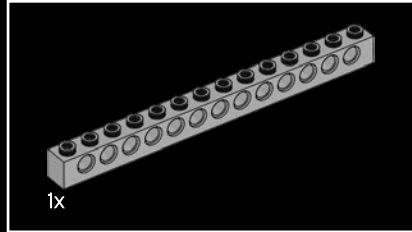
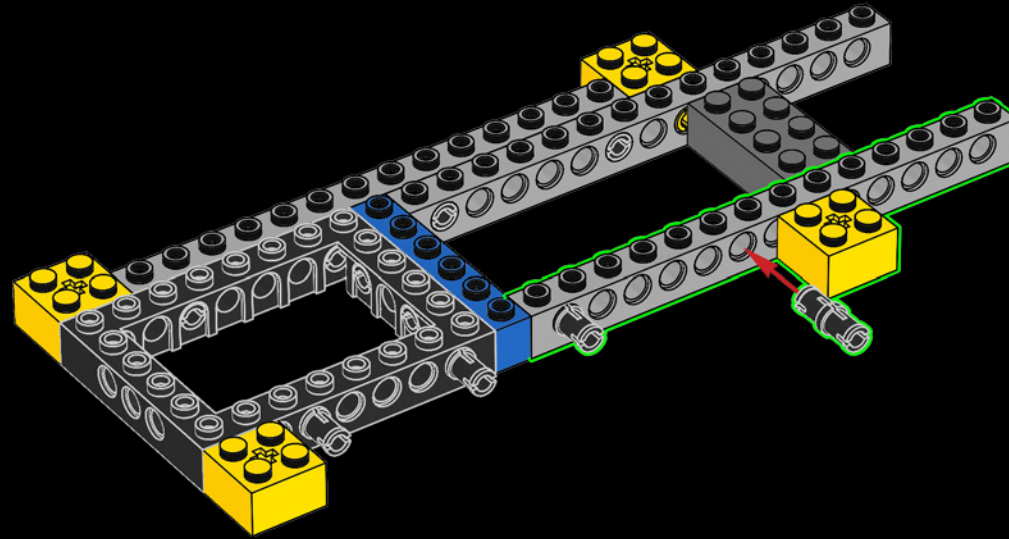

506

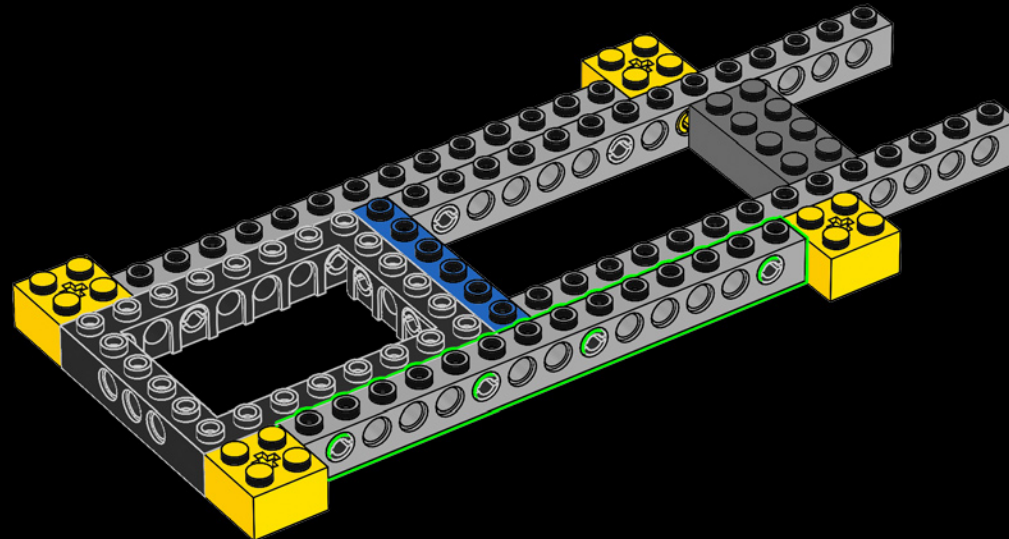

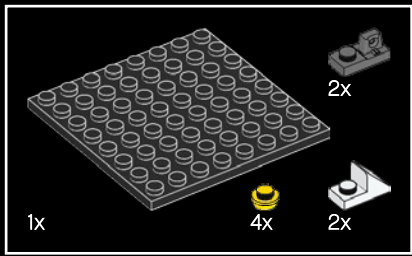

507

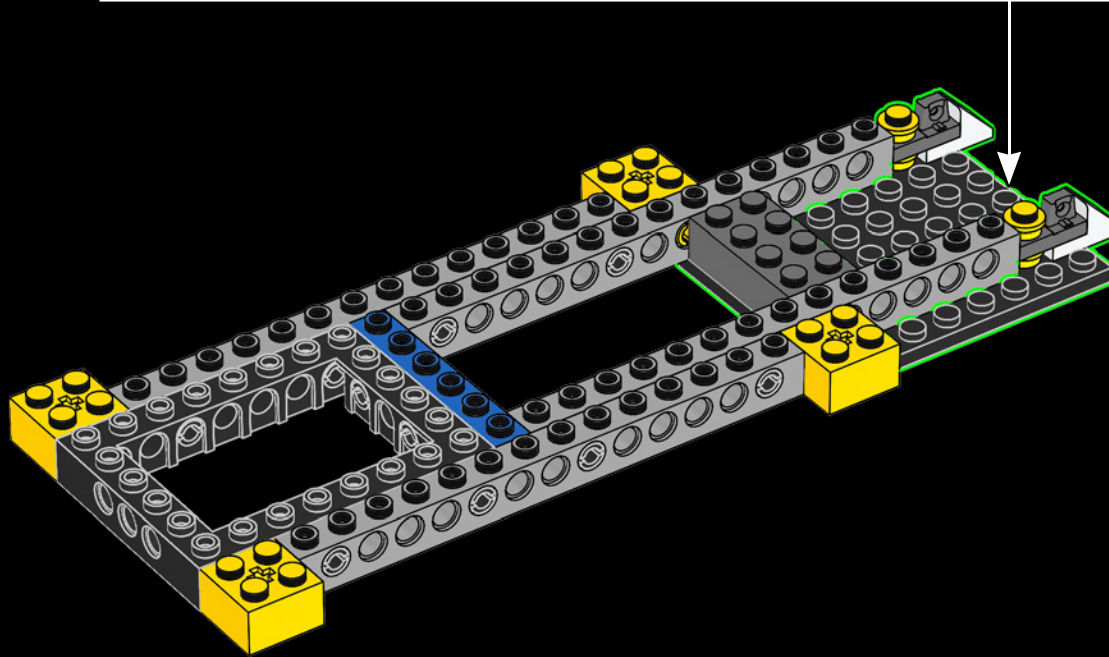
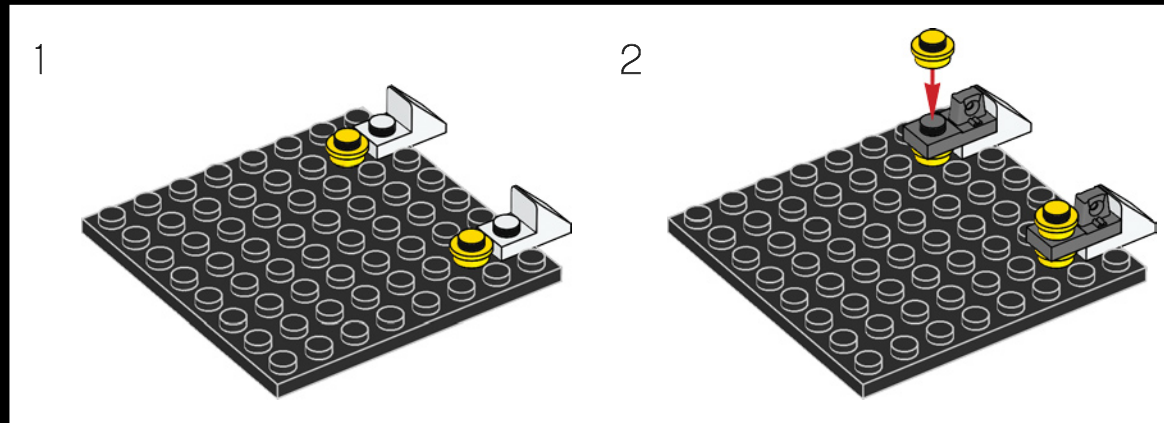



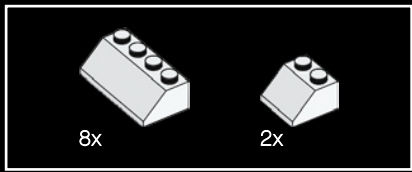

510

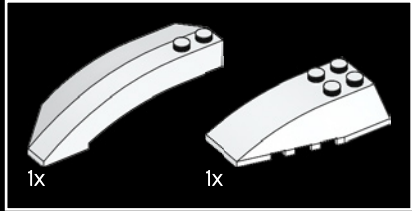
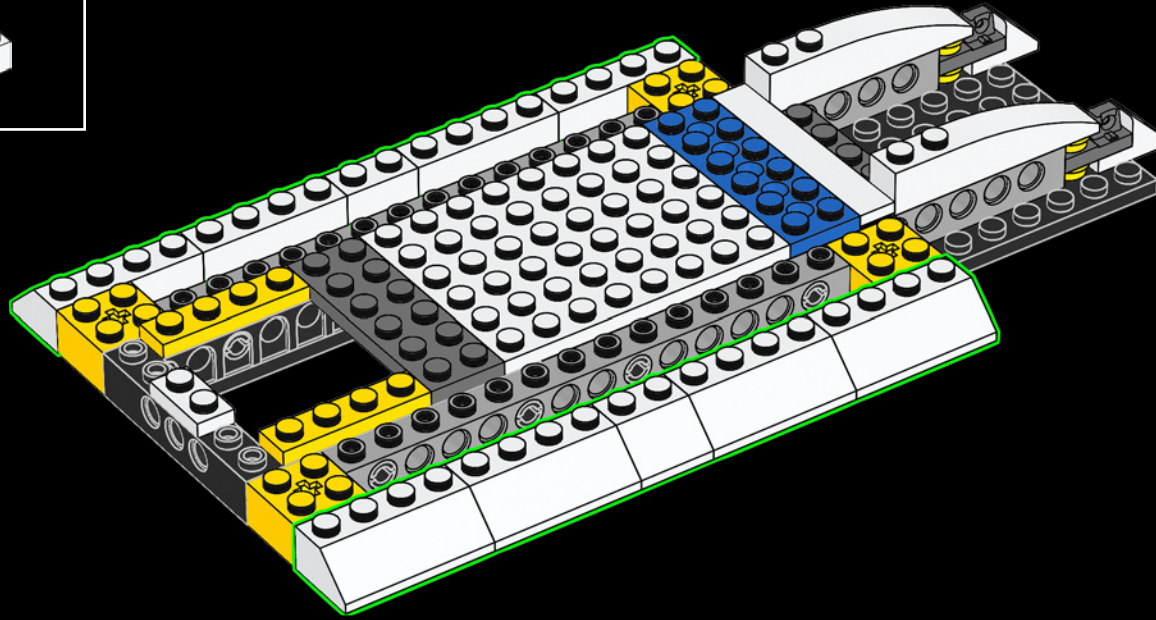

511

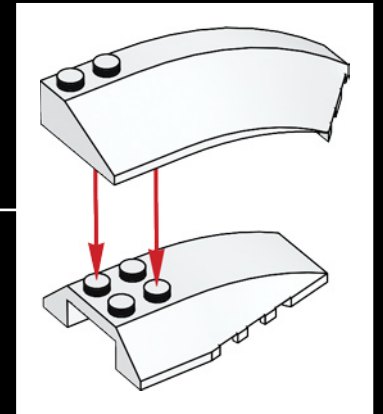
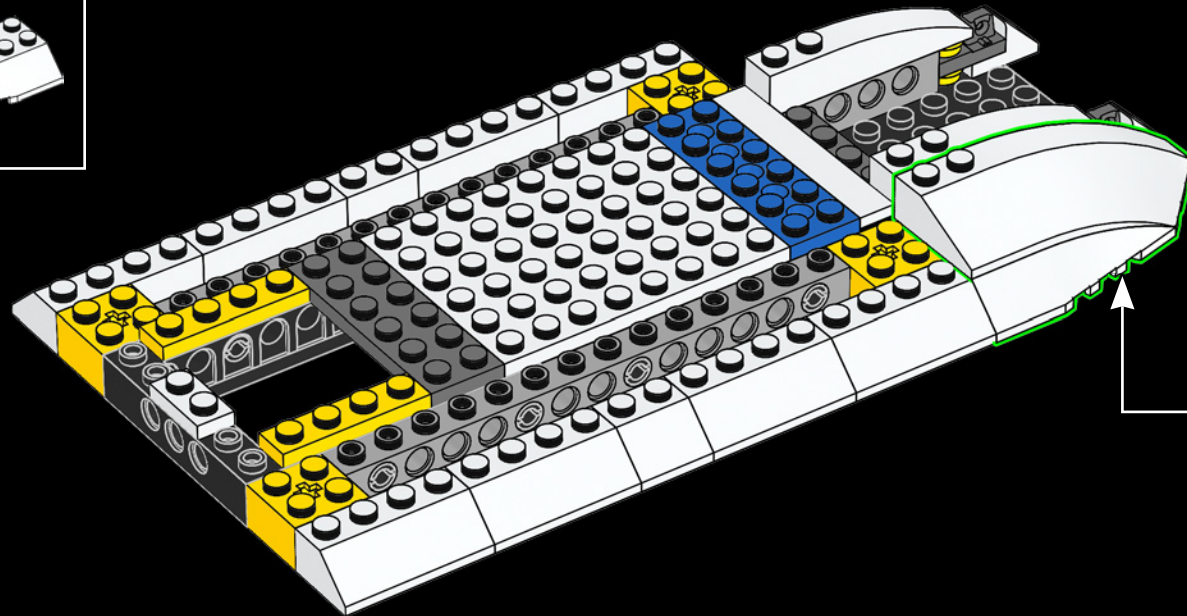



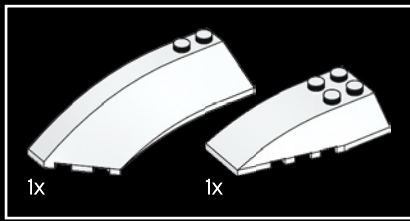

512

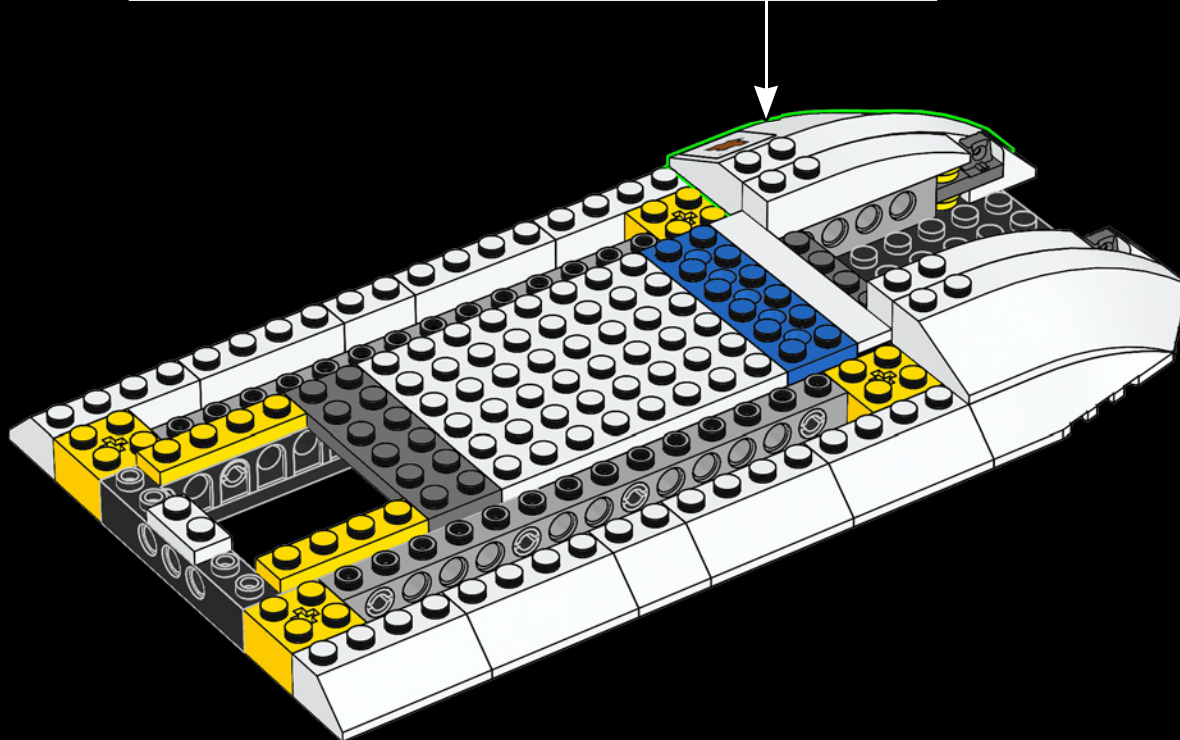
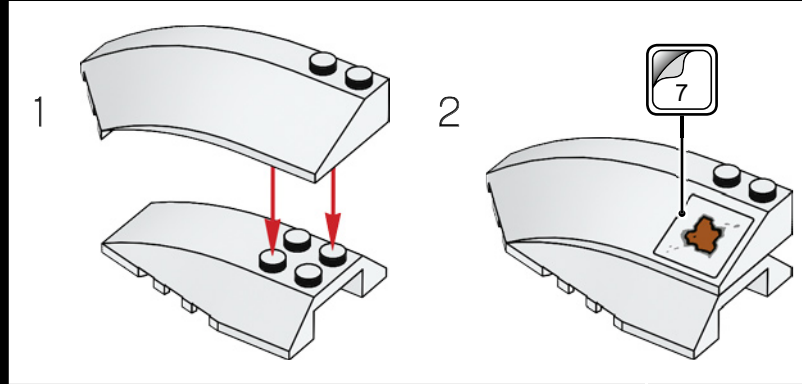

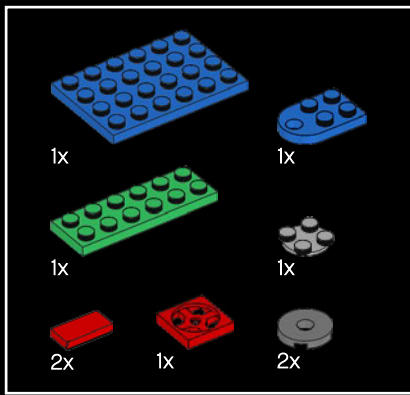

513

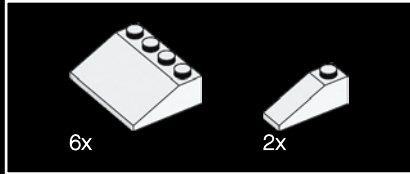
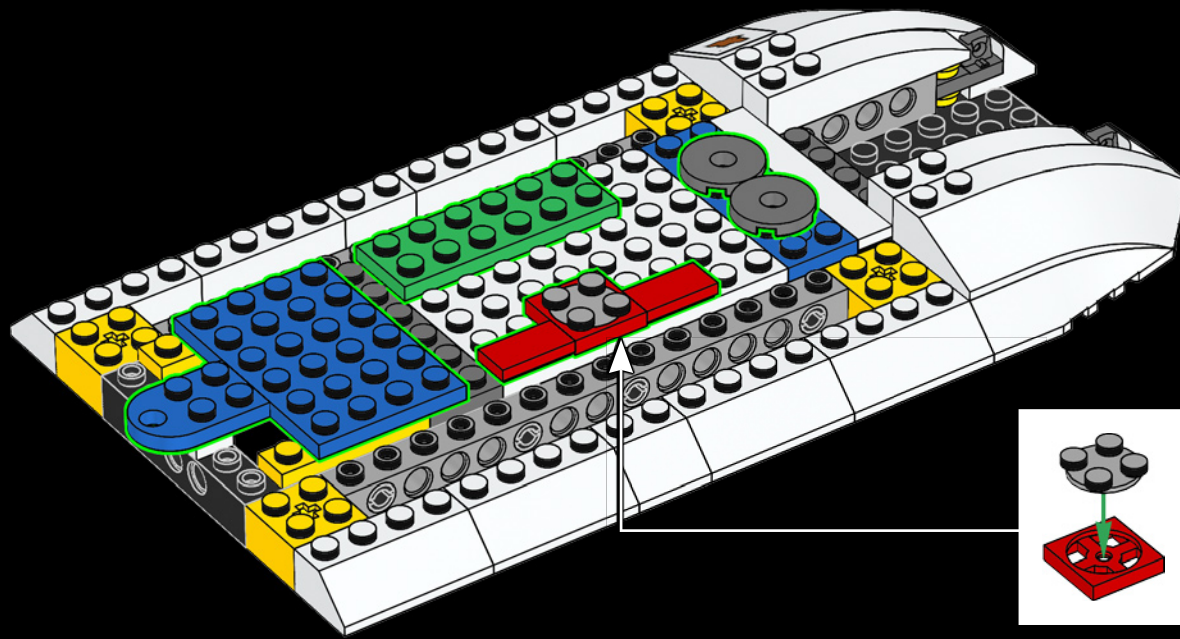

514

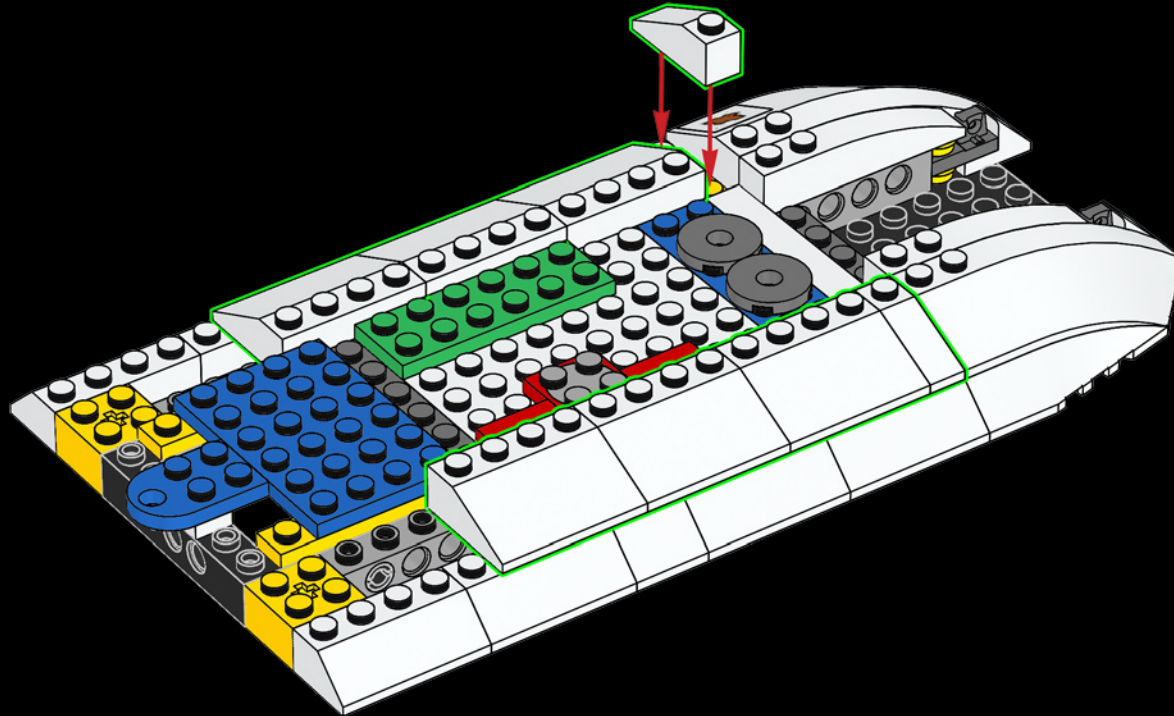

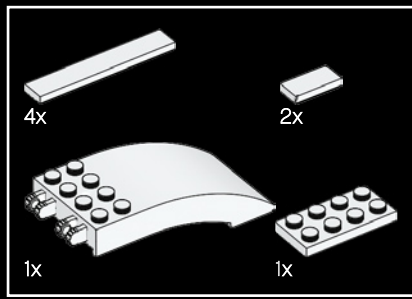

515

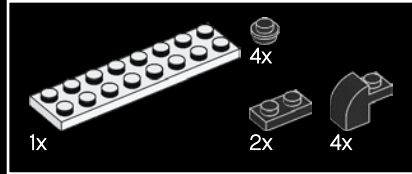
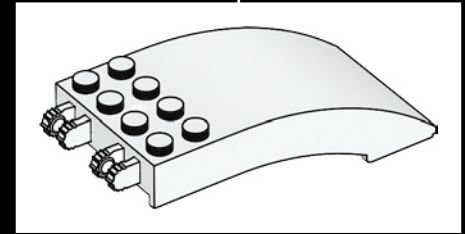
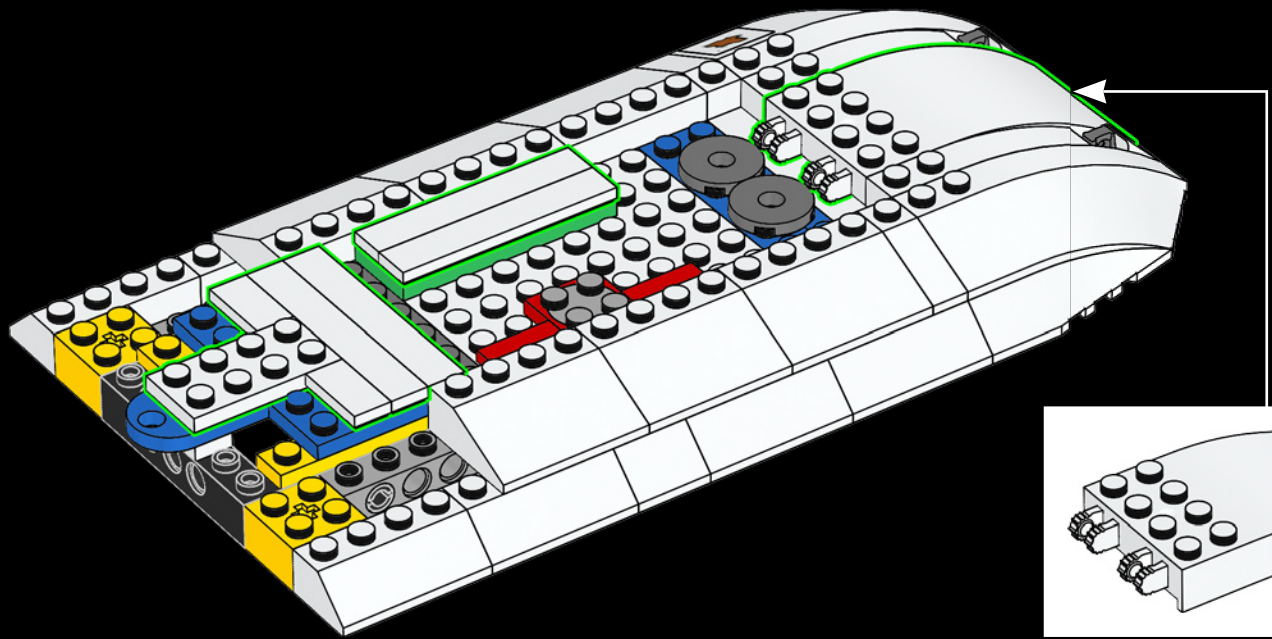

516

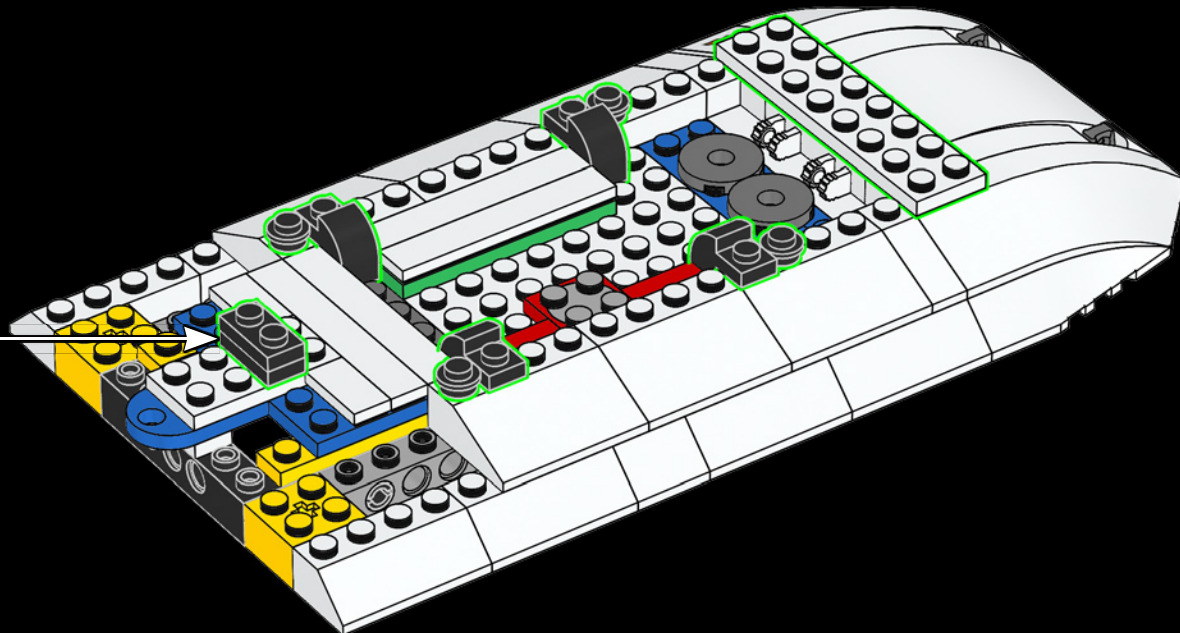
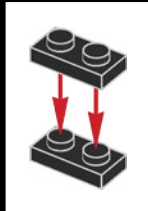



517

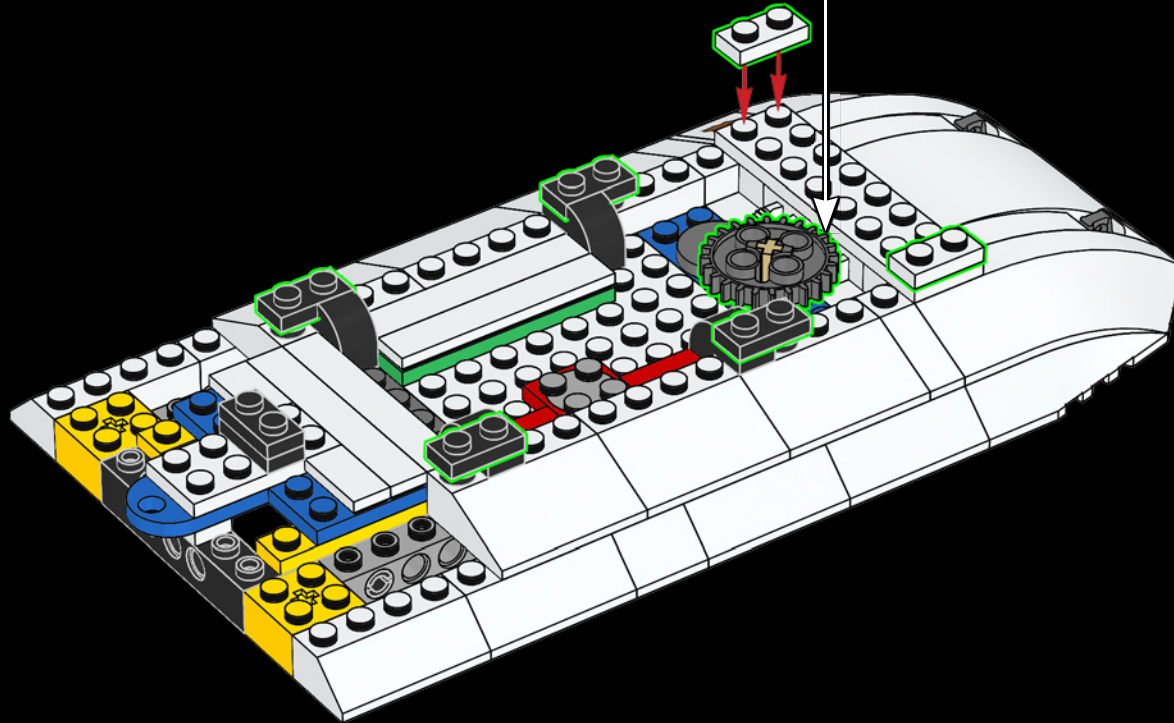
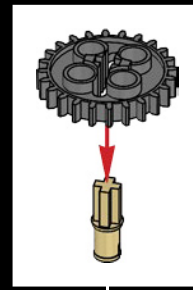

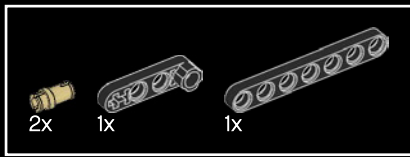

518

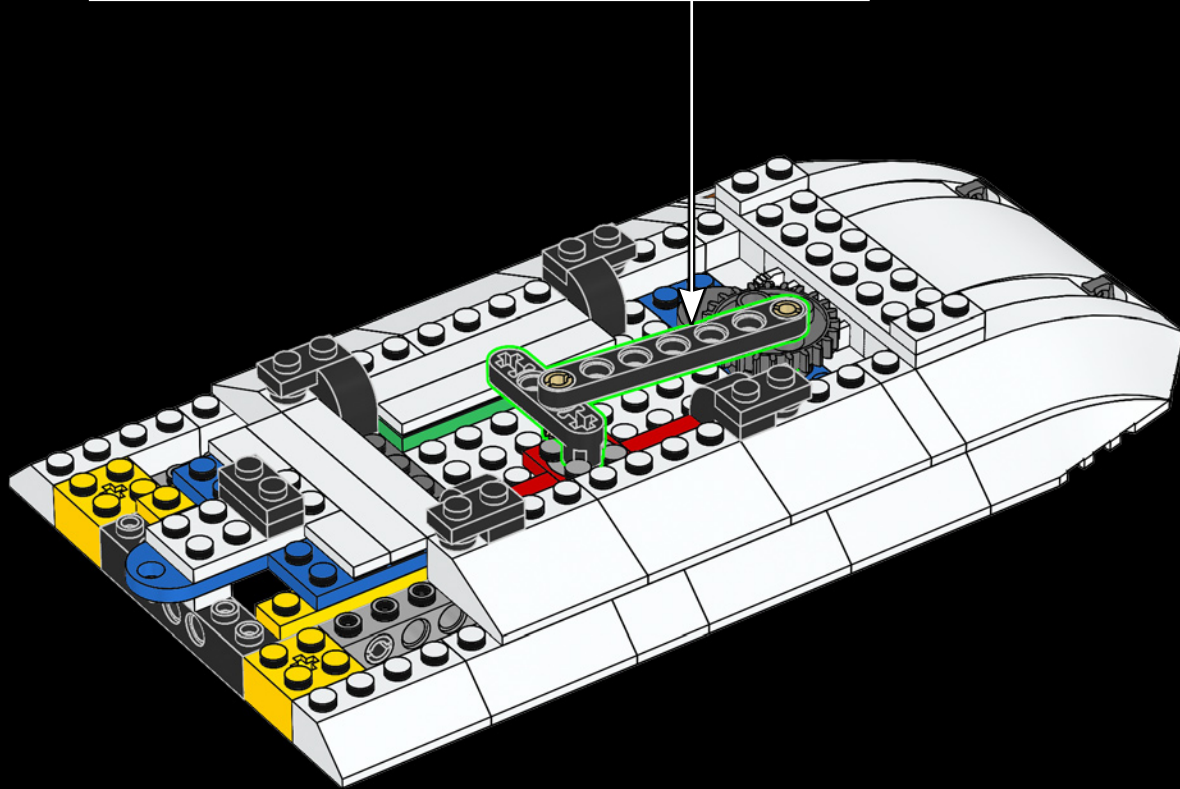
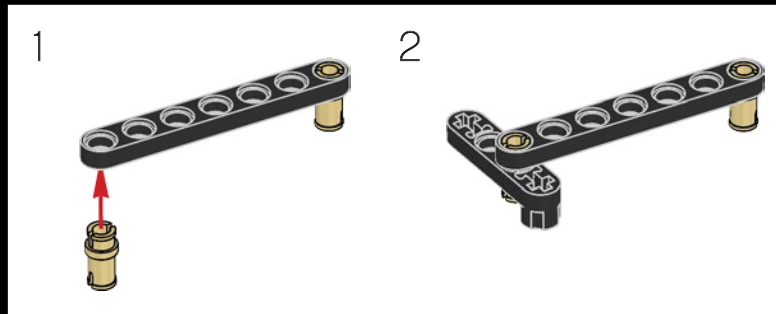

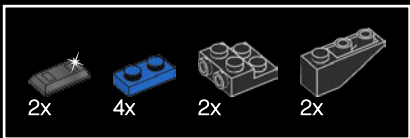

519

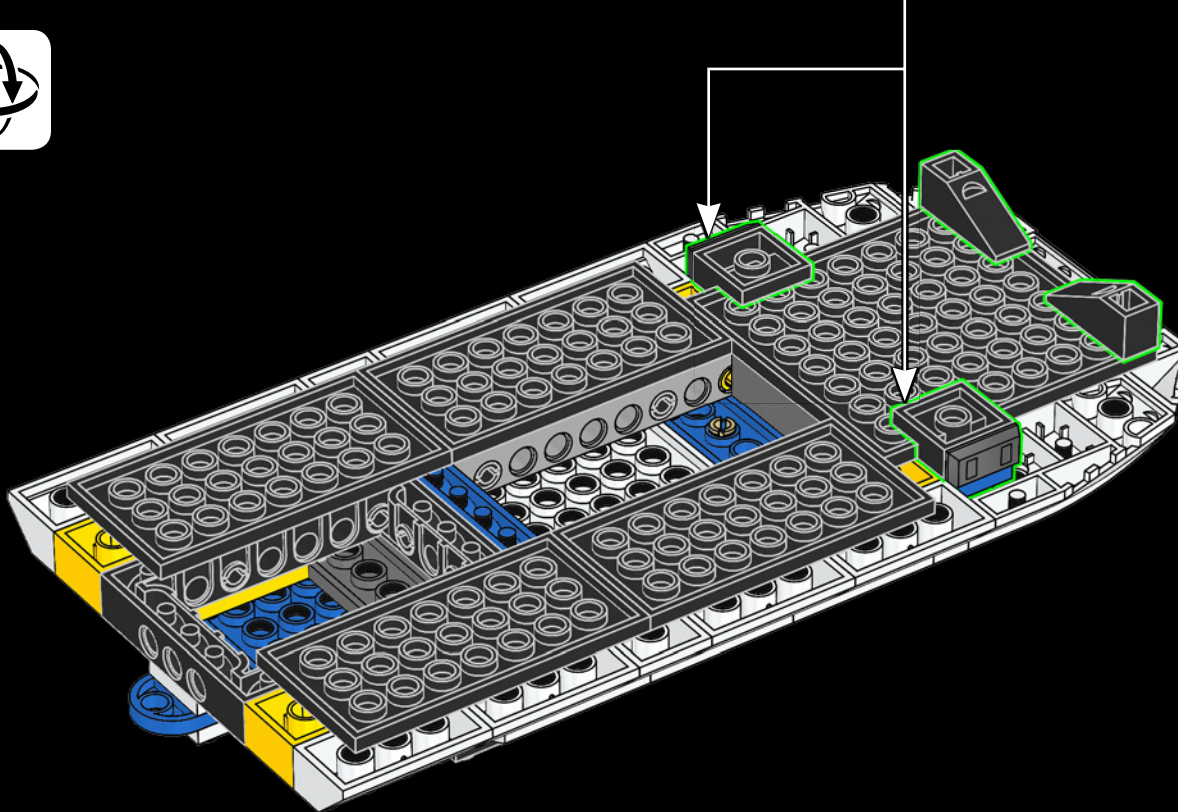
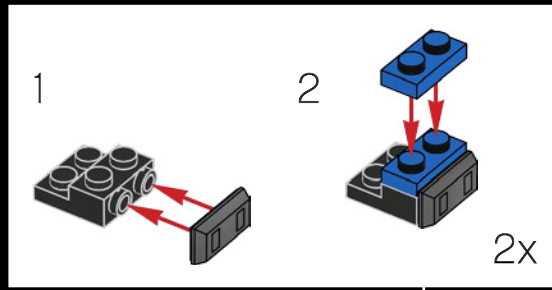

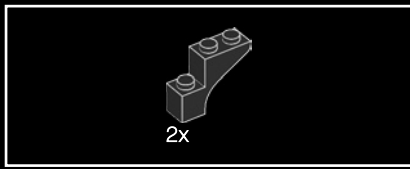

520

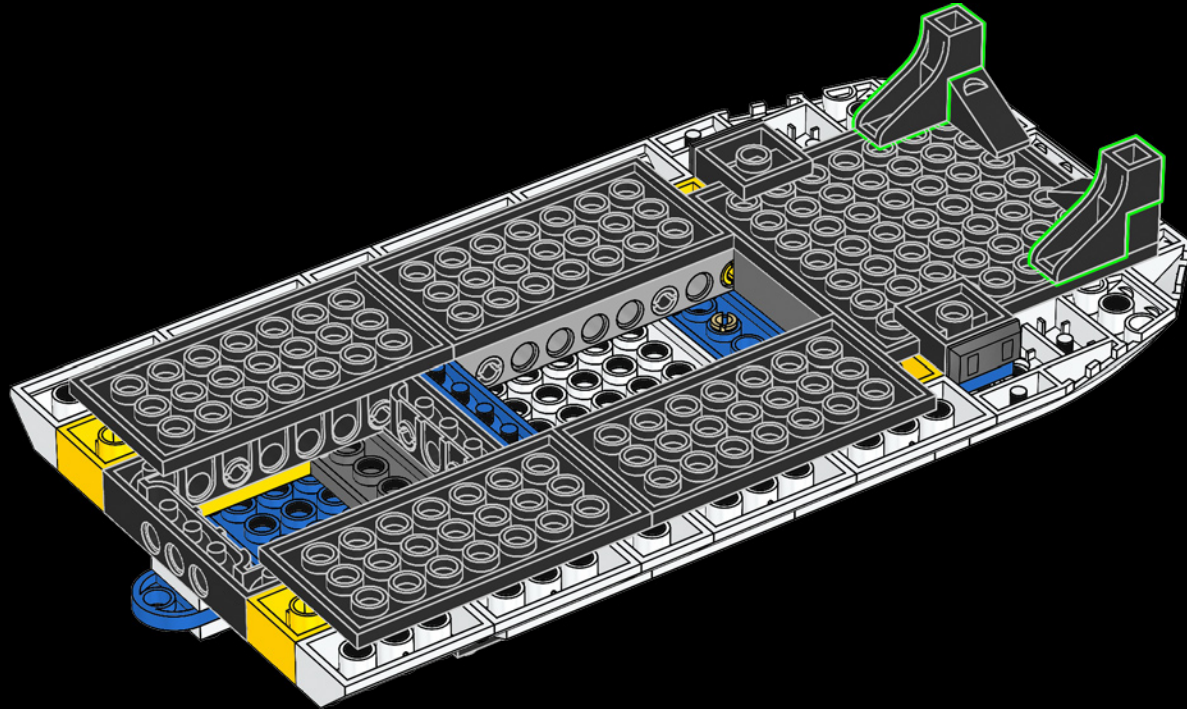

521

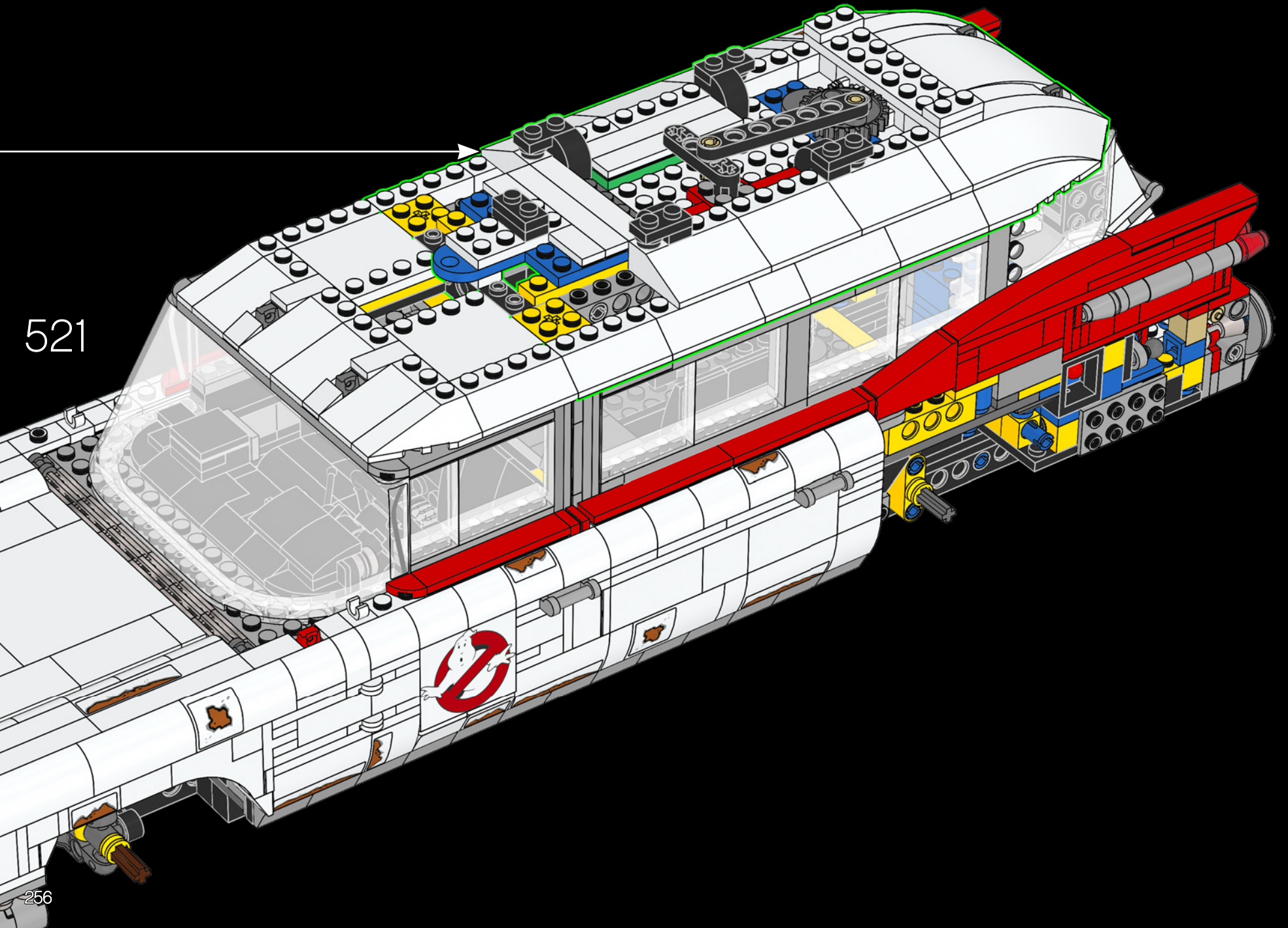



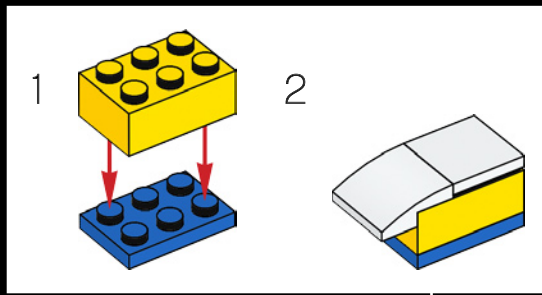
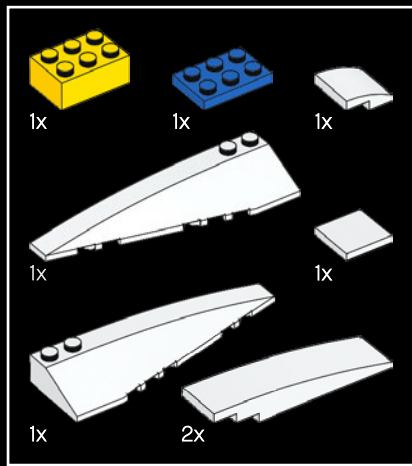

522

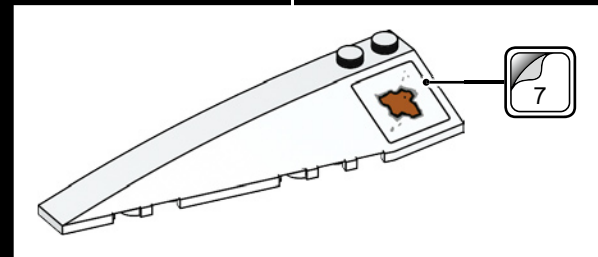
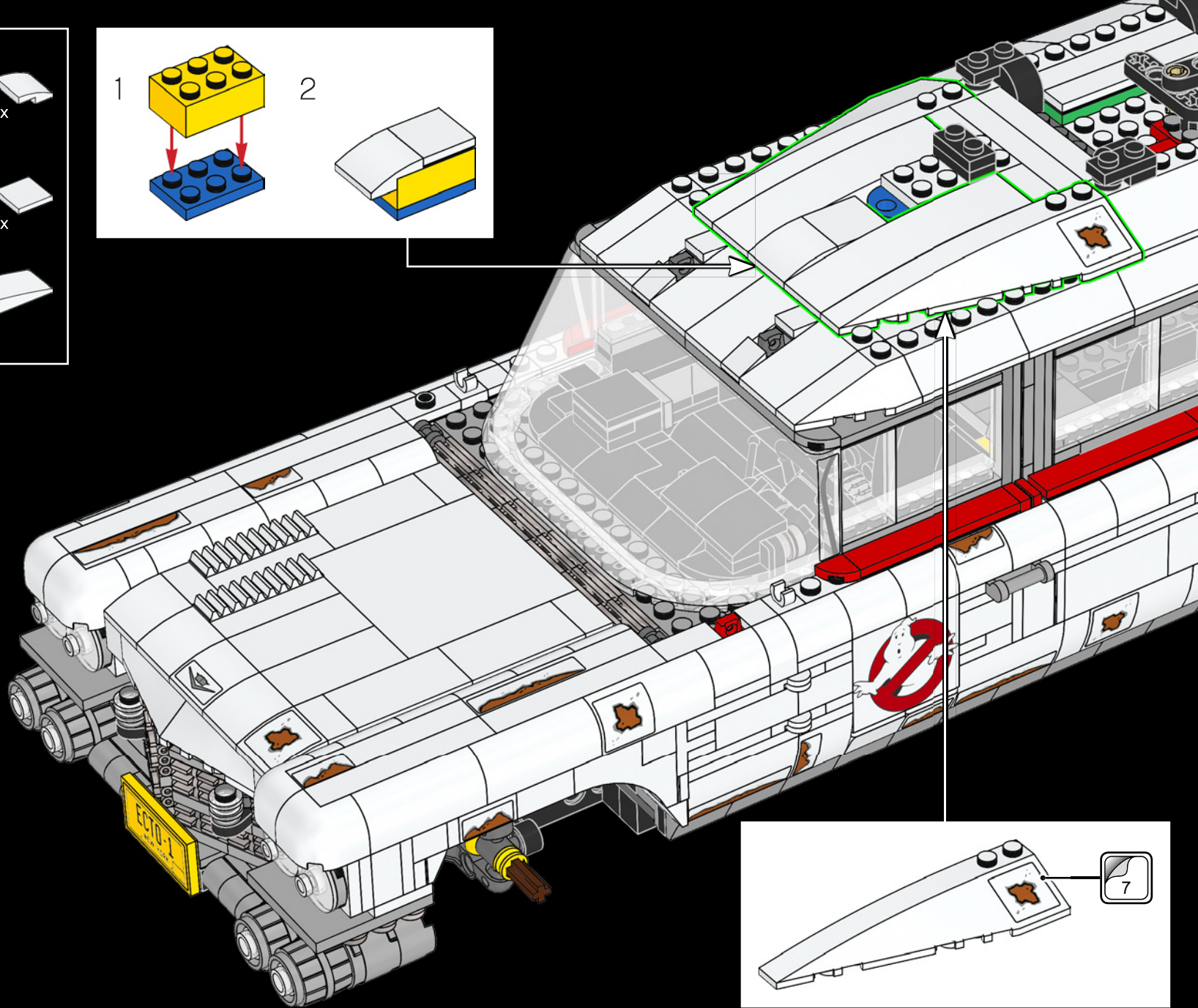

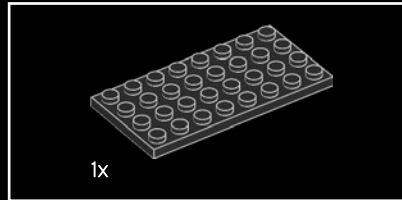
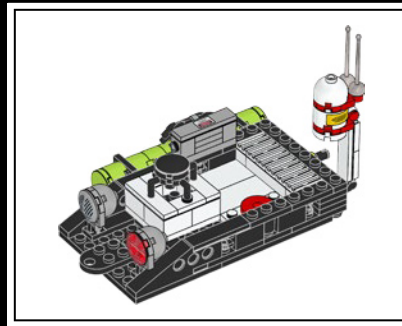
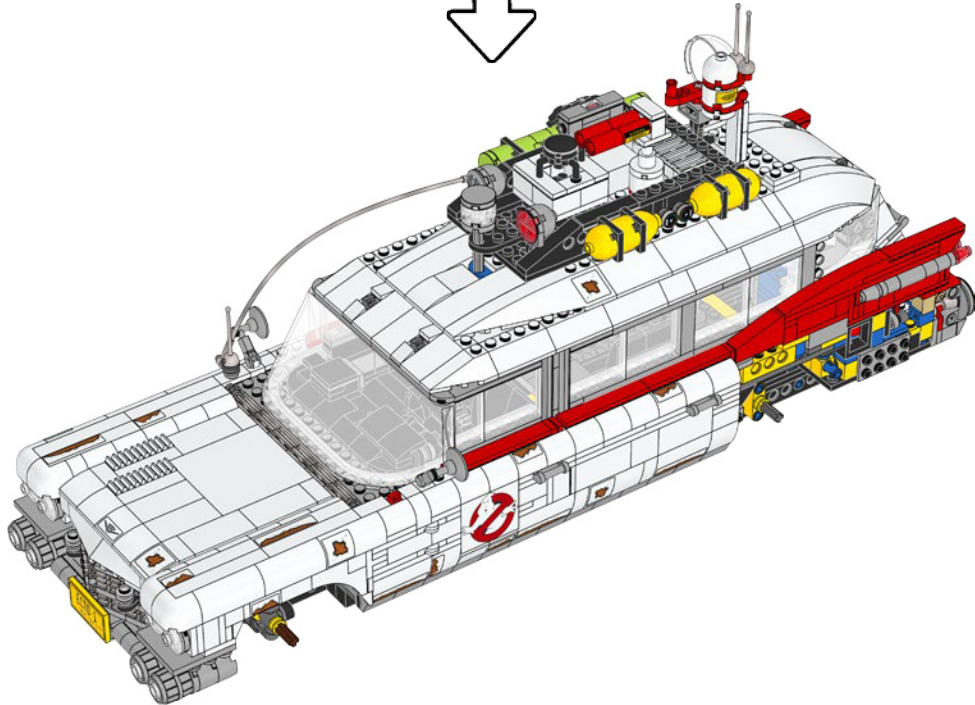
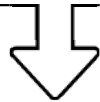

523

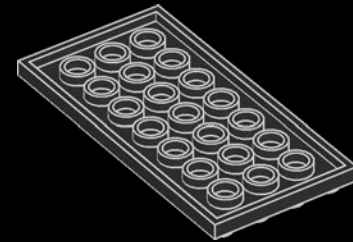

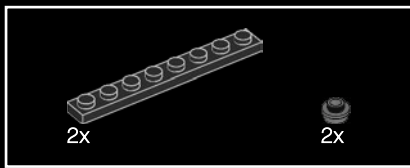

524

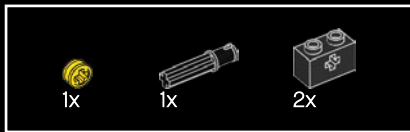
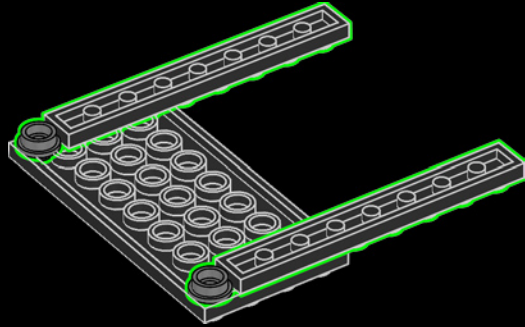

525

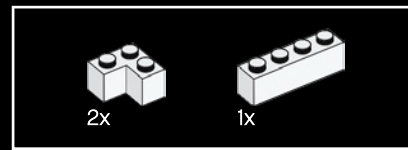
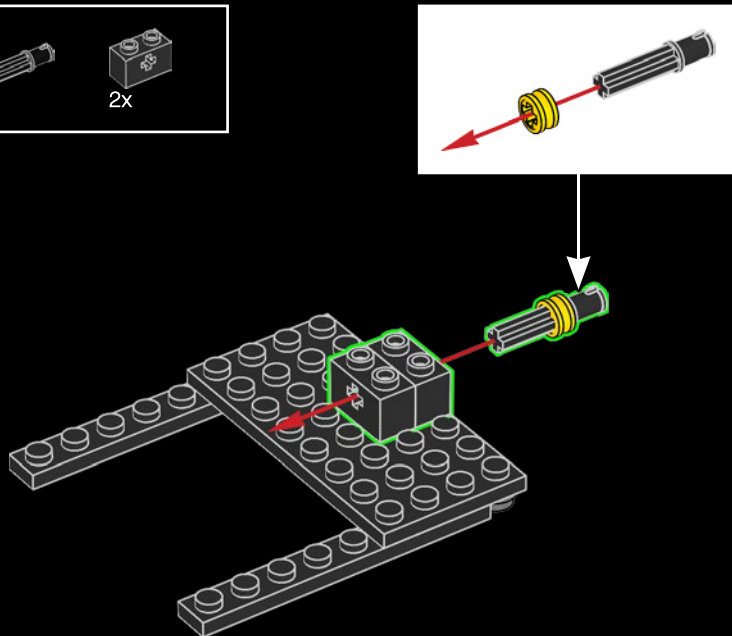

526

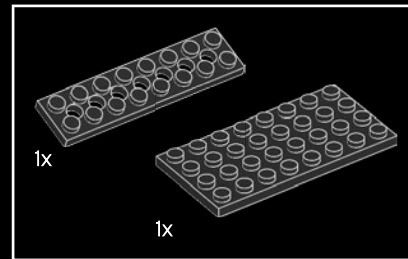
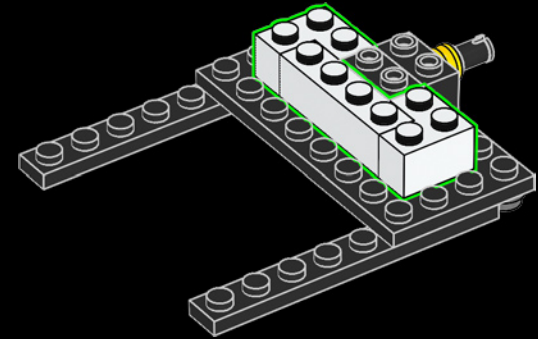

527

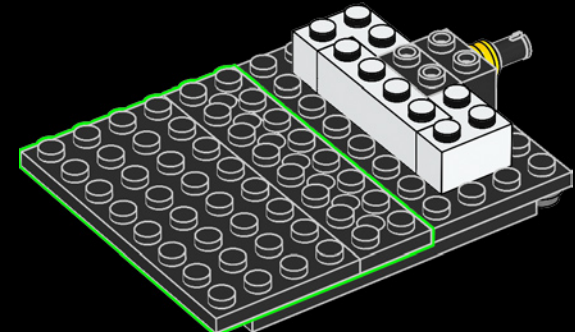

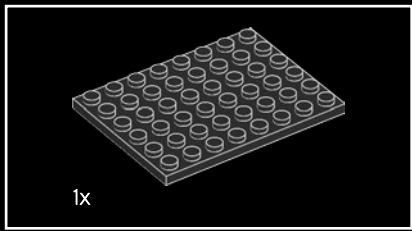

528

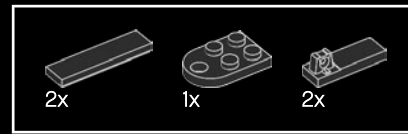
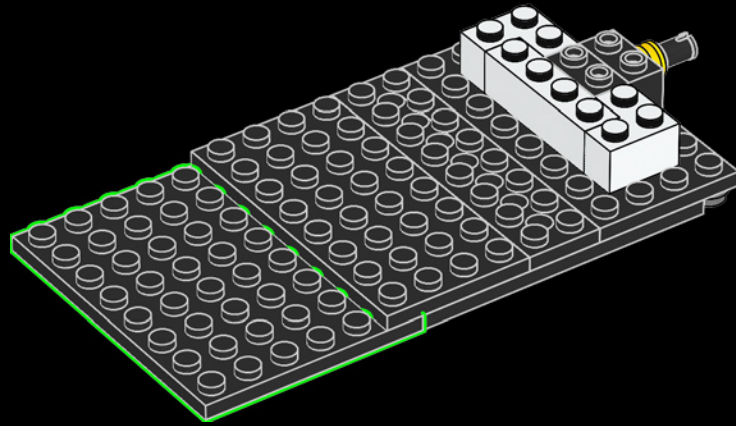

529

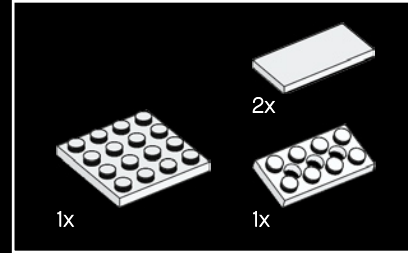
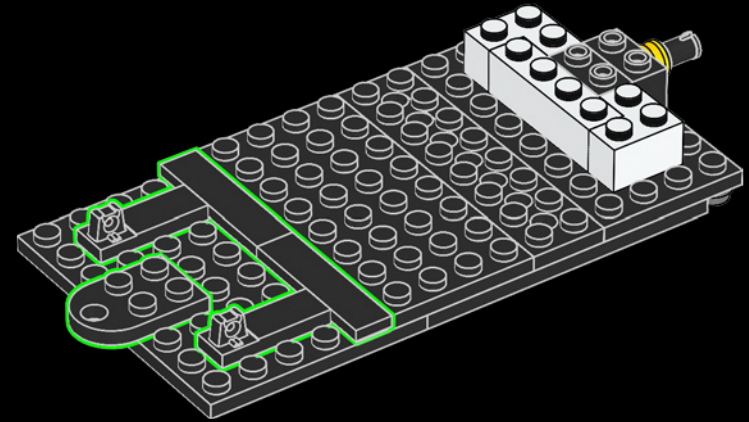

530

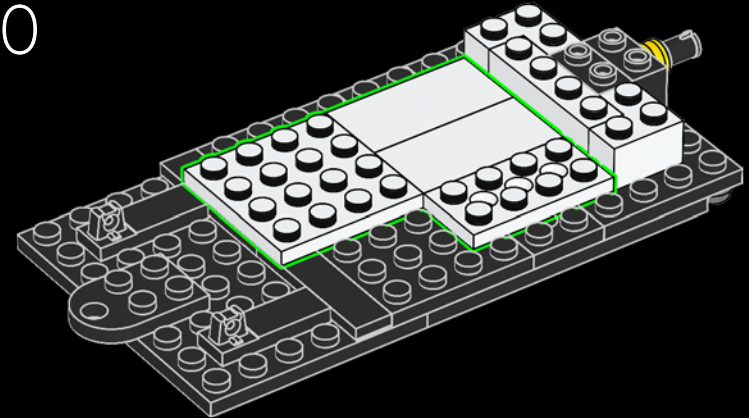

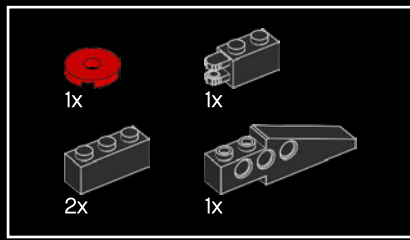

531

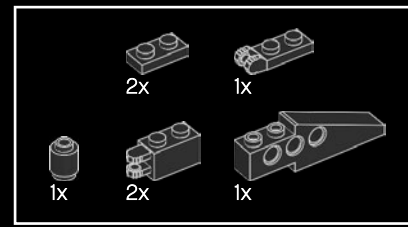
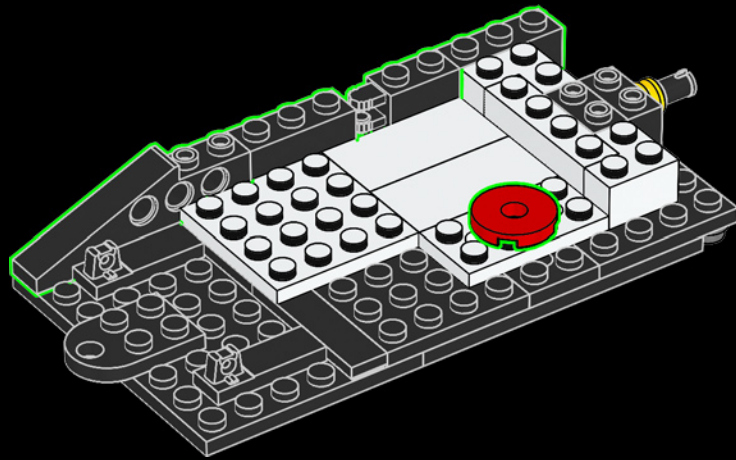

532

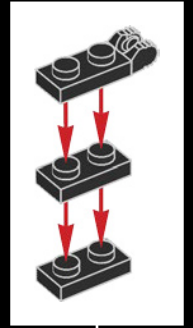
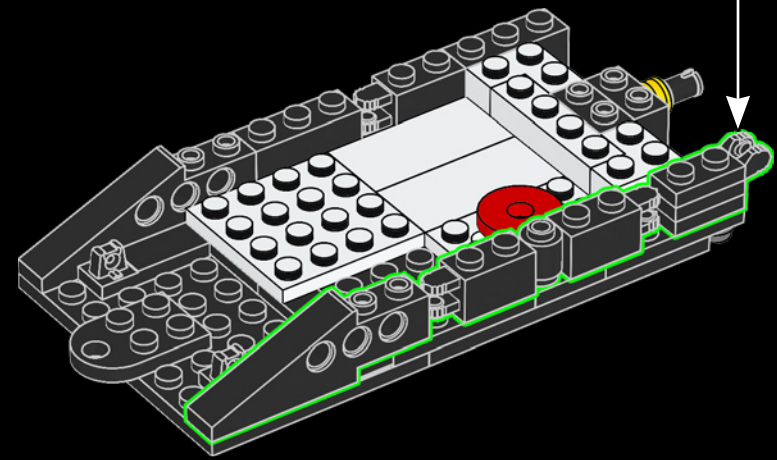

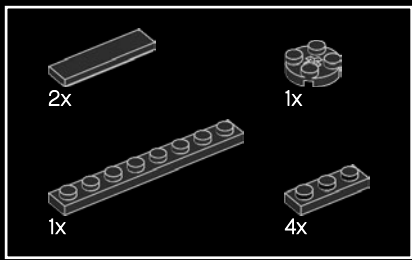

533

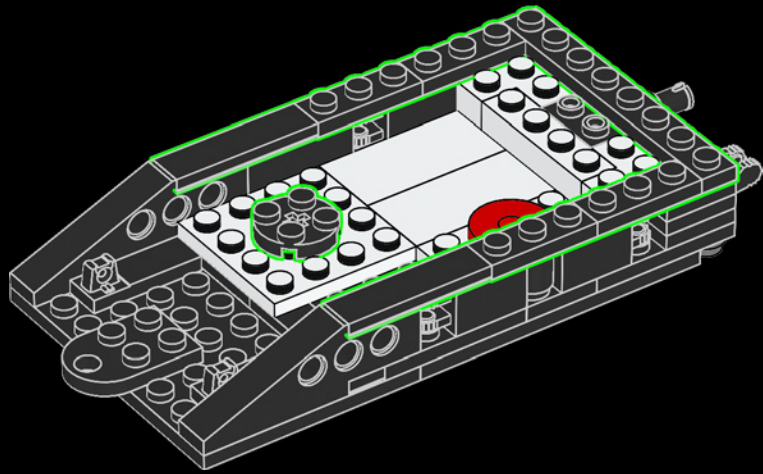

534

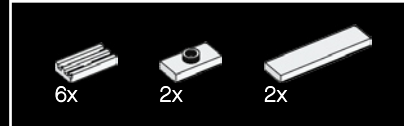
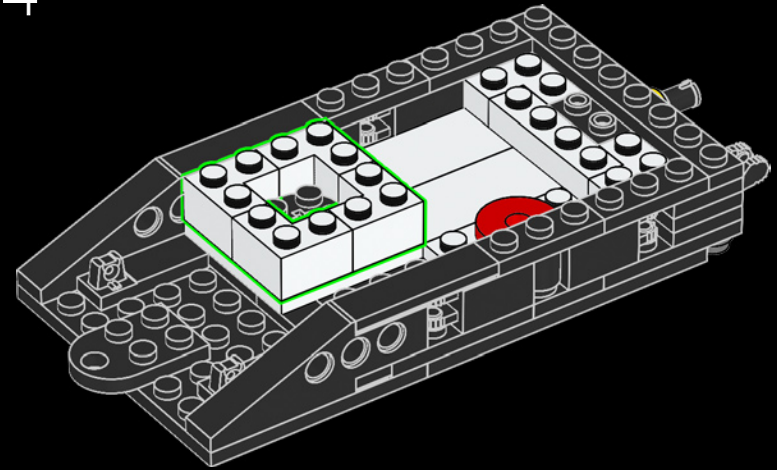

535

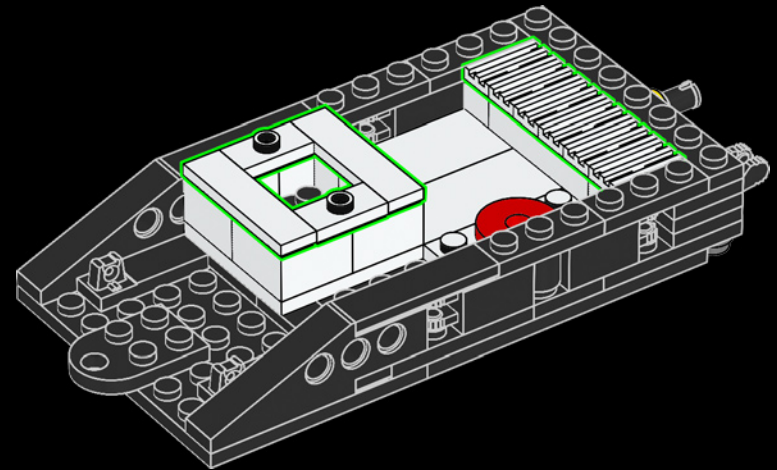

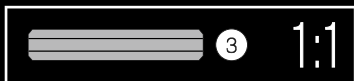
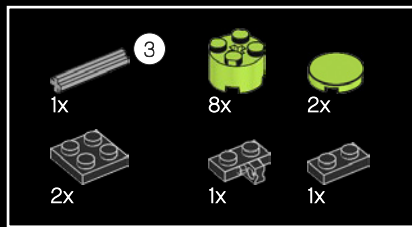

536

1



2

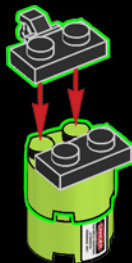

3

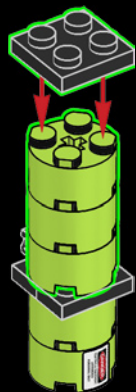

4

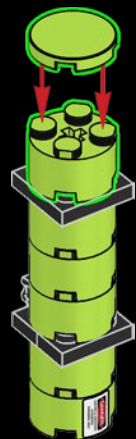

5

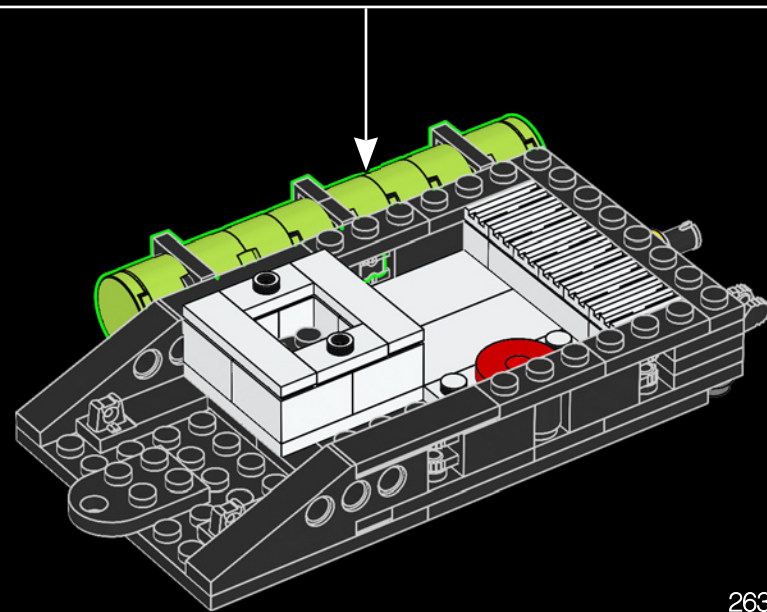
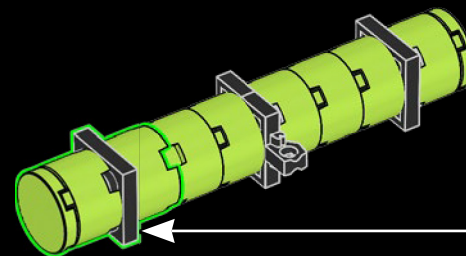
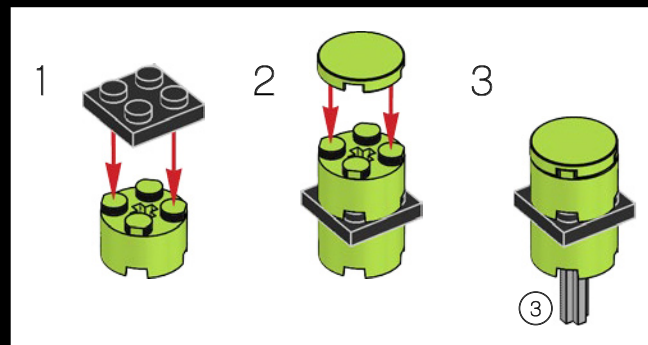

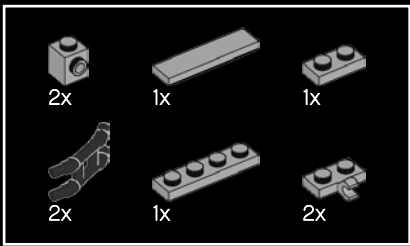

537

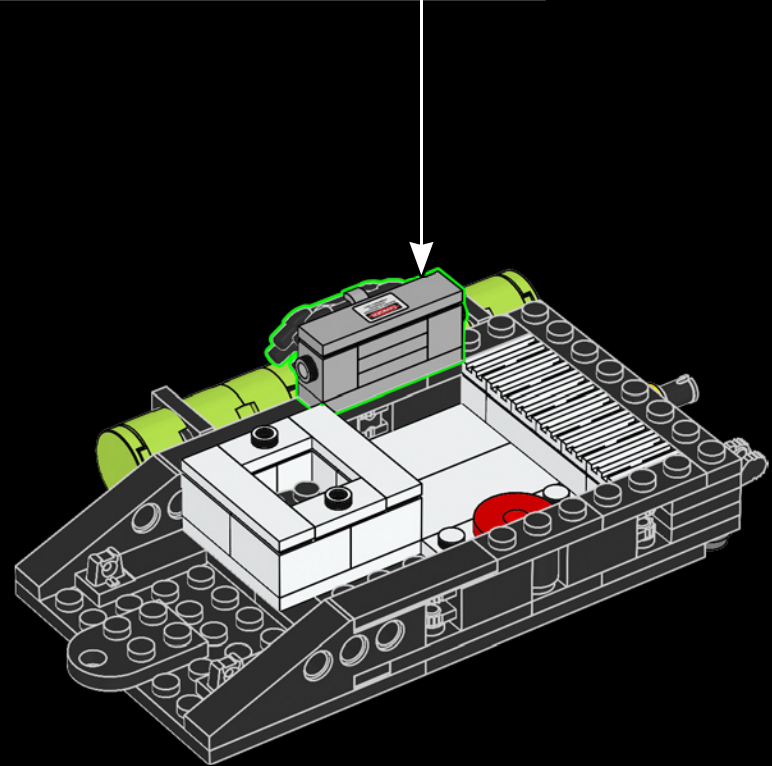
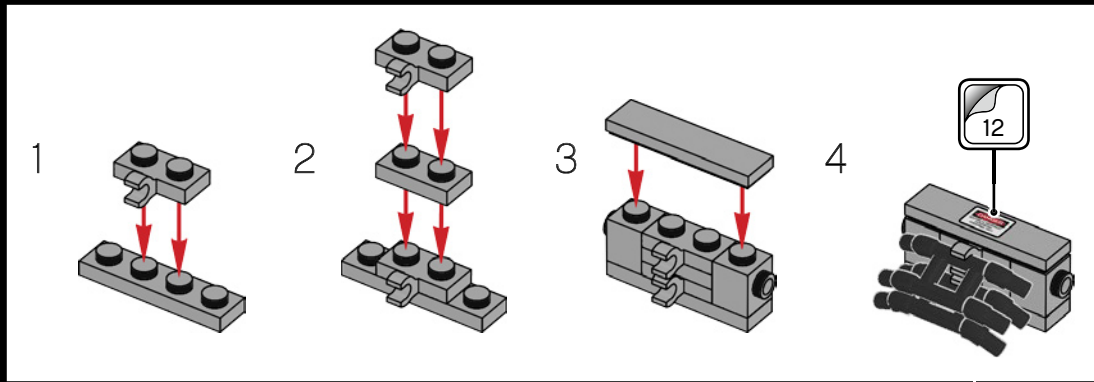





538

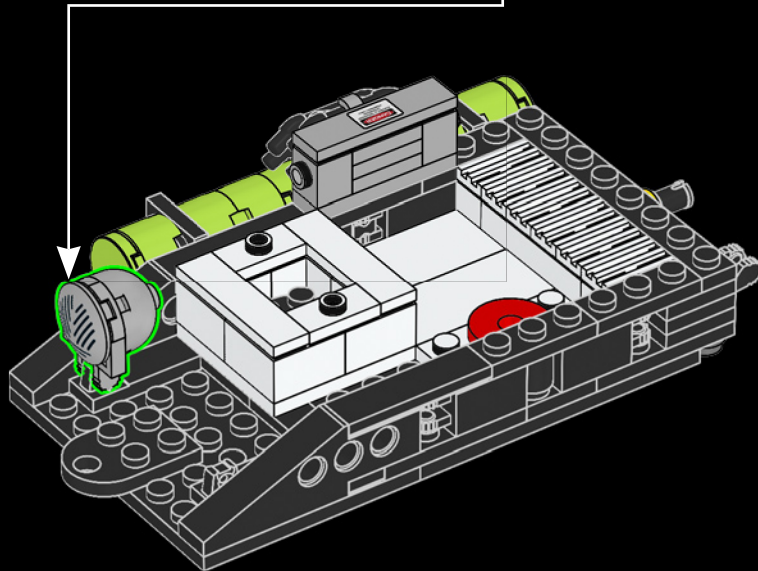
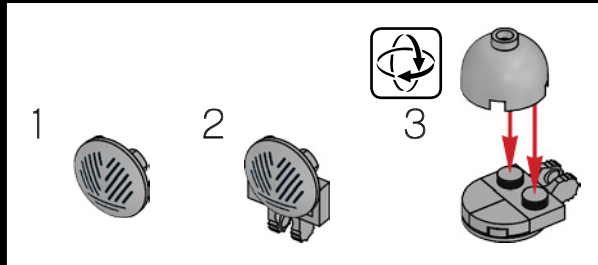

The pitch of this FEDERAL SIREN has been modified to set it apart from other emergency vehicles in New York.  
 La fréquence de cette SIRÈNE FEDERAL a été modifiée pour la distinguer des autres véhicules d'urgence à New York.  
 El tono de esta SIRENA FEDERAL se modificó para distinguirlo del resto de los vehículos de emergencias de Nueva York.



539

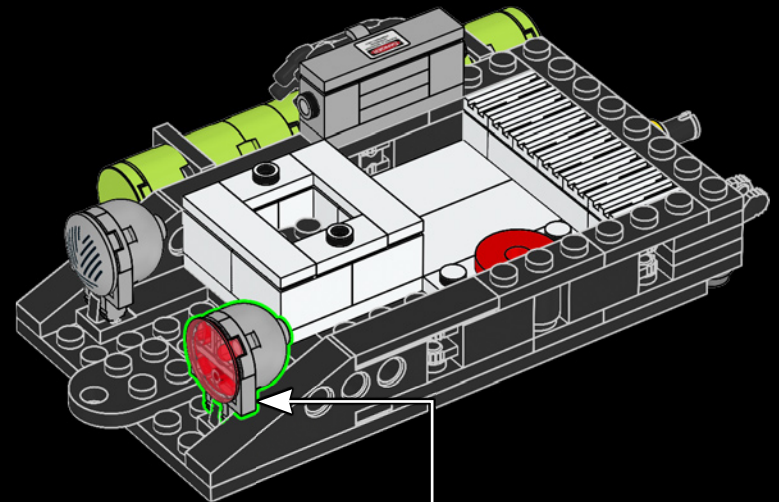

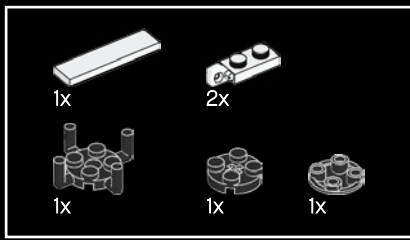

540

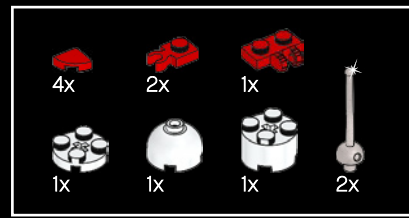
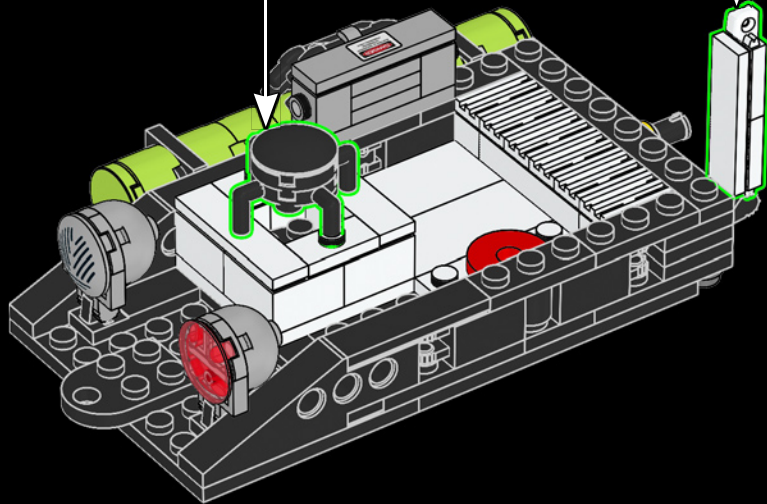
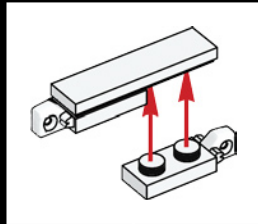
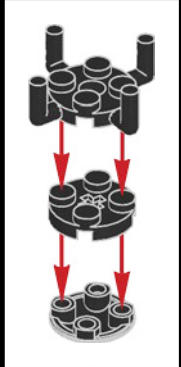

541

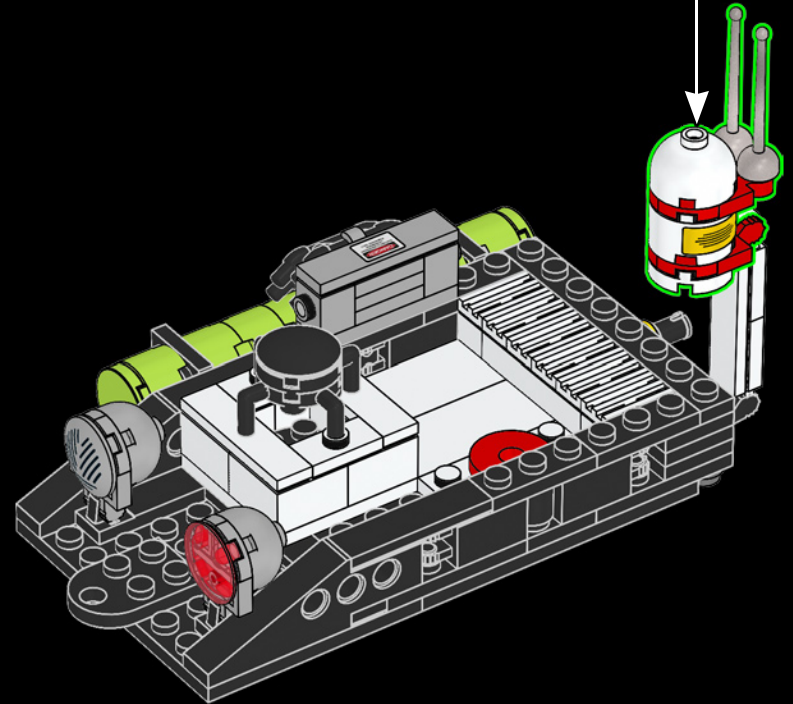
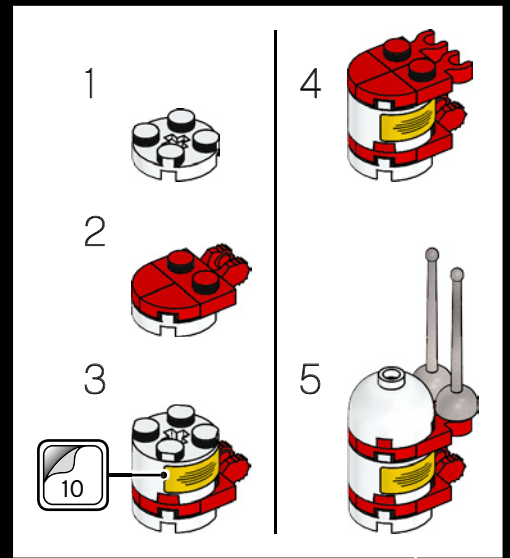



The MODIFIED MARINE RADOME ANTENNA sends out a sonar-like sweep to detect spectral particles.

L'ANTENNE RADÔME MARINE MODIFIÉE envoie un balayage en sonar pour détecter les particules spectrales.

La ANTENA RADOMO MARINA MODIFICADA hace barridos como un sonar para detectar partículas espectrales.

542

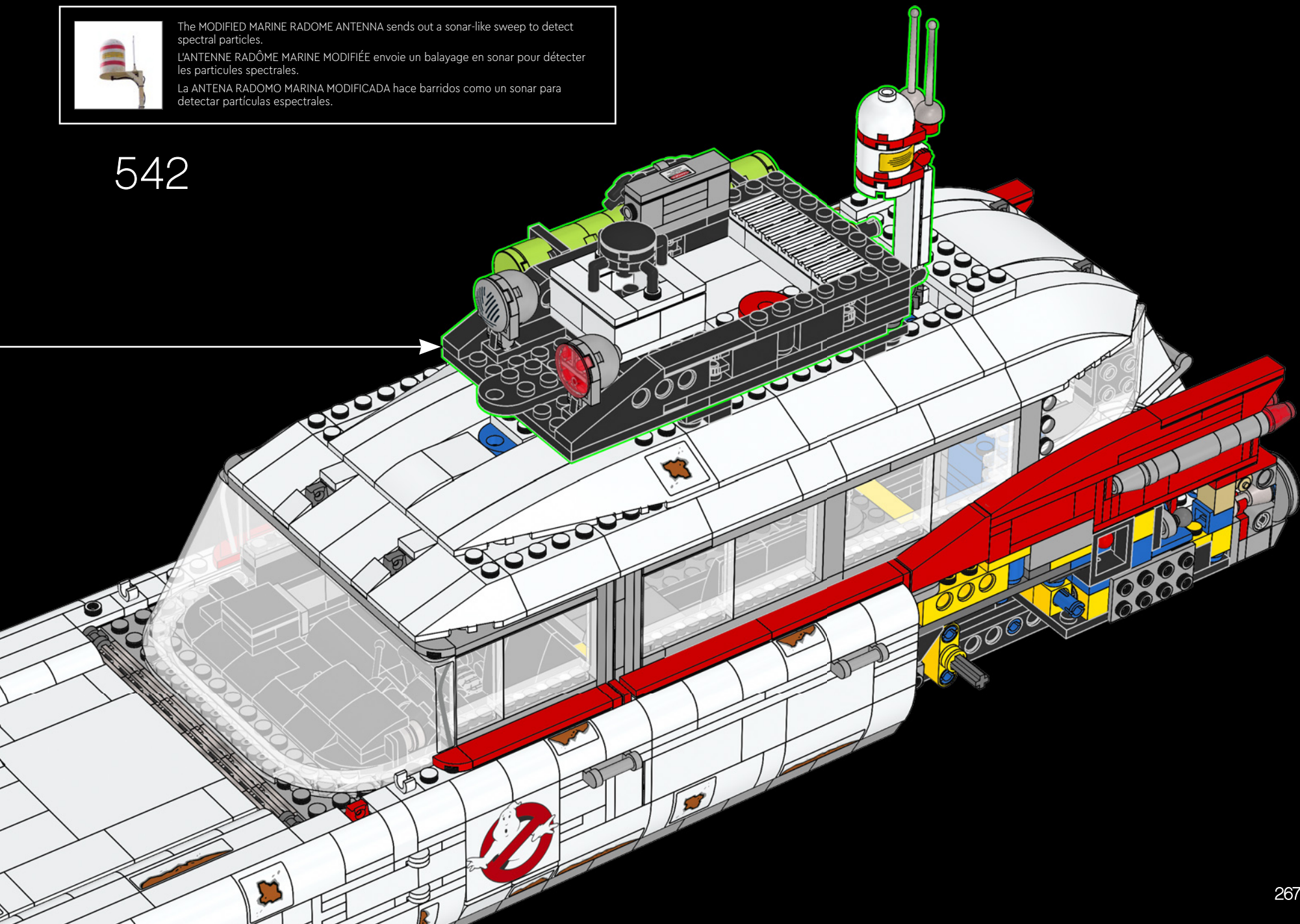

543

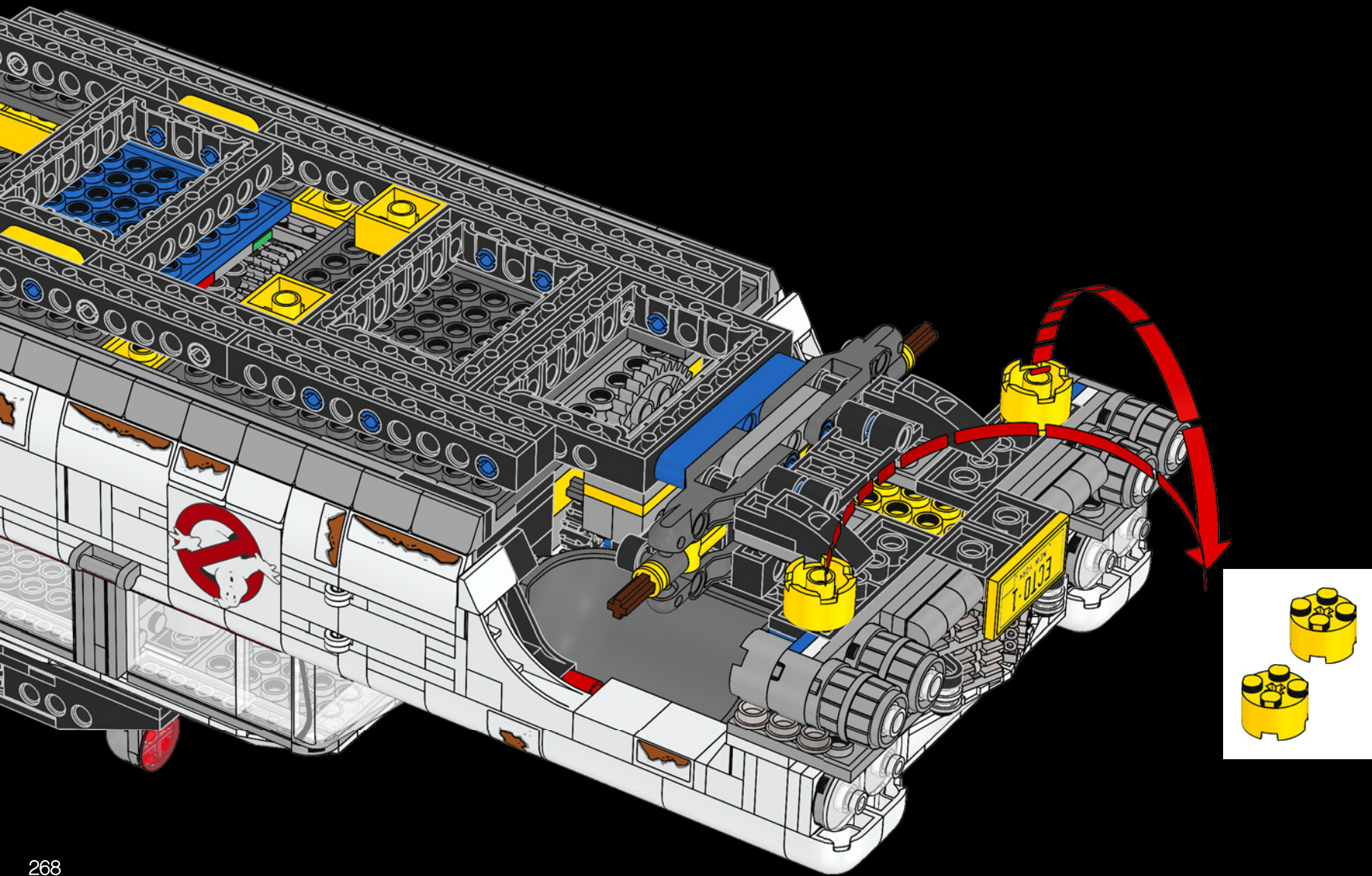

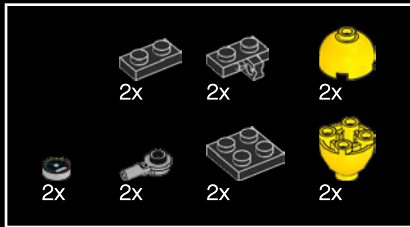

544

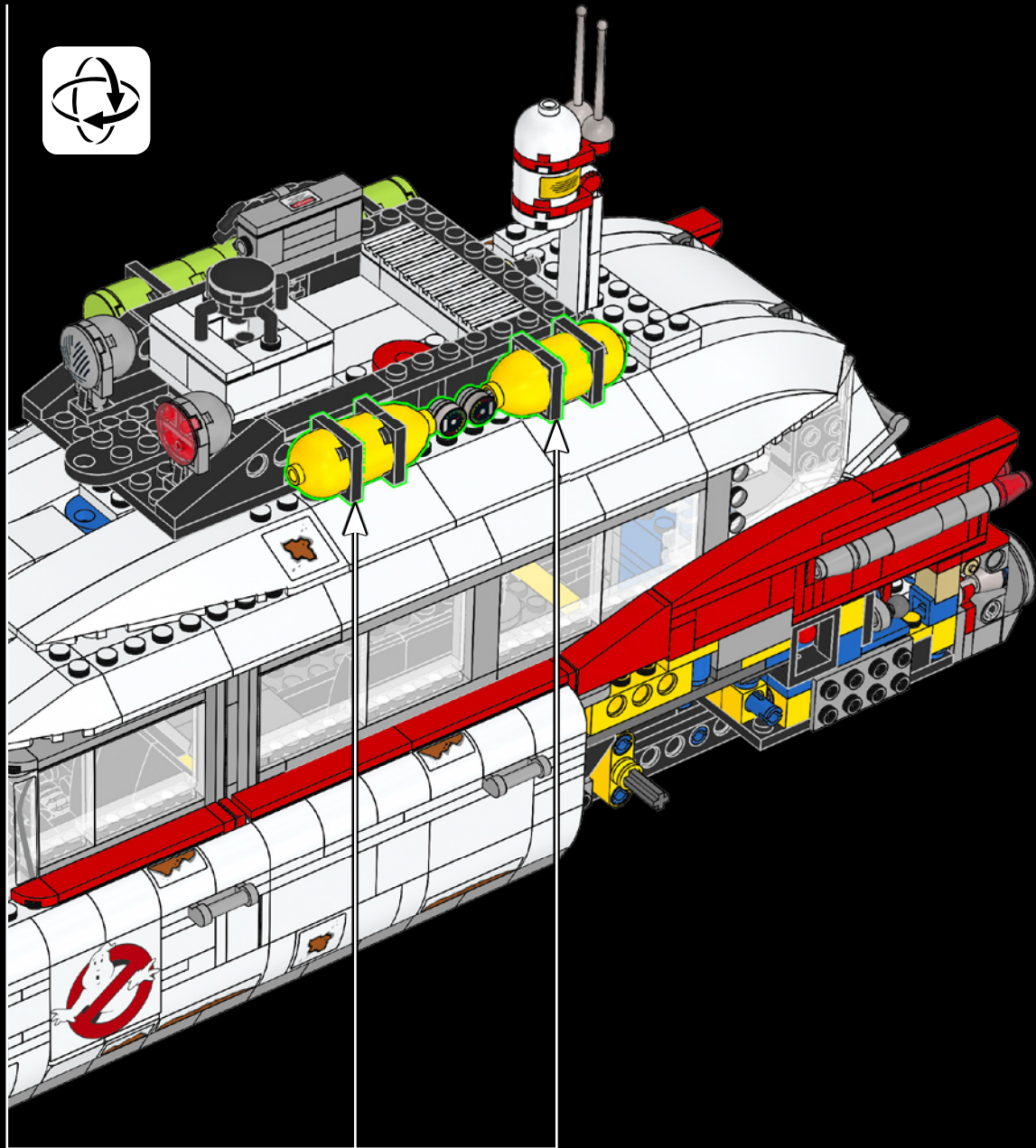
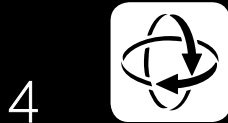
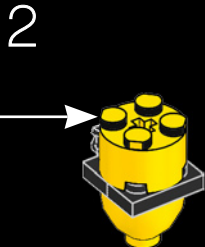
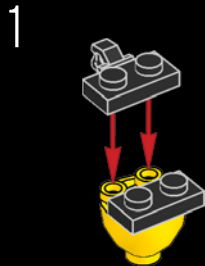





546

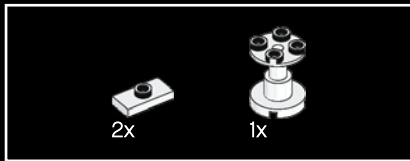
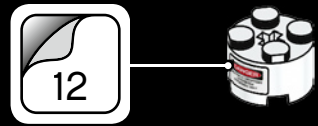

547

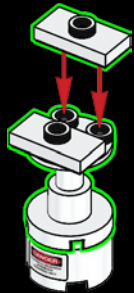

548

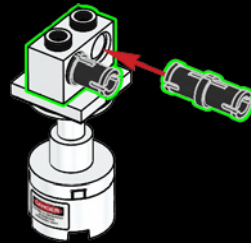

549

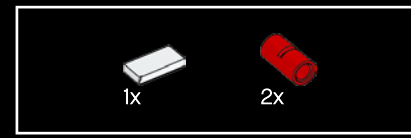
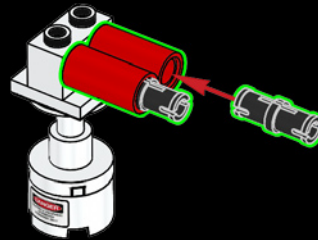

550

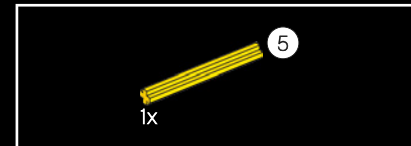
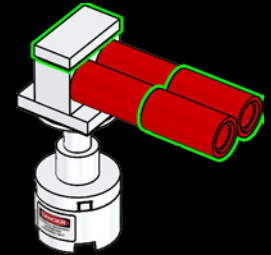

551

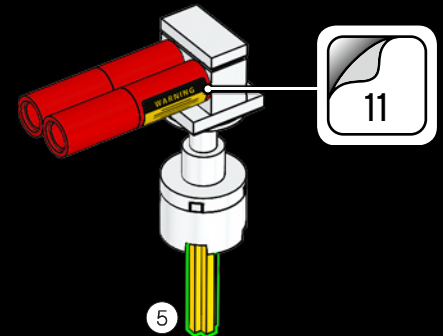



The T.U. ANTENNA, better known as the "SNIFFER", monitors psychokinetic energy.

L'ANTENNE T.U., mieux connue sous le nom de « DÉTECTEUR », capte l'énergie psychokinétique.

La ANTENA T. U., un dispositivo de detección formado por dos barras que sobresalen, registra la energía psicokinética.

552

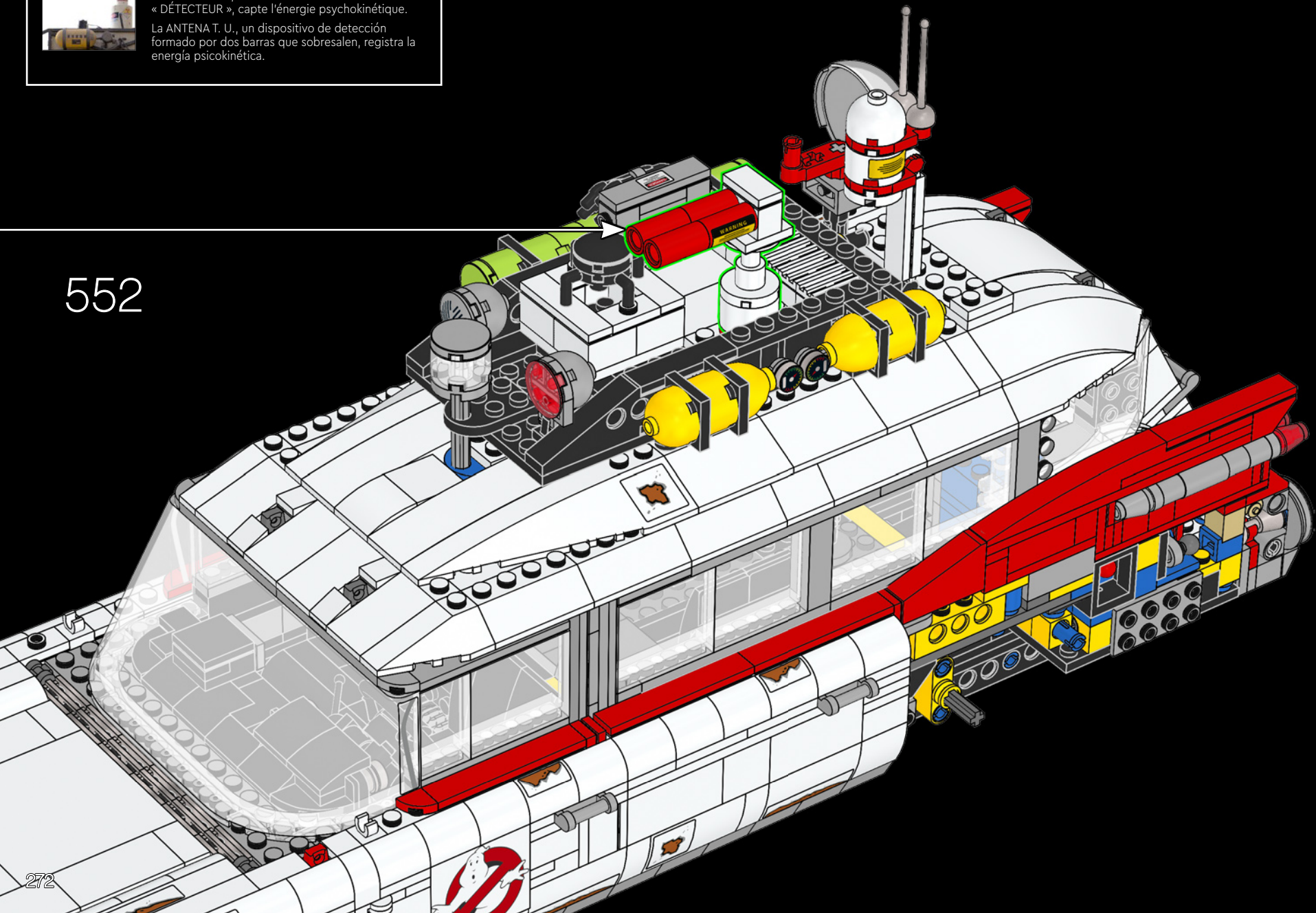



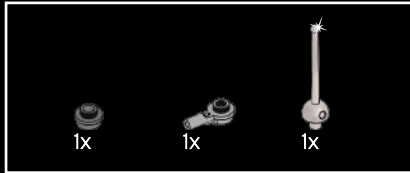
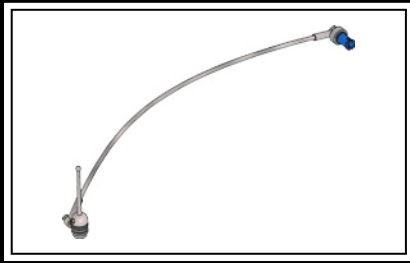

553

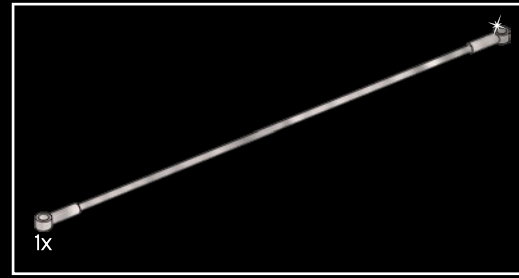

554

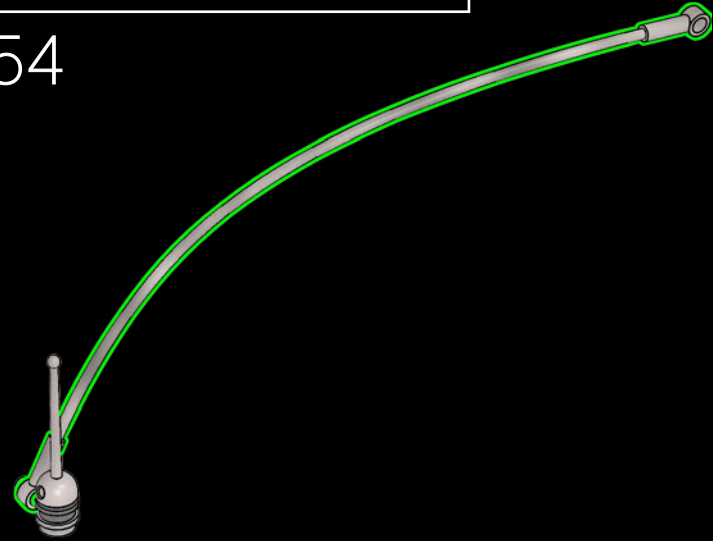

555

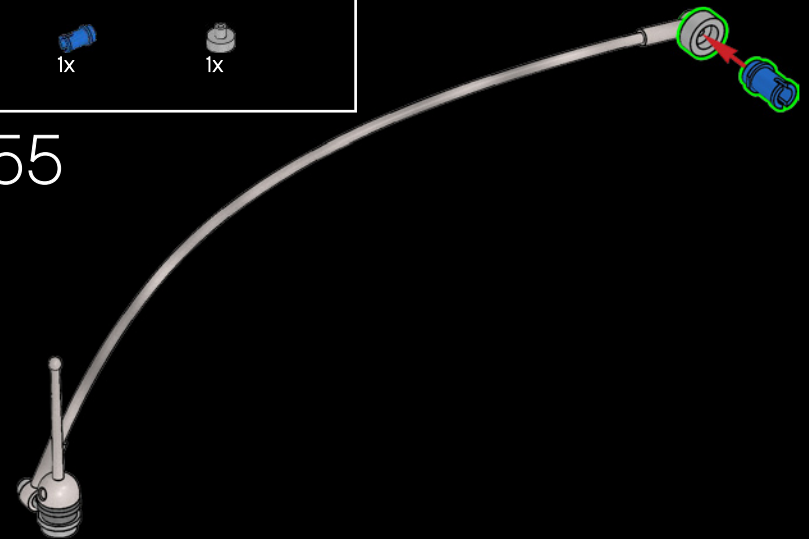



556

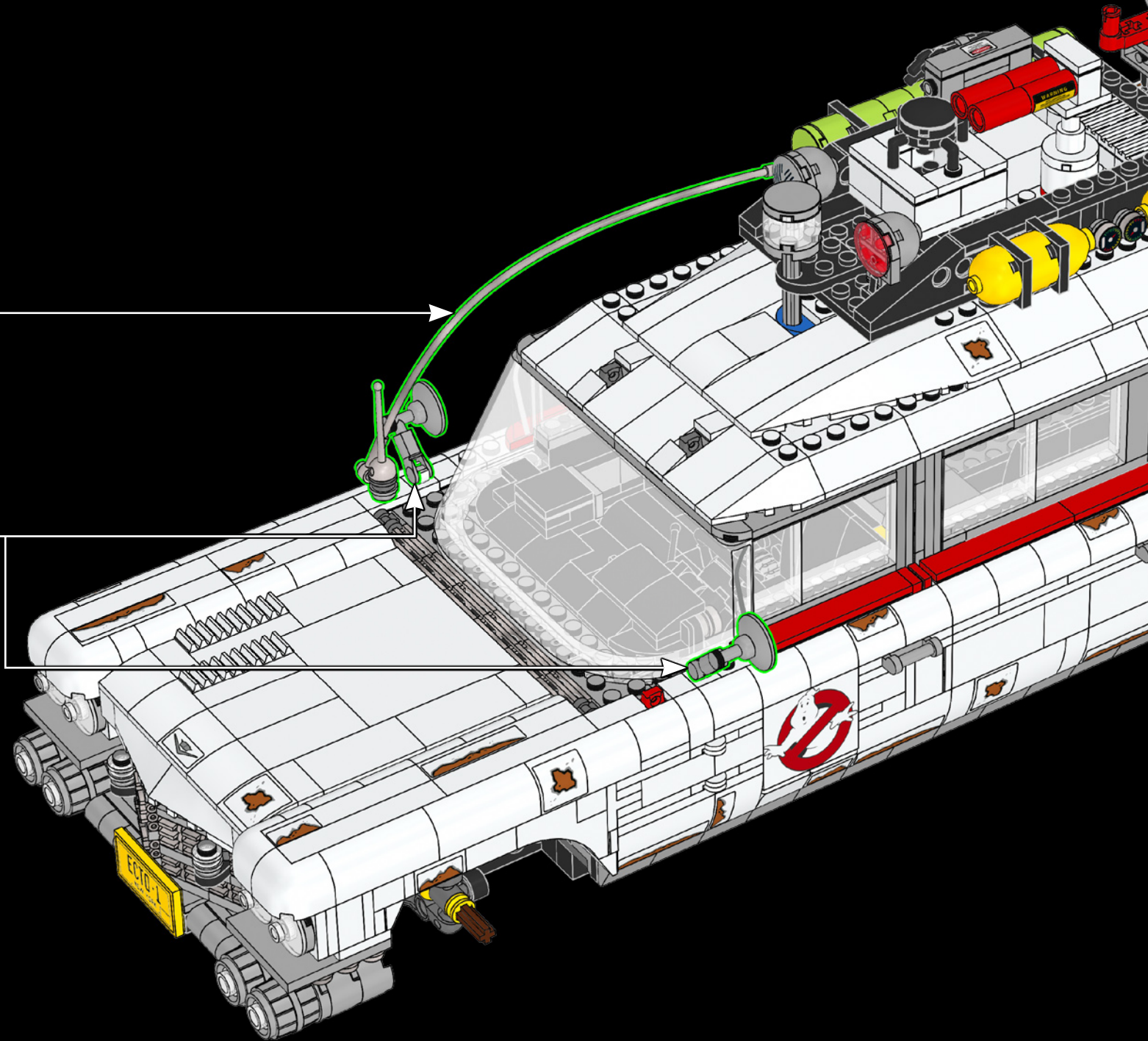
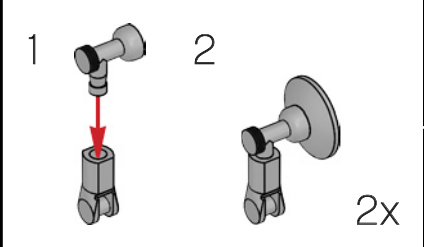

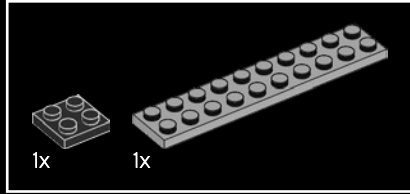
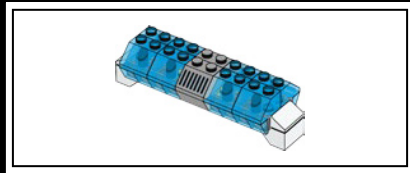
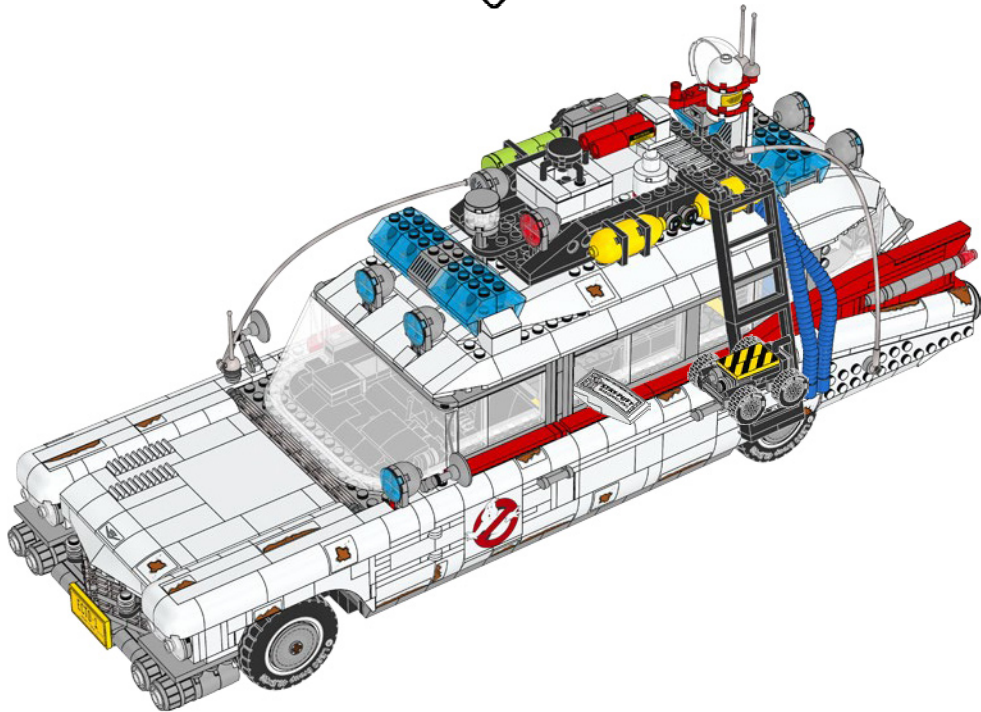
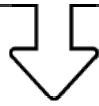

557

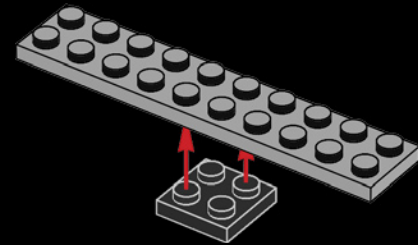



558

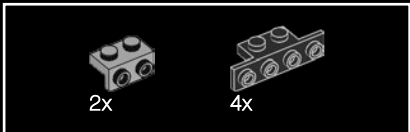
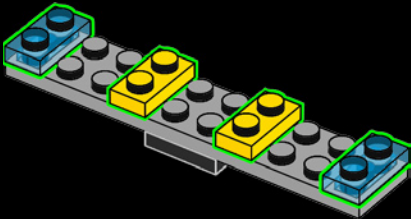

559

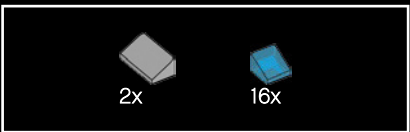
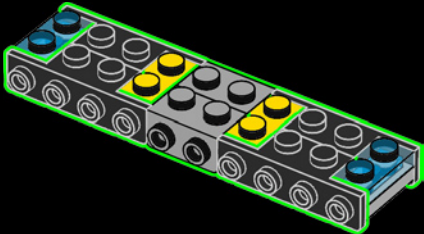

560

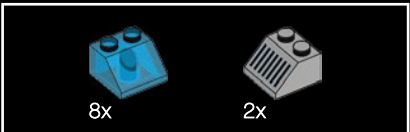
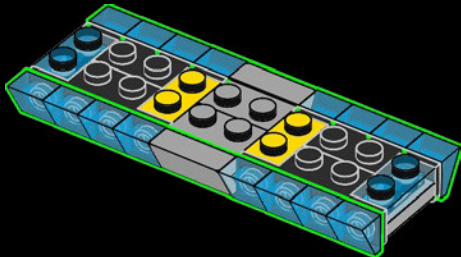

561

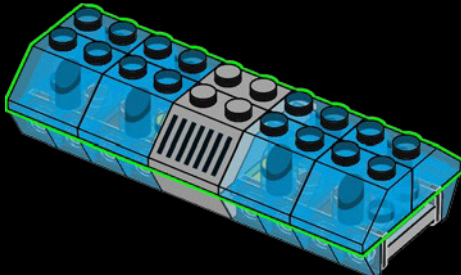

562

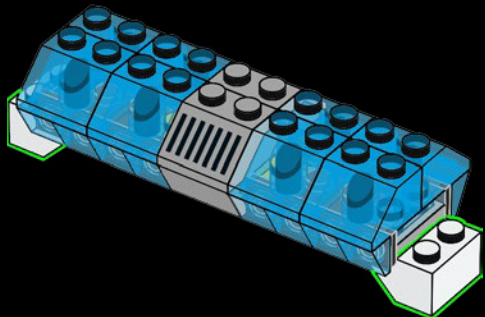

563

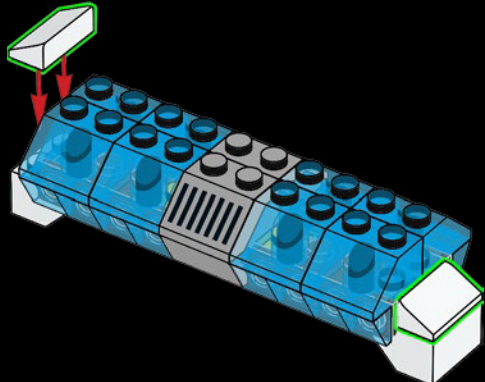

564

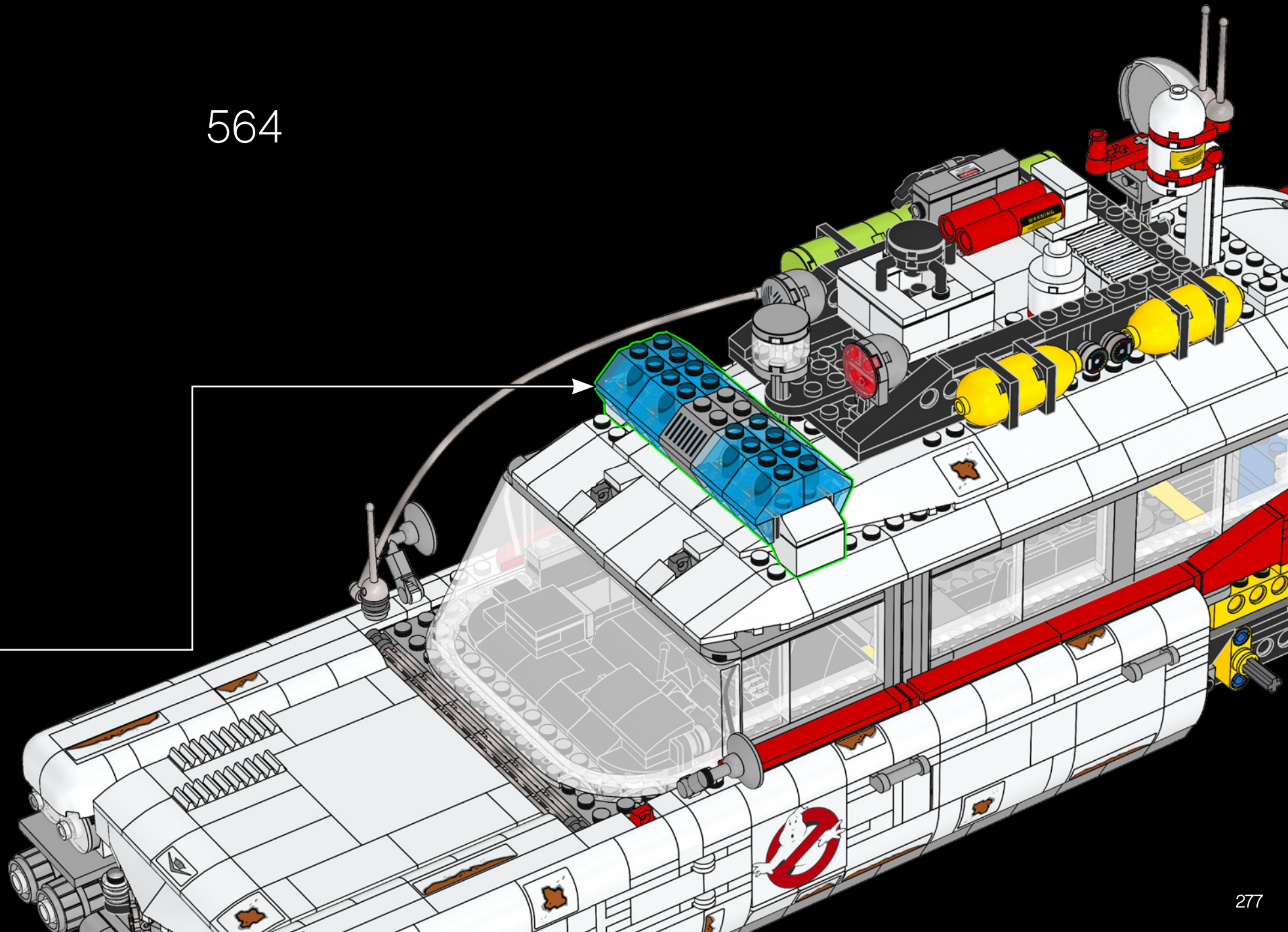



# 565

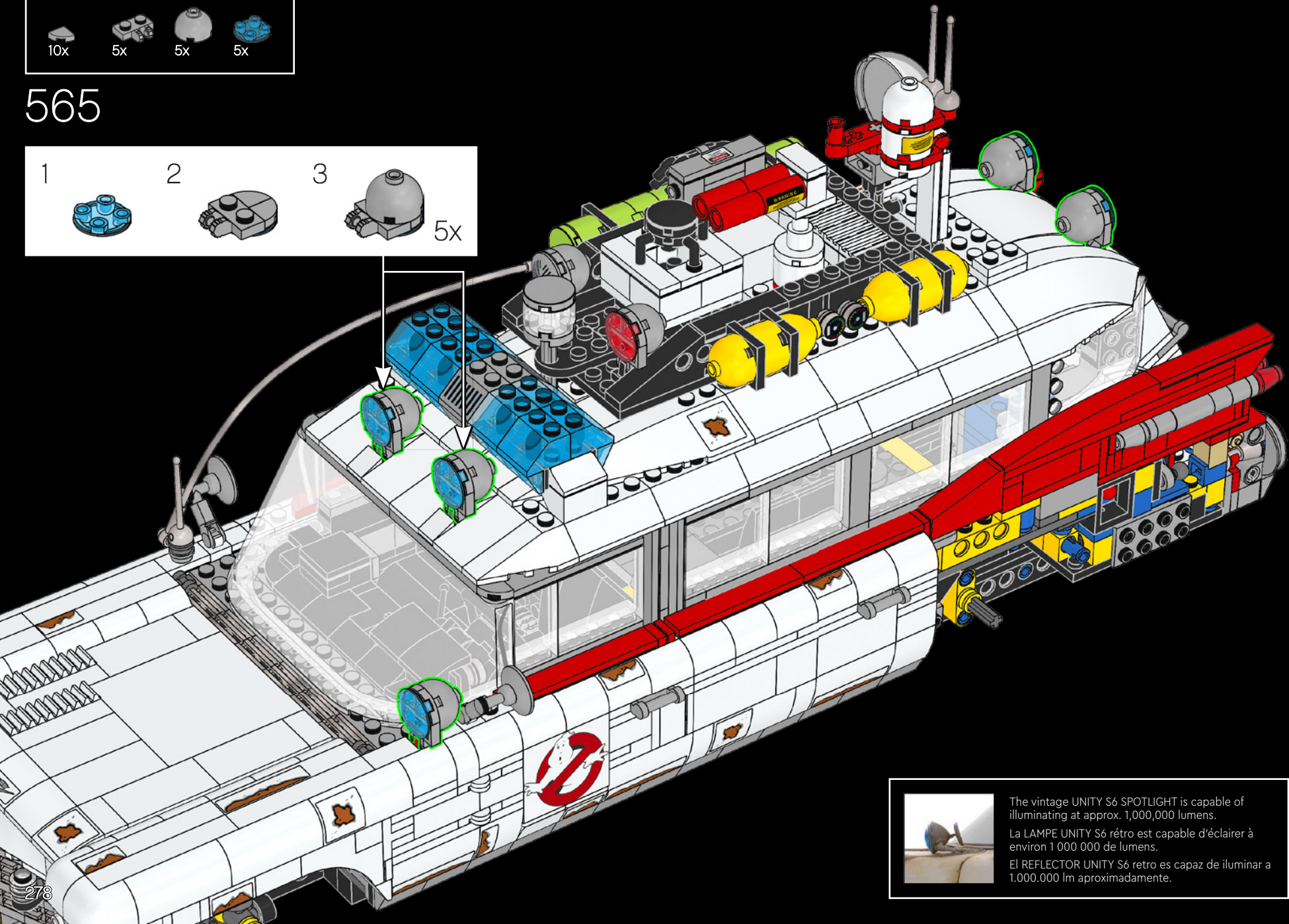
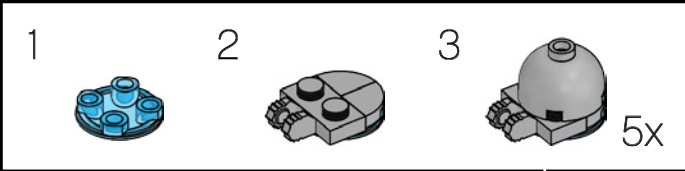

The vintage UNITY S6 SPOTLIGHT is capable of illuminating at approx. 1,000,000 lumens.  
La LAMPE UNITY S6 rétro est capable d'éclairer à environ 1 000 000 de lumens.  
El REFLECTOR UNITY S6 retro es capaz de iluminar a 1.000.000 lm aproximadamente.

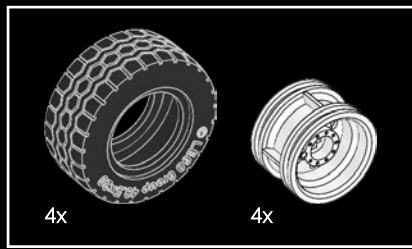

566

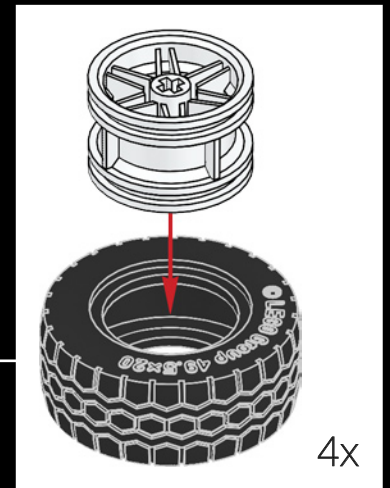
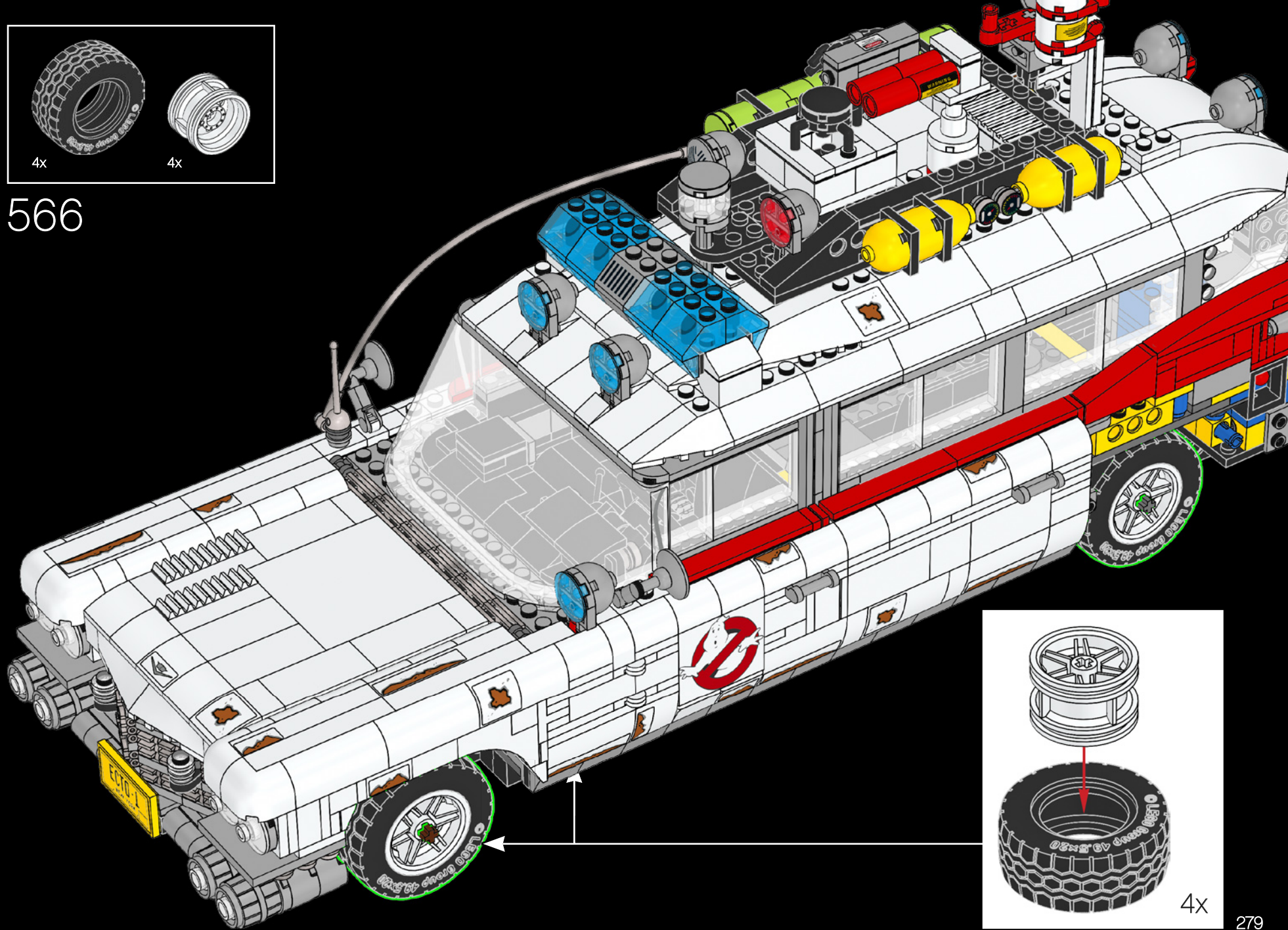

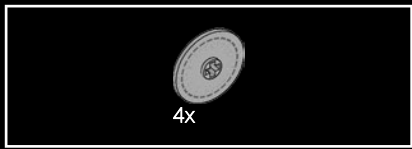

567

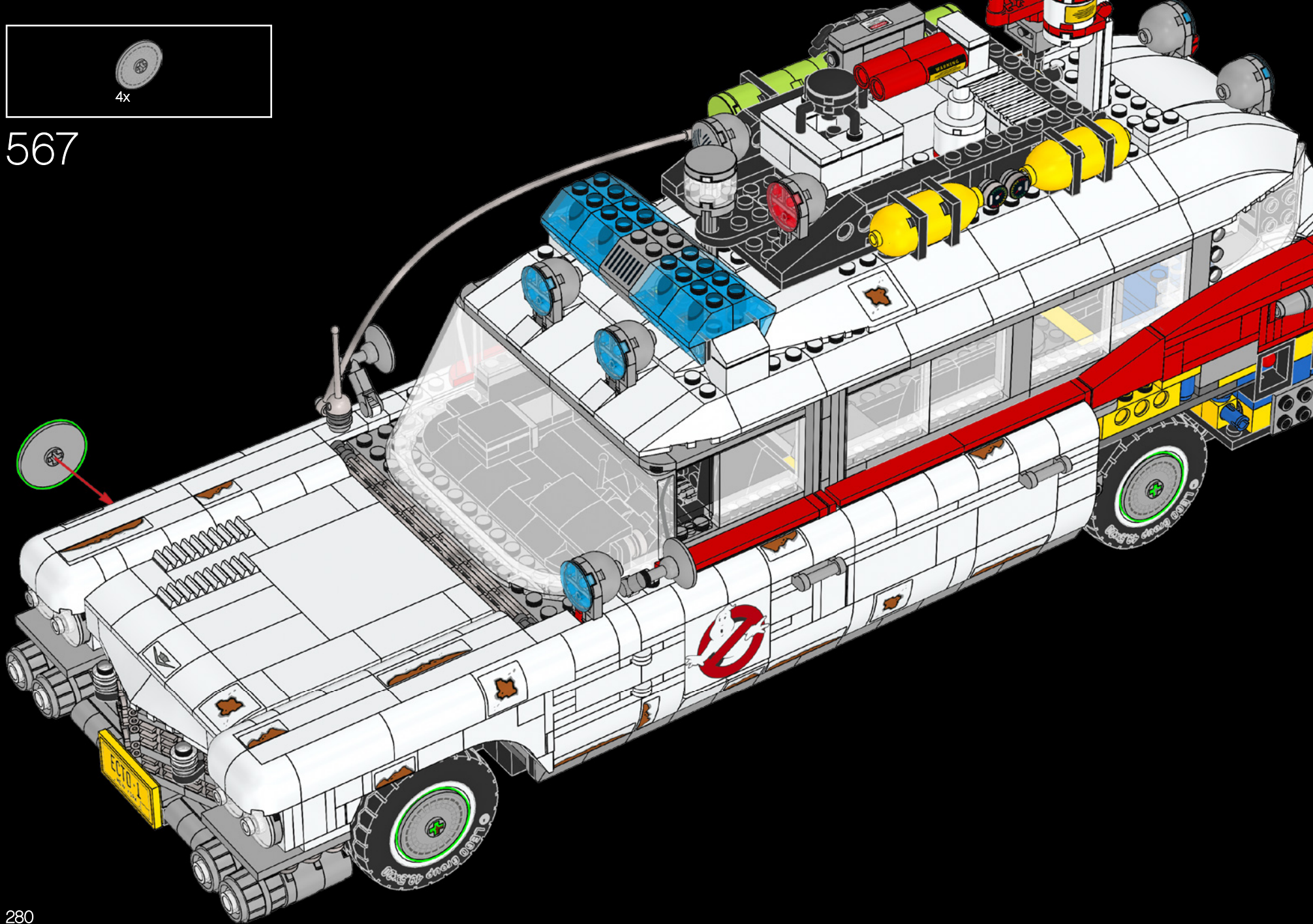



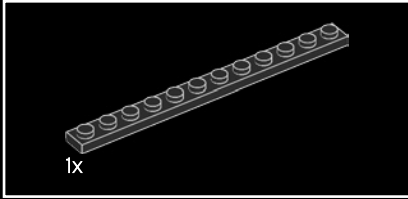
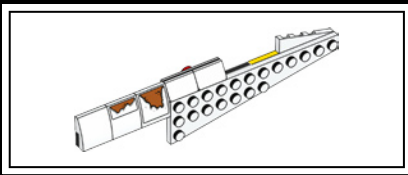

568

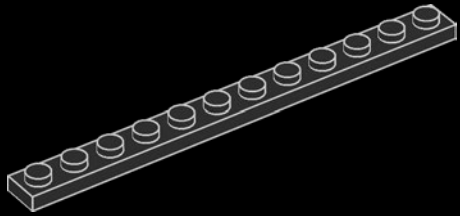

569

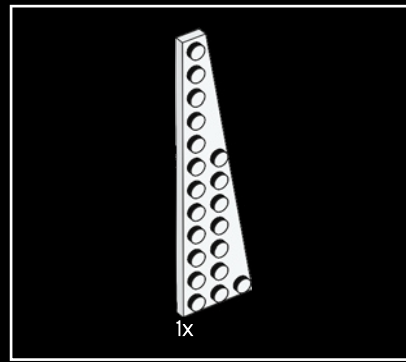
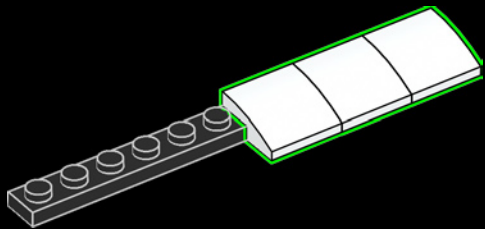

570

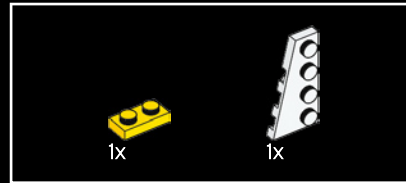
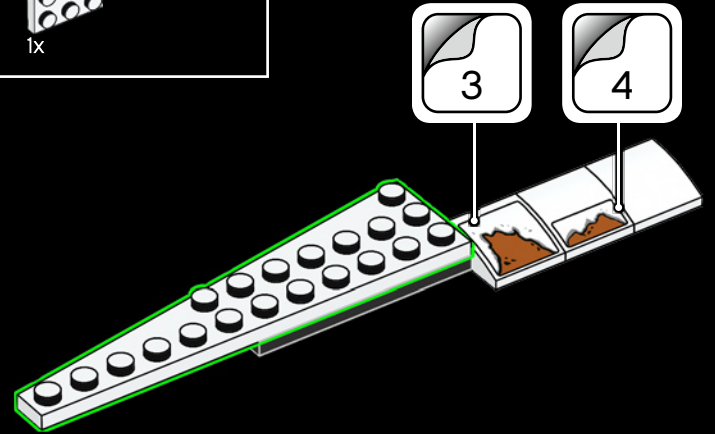

571

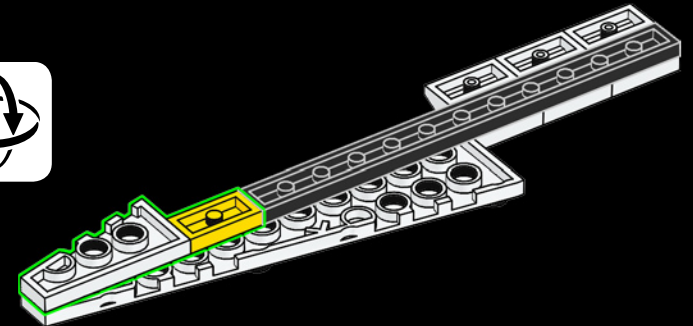



572

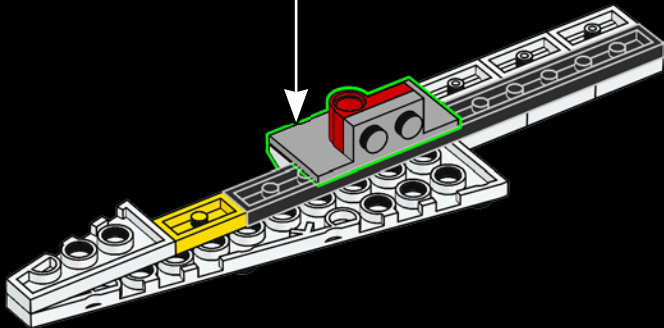
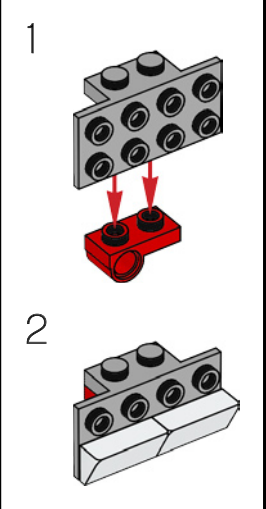

573

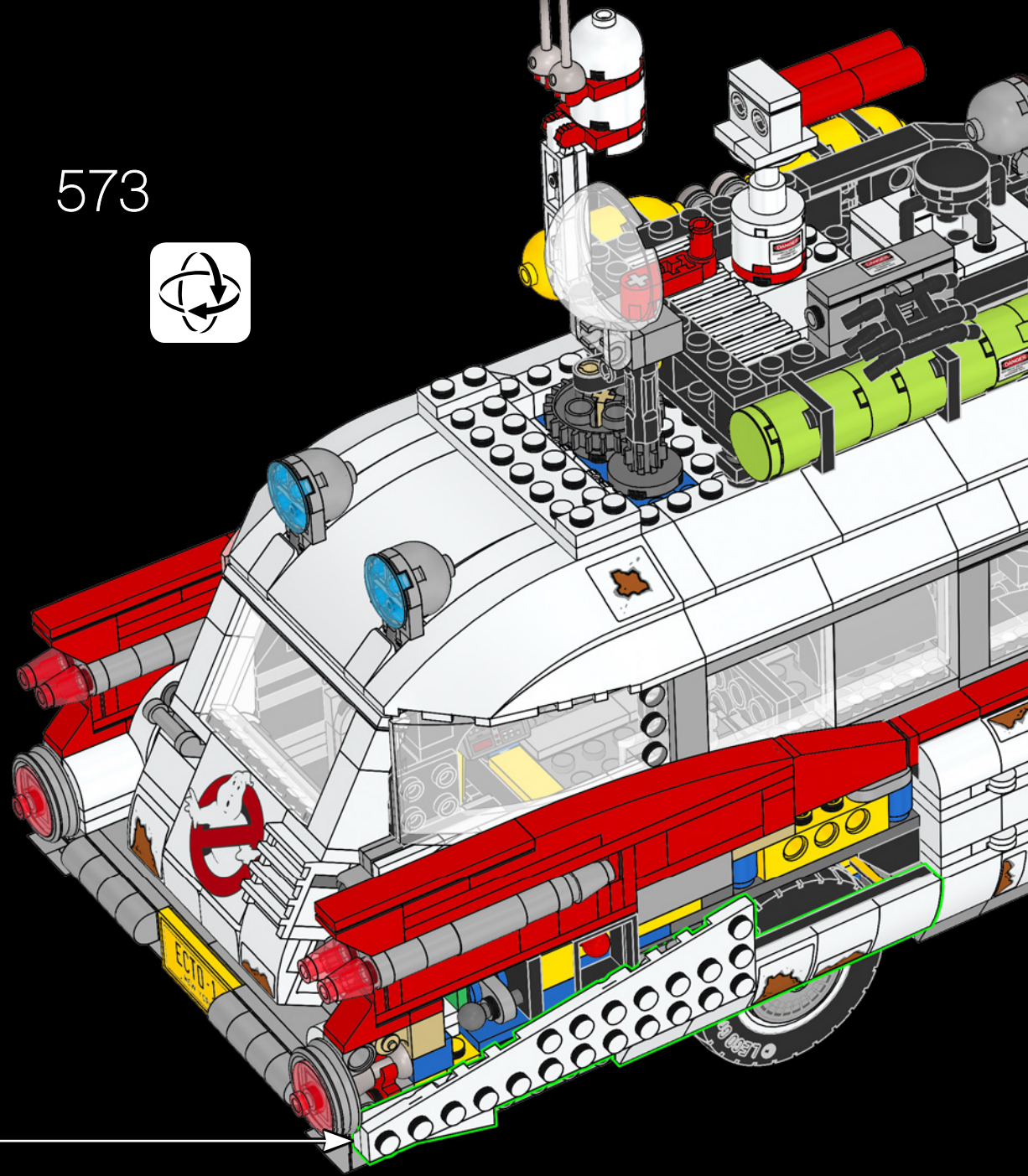

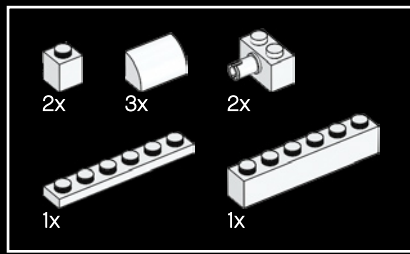

574

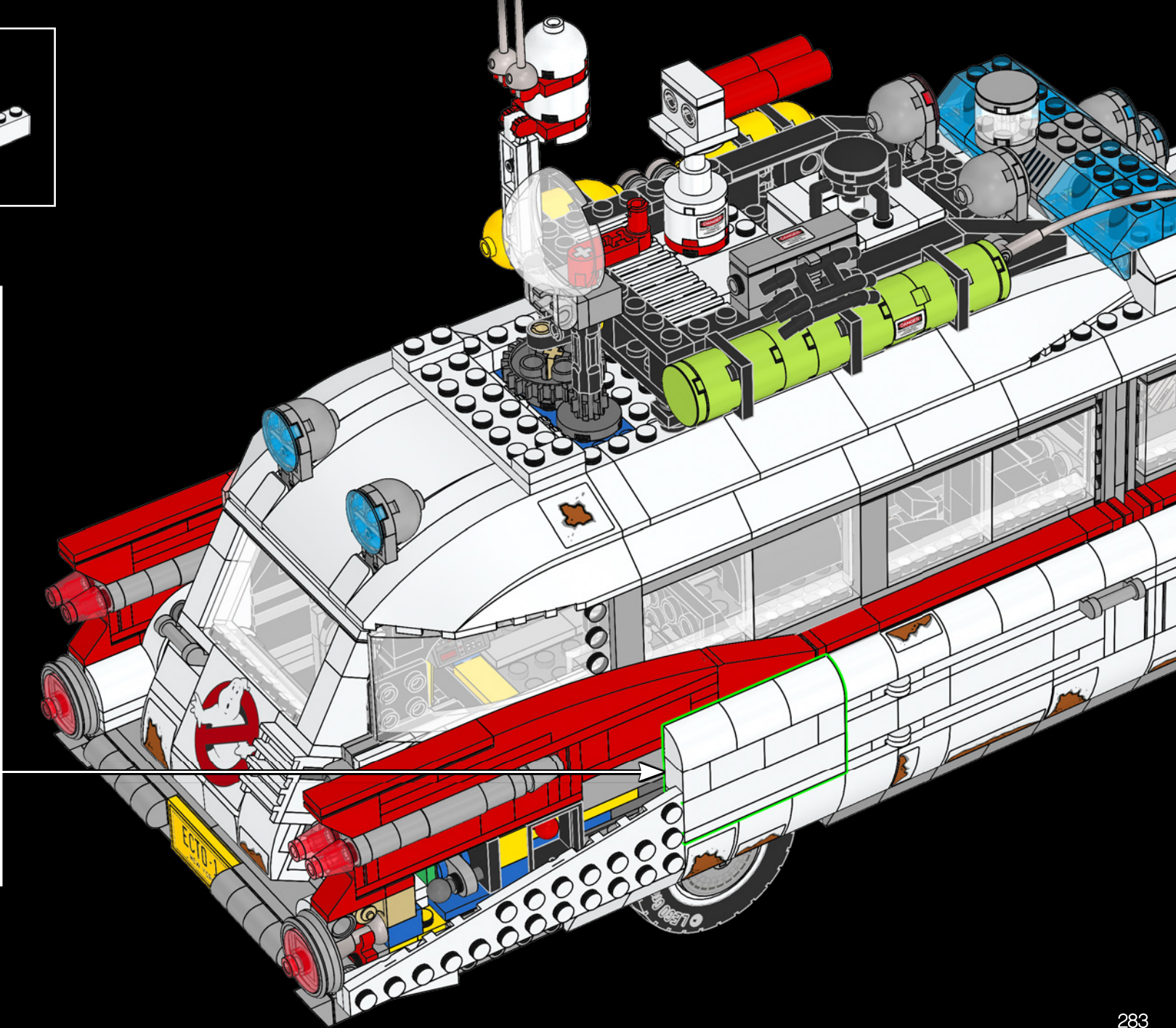
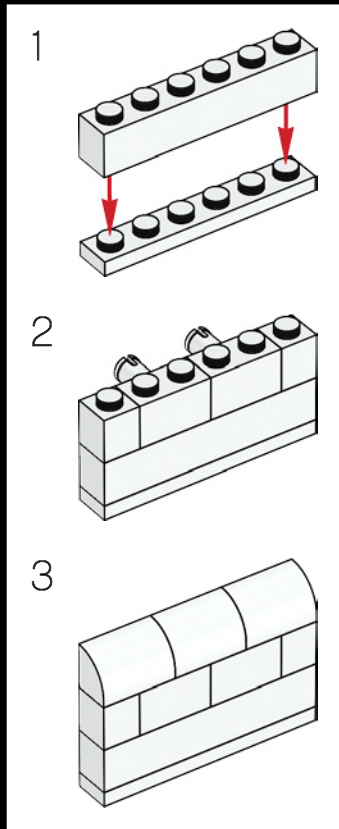

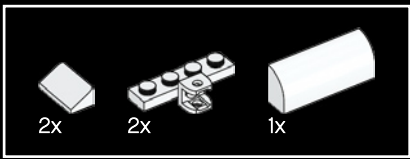

575

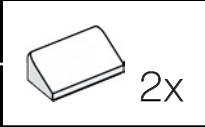
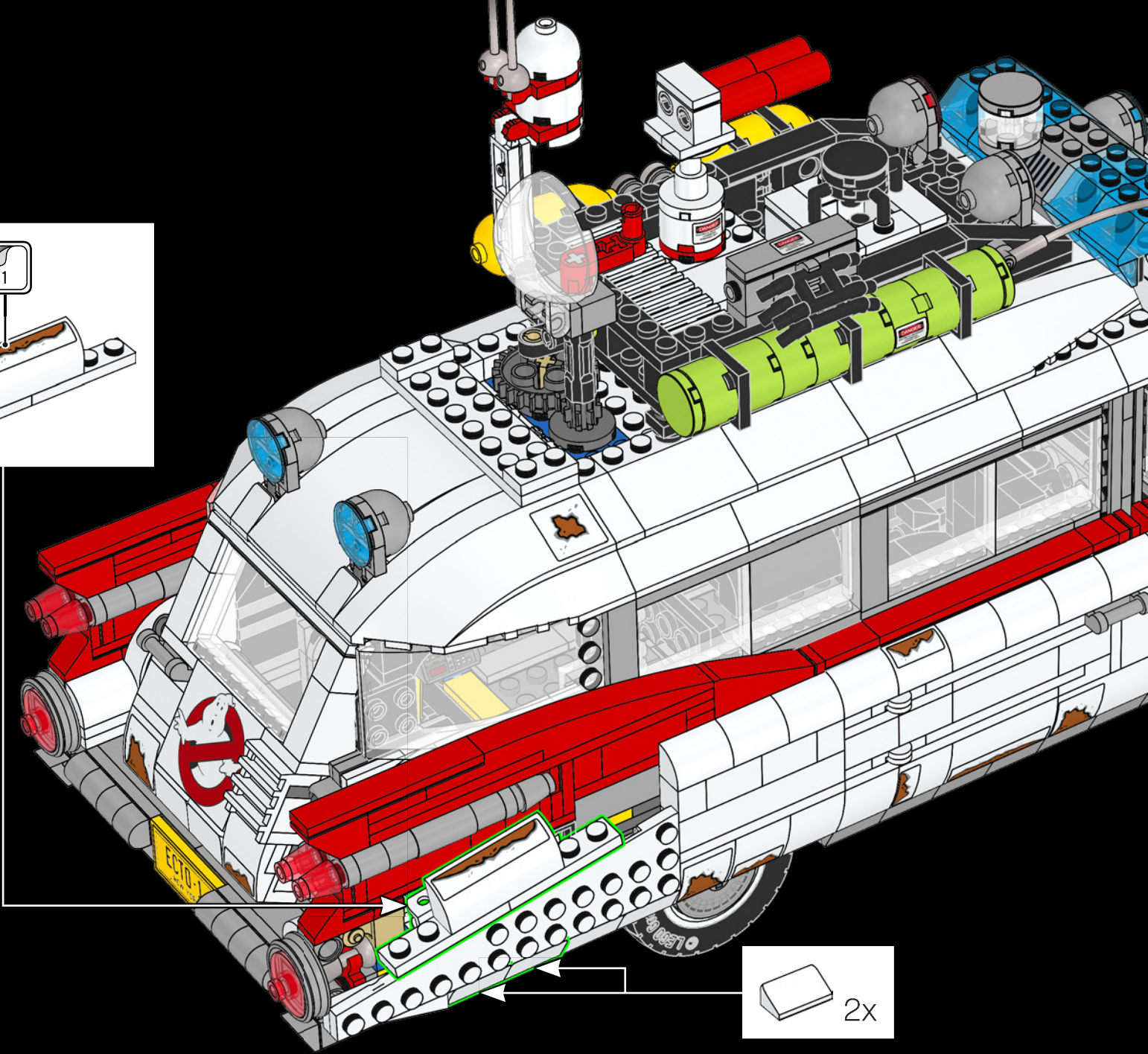
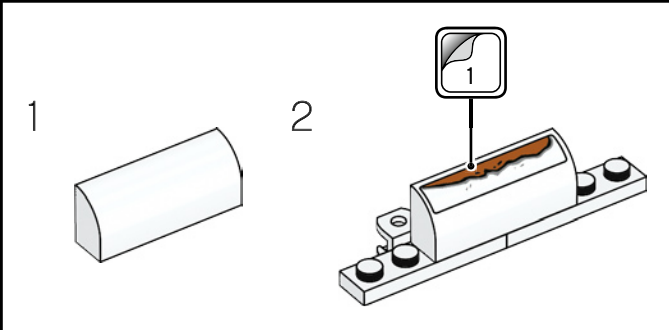

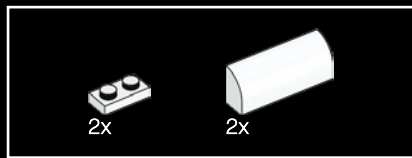

576

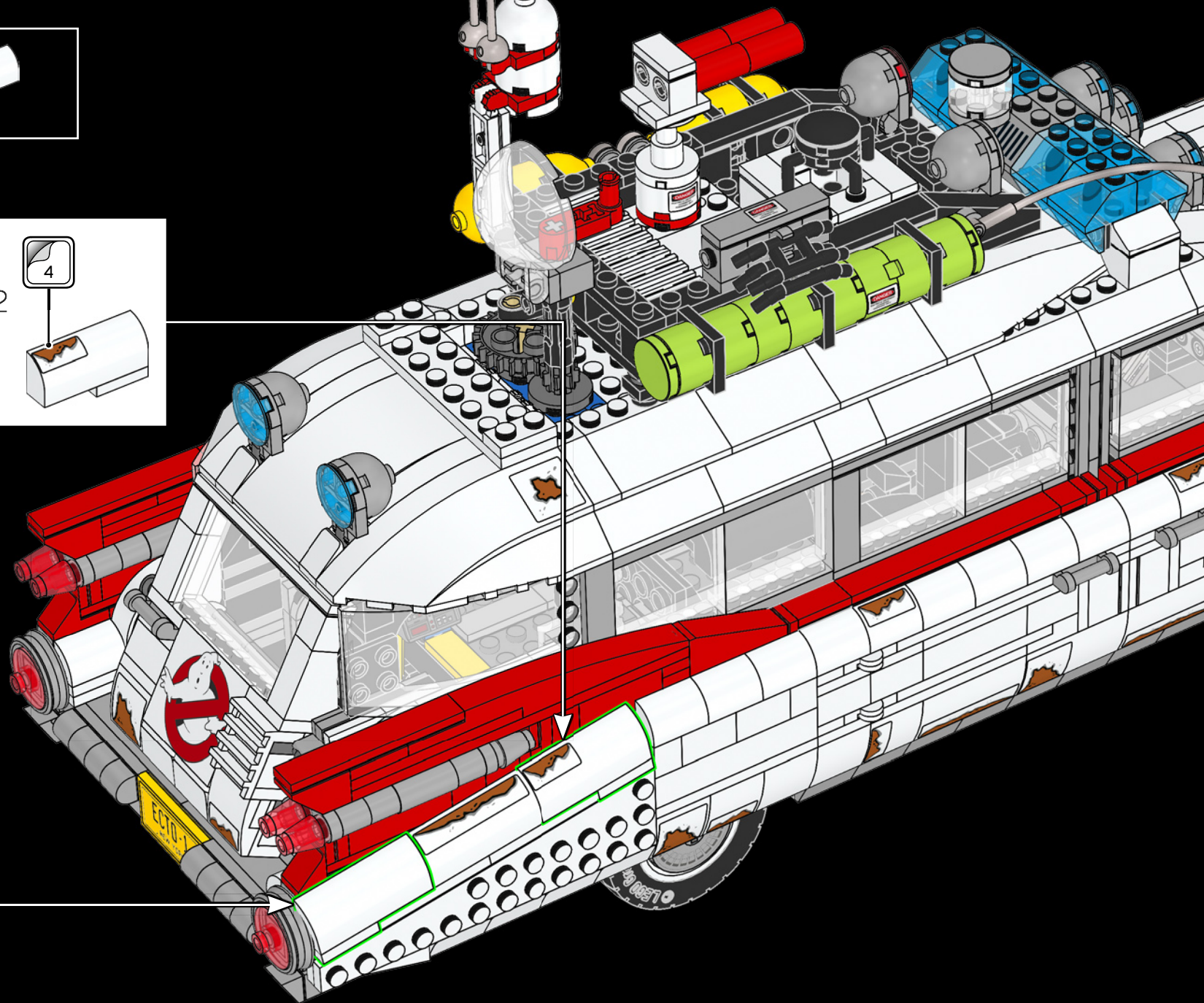
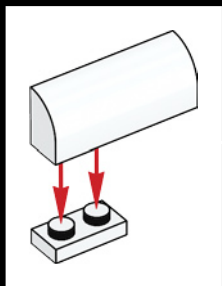
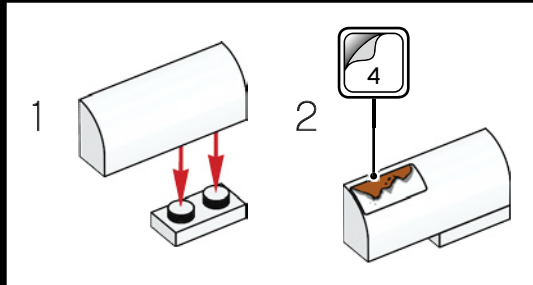

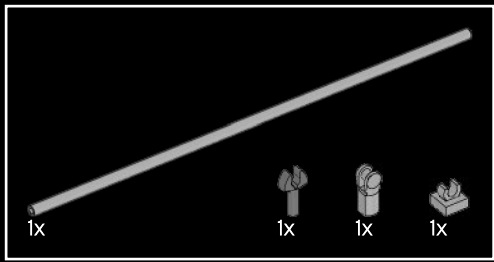

577

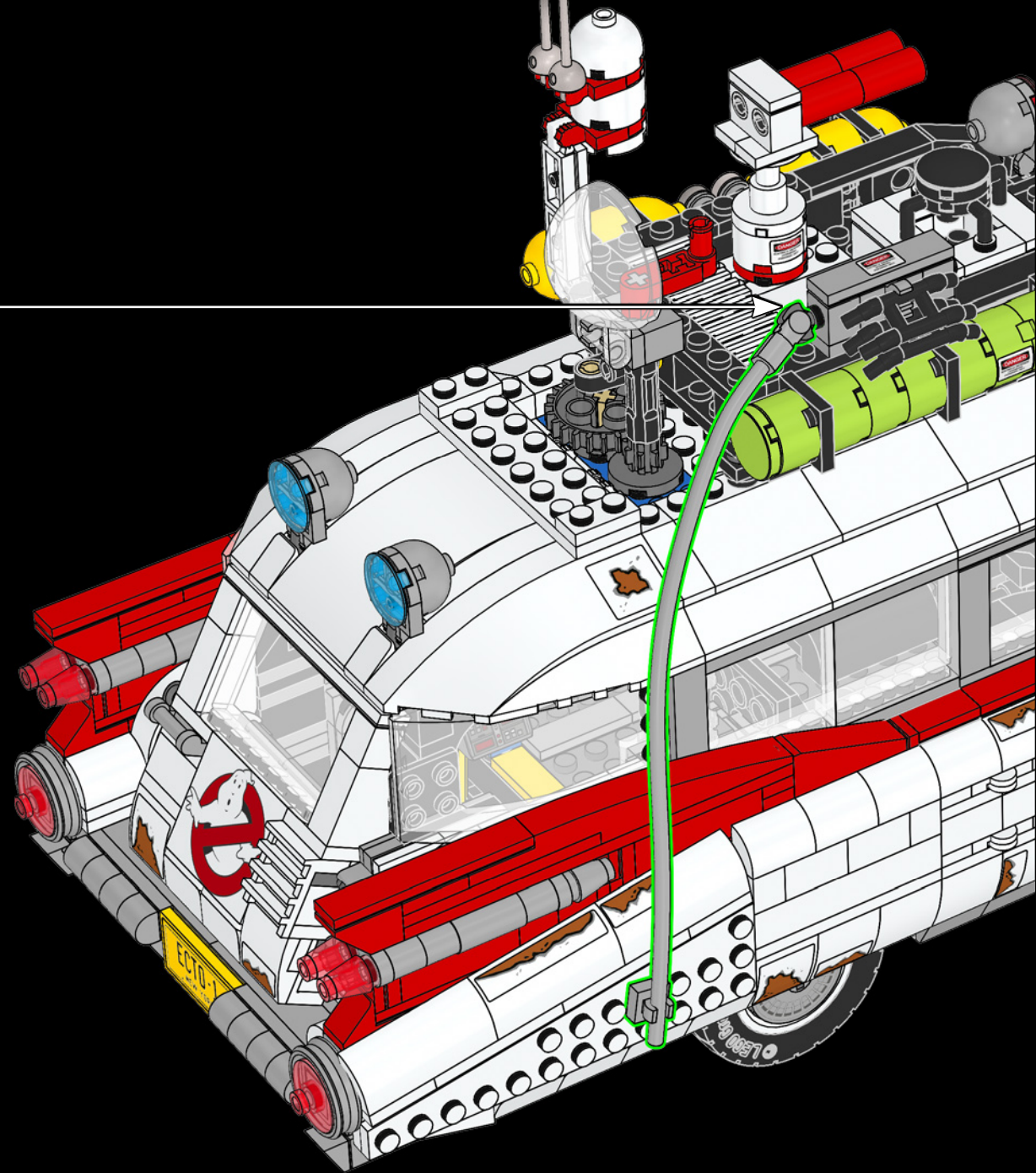
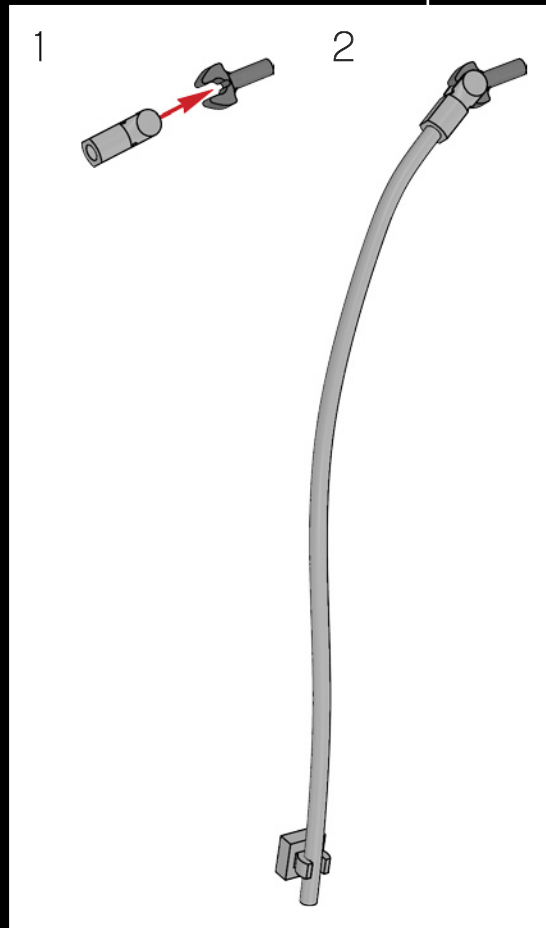

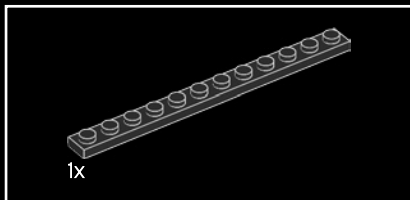
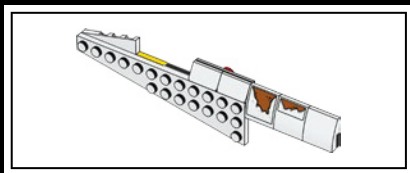

578

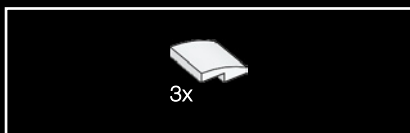
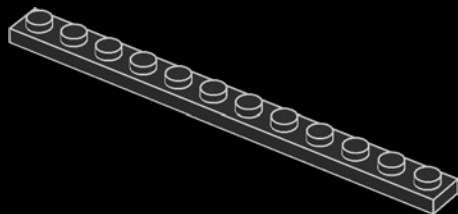

579

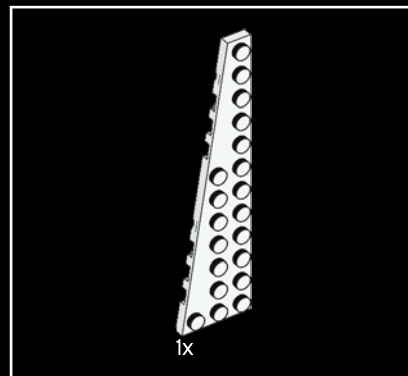
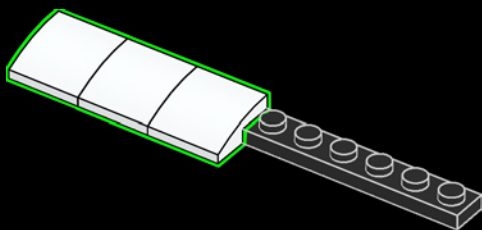

580

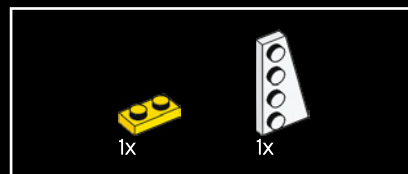
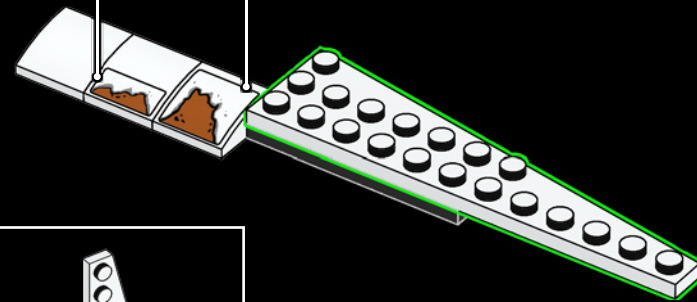

581

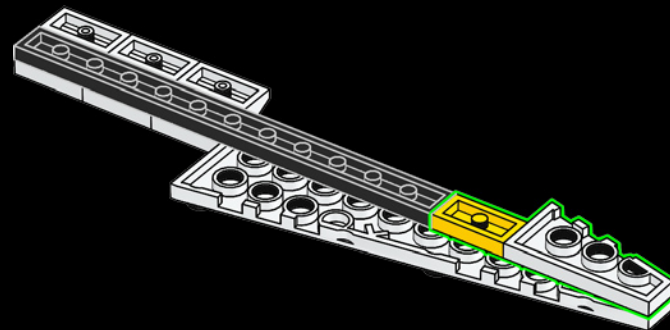



582

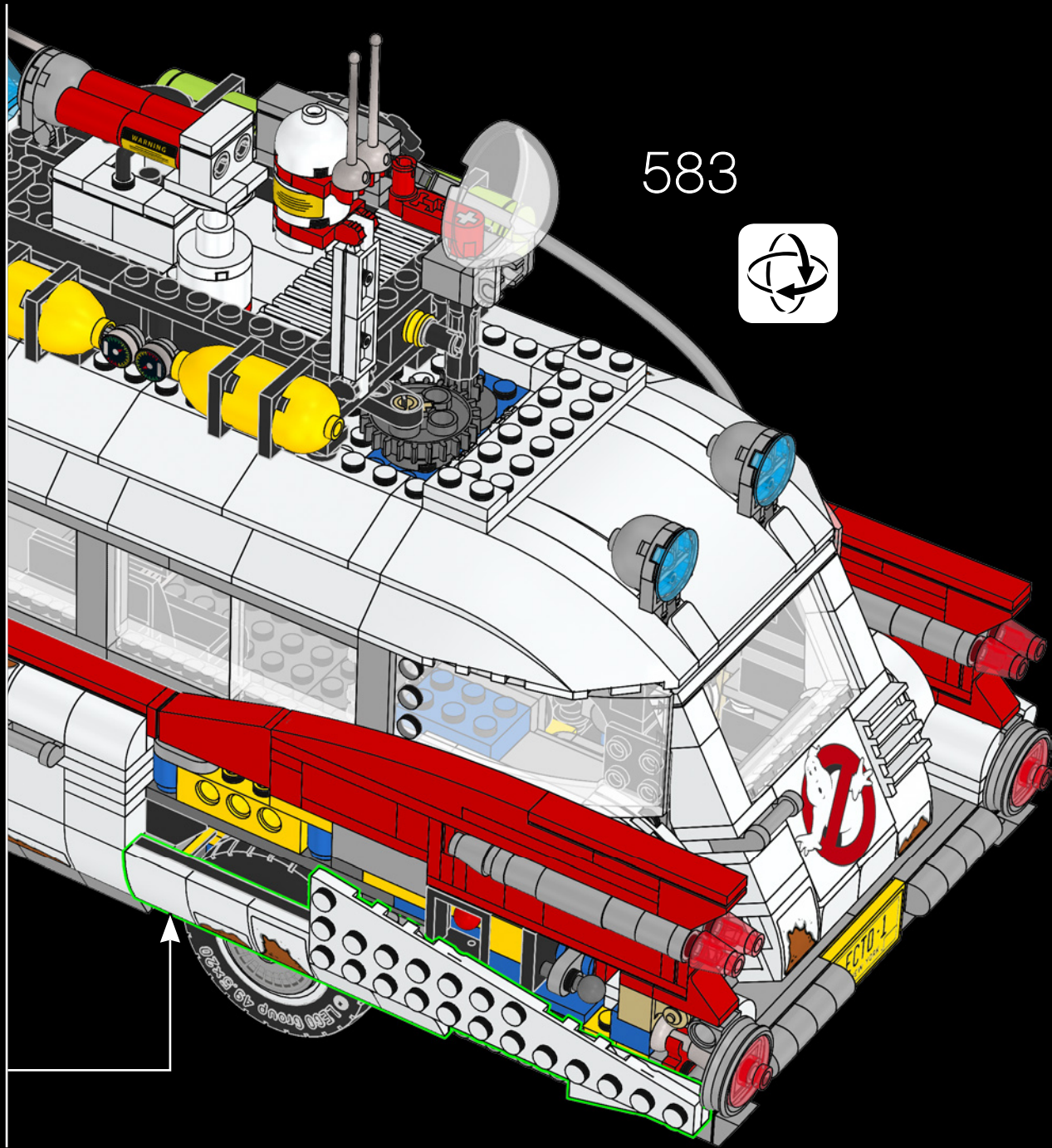
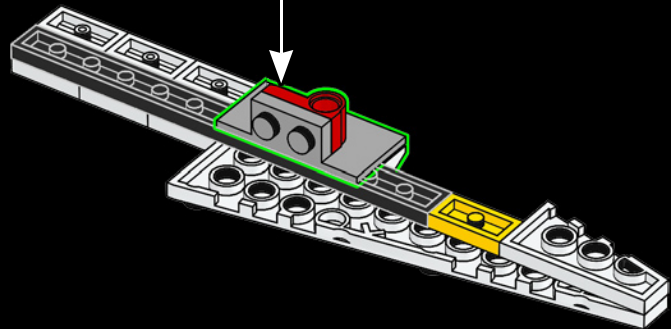
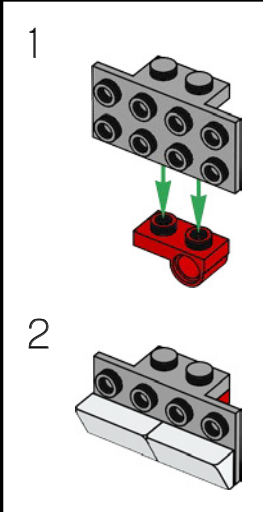

583







584

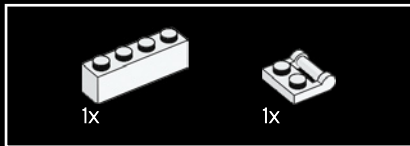
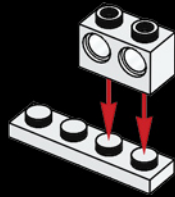

585

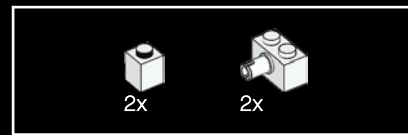
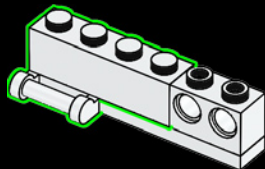

586

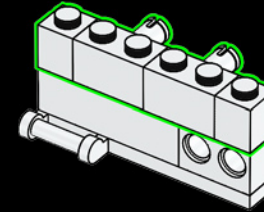

587

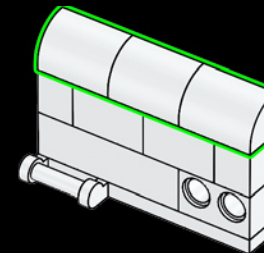

588

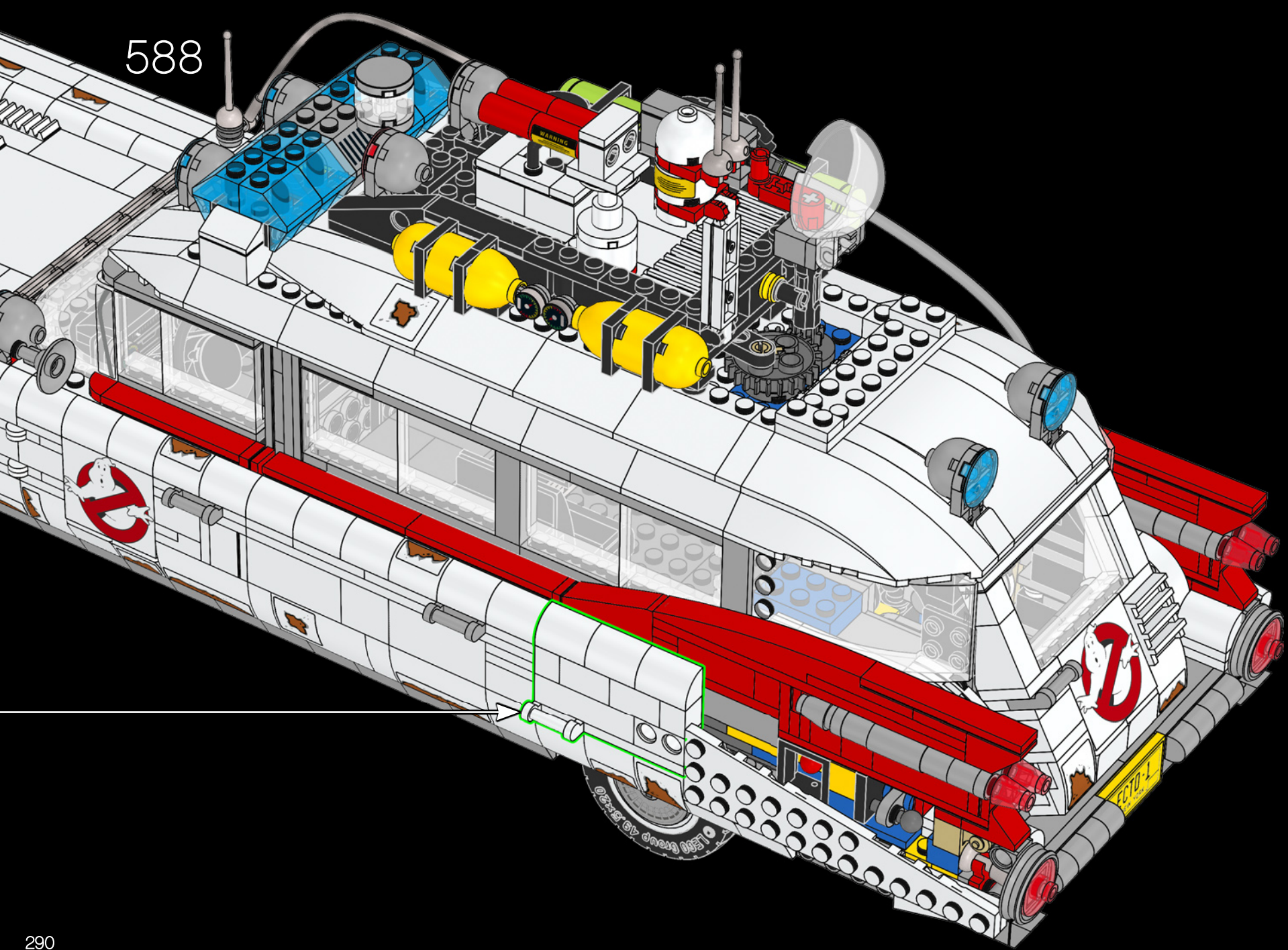

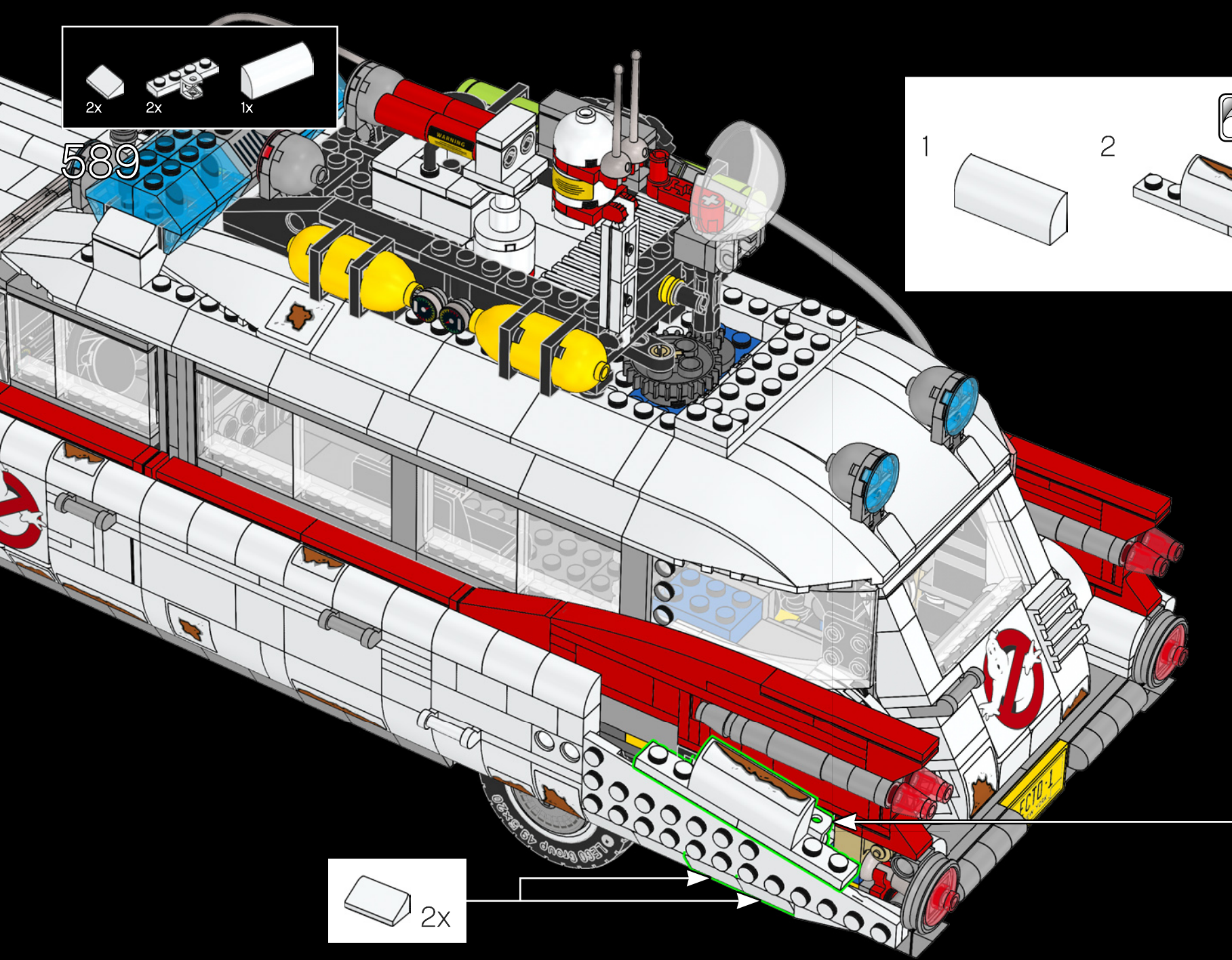

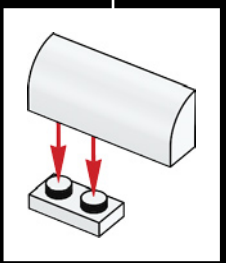
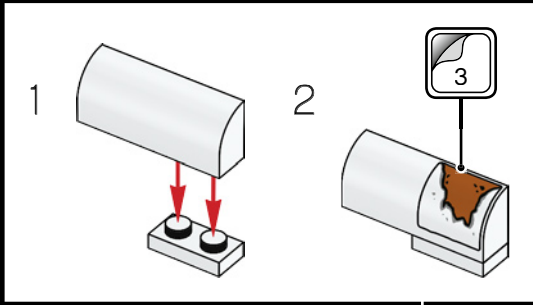
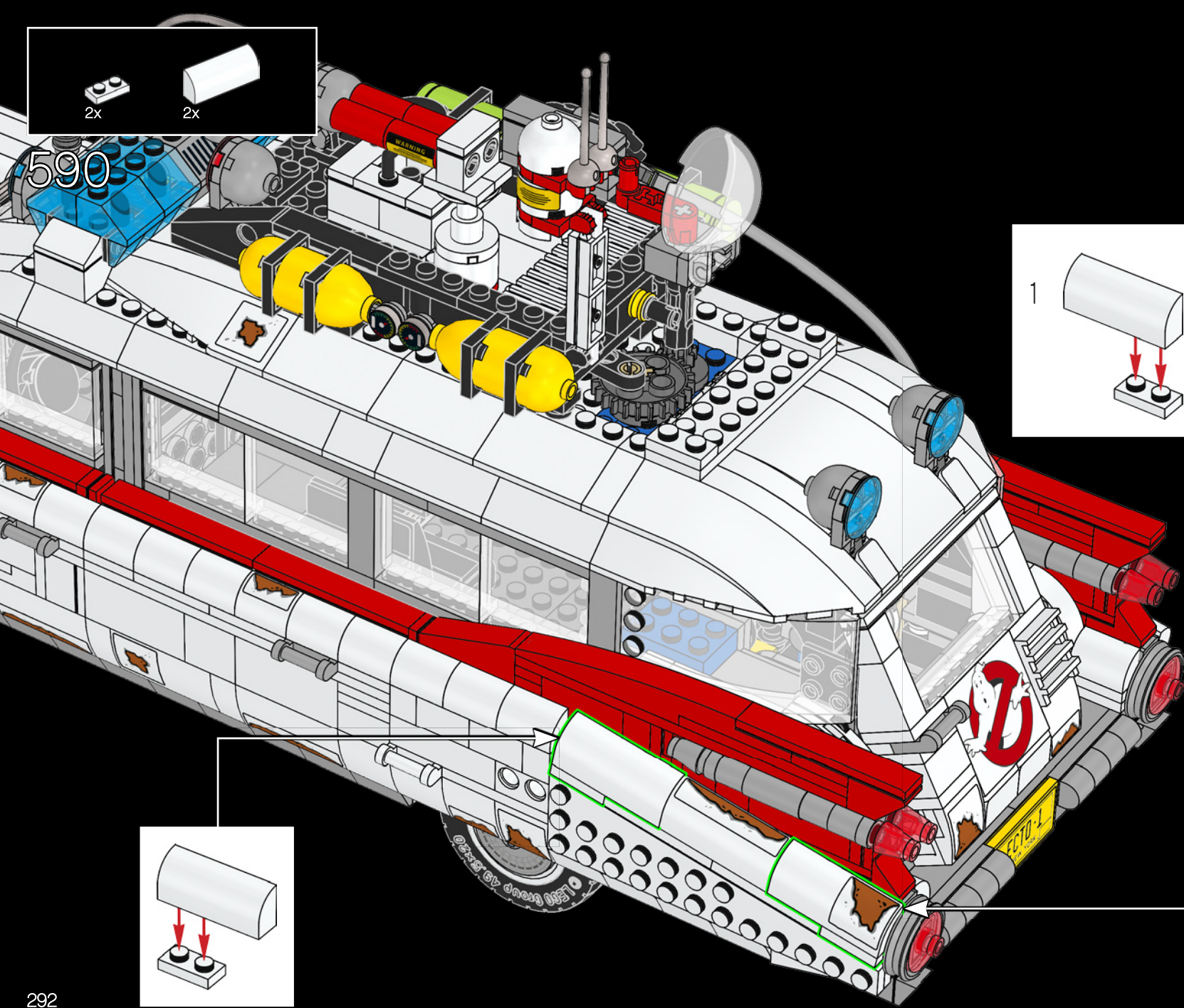

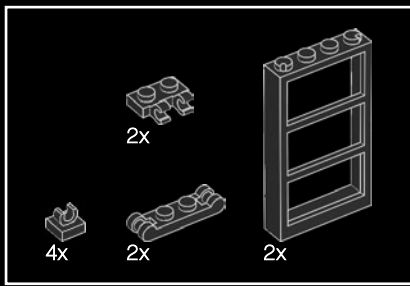

591

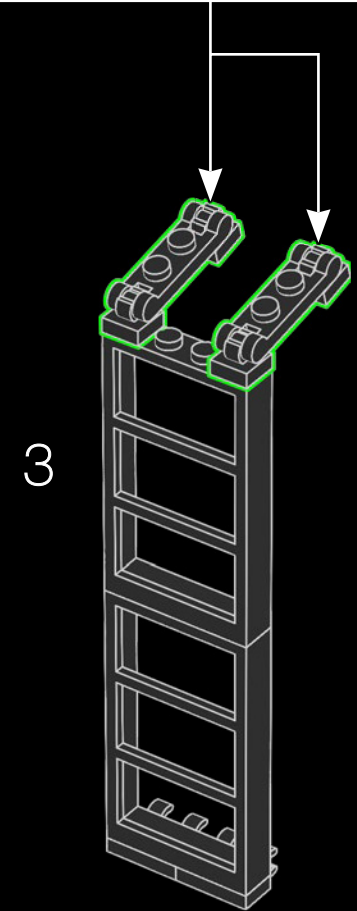
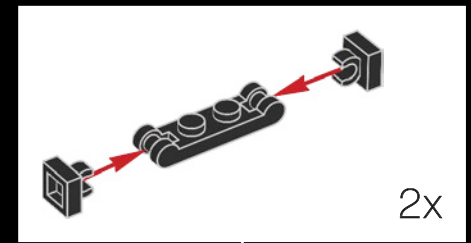
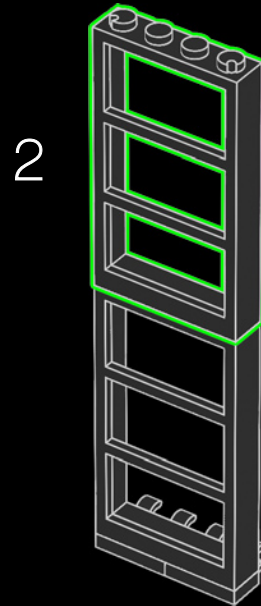
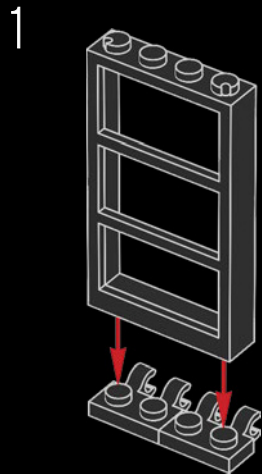

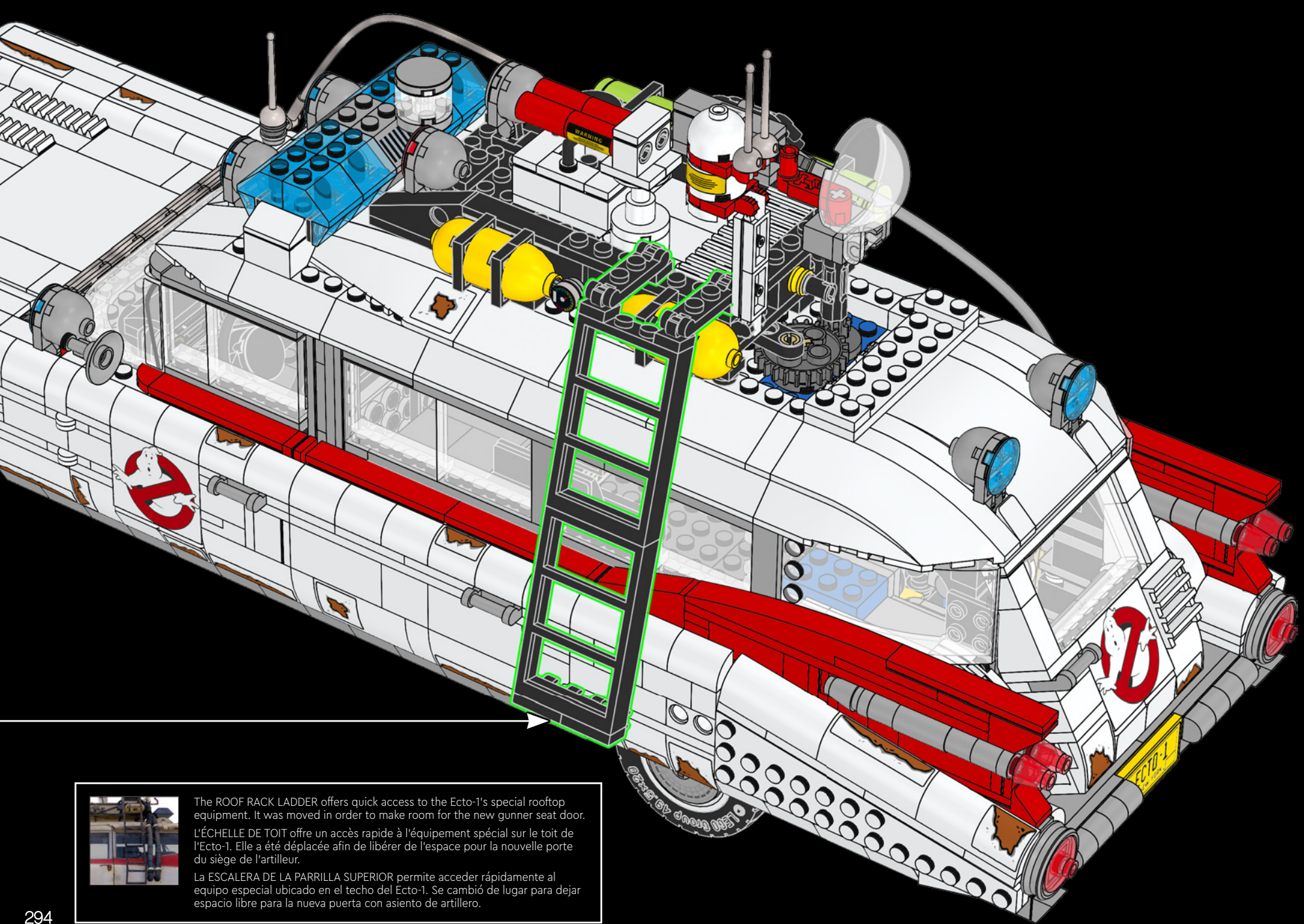

The ROOF RACK LADDER offers quick access to the Ecto-1's special rooftop equipment. It was moved in order to make room for the new gunner seat door.

L'ÉCHELLE DE TOIT offre un accès rapide à l'équipement spécial sur le toit de l'Ecto-1. Elle a été déplacée afin de libérer de l'espace pour la nouvelle porte du siège de l'artilleur.

La ESCALERA DE LA PARRILLA SUPERIOR permite acceder rápidamente al equipo especial ubicado en el techo del Ecto-1. Se cambió de lugar para dejar espacio libre para la nueva puerta con asiento de artillero.

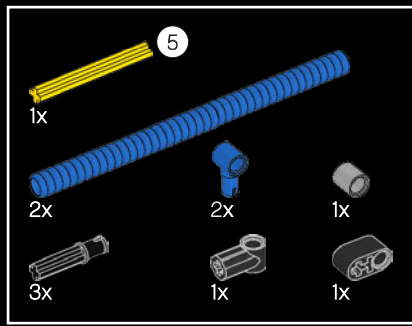

592

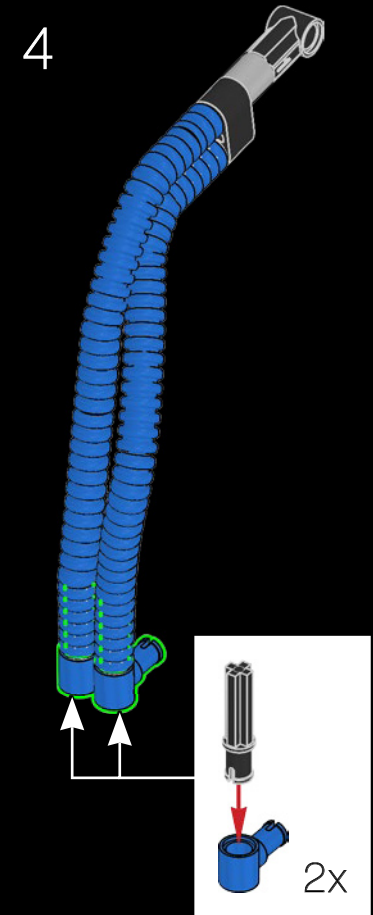
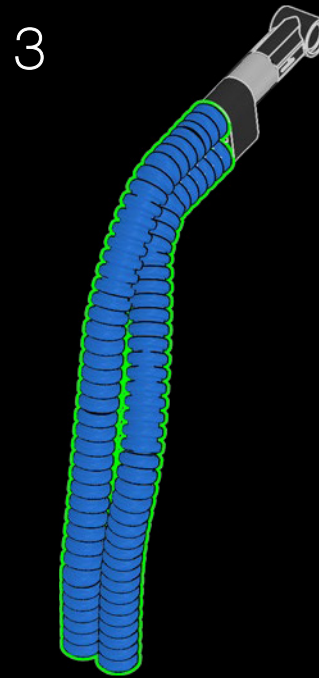
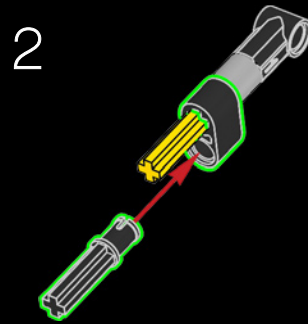
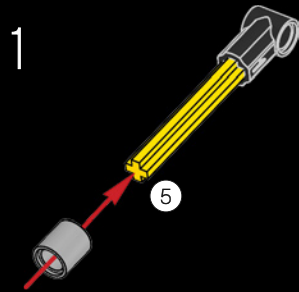

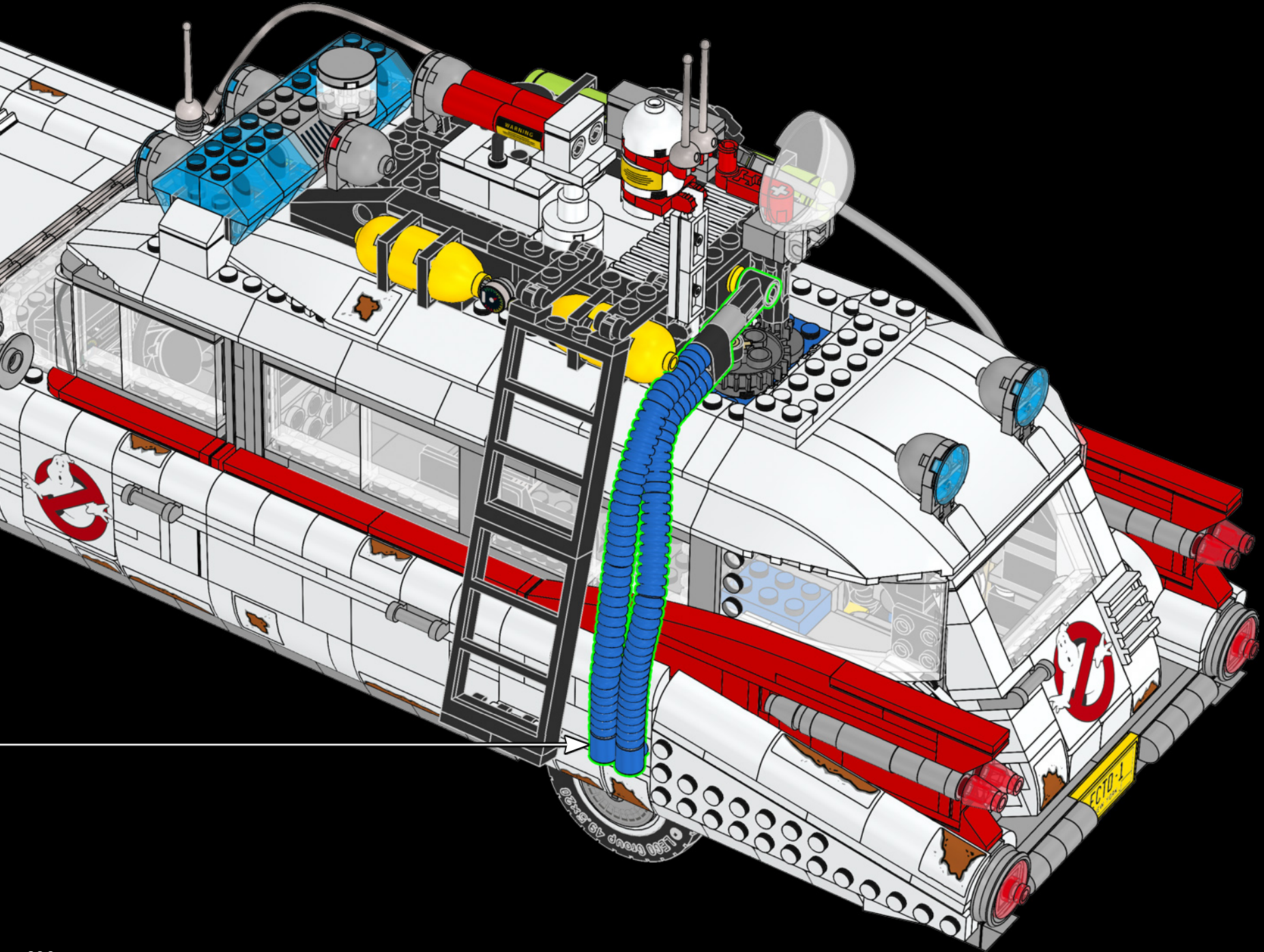



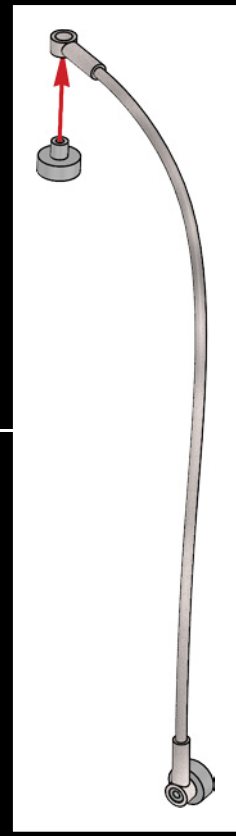
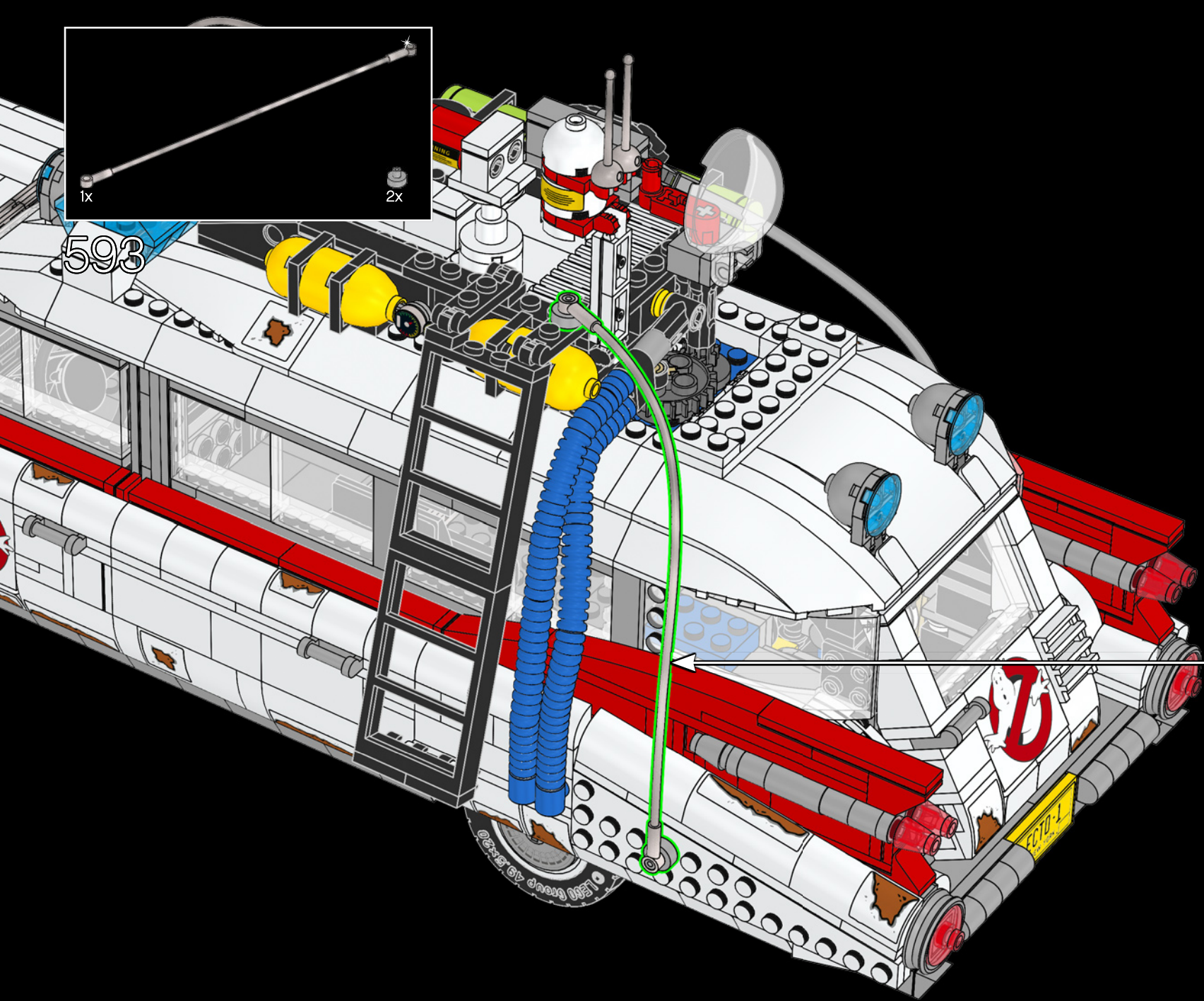

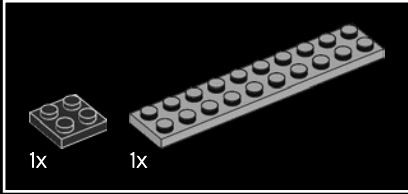
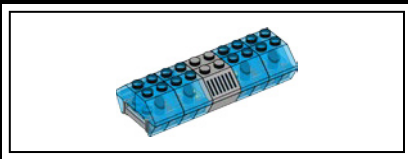

594

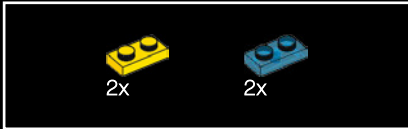
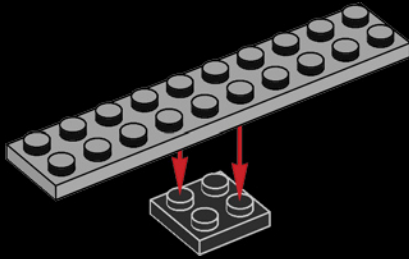

595

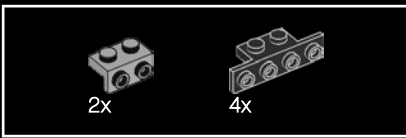
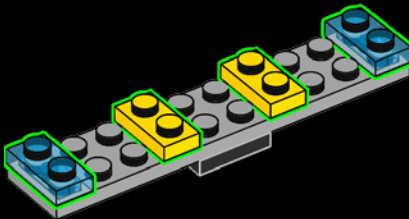

596

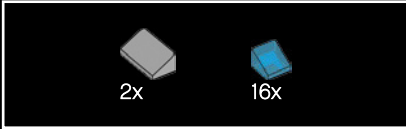
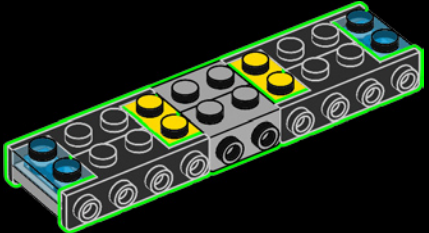

597

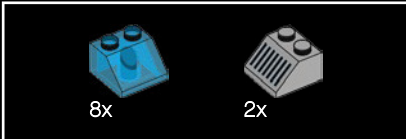
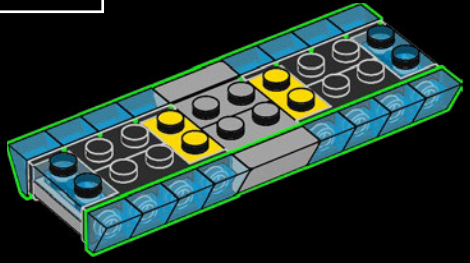

598

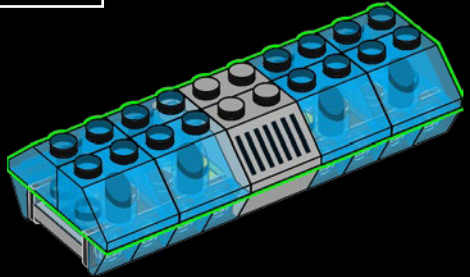

599

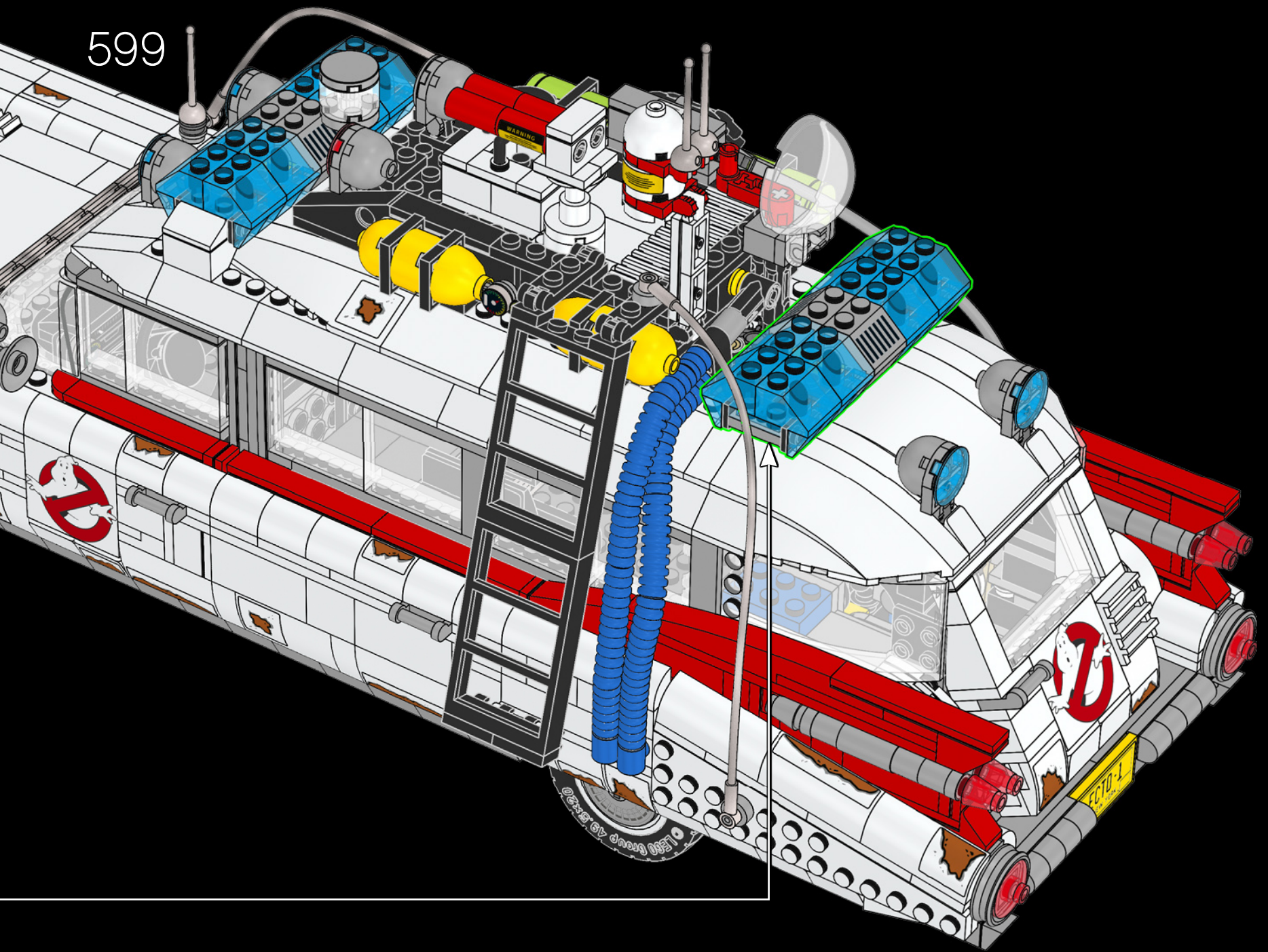

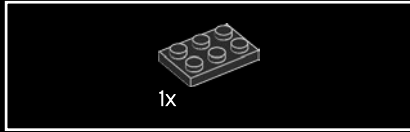

600

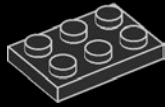

601

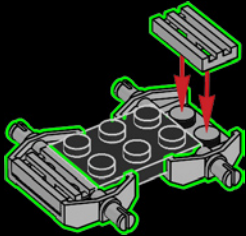

602

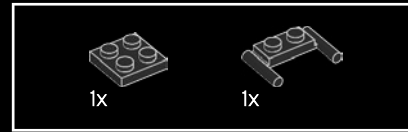
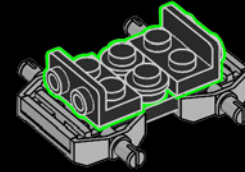

603

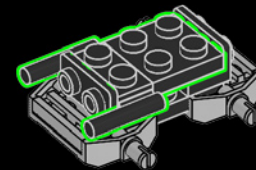



604

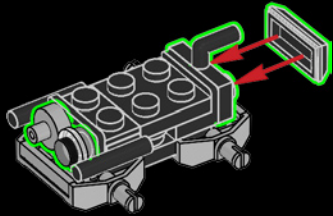

605

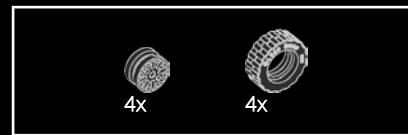
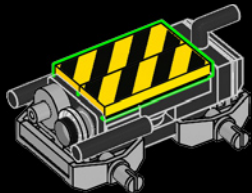

606

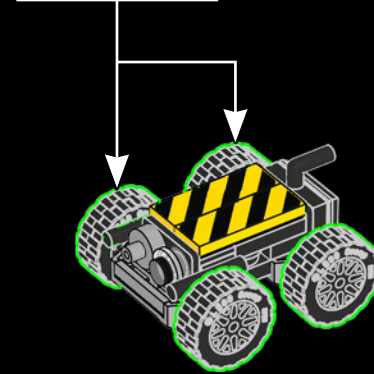
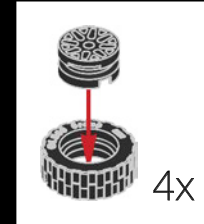

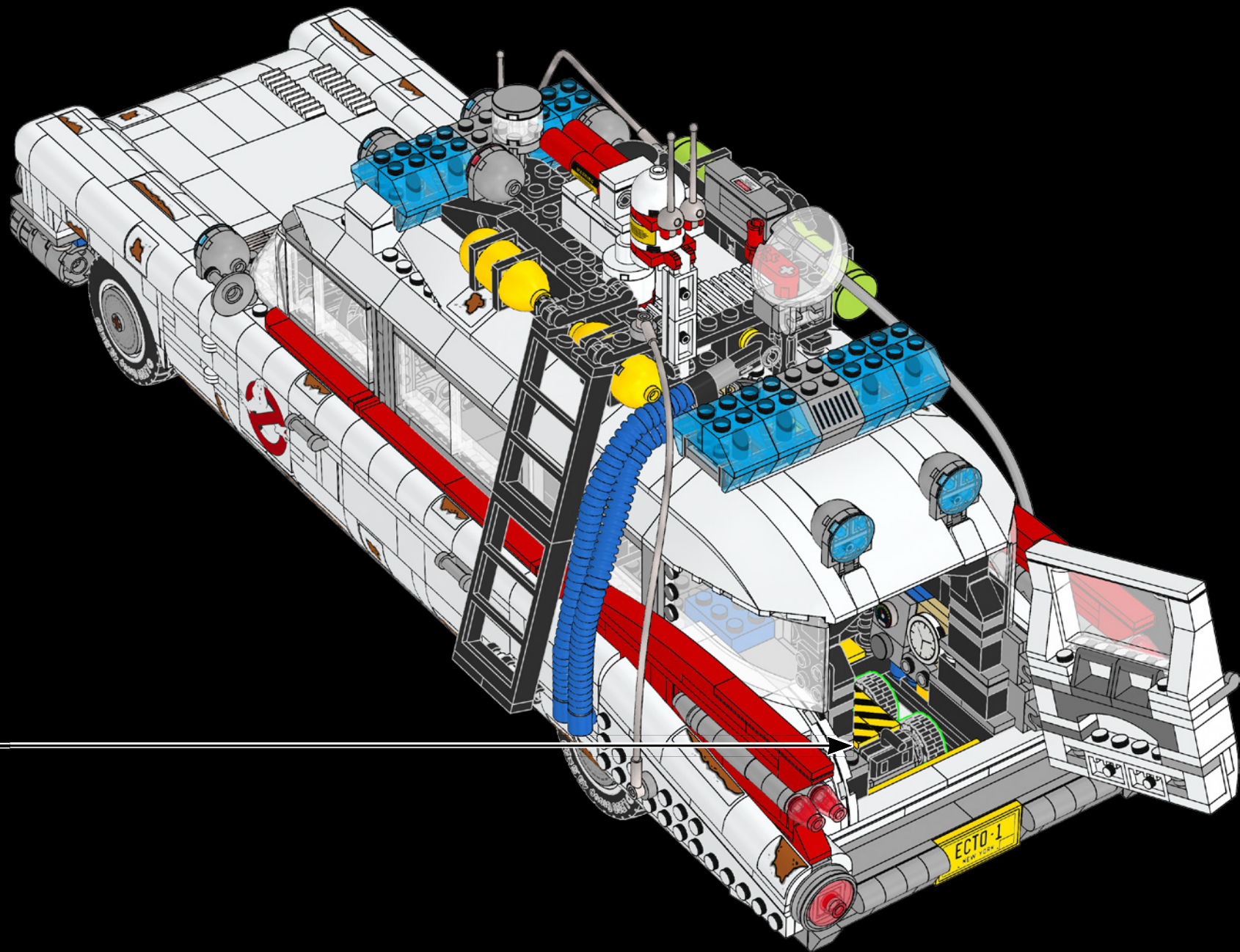

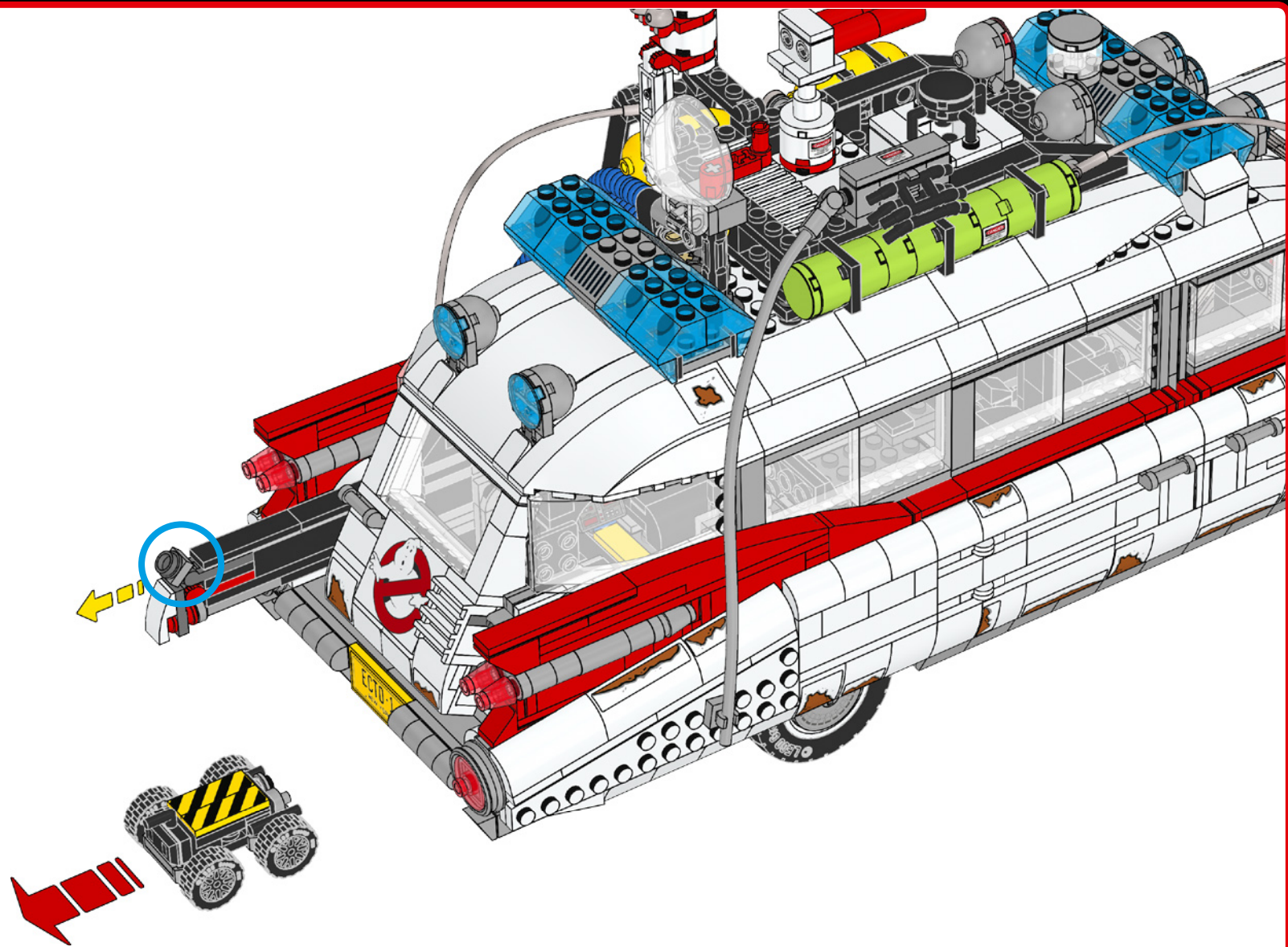



608

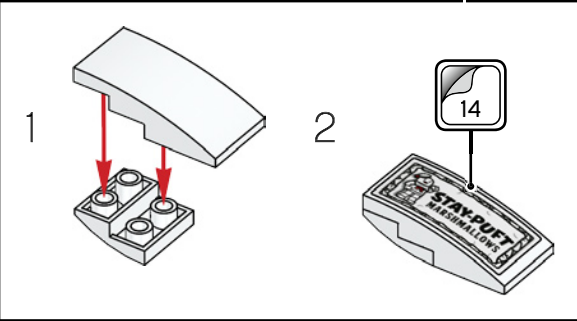
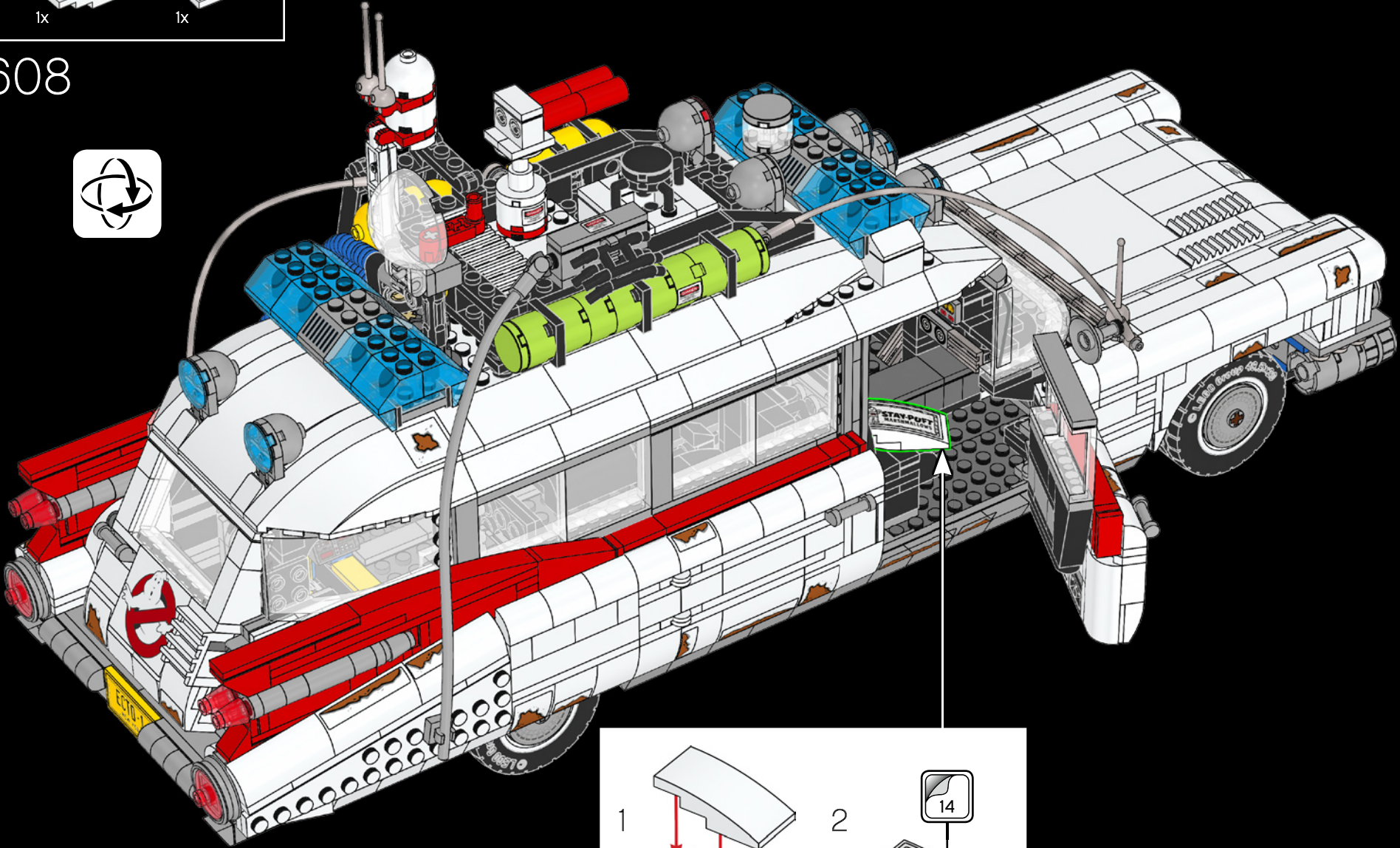



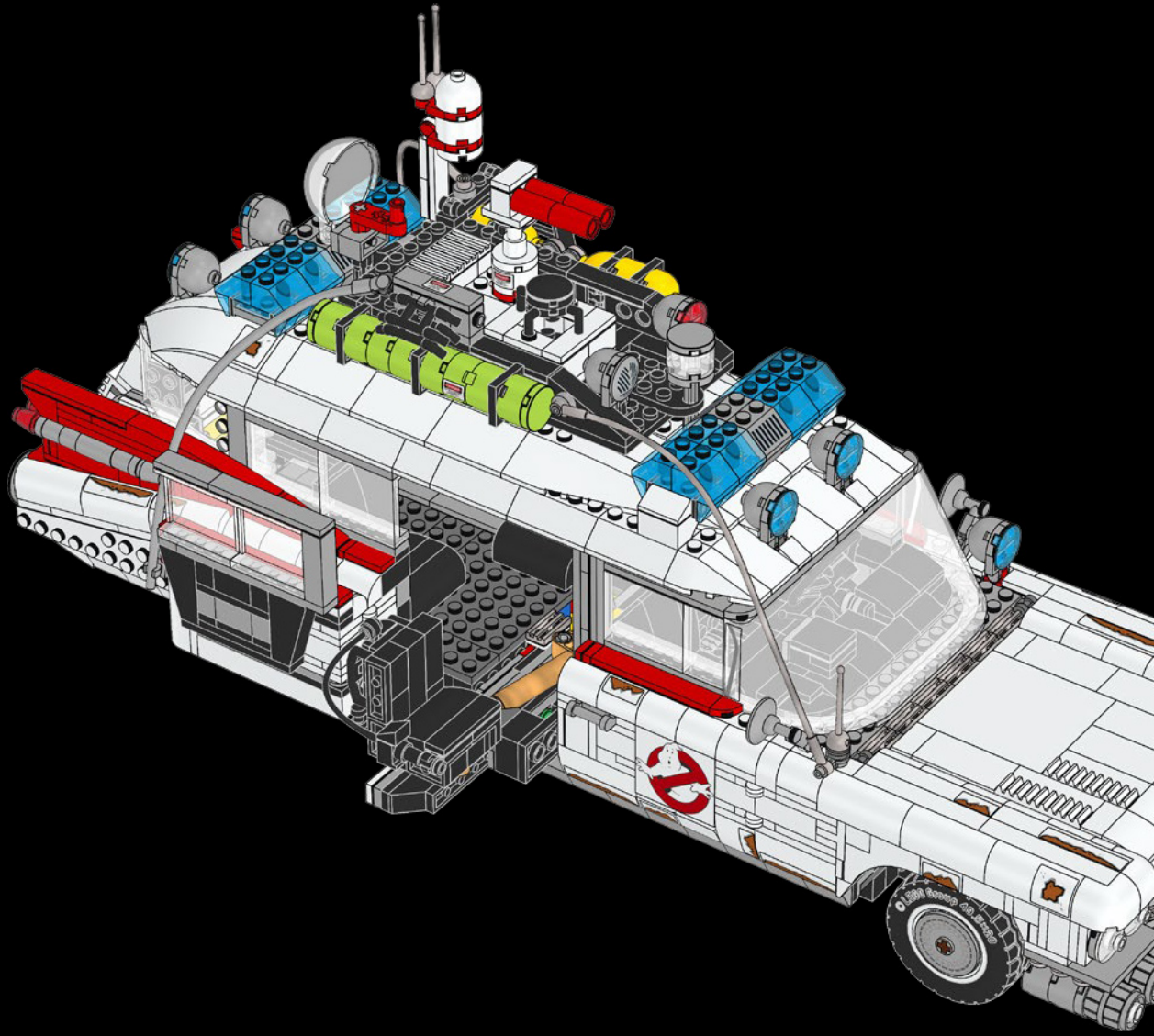
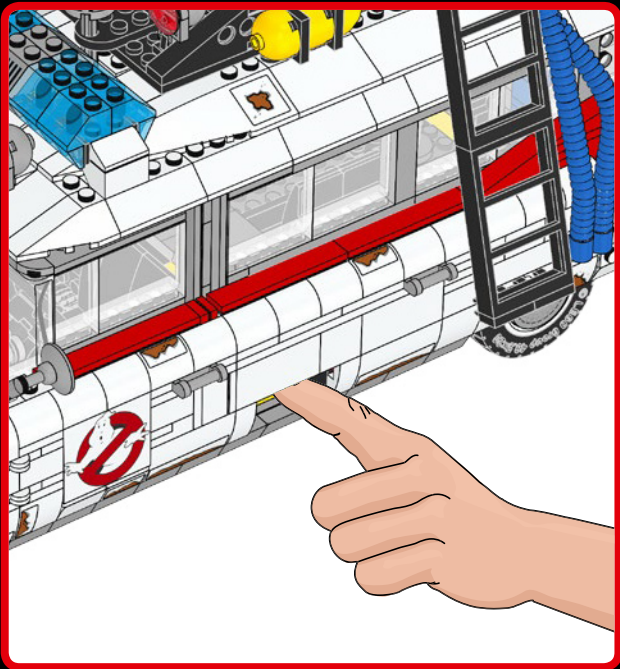
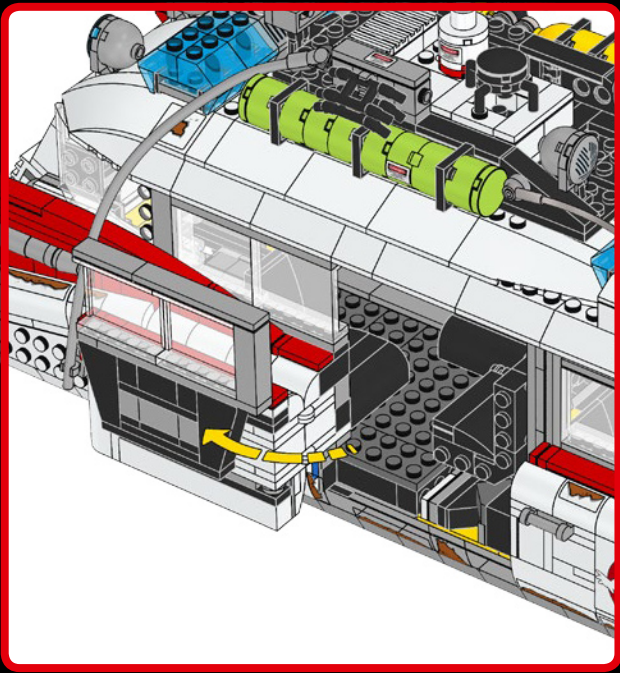

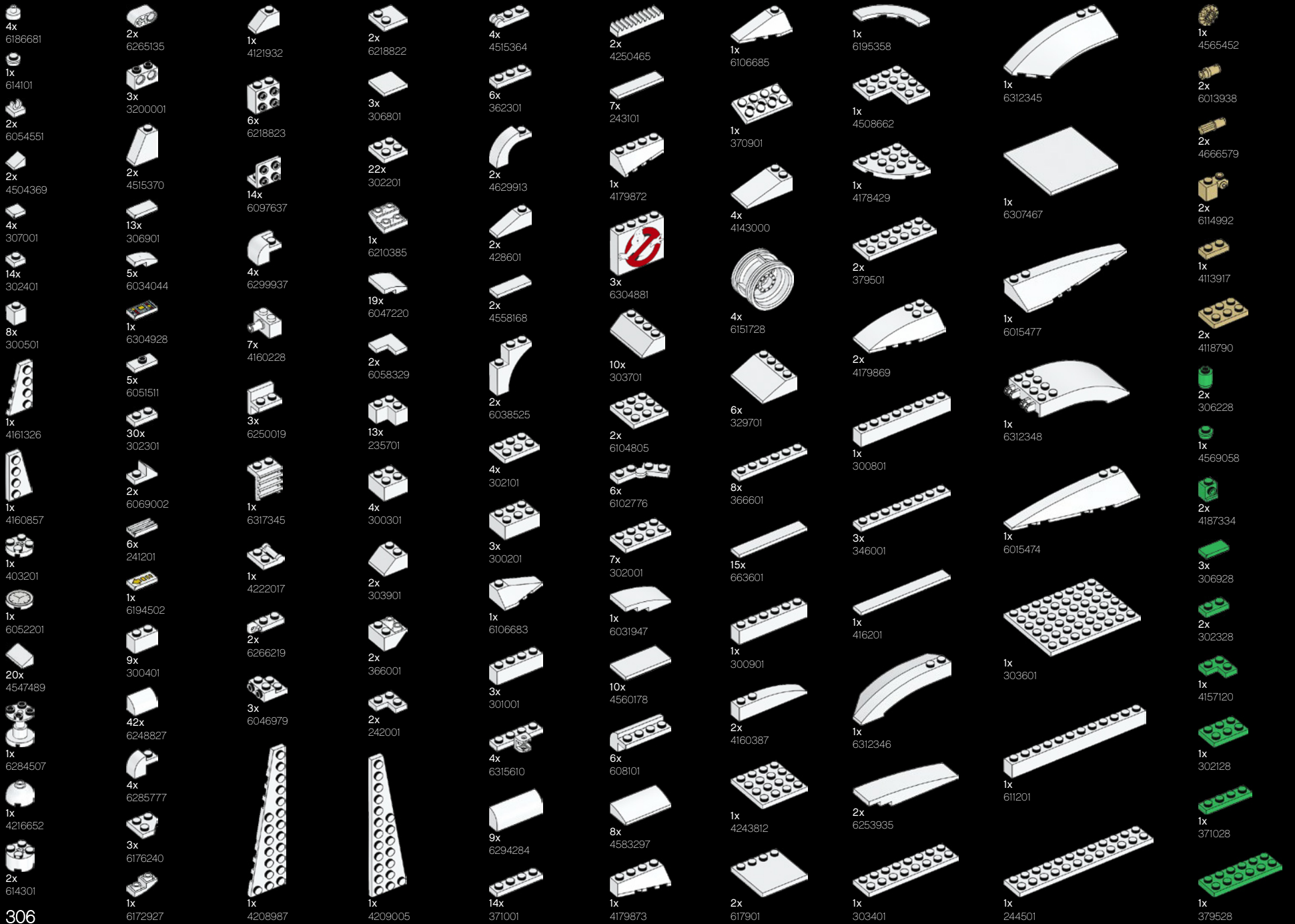

4x 6186681  
 1x 614101  
 2x 6054451  
 2x 4504369  
 4x 307001  
 14x 302401  
 8x 300501  
 1x 4161326  
 1x 4160857  
 1x 403201  
 1x 6052201  
 20x 4547489  
 1x 6284507  
 1x 4216652  
 2x 614301

2x 6265135  
 3x 3200001  
 2x 4515370  
 13x 306901  
 5x 6034044  
 1x 6304928  
 5x 6051511  
 30x 302301  
 2x 6069002  
 6x 241201  
 1x 6194502  
 9x 300401  
 42x 6248827  
 4x 6285777  
 3x 6176240  
 1x 6172927

1x 4121932  
 6x 6218823  
 14x 6097637  
 4x 6299937  
 7x 4160228  
 3x 6250019  
 1x 6317345  
 1x 4222017  
 2x 6266219  
 3x 6046979  
 1x 4208987

2x 6218822  
 3x 306801  
 22x 302201  
 1x 6210385  
 19x 6047220  
 2x 6058329  
 13x 235701  
 4x 300301  
 2x 303901  
 2x 366001  
 2x 242001  
 1x 4209005

4x 4515364  
 6x 362301  
 2x 4629913  
 2x 428601  
 2x 4558168  
 2x 6038525  
 4x 302101  
 3x 300201  
 1x 6106683  
 3x 301001  
 4x 6315610  
 9x 6294284  
 14x 371001

2x 4250465  
 7x 243101  
 1x 4179872  
 3x 6304881  
 10x 303701  
 2x 6104805  
 6x 6102776  
 7x 302001  
 1x 6031947  
 10x 4560178  
 6x 608101  
 8x 4583297  
 1x 4179873

1x 6106685  
 1x 370901  
 4x 4143000  
 4x 6151728  
 6x 329701  
 8x 366601  
 15x 663601  
 1x 300901  
 2x 4160387  
 1x 4243812  
 2x 617901

1x 6195358  
 1x 4508662  
 1x 4178429  
 2x 379501  
 2x 4179869  
 1x 300801  
 3x 346001  
 1x 416201  
 1x 6312346  
 2x 6253935  
 1x 303401

1x 6312345  
 1x 6307467  
 1x 6015477  
 1x 6312348  
 1x 6015474  
 1x 303601  
 1x 611201  
 1x 244501

1x 4565452  
 2x 6013938  
 2x 4666579  
 2x 6114992  
 1x 4113917  
 2x 4118790  
 2x 306228  
 1x 4569053  
 2x 4187334  
 3x 306928  
 2x 302328  
 1x 4157120  
 1x 302128  
 1x 371028  
 1x 379528

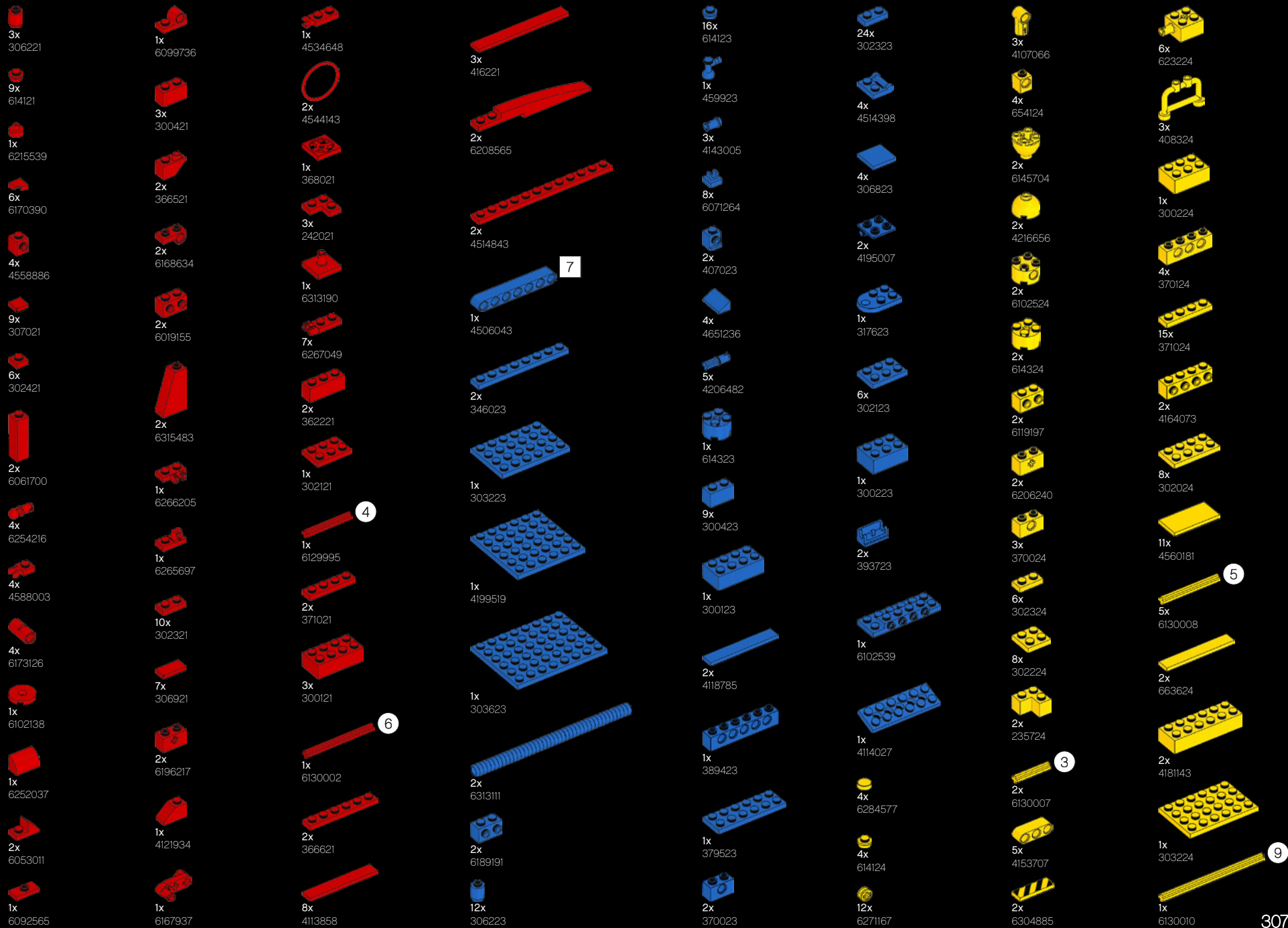

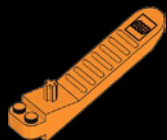

1x  
6240515

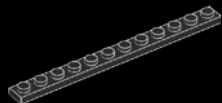

18x  
4514845

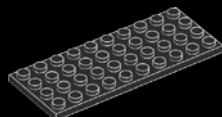

3x  
303026

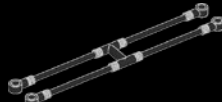

1x  
6096303

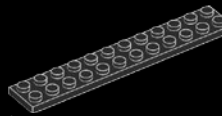

1x  
244526

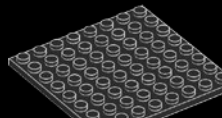

1x  
416619

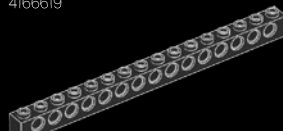

7x  
370326

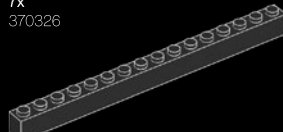

1x  
246526



1x  
73587



1x  
4538456



1x  
306226



2x  
6186675



11x  
614126



4x  
362626



1x  
6121485



1x  
6273589



4x  
4558954



3x  
4504382



6x  
302426



6x  
6066102



4x  
407026



3x  
6234695



4x  
4613162



4x  
4177431



4x  
4177431



1x  
6261993



5x  
6210270



4x  
6157554



1x  
6284699



2x  
4548180



1x  
4278359



1x  
6304888



5x  
403226



2x  
6070695



1x  
6291069



1x  
6122656



1x  
6265091



2x  
4512363



2x  
6226706



1x  
366526



1x  
6268905



1x  
6261348



5x  
6178922



1x  
6114987



1x  
6192309



1x  
6156991



4x  
4617848



36x  
302326



4x  
4636202



3x  
6069000



3x  
6092585



6x  
6184784



3x  
370026



3x  
6266244



4x  
300426



2x  
366526



2x  
4521439



4x  
4144024



1x  
6117973



7x  
6020193



1x  
4584274



8x  
6000650



5x  
6310268



1x  
4535739



3x  
6267131



1x  
306826



8x  
6053077



2x  
6192346



7x  
302226



3x  
6061032



4x  
366026



6x  
6191630



3x  
300326



2x  
6133722



1x  
242026



6x  
235726



7x  
6089119



1x  
6267045



7x  
6052126



1x  
6313508



2x  
6276951



1x  
4142822



4x  
6286381



3x  
6199908



2x  
6078610



13x  
362226



16x  
362326



2x  
6265712



1x  
428626



6x  
428726



6x  
4581280



1x  
317626



8x  
6168620



3x  
6099483



2x  
6162892



3x  
302126



1x  
383926



2x  
300226



1x  
4107136



19x  
243126



6x  
6039869



8x  
301026



3x  
4162443



2x  
6037746



1x  
370126



14x  
371026



2x  
6271169



2x  
303726



1x  
4515350



2x  
4227684



1x  
4159550



2x  
6280168



1x  
6299938



2x  
6194233



16x  
302026



5x  
6174252



3x  
4587844



8x  
4647286



4x  
300126



1x  
6092878



2x  
4629921



13x  
366626



5x  
300926



2x  
6311889



9x  
4243819



2x  
6208787



1x  
6271573

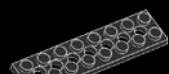

1x  
373826

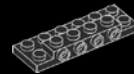

5x  
4653049

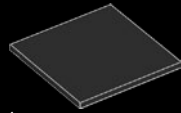

1x  
6155125



1x  
4495935

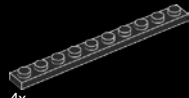

4x  
447726

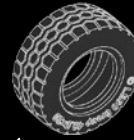

4x  
6055626

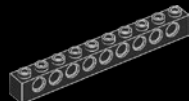

2x  
273026



1x  
370226

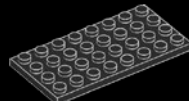

6x  
303526

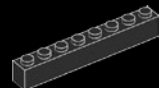

3x  
300826

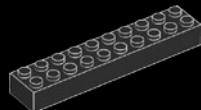

3x  
4617860



12x  
346026

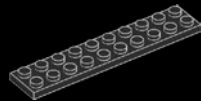

1x  
383226



1x  
416226

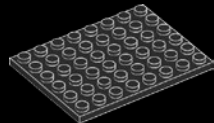

1x  
303626

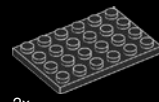

2x  
303226

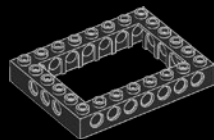

5x  
4188143

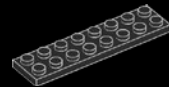

2x  
303426



9x  
6240030



1x  
6168665



2x  
6254254



1x  
6273152



4x  
6245306



2x  
6211814



10x  
6245269

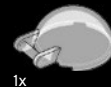

1x  
6244781



1x  
6254638



2x  
6311888

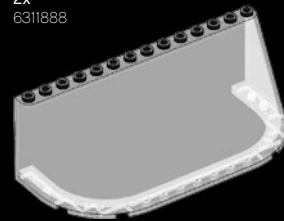

1x  
6299933



4x  
4544720



1x  
6254635



2x  
6245303



32x  
6245256



5x  
6171732



4x  
6240215



16x  
6244887



2x  
6251292



2x  
6092766



8x  
4527943



2x  
6135494



3x  
6152107



1x  
4211412



4x  
4529241



8x  
6284071



4x  
6258831



17x  
4211525



1x  
6194808



3x  
6275844



5x  
6183784



2x  
4211503



1x  
4211483



2x  
4558953



4x  
6308012



20x  
6176433



9x  
4211399



7x  
4211415



14x  
6262085



4x  
4521921



2x  
6061702



8x  
4211389



2x  
6225242



2x  
6248078



1x  
4211758



13x  
6248890



2x  
6311384



1x  
4211794



4x  
6227897



6x  
4533772



1x  
4211791



4x  
6173127



34x  
4568637



1x  
4211475



4x  
6278993



2x  
4211512



1x  
6052200



7x  
4211637



3x  
4211807



1x  
4540203



2x  
4211526



6x  
6183782



3x  
6123815



4x  
4211862



2x  
6043656



1x  
4212363



2x  
6313114



3x  
4211388



1x  
4227776



19x  
4211398



2x  
4211414



1x  
6206249



2x  
6225230



7x  
6266209



2x  
4211350



3x  
6066097



2x  
6285778



2x  
4654046



2x  
6123809



4x  
6117967

7

3

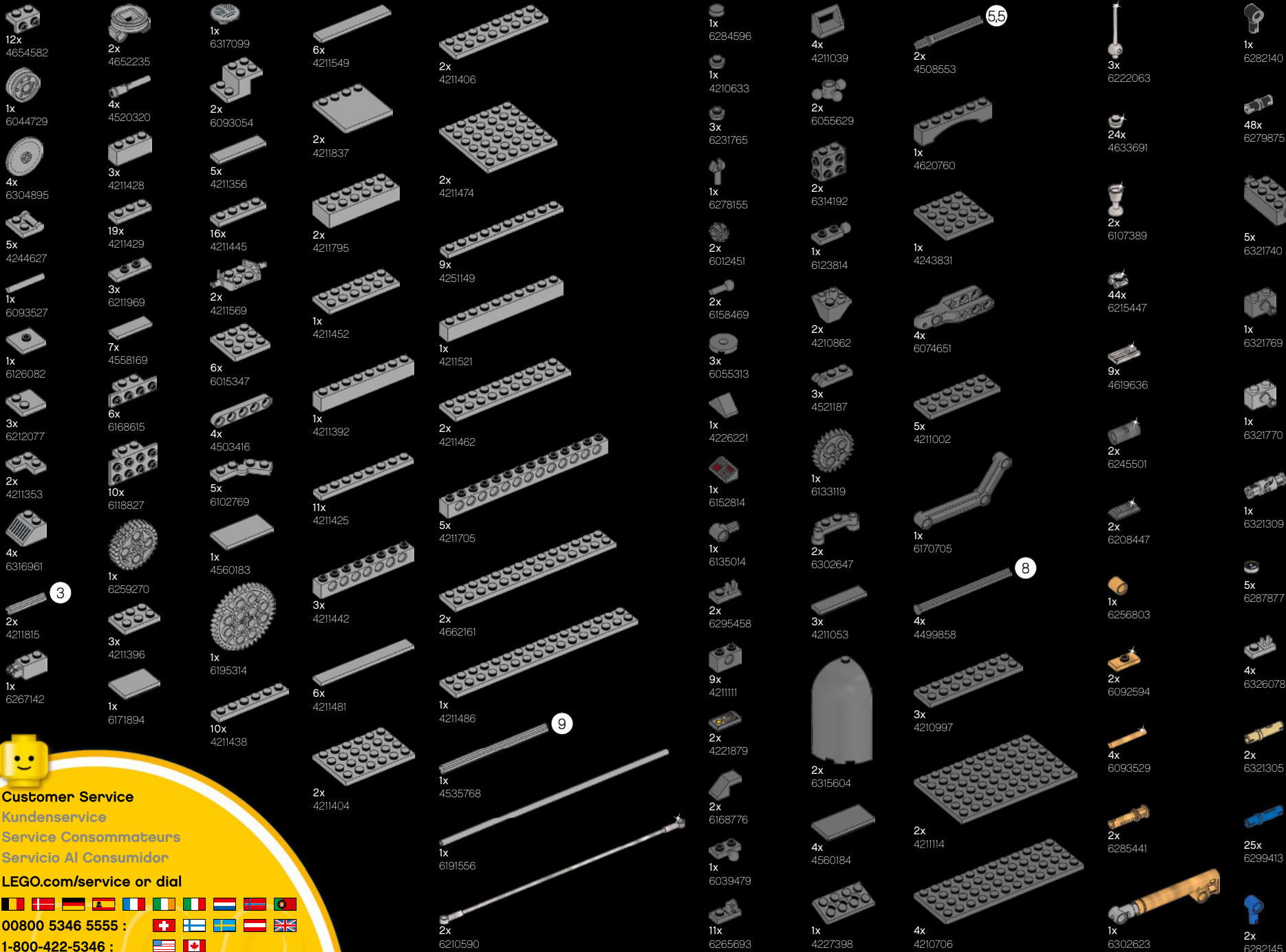

**Customer Service**  
**Kundenservice**  
**Service Consommateurs**  
**Servicio Al Consumidor**  
**LEGO.com/service or dial**



00800 5346 5555 :  
 1-800-422-5346 :



# FEEDBACK AND WIN



## FEEDBACK AND WIN

Your feedback will help shape the future development of this product series.

Please visit:

## FEEDBACK UND GEWINNEN

Dein Feedback trägt zur Weiterentwicklung dieser Produktreihe bei.

Geh auf:

## COMMENTEZ ET GAGNEZ

Vos commentaires nous aideront à concevoir les futurs produits de cette gamme.

Rendez-vous sur :

## COMENTA Y GANA

Tu opinión nos ayudará a dar forma al desarrollo de esta serie de productos en el futuro.

Visita:

## 反馈有奖

您的反馈将有助于我们在今后改进本系列产品。

请访问：

[LEGO.com/productfeedback](https://www.lego.com/productfeedback)

By completing, you will automatically enter a drawing to win a LEGO® set.

Terms & Conditions apply.

Durch Ausfüllen nimmst du automatisch an der Verlosung eines LEGO® Preises teil.

Es gelten die Teilnahmebedingungen.

En envoyant vos commentaires, vous serez automatiquement inscrit(e) à un tirage au sort qui vous permettra de remporter un prix LEGO®.

Offre soumise à conditions.

Al contestar, participarás automáticamente en el sorteo y podrás ganar un set LEGO®.

Sujeto a Términos y Condiciones.

完成我们的反馈调查，即可自动进入抽奖环节，赢取乐高®套装。

适用《条款和条件》。



OFFICIAL  
LICENSED PRODUCT

6328108